



2

Sensor/actuator cabling and connectors

2019/2020



Terminal blocks

- Terminal blocks

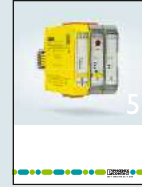

Interface technology and switching devices

- Electronic switching devices and motor control
- Measurement and control technology
- Monitoring
- Relay modules
- System cabling for controllers



Sensor/actuator cabling and connectors

- Sensor/actuator cabling
- Cables and lines
- Connectors



Automation

- PLCnext Technology
- Industrial cloud computing
- Software
- PLCs and I/O systems
- Functional safety
- Industrial communication technology
- HMIs and industrial PCs
- Lighting and signaling



Marking systems, tools, and mounting material

- Marking and labeling
- Tools
- Installation and mounting material



Charging technology for electromobility

- Charging technology for electromobility



Surge protection, power supplies, and device circuit breakers

- Surge protection and interference suppression filters
- Power supplies and UPS
- Protective devices



PCB terminal blocks and PCB connectors

Use our E-paper for quick product selection.

 **Web code: #1517**

Find out more with the web code

For detailed information, use the web codes provided in this brochure. Simply enter # and the four-digit number in the search field on our website.

 **Web code: #1234** (example)

Or use the direct link:

phoenixcontact.net/webcode/#1234







You will find the latest information including all the new products directly in the product area of our website:

phoenixcontact.net/products

You can also use the Phoenix Contact catalog app interactively on your tablet.



Table of contents

Connection technologies from Phoenix Contact We always have the right connection technology for your application		4
Illustrated product range overview Access the right product more quickly from here		6
COMPLETE line The comprehensive solution for the control cabinet		12
Circular connectors Sensor/actuator connectors for assembly in sizes M8 and M12, valve connectors, power connectors in sizes M17 to M58		14
Sensor/actuator cabling Assembled sensor/actuator cables in sizes M8 to M40, valve connectors and distributors in sizes M5 to M40		184
Data connectors and cables Connectors, device connectors, and cables for fieldbuses and networks: M8, M12, RJ45, SC-RJ, D-SUB, and USB		336
Installation systems Panel feed-throughs, cable connectors, connectors, and distributors with Push-in and QUICKON connection for easy installation		464
Heavy-duty connectors HEAVYCON complete connector housings and contact inserts for signal, power, and data transmission		496
Installation and mounting material CES cable entry system for space-saving feed-through, DIN rail mounting frames, cable glands, and service interfaces		674
Technical information General information on the degree of protection, properties of plastics, approvals, insulation coordination, etc.		724
Index		738



Screw connection

The screw connection is the most universal and globally accepted conductor connection technology. An important characteristic is the maintenance-free conductor contact. It is not necessary to retighten the connection screw.

All types of copper wires can be clamped without any pretreatment, thereby making gas-tight and permanent contact.

The wire protection, which protects the individual litz wires from damage, is located between the screw and the conductor.

The wire protection also performs a screw locking function to prevent release due to vibrations and temperature fluctuations.

Splicing protection can be implemented in the form of ferrules.

With a screw connection, several conductors may also be clamped under one screw.

The conductive parts of the screw connections are made from high-grade copper alloys that are resistant to stress cracking and corrosion.

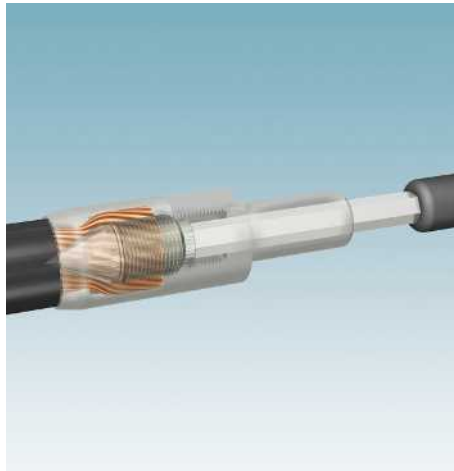

Axial screw connection

With this method, the wire end to be contacted is guided into the connection area of the male or female contact.

A tapered mandrel (part of the contact) is then screwed into the flexible wire from the front. Radial pressure is applied to the strands of the litz wire, pressing them against the contact wall. This results in a gas-tight connection with long-term stability between the wire and contact. It is important that the specified tightening torque is observed.

The mandrel is pressed in using an Allen key which is applied to the front of the contact. This connection technology combines the advantages of screw and crimp connection.

The axial screw connection requires very little space, is easy to use, and only requires a standard Allen key.

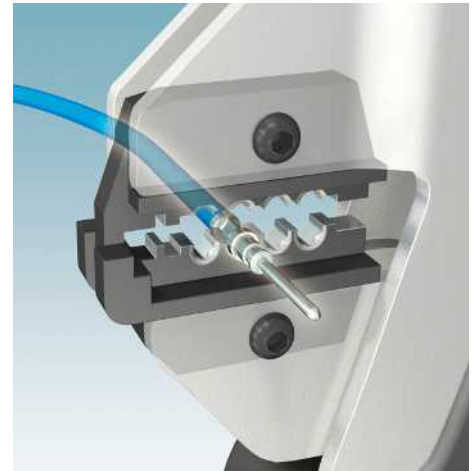

Crimp connection

The crimp connection requires little space and is cost-effective in series production. For a reliable connection, it is essential that the wire cross section, the crimp contact, and the crimping tool are compatible. Since the crimping tools are subject to a certain degree of wear; the crimping process must be monitored during series production.

Crimp connections can be established with the aid of crimping pliers or crimping machines through specific deformation of the crimping area of the contact.

The requirements for crimp connections are defined in DIN EN 60352-2. The quality characteristics of a crimp connection are the tensile strength of the connection and crack-free deformation of the crimp contact. Crimping may not result in impermissible elongation of crimp contacts, as this would prevent them from latching correctly in the contact carrier.

The contact is released using an unlocking tool. Assembly tools are also available for very thin conductors.



Push-in connection for contact inserts

Flexible conductors with ferrules or rigid conductors can be quickly and easily inserted directly into the connection without tools. The contact spring is formed in such a way that it opens automatically when the conductor is pushed in. It thereby provides the required pressure force against the current bar for a gas-tight, vibration-proof, and shock-proof connection.

To release conductors or connect smaller cross sections, the spring is opened by means of the orange push button – this is done easily and without direct contact with live parts.

The conductive metals are made from high-grade copper alloys. All metal parts of the connection are made from corrosion-resistant materials.



Push-Lock connection for circular connectors

Flexible conductors without ferrules can be easily connected using the lever. The terminal point is completely opened by the color lever and remains in this open position. Even small cross sections are easy to insert. The lever must be closed for the connection to be made.

Wire rigid conductors and conductors with ferrules easily and without using tools by means of direct insertion. The contact point does not have to be opened first.

Opening the lever releases a connected conductor. The conductors can be removed with ease.

All metal parts of the connection are made from corrosion-resistant materials.



IDC displacement connection

The QUICKON connection is equipped with an IDC insulation displacement contact. The term “IDC” stands for Insulation Displacement Connection. With this connection method, an unprepared wire with insulation is positioned in front of the gap of the insulation displacement contact and then pushed into the blade gap through insulation displacement. In so doing, the wire insulation is severed and gas-tight contact is made between the wire and the contact. This reduces the time to make a connection by at least 60%.

The connection force is independent of the user and completely reliable provided the permissible conductor cross sections and connection conditions are observed. Rigid and flexible conductors can be rewired up to 10 times. However, the wire end should be cut off before connecting again.

QUICKON connections have proven themselves in numerous applications for Phoenix Contact over recent years, such as connectors, for COMBICON, and terminal blocks, through to CEE plug-in equipment from 0.14 to 6.0 mm².

Circular connectors



M8 connectors, for assembly
Page 16



M12 connectors, for assembly
Page 19



Valve connectors, for assembly
Page 28



M5 and M8 device connectors with litz wires
Page 32



M12 device connectors
With litz wires
With litz wires, square flange
Page 35
Page 42



M17 signal connectors
Page 60



M23 PRO series signal connectors
Page 72



M23 signal connectors
Page 80



M23 feedback connectors
Page 106



M23 hybrid connectors
Page 114



M40 hybrid connectors
Page 122



M17 power connectors
Page 130



M23 PRO series power connectors
Page 142



M23 power connectors
Page 150



M40 power connectors
Page 162



M58 power connectors
Page 170

Sensor/actuator cabling



3-pos. sensor/actuator cables in the sizes M8 and M12

Page 186



4-pos. sensor/actuator cables in the sizes M8 and M12

Page 194



5-pos. sensor/actuator cables in sizes M8 and M12

Page 200



6-pos. sensor/actuator cables in size M8

Page 205



8-pos. sensor/actuator cables in sizes M8 and M12

Page 207



12- and 17-pos. sensor/actuator cables in sizes M12 and M23

Page 212



Cables with plastic molded M17 to M40 signal and power connectors

Page 216



Cables with plastic molded M23 hybrid connectors

Page 226



Cables with valve connector

Page 228



Cables with valve connectors, Deutsch

Page 244



Cables with valve connectors, Superseal

Page 247



M8 and M12 Y-cables

Page 248



M8 and M12 Y/T-distributors

Page 252



M8 and M12 adapters

Page 254



Valve connector adapters

Page 256



M8 distributor boxes with metal thread

Page 260

Sensor/actuator cabling and connectors

Illustrated product range overview

Sensor/actuator cabling



M12 distributor boxes with plastic and metal thread
Page 262



Distributor boxes with QUICKON fast connection
Page 266



Cabling for the railway industry
Page 268



Cabling for the food industry
Page 270



Cabling for outdoor applications
Page 272



Cabling for robots and drag chains
Page 274



M12 cabling for power applications
Page 276



Cable coils
Page 302



Cable drums
Page 303



Accessories
Page 306

Data connectors and cables



M12 connectors for Gigabit Ethernet, for assembly
Page 342



M12 connectors for networks, for assembly
Page 343



Version 6 connectors
Page 350



Version 14 connectors
Page 357



IP20 connectors
Page 372



Accessories for network components
Page 383



Assembled cables with M8 or RJ45 connectors for networks
Page 394



Assembled cables with RJ45 or M12 connectors for networks
Page 396



Assembled fiber optic cables
Page 406



M12 connectors for fieldbuses
Page 422



M12 device connectors for fieldbuses
Page 424



Assembled cables with M8 or M12 connectors for fieldbuses
Page 428



Cables, connectors, and distributors for AS-Interface
Page 438



D-SUB-based fieldbus connectors
Page 444



USB cables, socket inserts, and panel mounting frames, IP67
Page 452

Illustrated product range overview

Installation systems



IPD panel feed-throughs
Page 466



QPD H and T distributors
1.5 mm² Page 472
2.5 mm² Page 481
6.0 mm² Page 489



QPD cable connectors
1.5 mm² Page 474
2.5 mm² Page 483
6.0 mm² Page 491



QPD panel feed-throughs
1.5 mm² Page 476
2.5 mm² Page 484
6.0 mm² Page 492



QPD connectors
1.5 mm² Page 479
2.5 mm² Page 487
6.0 mm² Page 493

Heavy-duty connectors



Contact inserts, D7 series
A3, A4 Page 504
D7, D8, Q7, Q12 Page 506
Q5 Page 508
Q2, Q3, Q4, Q Page 508



D7 series housings
Plastic Page 514
Metal Page 515



Contact inserts, D series
A10 ... A16 Page 518
D15 ... D25 Page 522



D series housings
Plastic Page 524
Metal Page 525

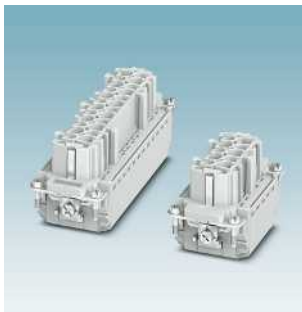

Contact inserts, B series
D40 ... DD108 Page 534
B6 ... BBB64 Page 540
HV03 ... K Page 558



Modular contact inserts, B series
Page 570



Terminal adapters, B series
D40 ... D64 Page 536
B6 ... B24 Page 550



ADVANCE B series housings
Page 596



EVO B series housings
Plastic
Metal
Page 598
Page 599



STANDARD B series housings
Page 600



D7 and B series HPR housings
Page 500



Compact series contact inserts
Page 648



Compact series housings
Page 652



Accessories for contact inserts and housings
Page 654

Installation and mounting material



Modular cable entry system for assembled cables
Page 676



Feed-through plates for non-assembled cables
Page 683



DIN rail mounting frames
Page 684



Cable glands
Page 686



Service interfaces
Page 708

COMPLETE line

The comprehensive solution for the control cabinet

Easy planning, intuitive installation



COMPLETE line is a system comprising technologically leading and coordinated hardware and software products, consulting services, and system solutions that help you optimize your processes in control cabinet manufacturing. Engineering, purchasing, installation, and operation become significantly easier for you.

Your advantages at a glance:

- Intuitive handling, thanks to the uniform design, look, and function
- Time savings across the entire engineering process, thanks to consistent software support
- Reduced logistics costs with standardized accessories and reduced variety of parts
- Optimized processes in control cabinet manufacturing, thanks to custom services and innovative manufacturing solutions

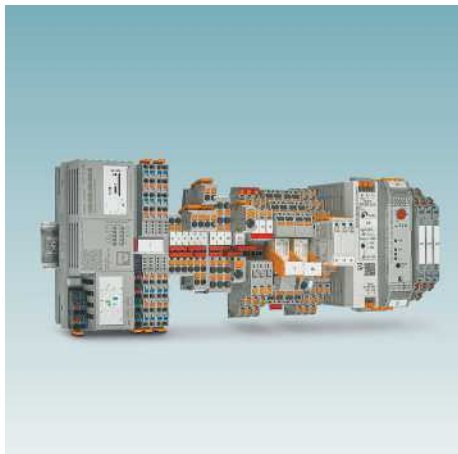

Comprehensive product portfolio

With COMPLETE line, we offer a complete product portfolio of technologically leading products. These include:

- Controllers and I/O modules
- Power supplies and device circuit breakers
- Terminal blocks and distribution blocks
- Relay modules and motor starters
- Signal conditioners
- Safety technology
- Surge protection
- Heavy-duty connectors

Intuitive handling

Thanks to the simple, intuitive handling of the coordinated hardware components, you will save time during installation, startup, and maintenance. Push-in connection technology enables you to wire applications quickly – without using tools. The broad, technologically leading product portfolio will always provide you with the right product for standard or special applications.

Time savings across the entire engineering process

The PROJECT complete planning and marking software supports the entire control cabinet manufacturing process. The program features an intuitive user interface and enables the individual planning, automatic checking, and direct ordering of terminal strips.



Reduced logistics costs

Reduced variety of parts, thanks to standardized marking, bridging, and testing accessories. The COMPLETE line system coordinates products, design, and accessories enabling you to benefit from maximum reusability, thus reducing your logistics costs.

Optimized processes in control cabinet manufacturing

From engineering through to manufacturing, COMPLETE line supports you in making your control cabinet production as efficient as possible, thus creating a customized concept for optimizing your processes in control cabinet manufacturing.

Our terminal strip production helps you to flexibly manage peak order times or to supply your control cabinet production with fully assembled DIN rails just-in-time.

Additional information

Find out more about COMPLETE line and your comprehensive solutions for the control cabinet. Visit our website:

phoenixcontact.com/completeline



Circular connectors

The circular connector range from Phoenix Contact covers the entire scope of industrial applications. From M5 to M58, straight or angled, unshielded or shielded: our extensive portfolio always provides the right connector for your application.

Sensor/actuator connectors

Do you want to wire different cable lengths quickly on site? Our M12 connectors for assembly provide the best connection technology for every application:

- IDC insulation displacement connection
- Push-in connection
- Crimp connection
- Pierce connection
- Screw connection
- Solder connection

Shielded connectors for free assembly are available for more stringent requirements.

Sensor/actuator device connectors

In industrial applications, a wide range of requirements are placed on the sensor/actuator cabling. The products from Phoenix Contact are just as varied. You'll find the right device connector – whether in M5, M8 or M12 format, and for front or rear mounting. Customer-specific developments enable optimum adaptation to your individual device concept.

Signal, feedback, hybrid, and power connectors

The product portfolio for M17 to M58 connectors covers all common applications in industrial environments for signal, hybrid, and power plug-in connections up to 630 V/150 A. This also includes requirements relating to tightness of seal, vibration resistance, and shielding against EMI. A complete choice of plastic-molded connectors rounds off the circular connector range.

 Your web code: [#0368](#)

Sensor/actuator connectors

M8 connectors	16
M12 connectors	19
Valve connectors	28

Sensor/actuator device connectors

M5 device connectors	32
M8 device connectors	33
M12 device connectors	35
Accessories	54

Signal connectors

M17 signal connectors	60
M23 PRO series signal connectors	72
M23 signal connectors	80

Feedback connectors

M23 feedback connectors	106
-------------------------	-----

Hybrid connectors

M23 hybrid connectors	114
M40 hybrid connectors	122

Power connectors

M17 power connectors	130
M23 PRO series power connectors	142
M23 power connectors	150
M40 power connectors	162
M58 power connectors	170

Tools and accessories	176
-----------------------	-----

Screw connection



Unshielded,
3-, 4-pos.



Shielded,
3-, 4-pos.



	Technical data	
	3-pos.	4-pos.
General data	IEC 61076-2-104	
M8 circular connector in accordance with:	3	
Degree of pollution	IP67	
Degree of protection	Screw connection	
Connection method	3.5 mm ... 5 mm	
Cable diameter	0.14 mm ² ... 0.5 mm ²	
Connection cross section [mm ²]		
Electrical data	48 V AC / 60 V DC	
Rated voltage	30 V AC / 30 V DC	
Rated current	4 A	
Insulation resistance	≥ 100 MΩ	
Material data	CuZn / Au	
Material contact/contact surface	PA	
Contact carrier material	HB	
Flammability rating in accordance with UL 94		
Temperature data	-40 ... 85	
Male connector/female connector	[°C]	



	Technical data	
	3-pos.	4-pos.
General data	IEC 61076-2-104	
M8 circular connector in accordance with:	3	
Degree of pollution	IP67	
Degree of protection	Screw connection	
Connection method	3.5 mm ... 5 mm	
Cable diameter	0.14 mm ² ... 0.5 mm ²	
Connection cross section [mm ²]		
Electrical data	48 V AC / 60 V DC	
Rated voltage	30 V AC / 30 V DC	
Rated current	4 A	
Insulation resistance	≥ 100 MΩ	
Material data	CuZn / Au	
Material contact/contact surface	PA	
Contact carrier material	HB	
Flammability rating in accordance with UL 94		
Temperature data	-40 ... 85	
Male connector/female connector	[°C]	

Description	Ordering data			
	Order No.	Pcs./Pkt.	Order No.	Pcs./Pkt.
	3-pos.		4-pos.	
Connector				
Female, straight	1506888	1	1506891	1
Male, straight	1501252	1	1501265	1
Female, angled	1407582	1	1407584	1
Male, angled	1407583	1	1407585	1

Description	Ordering data			
	Order No.	Pcs./Pkt.	Order No.	Pcs./Pkt.
	3-pos.		4-pos.	
Connector				
Female, straight	1542907	1	1542910	1
Male, straight	1542884	1	1542897	1

Accessories			
Pressure screw and seal, for cable diameters:			
2.5 mm ... 3.5 mm	SACC-M 8-SET/2,2-3,5	1436945	5

Accessories			
Pressure screw and seal, for cable diameters:			
2.5 mm ... 3.5 mm			

Circular connectors

M8 sensor/actuator connectors

Solder connection



Unshielded,
3-, 4-pos.



Shielded,
3-, 4-pos.



	Technical data	
	3-pos.	4-pos.
General data		
M8 circular connector in accordance with:	IEC 61076-2-104	
Degree of pollution	3	
Degree of protection	IP67	
Connection method	Solder connection	
Cable diameter	3.5 mm ... 5 mm	
Connection cross section [mm ²]	0.08 mm ² ... 0.25 mm ²	
Electrical data		
Rated voltage	48 V AC / 60 V DC	30 V AC / 30 V DC
Rated current	4 A	
Insulation resistance	≥ 100 MΩ	
Material data		
Material contact/contact surface	CuZn / Au	
Contact carrier material	PA	
Flammability rating in accordance with UL 94	HB	
Temperature data		
Male connector/female connector [°C]	-40 ... 85	



	Technical data	
	3-pos.	4-pos.
General data		
M8 circular connector in accordance with:	IEC 61076-2-104	
Degree of pollution	3	
Degree of protection	IP67	
Connection method	Solder connection	
Cable diameter	3.5 mm ... 5 mm	
Connection cross section [mm ²]	0.08 mm ² ... 0.25 mm ²	
Electrical data		
Rated voltage	48 V AC / 60 V DC	30 V AC / 30 V DC
Rated current	4 A	
Insulation resistance	≥ 100 MΩ	
Material data		
Material contact/contact surface	CuZn / Au	
Contact carrier material	PA	
Flammability rating in accordance with UL 94	HB	
Temperature data		
Male connector/female connector [°C]	-40 ... 85	

Description	Ordering data			
	Order No.	Pcs./Pkt.	Order No.	Pcs./Pkt.
	3-pos.		4-pos.	
Connector				
Female, angled	1529399	1	1513444	1
Male, angled	1699902	1	1554209	1
Female, straight	1681172	1	1681185	1
Male, straight	1681156	1	1681169	1

Description	Ordering data			
	Order No.	Pcs./Pkt.	Order No.	Pcs./Pkt.
	3-pos.		4-pos.	
Connector				
Female, angled	1436479	1	1436482	1
Male, angled	1436453	1	1436466	1
Female, straight	1506927	1	1506930	1
Male, straight	1506901	1	1506914	1

Pressure screw and seal, for cable diameters:	Accessories	
	Order No.	Pcs./Pkt.
2.5 mm ... 3.5 mm	SACC-M 8-SET/2,2-3,5	1436945 5

Pressure screw and seal, for cable diameters:	Accessories	
	Order No.	Pcs./Pkt.
2.5 mm ... 3.5 mm		

Push-in connection

Notes:
M12 connectors for assembly for networks and fieldbuses can be found in the data connectors and cables section from page 337



Unshielded,
4-, 5-pos.



Shielded,
4-, 5-pos.



	Technical data	
	4-pos.	5-pos.
General data		
M12 circular connector in accordance with:	IEC 61076-2-101	
Degree of pollution	3	
Degree of protection	IP65 / IP67	
Connection method	Push-in connection	
Cable diameter	4 mm ... 8 mm	
Connection cross section [mm ²]	0.14 mm ² ... 0.75 mm ²	
Electrical data		
Rated voltage	250 V AC / 250 V DC	48 V AC / 60 V DC
Rated current	4 A	
Insulation resistance	≥ 100 MΩ	
Material data		
Material contact/contact surface	CuSn / Ni/Au	
Contact carrier material	PA 6.6	
Flammability rating in accordance with UL 94	V0	
Temperature data		
Male connector/female connector	-40 ... 85 [°C]	



	Technical data	
	4-pos.	5-pos.
General data		
M12 circular connector in accordance with:	IEC 61076-2-101	
Degree of pollution	3	
Degree of protection	IP65 / IP67	
Connection method	Push-in connection	
Cable diameter	4 mm ... 8 mm	
Connection cross section [mm ²]	0.14 mm ² ... 0.75 mm ²	
Electrical data		
Rated voltage	48 V AC / 60 V DC	
Rated current	4 A	
Insulation resistance	≥ 100 MΩ	
Material data		
Material contact/contact surface	CuSn / Ni/Au	
Contact carrier material	PA 6.6	
Flammability rating in accordance with UL 94	V0	
Temperature data		
Male connector/female connector	-40 ... 85	

Description	Coding	Ordering data			
		4-pos.		5-pos.	
		Order No.	Pcs./Pkt.	Order No.	Pcs./Pkt.
Connector, with metal knurl, color-coded and numbered connection area					
Female, angled	A - standard	1424656	1	1424653	1
Male, angled	A - standard	1424654	1	1424651	1
Female, straight	A - standard	1424655	1	1424652	1
Male, straight	A - standard	1424657	1	1424649	1
Connector, with plastic knurl, color-coded and numbered connection area					
Female, angled	A - standard	1424694	1	1424690	1
Male, angled	A - standard	1424692	1	1424688	1
Female, straight	A - standard	1424693	1	1424689	1
Male, straight	A - standard	1424691	1	1424686	1
Connector, with metal knurl, color-coded and numbered connection area					
Female, angled	B - inverse				
Male, angled	B - inverse				
Female, straight	B - inverse				
Male, straight	B - inverse				

Description	Coding	Ordering data			
		4-pos.		5-pos.	
		Order No.	Pcs./Pkt.	Order No.	Pcs./Pkt.
Connector, with metal knurl, color-coded and numbered connection area					
Female, angled	A - standard	1424669	1	1424661	1
Male, angled	A - standard	1424667	1	1424659	1
Female, straight	A - standard	1424668	1	1424660	1
Male, straight	A - standard	1424666	1	1424658	1
Connector, with plastic knurl, color-coded and numbered connection area					
Female, angled	A - standard				
Male, angled	A - standard				
Female, straight	A - standard				
Male, straight	A - standard				
Connector, with metal knurl, color-coded and numbered connection area					
Female, angled	B - inverse			1424665	1
Male, angled	B - inverse			1424663	1
Female, straight	B - inverse			1424664	1
Male, straight	B - inverse			1424662	1

Insulation displacement connection

Notes:

M12 connectors for assembly for networks and fieldbuses can be found in the data connectors and cables section from page 337



**Unshielded,
4-pos.**



Technical data

	4-pos.	4-pos.
General data	in accordance with IEC 61076-2-101	
M12 circular connector in accordance with:	3	
Degree of pollution	IP65 / IP67	
Degree of protection	Insulation displacement connection	
Connection method	3.5 mm ... 6 mm	4 mm ... 8 mm
Cable diameter	0.14 mm ² ... 0.34 mm ²	0.34 mm ² ... 0.75 mm ²
Connection cross section [mm ²]	125 V AC / 125 V DC	250 V AC / 250 V DC
Electrical data	4 A	
Rated voltage	≥ 100 MΩ	
Rated current	CuSn / Ni/Au	
Insulation resistance	TPU	
Material data	V0	
Material contact/contact surface		
Contact carrier material		
Flammability rating in accordance with UL 94		
Temperature data		
Male connector/female connector [°C]	-25 ... 80	

Ordering data

Description	Coding	4-pos.		4-pos.	
		Order No.	Pcs./Pkt.	Order No.	Pcs./Pkt.
Connector , with plastic knurl, color-coded and numbered connection area					
Female, straight	A - standard	1641701	1	1641756	1
Male, straight	A - standard	1641714	1	1641769	1
Connector , with metal knurl, color-coded and numbered connection area					
Female, straight	A - standard	1641688	1	1641772	1
Male, straight	A - standard	1641691	1	1641785	1
Connector , with stainless steel knurl, color-coded and numbered connection area					
Female, straight	A - standard	1440766	1	1440782	1
Male, straight	A - standard	1440753	1	1440779	1

Insulation displacement connection



Shielded,
4-, 5-, 8-pos.



Shielded,
4-, 5-, 8-pos.

ERC

	Technical data		
	4-pos.	5-pos.	8-pos.
General data	in accordance with IEC 61076-2-101		
M12 circular connector in accordance with:	3		
Degree of pollution	IP65 / IP67		
Degree of protection	Insulation displacement connection		
Connection method	0.14 mm ² ... 0.75 mm ² 0.14 mm ² ... 0.5 mm ²		
Connection cross section [mm ²]	250 V AC / 250 V DC 48 V AC / 60 V DC 30 V AC / 30 V DC		
Electrical data	4 A 2 A		
Rated voltage	≥ 100 MΩ		
Rated current	Material data		
Insulation resistance	CuSn / Ni/Au		
Material data	PA 6.6		
Material contact/contact surface	V0		
Contact carrier material	Flammability rating in accordance with UL 94		
Flammability rating in accordance with UL 94	Temperature data		
Temperature data	-40 ... 85		
Male connector/female connector	[°C]		

ERC

	Technical data		
	4-pos.	5-pos.	8-pos.
General data	-		
M12 circular connector in accordance with:	3		
Degree of pollution	IP65 / IP67		
Degree of protection	Insulation displacement connection		
Connection method	0.14 mm ² ... 0.75 mm ² 0.14 mm ² ... 0.5 mm ²		
Connection cross section [mm ²]	250 V AC / 250 V DC 48 V AC / 60 V DC 30 V AC / 30 V DC		
Electrical data	4 A 2 A		
Rated voltage	≥ 100 MΩ		
Rated current	Material data		
Insulation resistance	CuSn / Ni/Au		
Material data	PA 6.6		
Material contact/contact surface	V0		
Contact carrier material	Flammability rating in accordance with UL 94		
Flammability rating in accordance with UL 94	Temperature data		
Temperature data	-40 ... 85		
Male connector/female connector	[°C]		

Description	Coding	Ordering data					
		Order No.	Pcs./Pkt.	Order No.	Pcs./Pkt.	Order No.	Pcs./Pkt.
Connector , shielded, with metal knurl, color-coded and numbered connection area, cable diameter: 5 mm ... 9.7 mm		4-pos.		5-pos.		8-pos.	
Female, straight	A - standard	1413994	1	1413992	1	1414611	1
Male, straight	A - standard	1413993	1	1413991	1	1414610	1

Description	Coding	Ordering data					
		Order No.	Pcs./Pkt.	Order No.	Pcs./Pkt.	Order No.	Pcs./Pkt.
Connector , shielded, with metal knurl, color-coded and numbered connection area, cable diameter: 5 mm ... 9.7 mm		4-pos.		5-pos.		8-pos.	
Female, straight	A - standard	1414418	1	1414417	1	1414612	1
Male, straight	A - standard	1414419	1	1414416	1	1414611	1

Description	Coding	Ordering data					
		Order No.	Pcs./Pkt.	Order No.	Pcs./Pkt.	Order No.	Pcs./Pkt.
Cable connector , shielded, color-coded and numbered connection area, cable diameter: 5 mm ... 9.7 mm		4-pos.		5-pos.		8-pos.	
Female, straight	A - standard	1413994	1	1413992	1	1414611	1
Male, straight	A - standard	1413993	1	1413991	1	1414610	1

Description	Coding	Ordering data					
		Order No.	Pcs./Pkt.	Order No.	Pcs./Pkt.	Order No.	Pcs./Pkt.
Cable connector , shielded, color-coded and numbered connection area, cable diameter: 5 mm ... 9.7 mm		4-pos.		5-pos.		8-pos.	
Female, straight	A - standard	1414418	1	1414417	1	1414612	1
Male, straight	A - standard	1414419	1	1414416	1	1414611	1

Circular connectors

M12 sensor/actuator connectors

Screw connection

Notes:
M12 connectors for assembly for networks and fieldbuses can be found in the data connectors and cables section from page 337



Plastic knurl,
4, 5-pos.



Metal knurl,
4, 5, 8-pos.



Technical data	
4-pos.	5-pos.
General data	
M12 circular connector in accordance with:	
Degree of pollution	
Degree of protection	
Connection method	
Connection cross section [mm ²]	
Electrical data	
Rated voltage	
Rated current	
Insulation resistance	
Material data	
Material contact/contact surface	
Contact carrier material	
Flammability rating in accordance with UL 94	
Temperature data	
Male connector/female connector	[°C]

Technical data	
4-pos.	5-pos.
IEC 61076-2-101	
3	
IP67	
Screw connection	
0.25 mm ² ... 0.75 mm ²	
250 V AC / 250 V DC	48 V AC / 60 V DC
4 A	
≥ 100 MΩ	
CuZn / CuSnZn	
PA	
HB	
-40 ... 85	

Technical data		
4-pos.	5-pos.	8-pos.
IEC 61076-2-101		
3		
IP67		
Screw connection		
0.25 mm ² ... 0.75 mm ²		0.25 mm ² ... 0.5 mm ²
250 V AC / 250 V DC	48 V AC / 60 V DC	30 V AC / 30 V DC
4 A		2 A
≥ 100 MΩ		
CuZn / CuSnZn		CuZn / Au
PA		
HB		
-40 ... 85		

Ordering data	
Description	Coding

Order No.	Pcs./Pkt.	Order No.	Pcs./Pkt.	Order No.	Pcs./Pkt.
4-pos.		5-pos.			

Order No.	Pcs./Pkt.	Order No.	Pcs./Pkt.	Order No.	Pcs./Pkt.
4-pos.		5-pos.		8-pos.	

Connector, with Pg7 screw connection, cable diameter: 4 mm ... 6 mm	
Female, angled	A - standard
Male, angled	A - standard
Female, straight	A - standard
Male, straight	A - standard

1681130	1	1662308	1		
1681091	1	1662269	1		
1681114	1	1662298	1		
1681088	1	1662256	1		

1681143	1	1662984	1		
1681101	1	1663129	1		
1681127	1	1662968	1		
1662528	1	1663116	1		

Connector, with Pg9 screw connection, cable diameter: 6 mm ... 8 mm	
Female, angled	A - standard
Male, angled	A - standard
Female, straight	A - standard
Male, straight	A - standard

		1500790	1		
		1513431	1		
		1500787	1		
		1500774	1		

		1681499	1		
		1681473	1		
1696439	1	1681486	1	1513347	1
1523230	1	1681460	1	1513334	1

Connector, with Pg11 screw connection, cable diameter: 8 mm ... 10 mm	
Female, straight	A - standard
Male, straight	A - standard

				1410665	1
				1410666	1

				1410665	1
				1410666	1

Power connector, with Pg11 screw connection, cable diameter: 8 mm ... 10 mm, rated current: up to 8 A (5th pos. max. 2 A) with 1.5 mm² wires/litz wires	
Female, angled	A - standard
Male, angled	A - standard
Female, straight	A - standard
Male, straight	A - standard

		1408991	1	1408993	1
		1408990	1	1408992	1
		1404416	1	1404418	1
		1404415	1	1404417	1

		1408991	1	1408993	1
		1408990	1	1408992	1
		1404416	1	1404418	1
		1404415	1	1404417	1

Accessories	
Pressure screw and seal, for connectors with Pg7 screw connection, for cable diameters:	
2.5 mm ... 3.5 mm	

SACC-M12-SET/2,5-3,5	1436505	5
----------------------	---------	---

SACC-M12-SET/2,5-3,5	1436505	5
----------------------	---------	---

Screw connection

Notes:
M12 connectors for assembly for networks and fieldbuses can be found in the data connectors and cables section from page 337



Metal knurl, 4, 5-pos., with SKINTOP® screw connection



Stainless steel knurl, 4, 5-pos.

ERIC

ERIC

	Technical data	
	4-pos.	5-pos.
General data	IEC 61076-2-101	
M12 circular connector in accordance with:	3	
Degree of pollution	IP67	
Degree of protection	Screw connection	
Connection method	0.25 mm ² ... 0.75 mm ²	
Connection cross section [mm ²]	250 V AC / 250 V DC	48 V AC / 60 V DC
Electrical data	4 A	
Rated voltage	≥ 100 MΩ	
Rated current	CuZn / CuSnZn	
Insulation resistance	PA	
Material data	HB	
Material contact/contact surface		
Contact carrier material		
Flammability rating in accordance with UL 94		
Temperature data	-20 ... 80	
Male connector/female connector	[°C]	

	Technical data	
	4-pos.	5-pos.
General data	IEC 61076-2-101	
M12 circular connector in accordance with:	3	
Degree of pollution	IP65/IP67/IP69K	
Degree of protection	Screw connection	
Connection method	0.25 mm ² ... 0.75 mm ²	
Connection cross section [mm ²]	250 V AC / 250 V DC	48 V AC / 60 V DC
Electrical data	4 A	
Rated voltage	≥ 100 MΩ	
Rated current	CuZn / Au	
Insulation resistance	PA	
Material data	-	
Material contact/contact surface		
Contact carrier material		
Flammability rating in accordance with UL 94		
Temperature data	-40 ... 85	
Male connector/female connector	[°C]	

Description	Coding	Ordering data			
		4-pos.		5-pos.	
		Order No.	Pcs./Pkt.	Order No.	Pcs./Pkt.
Connector, with Pg7 screw connection, cable diameter: 4 mm ... 6 mm					
Female, angled	A - standard				
Male, angled	A - standard				
Female, straight	A - standard	1430381	1	1559000	1
Male, straight	A - standard	1556870	1	1456466	1
Connector, with Pg9 screw connection, cable diameter: 6 mm ... 8 mm					
Female, angled	A - standard			1556812	1
Male, angled	A - standard			1561742	1
Female, straight	A - standard			1556838	1
Male, straight	A - standard			1556825	1

Description	Coding	Ordering data			
		4-pos.		5-pos.	
		Order No.	Pcs./Pkt.	Order No.	Pcs./Pkt.
Connector, with Pg7 screw connection, cable diameter: 4 mm ... 6 mm					
Female, angled	A - standard	1553284	1	1553297	1
Male, angled	A - standard	1553200	1	1553213	1
Female, straight	A - standard	1553242	1	1553255	1
Male, straight	A - standard	1553161	1	1553187	1
Connector, with Pg9 screw connection, cable diameter: 6 mm ... 8 mm					
Female, angled	A - standard			1553307	1
Male, angled	A - standard	1553226	1	1553239	1
Female, straight	A - standard	1553268	1	1553271	1
Male, straight	A - standard	1553174	1	1553190	1

Accessories		
Pressure screw and seal, for connectors with Pg7 screw connection, for cable diameters:		
2.5 mm ... 3.5 mm		

Accessories		
SACC-M12-SET/2,5-3,5	1436505	5

DUO connectors, screw connection

Notes:
Plastic knurl without wrench flats.



**Metal knurl,
4-, 5-pos.**



**Plastic and stainless steel knurl,
5-pos.**



	Technical data	
	4-pos.	5-pos.
General data	IEC 61076-2-101	
M12 circular connector in accordance with:	3	
Degree of pollution	IP67	
Degree of protection	Screw connection	
Connection method	2x 2.1 mm ... 3 mm (when using the seal for small outer cable diameters)	
Cable diameter	2x 4 mm ... 5.2 mm (when using the seal for large outer cable diameters)	
Cable diameter	0.25 mm ² ... 0.75 mm ²	
Connection cross section [mm ²]		
Electrical data	250 V AC / 250 V DC	
Rated voltage	48 V AC / 60 V DC	
Rated current	4 A	
Insulation resistance	≥ 100 MΩ	
Material data	CuZn / CuSnZn	
Material contact/contact surface	PA	
Contact carrier material	-	
Flammability rating in accordance with UL 94	-	
Temperature data	-40 ... 85	
Male connector/female connector	[°C]	



	Technical data	
	Plastic knurl	Stainless steel knurl
General data	IEC 61076-2-101	
M12 circular connector in accordance with:	3	
Degree of pollution	IP67	
Degree of protection	Screw connection	
Connection method	2x 2.1 mm ... 3 mm (when using the seal for small outer cable diameters)	
Cable diameter	2x 4 mm ... 5.2 mm (when using the seal for large outer cable diameters)	
Cable diameter	0.25 mm ² ... 0.75 mm ²	
Connection cross section [mm ²]		
Electrical data	250 V AC / 250 V DC	
Rated voltage	48 V AC / 60 V DC	
Rated current	4 A	
Insulation resistance	≥ 100 MΩ	
Material data	CuZn / CuSnZn	
Material contact/contact surface	PA	CuZn / Au
Contact carrier material	-	
Flammability rating in accordance with UL 94	-	
Temperature data	-40 ... 85	
Male connector/female connector	[°C]	

Description	Coding	Ordering data			
		Order No.	Pcs./Pkt.	Order No.	Pcs./Pkt.
		4-pos.		5-pos.	
Connector, with metal knurl, for connecting two cables					
Male, straight	A - standard	1507052	1	1662748	1
Connector, with plastic knurl, for connecting two cables					
Female, straight	A - standard				
Male, straight	A - standard				
Male, angled	A - standard				
Connector, with stainless steel knurl, for connecting two cables					
Female, straight	A - standard				
Male, straight	A - standard				

Description	Coding	Ordering data			
		Order No.	Pcs./Pkt.	Order No.	Pcs./Pkt.
		Plastic knurl		Stainless steel knurl	
Connector, with metal knurl, for connecting two cables					
Female, straight	A - standard	1694596	1		
Male, straight	A - standard	1662285	1		
Male, angled	A - standard	1531044	1		
Connector, with stainless steel knurl, for connecting two cables					
Female, straight	A - standard			1403372	1
Male, straight	A - standard			1403371	1

Circular connectors

M12 sensor/actuator connectors

Solder and Piercecon® connection



Solder connection,
12-pos.



Piercecon® connection,
12, 17-pos.

UL US ERC

ERC

	Technical data				Technical data				
	unshielded		shielded		12-pos.		17-pos.		
General data									
M12 circular connector in accordance with:	IEC 61076-2-101				IEC 61076-2-101				
Degree of pollution	3				3				
Degree of protection	IP67				IP67				
Connection method	Solder connection				Piercecon® fast connection				
Cable diameter	6 mm ... 8 mm				5.4 mm ... 8.2 mm				
Connection cross section [mm ²]	0.08 mm ² ... 0.25 mm ²				0.14 mm ² ... 0.14 mm ²				
Electrical data									
Rated voltage	30 V AC / 30 V DC				30 V AC / 30 V DC				
Rated current	1.5 A (up to 40°C)				1.5 A				
Insulation resistance	> 10 GΩ				≥ 100 MΩ				
Material data									
Material contact/contact surface	CuZn / Au				CuZn / Ni/Au				
Contact carrier material	PA				PA				
Flammability rating in accordance with UL 94	HB				V0				
Temperature data									
Male connector/female connector	-40 ... 85				-25 ... 85				
	Ordering data				Ordering data				
Description	Coding	unshielded		shielded		12-pos.		17-pos.	
		Order No.	Pcs./Pkt.	Order No.	Pcs./Pkt.	Order No.	Pcs./Pkt.	Order No.	Pcs./Pkt.
Connector									
Female, angled	A - standard	1404423	1	1404413					
Male, angled	A - standard	1404421	1	1404412					
Female, straight	A - standard	1404420	1	1404411					
Male, straight	A - standard	1404419	1	1404410					
Connector, unshielded, color-coded connection area									
Female, straight	A - standard				1559631	1	1559644	1	
Male, straight	A - standard				1559592	1	1559602	1	

Crimp connection, shielded



4-, 5-, 8-pos.



Push-pull locking,
4-, 5-, 8-pos.

ERC

	Technical data		
	4-pos.	5-pos.	8-pos.
General data	M12 circular connector in accordance with: IEC 61076-2-101		
Connection method	M12		
Degree of pollution	3		
Degree of protection	IP65 / IP67		
Connection method	Crimp connection		
Cable diameter	4.5 mm ... 7.5 mm	6.5 mm ... 10 mm	
Electrical data	48 V AC / 60 V DC		
Rated voltage	48 V AC / 60 V DC		
Rated current	4 A	0.5 A	
Insulation resistance	≥ 100 Ω		
Material data	PA 6.6		
Contact carrier material	Zinc die-cast, nickel-plated		
Material, knurls	V0		
Flammability rating in accordance with UL 94	V0		
Temperature data	-40 ... 85		
Male connector/female connector	[°C]		

ERC

	Technical data		
	4-pos.	5-pos.	8-pos.
General data	M12 circular connector in accordance with: IEC 61076-2-109		
Connection method	M12 push-pull		
Degree of pollution	3		
Degree of protection	IP65 / IP67 / IP68 / IP69K		
Connection method	Crimp connection		
Cable diameter	4.5 mm ... 7.5 mm	6.5 mm ... 10 mm	
Electrical data	48 V AC / 60 V DC		
Rated voltage	48 V AC / 60 V DC		
Rated current	4 A	0.5 A	
Insulation resistance	≥ 100 Ω		
Material data	PA 6.6		
Contact carrier material	Zinc die-cast, nickel-plated		
Material, knurls	V0		
Flammability rating in accordance with UL 94	V0		
Temperature data	-40 ... 85		
Male connector/female connector	[°C]		

	Coding	Ordering data					
		Order No.	Pcs./ Pkt.	Order No.	Pcs./ Pkt.	Order No.	Pcs./ Pkt.
Connector , without contacts, color-coded and numbered contact manager							
Female, angled	D - data	1422849	1				
Male, angled	D - data	1422847	1				
Female, straight	D - data	1422848	1				
Male, straight	D - data	1422846	1				
Connector , without contacts, color-coded and numbered contact manager							
Female, angled	A - standard		1422853	1			
Male, angled	A - standard		1422851	1			
Female, straight	A - standard		1422852	1			
Male, straight	A - standard		1422850	1			
Connector , without contacts, color-coded contact manager							
Male, angled	X - data				1422845	1	1021784
Male, straight	X - data				1422844	1	1021783

	Coding	Ordering data					
		Order No.	Pcs./ Pkt.	Order No.	Pcs./ Pkt.	Order No.	Pcs./ Pkt.
Connector , without contacts, color-coded and numbered contact manager							
Female, angled	D - data	1021831	1				
Male, angled	D - data	1021830	1				
Connector , without contacts, color-coded and numbered contact manager							
Female, angled	A - standard					1021816	1
Male, angled	A - standard					1021815	1
Female, straight	A - standard						
Male, straight	A - standard						
Connector , without contacts, color-coded contact manager							
Male, angled	X - data						1021784
Male, straight	X - data						1021783

Accessories			
CC1,0-TS-0,34F AU	1064041	100	
CC1,0-TS-1,00F AU	1423646	100	
CC1,0-TS-0,34M AU	1064040	100	
CC1,0-TS-1,00M AU	1423645	100	
CC0,6-TS-0,34M AU	1423643	100	
CRIMPFOX-TC MP	1212510	1	

Accessories			
CC1,0-TS-0,34M AU	1064040	100	
CC1,0-TS-1,00M AU	1423645	100	
CC0,6-TS-0,34M AU	1423643	100	
CRIMPFOX-TC MP	1212510	1	

Crimp contact , turned, gold-plated	
Female, for A/D-coded, 0.14 mm ² ... 0.34 mm ²	
Female, for A/D-coded, 0.34 mm ² ... 1.0 mm ²	
Male, for A/D-coded, 0.14 mm ² ... 0.34 mm ²	
Male, for A/D-coded, 0.34 mm ² ... 1.0 mm ²	
Male, for X-coded, 0.14 mm ² ... 0.34 mm ²	
Crimping pliers , for turned contacts, universal cross section setting, up to a maximum of 2.5 mm ² , digital display with 0.01 mm increments, unlockable pressure lock, lateral entry, including positioning tool	
for turned contacts, four-mandrel crimping	

Circular connectors

Valve connectors

Valve connectors, type A, screw connection



Without protective circuit



Protective circuit: varistor

ERC

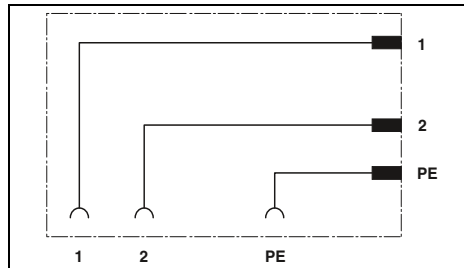

ERC

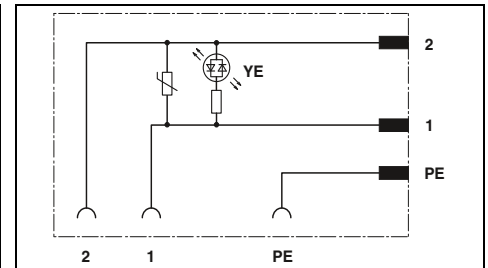

Technical data

General data	
Valve connector in accordance with:	EN 175301-803
Degree of pollution	3
Degree of protection	IP65
Connection method	Screw connection
Electrical data	
Rated current	10 A
Insulation resistance	> 2 GΩ
Material data	
Material contact valve connector	CuZn
Material contact surface valve connector	CuSn
Flammability rating in accordance with UL 94	HB
Temperature data	
Valve connectors	[°C] -25 ... 60

General data	
Valve connector in accordance with:	EN 175301-803
Degree of pollution	3
Degree of protection	IP65
Connection method	Screw connection
Electrical data	
Rated current	1.5 A
Insulation resistance	> 2 GΩ
Material data	
Material contact valve connector	CuZn
Material contact surface valve connector	CuSn
Flammability rating in accordance with UL 94	HB
Temperature data	
Valve connectors	[°C] -25 ... 60

Ordering data

Description	Type	Order No.	Pcs./Pkt.
Valve connector , without protective circuit, rated voltage: 230 V			
3-pos.	SACC-VB-3CON-M16/A	1452123	1
4-pos.	SACC-VB-4CON-M16/A	1452136	1
Valve connector , with protective circuit, rated voltage:			
24 V			
110 V			
230 V			
Valve connector , 5-pos., type A for pressure switch, 2 LEDs, without protective circuit, M16 cable gland, rated voltage:			
24 V			
Valve connector , with protective circuit, rated voltage: 24 V, cable gland:			
Pg9			
M16			

Type	Order No.	Pcs./Pkt.

Technical data

General data	
Valve connector in accordance with:	EN 175301-803
Degree of pollution	3
Degree of protection	IP65
Connection method	Screw connection
Electrical data	
Rated current	1.5 A
Insulation resistance	> 2 GΩ
Material data	
Material contact valve connector	CuZn
Material contact surface valve connector	CuSn
Flammability rating in accordance with UL 94	HB
Temperature data	
Valve connectors	[°C] -25 ... 60

Ordering data

Type	Order No.	Pcs./Pkt.



Protective circuit: varistor and rectifier



Pressure switch



Protective circuit: Z diode

ERC

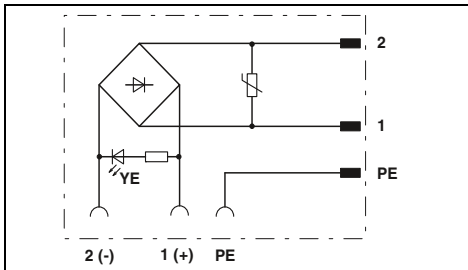

Technical data

EN 175301-803
3
IP65
Screw connection

1.5 A
> 2 GΩ

CuZn
CuSn
HB

-25 ... 60

Ordering data

Type	Order No.	Pcs./Pkt.
SACC-VB-3CON-M16/A-GVL 12/24V	1452178	1
SACC-VB-3CON-M16/A-GVL 110V	1452181	1
SACC-VB-3CON-M16/A-GVL 230V	1452194	1

ERC

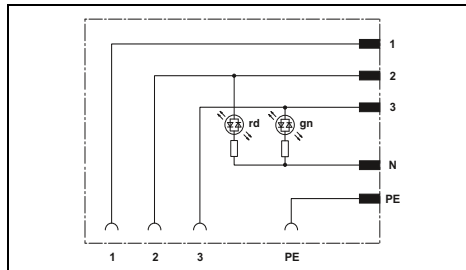

Technical data

EN 175301-803
3
IP65
Screw connection

1.5 A
> 2 GΩ

CuZn
CuSn
HB

-25 ... 60

Ordering data

Type	Order No.	Pcs./Pkt.
SACC-VB-5CON-M16/AD-2L 24V	1457908	1

ERC

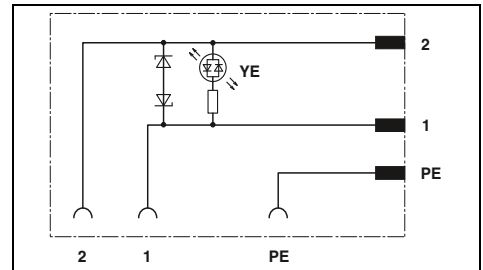

Technical data

EN 175301-803
3
IP65
Screw connection

4 A
> 2 GΩ

CuSn
Ag
HB

-25 ... 60

Ordering data

Type	Order No.	Pcs./Pkt.
SACC-V-3CON-PG9/A-1L-S	1671137	1
SACC-V-3CON-M16/A-1L-S	1544714	1

Circular connectors

Valve connectors

Valve connectors, types B and BI, screw connection



Protective circuit: Z diode



Protective circuit: varistor

ERC

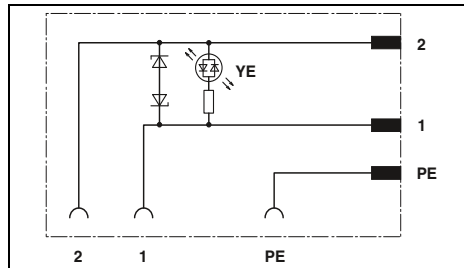

ERC

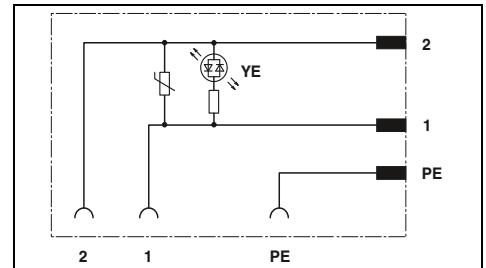

Technical data

Type B	Type BI
EN 175301-803	-
3	-
IP65	-
Screw connection	-
4 A	-
> 2 GΩ	-
Ag	-
PA	-
HB	-
-25 ... 60	-

Technical data

Type B	Type BI
EN 175301-803	-
3	-
IP65	-
Screw connection	-
1.5 A	-
> 2 GΩ	-
CuSn	-
PA	-
HB	-
-25 ... 60	-

General data	
Valve connector in accordance with:	
Degree of pollution	
Degree of protection	
Connection method	
Electrical data	
Rated current	
Insulation resistance	
Material data	
Material contact surface valve connector	
Material housing valve connector	
Flammability rating in accordance with UL 94	
Temperature data	
Valve connectors	[°C]

Ordering data

Order No.	Pcs./Pkt.	Order No.	Pcs./Pkt.
Type B		Type BI	
1671153	1	1671140	1

Ordering data

Order No.	Pcs./Pkt.	Order No.	Pcs./Pkt.
Type B		Type BI	
1452204	1	1452233	1
1452217	1	1452246	1
1452220	1	1452259	1

Description	
Valve connector, 3-pos., with protective circuit, cable gland Pg9, rated voltage:	
24 V	
Valve connector, with protective circuit, yellow LED, rated voltage:	
24 V	
110 V	
230 V	

Valve connectors, type C and CI, screw connection



Protective circuit: varistor

ERC

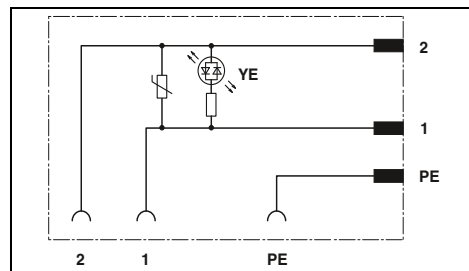

Technical data

General data	Type C	Type CI
	Valve connector in accordance with:	EN 175301-803
Degree of pollution		3
Degree of protection		IP65
Connection method		Screw connection
Electrical data		
Rated current		1.5 A
Insulation resistance		> 2 GΩ
Material data		
Material contact valve connector		CuZn
Material contact surface valve connector		CuSn
Flammability rating in accordance with UL 94		HB
Temperature data		
Valve connectors [°C]		-25 ... 60

Ordering data

Description	Order No.	Pcs./Pkt.	Order No.	Pcs./Pkt.
	Type C		Type CI	
Valve connector, with protective circuit, yellow LED, rated voltage:				
24 V	1452262	1	1452291	1
110 V	1452275	1	1452301	1
230 V	1452288	1	1452314	1

Circular connectors

M5 sensor/actuator device connectors, front mounting

M5 fastening thread, with 0.5 m long litz wires

Notes:

Flat nut recommended for housing wall thicknesses < 2.5 mm.



**M5,
3-, 4-pos.**

ERC

Technical data

	3-pos.	4-pos.
General data		
M5 circular connector in accordance with:	IEC 61076-2-105	IEC 61076-2-105
Degree of pollution	3	3
Degree of protection	IP67	IP67
Connection method	Individual wires	Individual wires
Electrical data		
Rated voltage	60 V	60 V
Rated current	1 A	1 A
Material data		
Material contact/contact surface	CuSn / Au	CuSn / Au
Contact carrier material	PA 6.6	PA 6.6
Flammability rating in accordance with UL 94	HB	HB
Cable type	TPE litz wire	TPE litz wire
Temperature data		
Male connector/female connector [°C]	-25 ... 85	-25 ... 85

Ordering data

Description	Coding	3-pos.		4-pos.	
		Order No.	Pcs./Pkt.	Order No.	Pcs./Pkt.
Device connector					
Female	A - standard	1530605	1	1530618	1
Male	A - standard	1530582	1	1530595	1

Accessories

Flat nut, with:			
M5 thread	SACC-E-MU-M 5	1535901	100

**M8 fastening thread,
with 0.5 m long litz wires**



**M8,
3-, 4-, 5-pos.**



**M8,
6-, 8-pos.**



	Technical data		
	3-pos.	4-pos.	5-pos.
General data			
M8 circular connector in accordance with:	IEC 61076-2-104	IEC 61076-2-104	IEC 61076-2-104
Degree of pollution	3	3	3
Degree of protection	IP67	IP67	IP67
Connection method	Individual wires	Individual wires	Individual wires
Electrical data			
Rated voltage	50 V AC / 60 V DC	50 V AC / 60 V DC	30 V AC / 30 V DC
Rated current	4 A	4 A	3 A
Material data			
Material contact/contact surface	Cu alloy / Au	Cu alloy / Au	Cu alloy / Au
Contact carrier material	PA 6.6	PA 6.6	PA 6.6
Flammability rating in accordance with UL 94	HB	HB	HB
Cable type	PVC litz wire	PVC litz wire	PVC litz wire
Temperature data			
Male connector/female connector	-25 ... 85	-25 ... 85	-25 ... 85



	Technical data	
	6-pos.	8-pos.
General data		
M8 circular connector in accordance with:	IEC 61076-2-104	IEC 61076-2-104
Degree of pollution	3	3
Degree of protection	IP67	IP67
Connection method	Individual wires	Individual wires
Electrical data		
Rated voltage	30 V AC / 30 V DC	30 V AC / 30 V DC
Rated current	2 A	1.5 A
Material data		
Material contact/contact surface	Cu alloy / Au	Cu alloy / Au
Contact carrier material	PA 6.6	PA 6.6
Flammability rating in accordance with UL 94	HB	HB
Cable type	PVC litz wire	PVC litz wire
Temperature data		
Male connector/female connector	-25 ... 85	-25 ... 85

Description	Coding	Ordering data					
		3-pos.		4-pos.		5-pos.	
		Order No.	Pcs./Pkt.	Order No.	Pcs./Pkt.	Order No.	Pcs./Pkt.
Device connector							
Female	A - standard	1500350	1	1500363	1		
Male	A - standard	1500334	1	1500347	1		
Female	B - inverse					1424233	1
Male	B - inverse					1424234	1
Flat nut, with:							
M8 thread		1504071	100	1504071	100		

Description	Coding	Ordering data			
		6-pos.		8-pos.	
		Order No.	Pcs./Pkt.	Order No.	Pcs./Pkt.
Device connector					
Female	A - standard	1542677	1	1424231	1
Male	A - standard	1542664	1	1424232	1
Female	B - inverse				
Male	B - inverse				
Flat nut, with:					
M8 thread		1504071	100		

Circular connectors

M8 sensor/actuator device connectors, rear mounting

M8, M10, M12 fastening thread, with 0.5 m long litz wires



3-, 4-pos.



6, 8-pos.



Technical data

General data	
M8 circular connector in accordance with:	
Degree of pollution	3
Degree of protection	IP67
Connection method	Individual wires
Electrical data	
Rated voltage	50 V AC / 60 V DC
Rated current	4 A
Material data	
Material contact/contact surface	Cu alloy / Au
Contact carrier material	PUR / PA 6.6
Flammability rating in accordance with UL 94	HB
Cable type	PVC litz wire
Temperature data	
Male connector/female connector	[°C] -25 ... 85

3-pos.		4-pos.	
IEC 61076-2-104			
3			
IP67			
Individual wires			
50 V AC / 60 V DC		50 V AC / 60 V DC	
4 A		4 A	
Cu alloy / Au		Cu alloy / Au	
PUR / PA 6.6		PUR / PA 6.6	
HB		HB	
PVC litz wire		PVC litz wire	
-25 ... 85		-25 ... 85	



Technical data

6-pos.		8-pos.	
IEC 61076-2-104			
3			
IP67			
Individual wires			
30 V AC / 30 V DC		30 V AC / 30 V DC	
2 A		1.5 A	
Cu alloy / Au		Cu alloy / Au	
PUR / PA 6.6		PUR / PA 6.6	
HB		HB	
PVC litz wire		PVC litz wire	
-25 ... 85		-25 ... 85	

Ordering data

Description	Coding
Device connector, M8 fastening thread	
Male	A - standard
Device connector, M10 fastening thread	
Female	A - standard
Device connector, M12 fastening thread	
Female	A - standard

3-pos.		4-pos.	
Order No.	Pcs./Pkt.	Order No.	Pcs./Pkt.
1453478	1	1453481	1
1456080	1	1456093	1
1453449	1	1453452	1

Ordering data

6-pos.		8-pos.	
Order No.	Pcs./Pkt.	Order No.	Pcs./Pkt.
1453494	1	1424230	1
1456103	1	1424229	1
1453465	1		

M12 sensor/actuator device connectors, front mounting

Pg9 fastening thread, with 0.5 m long litz wires



4-, 5-, 8-pos.



can be positioned, 4-, 5-, 8-pos.



	Technical data		
	4-pos.	5-pos.	8-pos.
General data			
M12 circular connector in accordance with:	IEC 61076-2-101	IEC 61076-2-101	IEC 61076-2-101
Degree of pollution	3	3	3
Degree of protection	IP67	IP67	IP67
Connection method	Individual wires	Individual wires	Individual wires
Electrical data			
Rated voltage	250 V	60 V	30 V
Rated current	4 A	4 A	2 A
Material data			
Material contact/contact surface	CuZn / Ni/Au	CuZn / Ni/Au	CuZn / Ni/Au
Contact carrier material	PA66	PA66	PA66
Flammability rating in accordance with UL 94	V0	V0	V0
Cable type	TPE litz wire	TPE litz wire	TPE litz wire
Temperature data			
Male connector/female connector	-25 ... 85	-25 ... 85	-25 ... 85

Description	Coding	Ordering data					
		Order No.	Pcs./Pkt.	Order No.	Pcs./Pkt.	Order No.	Pcs./Pkt.
		4-pos.		5-pos.		8-pos.	
Device connector							
Female	A - standard	1693788	1	1671098	1	1513758	1
Male	A - standard	1693762	1	1671111	1	1513774	1
Female	B - inverse						
Male	B - inverse						

Accessories		
Flat nut, with: Pg9 thread	SACC-E-MU-PG9	1504084 100



	Technical data		
	4-pos.	5-pos.	8-pos.
General data			
M12 circular connector in accordance with:	IEC 61076-2-101	IEC 61076-2-101	IEC 61076-2-101
Degree of pollution	3	3	3
Degree of protection	IP67	IP67	IP67
Connection method	Individual wires	Individual wires	Individual wires
Electrical data			
Rated voltage	250 V	60 V	30 V
Rated current	4 A	4 A	2 A
Material data			
Material contact/contact surface	CuZn / Ni/Au	CuZn / Ni/Au	CuZn / Ni/Au
Contact carrier material	PA66	PA66	PA66
Flammability rating in accordance with UL 94	V0	V0	V0
Cable type	TPE litz wire	TPE litz wire	TPE litz wire
Temperature data			
Male connector/female connector	-25 ... 85	-25 ... 85	-25 ... 85

Description	Coding	Ordering data					
		Order No.	Pcs./Pkt.	Order No.	Pcs./Pkt.	Order No.	Pcs./Pkt.
		4-pos.		5-pos.		8-pos.	
Device connector							
Female	A - standard	1693791	1	1671108	1	1513761	1
Male	A - standard	1693775	1	1671124	1	1513787	1
Female	B - inverse			1515044	1		
Male	B - inverse			1515057	1		

Accessories		
Flat nut, with: Pg9 thread		

M12 sensor/actuator device connectors, front mounting

M16 fastening thread, with 0.5 m long litz wires



4-, 5-, 8-pos.



12-, 17-pos.



	Technical data		
	4-pos.	5-pos.	8-pos.
General data			
M12 circular connector in accordance with:	IEC 61076-2-101	IEC 61076-2-101	IEC 61076-2-101
Degree of pollution	3	3	3
Degree of protection	IP65/IP67	IP65/IP67	IP65/IP67
Connection method	Individual wires	Individual wires	Individual wires
Electrical data			
Rated voltage	250 V	60 V	30 V
Rated current	4 A	4 A	2 A
Material data			
Material contact/contact surface	CuZn / Ni/Au	CuZn / Ni/Au	CuZn / Ni/Au
Contact carrier material	PA 6.6	PA 6.6	PA 6.6
Flammability rating in accordance with UL 94	V0	V0	V0
Cable type	TPE litz wire	TPE litz wire	TPE litz wire
Temperature data			
Male connector/female connector	-25 ... 85	-25 ... 85	-25 ... 85



	Technical data	
	12-pos.	17-pos.
General data		
M12 circular connector in accordance with:	IEC 61076-2-101	IEC 61076-2-101
Degree of pollution	3	3
Degree of protection	IP65/IP67	IP65/IP67
Connection method	Individual wires	Individual wires
Electrical data		
Rated voltage	30 V	30 V
Rated current	1.5 A	1.5 A
Material data		
Material contact/contact surface	CuZn / Ni/Au	CuZn / Ni/Au
Contact carrier material	PA 6.6	PA 6.6
Flammability rating in accordance with UL 94	V0	V0
Cable type	TPE litz wire	TPE litz wire
Temperature data		
Male connector/female connector	-25 ... 85	-25 ... 85

Description	Coding	Ordering data					
		4-pos.		5-pos.		8-pos.	
		Order No.	Pcs./Pkt.	Order No.	Pcs./Pkt.	Order No.	Pcs./Pkt.
Device connector							
Female	A - standard	1523434	1	1520039	1	1523476	1
Male	A - standard	1523450	1	1520055	1	1523492	1
Female	D - data	1535202	1				
Male	D - data	1551558	1				
Female	B - inverse			1520000	1		
Male	B - inverse			1520013	1		

Description	Coding	Ordering data			
		12-pos.		17-pos.	
		Order No.	Pcs./Pkt.	Order No.	Pcs./Pkt.
Female	A - standard	1556252	1	1556294	1
Male	A - standard	1556265	1	1556304	1

Accessories		
Flat nut, with: M16 thread	SACC-E-MU-M16	1504097 100

Accessories		
Flat nut, with: M16 thread	SACC-E-MU-M16	1504097 100

Circular connectors

M12 sensor/actuator device connectors, front mounting

M16 fastening thread, with 0.5 m long litz wires, can be positioned



can be positioned, 4-, 5-pos.



can be positioned, 8-pos.



Technical data

Technical data

General data	
M12 circular connector in accordance with:	
Degree of pollution	
Degree of protection	
Connection method	
Electrical data	
Rated voltage	
Rated current	
Material data	
Material contact/contact surface	
Contact carrier material	
Flammability rating in accordance with UL 94	
Cable type	
Temperature data	
Male connector/female connector	[°C]

	4-pos.	5-pos.
M12 circular connector in accordance with:	IEC 61076-2-101	IEC 61076-2-101
Degree of pollution	3	3
Degree of protection	IP67	IP67
Connection method	Individual wires	Individual wires
Rated voltage	250 V	60 V
Rated current	4 A	4 A
Material contact/contact surface	CuZn / Ni/Au	CuZn / Ni/Au
Contact carrier material	PA 6.6	PA 6.6
Flammability rating in accordance with UL 94	V0	V0
Cable type	TPE litz wire	TPE litz wire
Temperature data		
Male connector/female connector	-25 ... 85	-25 ... 85

	8-pos.
M12 circular connector in accordance with:	IEC 61076-2-101
Degree of pollution	3
Degree of protection	IP67
Connection method	Individual wires
Rated voltage	30 V
Rated current	2 A
Material contact/contact surface	CuZn / Ni/Au
Contact carrier material	PA 6.6
Flammability rating in accordance with UL 94	V0
Cable type	TPE litz wire
Temperature data	
Male connector/female connector	-25 ... 85

Ordering data

Ordering data

Description	Coding
Device connector	
Female	A - standard
Male	A - standard
Female	D - data
Male	D - data
Female	B - inverse
Male	B - inverse

Order No.	Pcs./Pkt.	Order No.	Pcs./Pkt.
4-pos.		5-pos.	
1523447	1	1520042	1
1523463	1	1520068	1
1535215	1		
1552256	1		
		1519998	1
		1520026	1

Order No.	Pcs./Pkt.	Order No.	Pcs./Pkt.
8-pos.			
1523489	1		
1523502	1		

**XL device connectors,
M16 fastening thread,
with 0.5 m long litz wires**

- Tightening limitation
- Wrench size 19



4-, 5-, 8-pos.



12-, 17-pos.



	Technical data		
	4-pos.	5-pos.	8-pos.
General data			
M12 circular connector in accordance with:	IEC 61076-2-101	IEC 61076-2-101	IEC 61076-2-101
Degree of pollution	3	3	3
Degree of protection	IP65/IP67	IP65/IP67	IP65/IP67
Connection method	Individual wires	Individual wires	Individual wires
Electrical data			
Rated voltage	250 V	60 V	30 V
Rated current	4 A	4 A	2 A
Material data			
Material contact/contact surface	CuZn / Au	CuZn / Au	CuZn / Au
Contact carrier material	PA 6.6	PA 6.6	PA 6.6
Flammability rating in accordance with UL 94	V0	V0	V0
Cable type	TPE litz wire	TPE litz wire	TPE litz wire
Temperature data			
Male connector/female connector	-25 ... 85	-25 ... 85	-25 ... 85



	Technical data	
	12-pos.	17-pos.
General data		
M12 circular connector in accordance with:	IEC 61076-2-101	IEC 61076-2-101
Degree of pollution	3	3
Degree of protection	IP65/IP67	IP65/IP67
Connection method	Individual wires	Individual wires
Electrical data		
Rated voltage	30 V	30 V
Rated current	1.5 A	1.5 A
Material data		
Material contact/contact surface	CuZn / Au	CuZn / Au
Contact carrier material	PA 6.6	PA 6.6
Flammability rating in accordance with UL 94	V0	V0
Cable type	TPE litz wire	TPE litz wire
Temperature data		
Male connector/female connector	-25 ... 85	-25 ... 85

Description	Coding	Ordering data					
		4-pos.		5-pos.		8-pos.	
		Order No.	Pcs./Pkt.	Order No.	Pcs./Pkt.	Order No.	Pcs./Pkt.
Device connector							
Female	A - standard	1411568	1	1411571	1	1411573	1
Male	A - standard	1411577	1	1411579	1	1411581	1
Female	D - data	1411569	1				
Male	D - data	1411578	1				
Female	B - inverse			1411572	1		
Male	B - inverse			1411580	1		

Description	Coding	Ordering data			
		12-pos.		17-pos.	
		Order No.	Pcs./Pkt.	Order No.	Pcs./Pkt.
Device connector					
Female	A - standard	1411574	1	1411576	1
Male	A - standard	1411582	1	1411583	1

Accessories		
Flat nut, with: M16 thread	SACC-E-MU-M16	1504097 100

Accessories		
Flat nut, with: M16 thread	SACC-E-MU-M16	1504097 100

Circular connectors

M12 sensor/actuator device connectors, front mounting

M20 fastening thread, with 0.5 m long litz wires

– Housing material: brass, nickel-plated



4-, 5-, 8-pos.



Technical data

	4-pos.	5-pos.	8-pos.
General data			
M12 circular connector in accordance with:	IEC 61076-2-101	IEC 61076-2-101	IEC 61076-2-101
Degree of pollution	3	3	3
Degree of protection	IP67/IP69K	IP67/IP69K	IP67/IP69K
Connection method	Individual wires	Individual wires	Individual wires
Electrical data			
Rated voltage	250 V	60 V	30 V
Rated current	4 A	4 A	2 A
Material data			
Material contact/contact surface	CuZn / Au	CuZn / Au	CuZn / Au
Contact carrier material	PA 6.6	PA 6.6	PA 6.6
Flammability rating in accordance with UL 94	V0	V0	V0
Cable type	TPE litz wire	TPE litz wire	TPE litz wire
Temperature data			
Male connector/female connector [°C]	-25 ... 85	-25 ... 85	-25 ... 85

Ordering data

Description	Coding	4-pos.		5-pos.		8-pos.	
		Order No.	Pcs./Pkt.	Order No.	Pcs./Pkt.	Order No.	Pcs./Pkt.
Device connector							
Female	A - standard	1408436	1	1408454	1	1408453	1
Male	A - standard	1408451	1	1408446	1	1408442	1

Circular connectors

M12 sensor/actuator device connectors, front mounting

One-piece, 20 mm square flange, with 0.5 m long litz wires

- 4x fixing hole, 3.2 mm
- With form seal for M3 screws



4-, 5-, 8-pos.



12-, 17-pos.



	Technical data										
	4-pos.		5-pos.		8-pos.						
General data	M12 circular connector in accordance with:										
Degree of pollution	3		3		3						
Degree of protection	IP67		IP67		IP67						
Connection method	Individual wires		Individual wires		Individual wires						
Electrical data	250 V		60 V		30 V						
Rated voltage	4 A		4 A		2 A						
Rated current	CuZn / Ni/Au		CuZn / Ni/Au		CuZn / Ni/Au						
Material contact/contact surface	PA 6.6		PA 6.6		PA 6.6						
Contact carrier material	V0		V0		V0						
Flammability rating in accordance with UL 94	TPE litz wire		TPE litz wire		TPE litz wire						
Cable type	-25 ... 85		-25 ... 85		-25 ... 85						
Temperature data	[°C]		[°C]		[°C]						
Male connector/female connector	-25 ... 85		-25 ... 85		-25 ... 85						
	Technical data										
	12-pos.		17-pos.								
General data	M12 circular connector in accordance with:										
Degree of pollution	3		3		3						
Degree of protection	IP67		IP67		IP67						
Connection method	Individual wires		Individual wires		Individual wires						
Electrical data	30 V		30 V		30 V						
Rated voltage	1.5 A		1.5 A		1.5 A						
Rated current	CuZn / Ni/Au		CuZn / Ni/Au		CuZn / Ni/Au						
Material contact/contact surface	PA 6.6		PA 6.6		PA 6.6						
Contact carrier material	V0		V0		V0						
Flammability rating in accordance with UL 94	TPE litz wire		TPE litz wire		TPE litz wire						
Cable type	-25 ... 85		-25 ... 85		-25 ... 85						
Temperature data	[°C]		[°C]		[°C]						
Male connector/female connector	-25 ... 85		-25 ... 85		-25 ... 85						
	Ordering data										
Description	Coding	Order No.	Pcs./Pkt.	Order No.	Pcs./Pkt.	Order No.	Pcs./Pkt.	Order No.	Pcs./Pkt.	Order No.	Pcs./Pkt.
		4-pos.		5-pos.		8-pos.		12-pos.		17-pos.	
Device connector											
Female	A - standard	1419797	1	1441655	1	1441697	1	1441710	1	1441736	1
Male	A - standard	1419784	1	1441642	1	1441684	1	1441707	1	1441723	1
Female	D - data	1441639	1								
Male	D - data	1441626	1								
Female	B - inverse			1441671	1						
Male	B - inverse			1441668	1						

M12 sensor/actuator device connectors, front mounting

One-piece, 25 mm square flange, with 0.5 m long litz wires

- 4 x fixing hole, 2.7 mm
- With form seal for M2.5 screws



4-, 5-, 8-pos.



12-, 17-pos.



	Technical data		
	4-pos.	5-pos.	8-pos.
General data			
M12 circular connector in accordance with:	IEC 61076-2-101	IEC 61076-2-101	IEC 61076-2-101
Degree of pollution	3	3	3
Degree of protection	IP67	IP67	IP67
Connection method	Individual wires	Individual wires	Individual wires
Electrical data			
Rated voltage	250 V	60 V	30 V
Rated current	4 A	4 A	2 A
Material data			
Material contact/contact surface	CuZn / Ni/Au	CuZn / Ni/Au	CuZn / Ni/Au
Contact carrier material	PA 6.6	PA 6.6	PA 6.6
Flammability rating in accordance with UL 94	V0	V0	V0
Cable type	TPE litz wire	TPE litz wire	TPE litz wire
Temperature data			
Male connector/female connector	-25 ... 85	-25 ... 85	-25 ... 85

	Technical data	
	12-pos.	17-pos.
General data		
M12 circular connector in accordance with:	IEC 61076-2-101	IEC 61076-2-101
Degree of pollution	3	3
Degree of protection	IP67	IP67
Connection method	Individual wires	Individual wires
Electrical data		
Rated voltage	30 V	30 V
Rated current	1.5 A	1.5 A
Material data		
Material contact/contact surface	CuZn / Ni/Au	CuZn / Ni/Au
Contact carrier material	PA 6.6	PA 6.6
Flammability rating in accordance with UL 94	V0	V0
Cable type	TPE litz wire	TPE litz wire
Temperature data		
Male connector/female connector	-25 ... 85	-25 ... 85

Description	Coding	Ordering data					
		4-pos.		5-pos.		8-pos.	
		Order No.	Pcs./Pkt.	Order No.	Pcs./Pkt.	Order No.	Pcs./Pkt.
Device connector							
Female	A - standard	1420003	1	1440986	1	1441574	1
Male	A - standard	1419991	1	1440973	1	1441561	1
Female	D - data	1440960	1				
Male	D - data	1440957	1				
Female	B - inverse			1441558	1		
Male	B - inverse			1440999	1		

Description	Coding	Ordering data			
		12-pos.		17-pos.	
		Order No.	Pcs./Pkt.	Order No.	Pcs./Pkt.
Female	A - standard	1441590	1	1441613	1
Male	A - standard	1441587	1	1441600	1

Circular connectors

M12 sensor/actuator device connectors, front mounting

Modular, 25 mm square flange, pre-assembled



Flange housing, housing bore holes 3.2 mm



With 0.5 m long litz wires, assembled contact carrier and insulating body

ERC

Technical data

General data			
M12 circular connector in accordance with:	IEC 61076-2-101		
Degree of pollution	-		
Degree of protection	-		
Connection method	-		
Electrical data			
Rated voltage			
Rated current	-		
Material data			
Material contact/contact surface	- / -		
Contact carrier material	-		
Cable gland material	Zinc die-cast, nickel-plated		
Flammability rating in accordance with UL 94	-		
Cable type	-		
Temperature data			
Male connector/female connector	[°C]	-40 ... 85	

Ordering data

Description	Coding	Order No.	Pcs./Pkt.	Order No.	Pcs./Pkt.	Order No.	Pcs./Pkt.
Square flange housing, with O-ring		1419959	10				
Assembled contact carrier and insulating body, with 0.5 m litz wires and crimp contacts							
Male	A - standard						
Male	D - data						
Male	B - inverse						

ERC

Technical data

4-pos.	5-pos.	8-pos.
IEC 61076-2-101	IEC 61076-2-101	IEC 61076-2-101
3	3	3
IP67	IP67	IP67
Crimp contacts	Crimp contacts	Crimp contacts
250 V	60 V	30 V
4 A	4 A	2 A
CuZn / Au	CuZn / Au	CuZn / Au
PA 6.6	PA 6.6	PA 6.6
-	-	-
V0	V0	V0
TPE litz wire	TPE litz wire	TPE litz wire
-25 ... 85	-25 ... 85	-25 ... 85

Ordering data

4-pos.		5-pos.		8-pos.	
Order No.	Pcs./Pkt.	Order No.	Pcs./Pkt.	Order No.	Pcs./Pkt.
1440805	1	1440818	1	1457827	1
1440821	1	1440759	1		

Modular, 25 mm square flange, for free assembly



Flange housing, housing bore holes 3.2 mm



Contact carriers and insulating bodies for assembly

ERC

Technical data

General data			
M12 circular connector in accordance with:	IEC 61076-2-101		
Degree of pollution	-		
Degree of protection	-		
Connection method	-		
Electrical data			
Rated voltage	-		
Rated current	-		
Material data			
Contact carrier material	-		
Cable gland material	Zinc die-cast, nickel-plated		
Flammability rating in accordance with UL 94	-		
Temperature data			
Male connector/female connector	[°C]	-40 ... 85	

Ordering data

Description	Coding	Order No.	Pcs./Pkt.	Order No.	Pcs./Pkt.	Order No.	Pcs./Pkt.
Square flange housing, with O-ring		1419959	10				
Contact carrier and insulating bodies							
Male	A - standard						
Male	D - data						
Male	B - inverse						
Crimp contact, for 4- and 5-pos. contact carriers, contact material: CuZn, surface: gold-plated, connection cross section: 0.08 mm ² ... 0.34 mm ²							
Contact Ø: 1.0 mm							
Crimp contact, for 8-pos. contact carriers, contact material: CuZn, surface: gold-plated, connection cross section: 0.08 mm ² 0.34 mm ²							
Contact Ø: 0.8 mm							

Accessories

Crimping pliers, for turned contacts, universal cross section setting, up to a maximum of 2.5 mm ² , digital display with 0.01 mm increments, unlockable pressure lock, lateral entry, including positioning tool			
for turned contacts, four-mandrel crimping			

ERC

Technical data

4-pos.	5-pos.	8-pos.
IEC 61076-2-101	IEC 61076-2-101	IEC 61076-2-101
3	3	3
IP67	IP67	IP67
Crimp contacts	Crimp contacts	Crimp contacts
250 V	60 V	30 V
4 A	4 A	2 A
PA 6.6	PA 6.6	PA 6.6
-	-	-
V0	V0	V0
-25 ... 85	-25 ... 85	-25 ... 85

Ordering data

Order No.	Pcs./Pkt.	Order No.	Pcs./Pkt.	Order No.	Pcs./Pkt.
1440931	10	1419988	10	1440928	10
1440944	10	1440915	10		
1452356	100	1452356	100		
				1452372	100

Accessories

CRIMPFOX-TC MP		1212510	1
-----------------------	--	---------	---

Circular connectors

M12 sensor/actuator device connectors, rear mounting

Pg9 fastening thread,
with 0.5 m long litz wires



4-, 5-, 8-pos.



12-, 17-pos.



Technical data

Technical data

	4-pos.			5-pos.			8-pos.			12-pos.		17-pos.	
	IEC 61076-2-101			IEC 61076-2-101			IEC 61076-2-101			IEC 61076-2-101		IEC 61076-2-101	
General data													
M12 circular connector in accordance with:	3			3			3			3		3	
Degree of pollution	IP67			IP67			IP67			IP67		IP67	
Degree of protection	Individual wires			Individual wires			Individual wires			Individual wires		Individual wires	
Connection method													
Electrical data													
Rated voltage	250 V			60 V			30 V			30 V		30 V	
Rated current	4 A			4 A			2 A			1.5 A		1.5 A	
Material data													
Material contact/contact surface	CuZn / Au			CuZn / Au			CuZn / Au			CuZn / Au		CuZn / Au	
Contact carrier material	PA 6.6			PA 6.6			PA 6.6			PA 6.6		PA 6.6	
Flammability rating in accordance with UL 94	V0			V0			V0			V0		V0	
Cable type	TPE litz wire			TPE litz wire			TPE litz wire			TPE litz wire		TPE litz wire	
Temperature data													
Male connector/female connector	-25 ... 85			-25 ... 85			-25 ... 85			-25 ... 85		-25 ... 85	

Ordering data

Ordering data

Description	Coding	4-pos.			5-pos.			8-pos.			12-pos.		17-pos.	
		Order No.	Pcs./Pkt.		Order No.	Pcs./Pkt.		Order No.	Pcs./Pkt.		Order No.	Pcs./Pkt.	Order No.	Pcs./Pkt.
Device connector														
Female	A - standard	1556621	1	1542729	1	1542732	1	1430446	1	1430462	1			
Male	A - standard	1556618	1	1542703	1	1542716	1	1430459	1	1430475	1			
Female	D - data	1551529	1											
Male	D - data	1551532	1											
Female	B - inverse			1543676	1									
Male	B - inverse			1543663	1									

M12 sensor/actuator device connectors, rear mounting

M12 fastening thread, with 0.5 m long litz wires



4-, 5-, 8-pos.



12-, 17-pos.



	Technical data		
	4-pos.	5-pos.	8-pos.
General data			
M12 circular connector in accordance with:	IEC 61076-2-101	IEC 61076-2-101	IEC 61076-2-101
Degree of pollution	3	3	3
Degree of protection	IP67	IP67	IP67
Connection method	Individual wires	Individual wires	Individual wires
Electrical data			
Rated voltage	250 V	60 V	30 V
Rated current	4 A	4 A	2 A
Material data			
Material contact/contact surface	CuZn / Au	CuZn / Au	CuZn / Au
Contact carrier material	PA 6.6	PA 6.6	PA 6.6
Flammability rating in accordance with UL 94	V0	V0	V0
Cable type	TPE litz wire	TPE litz wire	TPE litz wire
Temperature data			
Male connector/female connector	-25 ... 85	-25 ... 85	-25 ... 85

	Technical data	
	12-pos.	17-pos.
General data		
M12 circular connector in accordance with:	IEC 61076-2-101	IEC 61076-2-101
Degree of pollution	3	3
Degree of protection	IP67	IP67
Connection method	Individual wires	Individual wires
Electrical data		
Rated voltage	30 V	30 V
Rated current	1.5 A	1.5 A
Material data		
Material contact/contact surface	CuZn / Au	CuZn / Au
Contact carrier material	PA 6.6	PA 6.6
Flammability rating in accordance with UL 94	V0	V0
Cable type	TPE litz wire	TPE litz wire
Temperature data		
Male connector/female connector	-25 ... 85	-25 ... 85

Description	Coding	Ordering data					
		4-pos.		5-pos.		8-pos.	
		Order No.	Pcs./Pkt.	Order No.	Pcs./Pkt.	Order No.	Pcs./Pkt.
Device connector							
Male	A - standard	1551875	1	1551888	1	1551914	1
Male	D - data	1551901	1				
Male	B - inverse			1551891	1		

Description	Coding	Ordering data			
		12-pos.		17-pos.	
		Order No.	Pcs./Pkt.	Order No.	Pcs./Pkt.
Device connector					
Male		1437122	1	1437135	1

Circular connectors

M12 sensor/actuator device connectors, rear mounting

M12 push-pull locking, with 0.5 m litz wires

- Manufacturer-independent M12 push-pull locking system



Technical data

4-pos.

General data
M12 circular connector in accordance with:
Degree of pollution
Degree of protection
Connection method
Electrical data
Rated voltage
Rated current
Material data
Material contact/contact surface
Contact carrier material
Flammability rating in accordance with UL 94
Cable type
Temperature data
Male connector/female connector [°C]

IEC 61076-2-101
3
IP67
Individual wires

250 V
4 A

CuZn / Au
PA 6.6
V0
TPE litz wire

-25 ... 85

Ordering data

Description	Coding
Device connector	
Female	A-coded
Female	D-coded

Order No.	Pcs./Pkt.
	4-pos.

1027670	1
---------	---



Technical data

5-pos.

General data
M12 circular connector in accordance with:
Degree of pollution
Degree of protection
Connection method
Electrical data
Rated voltage
Rated current
Material data
Material contact/contact surface
Contact carrier material
Flammability rating in accordance with UL 94
Cable type
Temperature data
Male connector/female connector [°C]

IEC 61076-2-101
3
IP67
Individual wires

60 V
4 A

CuZn / Au
PA 6.6
V0
TPE litz wire

-25 ... 85

Ordering data

Description	Coding
Device connector	
Female	A-coded
Female	D-coded

Order No.	Pcs./Pkt.
	5-pos.

1027666	1
---------	---

M12 sensor/actuator device connectors, rear mounting

M16 fastening thread,
with 0.5 m long litz wires



4-, 5-, 8-pos.



12-, 17-pos.



	Technical data		
	4-pos.	5-pos.	8-pos.
General data			
M12 circular connector in accordance with:	IEC 61076-2-101	IEC 61076-2-101	IEC 61076-2-101
Degree of pollution	3	3	3
Degree of protection	IP65/IP67	IP65/IP67	IP65/IP67
Connection method	Individual wires	Individual wires	Individual wires
Electrical data			
Rated voltage	250 V	60 V	30 V
Rated current	4 A	4 A	2 A
Material data			
Material contact/contact surface	CuZn / Au	CuZn / Au	CuZn / Au
Contact carrier material	PA 6.6	PA 6.6	PA 6.6
Flammability rating in accordance with UL 94	V0	V0	V0
Cable type	TPE litz wire	TPE litz wire	TPE litz wire
Temperature data			
Male connector/female connector	-25 ... 85	-25 ... 85	-25 ... 85



	Technical data	
	12-pos.	17-pos.
General data		
M12 circular connector in accordance with:	IEC 61076-2-101	IEC 61076-2-101
Degree of pollution	3	3
Degree of protection	IP65/IP67	IP65/IP67
Connection method	Individual wires	Individual wires
Electrical data		
Rated voltage	30 V	30 V
Rated current	1.5 A	1.5 A
Material data		
Material contact/contact surface	CuZn / Au	CuZn / Au
Contact carrier material	PA 6.6	PA 6.6
Flammability rating in accordance with UL 94	V0	V0
Cable type	TPE litz wire	TPE litz wire
Temperature data		
Male connector/female connector	-25 ... 85	-25 ... 85

Description	Coding	Ordering data					
		4-pos.		5-pos.		8-pos.	
		Order No.	Pcs./Pkt.	Order No.	Pcs./Pkt.	Order No.	Pcs./Pkt.
Device connector							
Female	A - standard	1419632	1	1419658	1	1419690	1
Male	A - standard	1419629	1	1419645	1	1419687	1
Female	D - data	1419616	1				
Male	D - data	1419603	1				
Female	B - inverse			1419674	1		
Male	B - inverse			1419661	1		

Description	Coding	Ordering data			
		12-pos.		17-pos.	
		Order No.	Pcs./Pkt.	Order No.	Pcs./Pkt.
Female	A - standard	1419713	1	1419739	1
Male	A - standard	1419700	1	1419726	1

Circular connectors

M12 sensor/actuator device connectors, rear mounting

XL device connectors, M16 fastening thread, with 0.5 m long litz wires

- Tightening limitation
- Wrench size 19



4-, 5-, 8-pos.



12-, 17-pos.



	Technical data		
	4-pos.	5-pos.	8-pos.
General data			
M12 circular connector in accordance with:	IEC 61076-2-101	IEC 61076-2-101	IEC 61076-2-101
Degree of pollution	3	3	3
Degree of protection	IP65/IP67	IP65/IP67	IP65/IP67
Connection method	Individual wires	Individual wires	Individual wires
Electrical data			
Rated voltage	250 V	60 V	30 V
Rated current	4 A	4 A	2 A
Material data			
Material contact/contact surface	CuZn / Au	CuZn / Au	CuZn / Au
Contact carrier material	PA 6.6	PA 6.6	PA 6.6
Flammability rating in accordance with UL 94	V0	V0	V0
Cable type	TPE litz wire	TPE litz wire	TPE litz wire
Temperature data			
Male connector/female connector [°C]	-25 ... 85	-25 ... 85	-25 ... 85



	Technical data	
	12-pos.	17-pos.
General data		
M12 circular connector in accordance with:	IEC 61076-2-101	IEC 61076-2-101
Degree of pollution	3	3
Degree of protection	IP65/IP67	IP65/IP67
Connection method	Individual wires	Individual wires
Electrical data		
Rated voltage	30 V	30 V
Rated current	1.5 A	1.5 A
Material data		
Material contact/contact surface	CuZn / Au	CuZn / Au
Contact carrier material	PA 6.6	PA 6.6
Flammability rating in accordance with UL 94	V0	V0
Cable type	TPE litz wire	TPE litz wire
Temperature data		
Male connector/female connector [°C]	-25 ... 85	-25 ... 85

Description	Coding	Ordering data					
		4-pos.		5-pos.		8-pos.	
		Order No.	Pcs./Pkt.	Order No.	Pcs./Pkt.	Order No.	Pcs./Pkt.
Device connector							
Female	A - standard	1411584	1	1411586	1	1411588	1
Male	A - standard	1411591	1	1411593	1	1411595	1
Female	D - data	1411585	1				
Male	D - data	1411592	1				
Female	B - inverse			1411587	1		
Male	B - inverse			1411594	1		

Description	Coding	Ordering data			
		12-pos.		17-pos.	
		Order No.	Pcs./Pkt.	Order No.	Pcs./Pkt.
Device connector					
Female	A - standard	1411589	1	1411590	1
Male	A - standard	1411596	1	1411597	1

M12 sensor/actuator device connectors, rear mounting

M16 fastening thread,
with assembled cable, shielded



PUR cable, 4-, 5-, 8-pos.,
shielded



PVC cable, 12-, 17-pos.,
shielded

ERIC

	Technical data		
	4-pos.	5-pos.	8-pos.
General data			
M12 circular connector in accordance with:	IEC 61076-2-101	IEC 61076-2-101	IEC 61076-2-101
Degree of pollution	3	3	3
Degree of protection	IP67	IP67	IP67
Connection method	Individual wires	Individual wires	Individual wires
Electrical data			
Rated voltage	250 V	60 V	30 V
Rated current	4 A	4 A	2 A
Material data			
Material contact/contact surface	CuZn / Au	CuZn / Au	CuZn / Au
Contact carrier material	PA 6.6	PA 6.6	PA 6.6
Flammability rating in accordance with UL 94	V0	V0	V0
Cable type	PUR halogen-free black	PUR halogen-free black	PUR halogen-free black
Temperature data			
Male connector/female connector	-25 ... 85	-25 ... 85	-25 ... 85

ERIC

	Technical data	
	12-pos.	17-pos.
General data		
M12 circular connector in accordance with:	IEC 61076-2-101	IEC 61076-2-101
Degree of pollution	3	3
Degree of protection	IP67	IP67
Connection method	Individual wires	Individual wires
Electrical data		
Rated voltage	30 V	30 V
Rated current	1.5 A	1.5 A
Material data		
Material contact/contact surface	CuZn / Au	CuZn / Au
Contact carrier material	PA 6.6	PA 6.6
Flammability rating in accordance with UL 94	V0	V0
Cable type	PVC black	PVC black
Temperature data		
Male connector/female connector	-25 ... 85	-25 ... 85

Description	Cable length	Ordering data					
		4-pos.		5-pos.		8-pos.	
		Order No.	Pcs./Pkt.	Order No.	Pcs./Pkt.	Order No.	Pcs./Pkt.
Device connector, A-coded							
Female	1 m	1419302	1	1419328	1	1419357	1
Male	1 m	1419399	1	1419409	1	1419425	1
Female	2 m	1419315	1	1419331	1	1419344	1
Male	2 m	1419386	1	1419412	1	1419438	1

Description	Cable length	Ordering data			
		12-pos.		17-pos.	
		Order No.	Pcs./Pkt.	Order No.	Pcs./Pkt.
Female	1 m	1442188	1	1442269	1
Male	1 m	1442227	1	1442308	1
Female	2 m	1442191	1	1442272	1
Male	2 m	1442230	1	1442311	1

Circular connectors

M12 sensor/actuator device connectors, rear mounting

Pg9 fastening thread, plastic, with 0.5 m long litz wires



5-, 8-pos.

ERC

Technical data

	5-pos.	8-pos.
General data		
M12 circular connector in accordance with:	IEC 61076-2-101	IEC 61076-2-101
Degree of pollution	3	3
Degree of protection	IP67	IP67
Electrical data		
Rated voltage	60 V	30 V
Rated current	4 A	2 A
Material data		
Material contact/contact surface	CuZn / Au	CuZn / Au
Contact carrier material	PA 6.6	PA 6.6
Flammability rating in accordance with UL 94	HB	HB
Temperature data		
Male connector/female connector	-25 ... 85	-25 ... 85

Ordering data

Description	Coding	Order No.	Pcs./Pkt.	Order No.	Pcs./Pkt.
		5-pos.		8-pos.	
Device connector					
Female	A - standard	1436356	1	1436369	1

M16 fastening thread, control cabinet feed-through



4-, 5-, 8-pos.

EAC

	Technical data						
	4-pos.	5-pos.	8-pos.				
General data							
M12 circular connector in accordance with:	IEC 61076-2-101	IEC 61076-2-101	IEC 61076-2-101				
Degree of pollution	3	3	3				
Degree of protection	IP67	IP67	IP67				
Electrical data							
Rated voltage	60 V	60 V	30 V				
Rated current	4 A	4 A	2 A				
Material data							
Contact material	CuZn	CuZn	CuZn				
Contact surface material	Au	Au	Au				
Contact carrier material	PA 6.6	PA 6.6	PA 6.6				
Flammability rating in accordance with UL 94	HB	HB	HB				
Temperature data							
Male connector/female connector	[°C]	-25 ... 85	-25 ... 85				
		Ordering data					
Description	Coding	Order No.	Pcs./Pkt.	Order No.	Pcs./Pkt.	Order No.	Pcs./Pkt.
		4-pos.		5-pos.		8-pos.	
Control cabinet feed-through, M16 fastening thread							
Male to female	A - standard			1551671	1	1551697	1
Male to female	B - inverse			1551684	1		
Female to female	D - data	1424326	1				

Sealing elements

During transport or when in the field, unused plug-in connections must be protected or sealed. Plastic or metal screw plugs, sealing caps, and sealing plugs can be used for this. IP65/IP67 and IP69K protection is achieved.



Description	Ordering data		
	Type	Order No.	Pcs./Pkt.
M5 screw plug for unused M5 sockets of sensor/actuator cables, boxes, and device connectors ①	PROT-M5	1533288	10
M8 screw plug for unused M8 sockets of sensor/actuator cables, boxes, and device connectors ②	PROT-M8	1682540	5
M12 screw plug for unused M12 sockets of sensor/actuator cables, boxes, and device connectors ③	PROT-M12	1680539	5
M12 screw plug fast locking system for unused M12 sockets of sensor/actuator cables, boxes, and device connectors ④	PROT-MS SCO	1553129	5
M12 sealing cap for unused M12 connectors of sensor/actuator cables, device connectors, and I/O devices in the field ⑤	PROT-M12 FS	1560251	5
M12 screw plug, metal for unused M12 sockets of shielded sensor/actuator cables, boxes, and device connectors ⑥	PROT-M12 SH	1503302	5
Metal M12 sealing cap for unused M12 connectors of sensor/actuator cables, device connectors, and I/O devices in the field ⑦	PROT-M12 FS-M	1430488	10
for unused M12 sockets	PROT-M12 MS-M	1414148	10
Stainless steel M12 screw plug for unused M12 sockets of sensor/actuator cables, boxes, and device connectors ⑧	PROT-M12 FB	1555538	5
Closing cap for Pg9/ Pg11, to close unoccupied connections ⑨	Q-PROT 9/11	1670235	10
M16 screw plug With flat nut for oval housing cutouts ⑩	SACC-M16-SEALING PLUG SET	1453368	10

Sealing elements with holding band or fixing chain

All IP67 interfaces can be closed tightly using the screw plugs and sealing caps in the sizes M8, M12 and 7/8". The holding bands are fastened on the cable or the housing and are thus held captive.

The M12 metal protective cap with fixing chain is suitable for all male versions. It is used in harsh industrial environments or for EMC applications.



		Ordering data		
Description	Type	Order No.	Pcs./Pkt.	
Screw plug made from plastic with retaining strap, for sealing unused sockets ① M8 for SAC cables M8 with 3 mm fastening eye M8 with 12 mm fastening eye M12 for SAC cables M12 with 15 mm fastening eye 7/8" for SAC cables	PROT-M 8 MS-PA-CHAIN PROT-M 8 MS-PA-CHAIN-EYE-DM3 PROT-M 8 MS-PA-CHAIN-EYE PROT-M12 MS-PA-CHAIN PROT-M12 MS-PA-CHAIN-EYE-DM14 PROT-MINMS-PA-CHAIN	1430860 1441105 1441095 1430899 1456200 1430925	10 10 10 5 5 10	
Plastic sealing cap with holding band, for closing unoccupied connectors ② M8 for SAC cables M8 with 8 mm fastening eye M12 for SAC cables M12 with 12 mm fastening eye M12 with 15 mm fastening eye 7/8" for SAC cables	PROT-M 8 FS-PA-CHAIN PROT-M 8 FS-PA-CHAIN-EYE PROT-M12 FS-PA-CHAIN PROT-M12 FS-PA-CHAIN-EYE-DM12 PROT-M12 FS-PA-CHAIN-EYE-DM14 PROT-MINFS-PA-CHAIN	1430857 1441082 1430873 1456187 1456190 1430912	10 10 5 5 5 10	
Sealing cap made of metal with fixing chain and 16 mm fastening eye, for sealing: ③ unused M12 male connectors unused M12 female connectors	PROT-M12 FS-M-CHAIN PROT-M12 MS-M-CHAIN	1430491 1414147	10 1	

Accessories for device connectors

Special fixing nuts are available for the EMC-compliant installation of M12 device connectors for coated or painted housing surfaces. When tightened they cut through the surface coating and establish contact between the housing and the connector.

Alternatively, flat gaskets can be used to provide the seal between the housing panel and device connector. This means that the housing cutouts no longer need to be chamfered for thin panels.



Description	Ordering data		
	Type	Order No.	Pcs./Pkt.
EMC hexagonal nut with fine tooting, for all device connectors with: M12 fastening thread ①	SACC-M12-KD-NUT-SH	1440151	10
EMC hexagonal nut with fine tooting, for all device connectors with: M16 fastening thread ②	SACC-M16-KD-NUT-SH	1440164	10
Pg9 fastening thread ③	SACC-PG9-KD-NUT-SH	1440177	10
Flat gasket for all device connectors with: M16 fastening thread ③	SACC-M16-SEAL CLM	1430394	10
Pg9 fastening thread ③	SACC-PG9-SEAL CLM	1556320	10

Assembly tools for sensor/actuator cables

To achieve tight plug-in connections, we recommend using assembly tools. M12 and 7/8" circular connectors can be assembled using a torque screwdriver and plug attachment.

The benefits of the plug attachment become particularly clear when connecting the connectors to distributor boxes. Thanks to the open design, it enables quick adjustment and installation even when space is at a premium.

The version for M12 connectors with hexagonal high-grade steel knurl is also made from high-grade steel. This prevents the connector knurls from being contaminated by corrosive materials.

For greater flexibility, screwdrivers with adjustable torque are available. When used in conjunction with the adapter insert, the available nuts can also be accommodated.

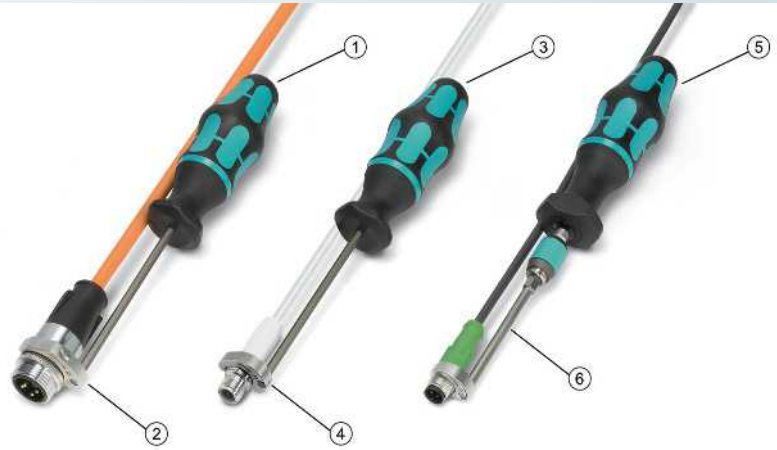

		Ordering data		
Description		Type	Order No.	Pcs./Pkt.
Torque screwdriver With a preset torque of 0.8 Nm and a 4 mm hexagonal drive	①	TSD 08 SAC	1212597	1
Nut for assembling 7/8" connectors, with a knurl diameter of 25 mm, with 4 mm hexagonal drive	②	SAC BIT MIN-D25	1212512	1
Torque screwdriver With preset torque of 0.4 Nm and 4 mm hexagonal drive	③	TSD 04 SAC	1208429	1
Nut for assembling sensor/actuator cables with M12 connector and M12 connectors for assembly, with a hexagonal knurl wrench size of 14 mm, with 4 mm hexagonal drive	④	SAC BIT M12-W14	1212513	1
Torque screwdriver , accuracy in accordance with standard EN ISO 6789 adjustable from 0.3 ... 1.2 Nm adjustable from 1.2 ... 3 Nm adjustable from 3 ... 6 Nm	⑤	TSD-M 1,2NM TSD-M 3NM TSD-M 6NM	1212224 1212225 1212226	1 1 1
Adapter insert For torque screwdrivers with adjustable torque, for accommodating plug attachments with 4 mm hexagonal drive	⑥	TSD-M SAC-BIT ADAPTER	1212600	1

Circular connectors

Pin assignments

M5 device connectors

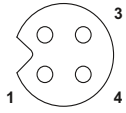

Female, 3-pos.

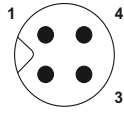

Male, 3-pos.

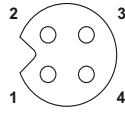

Female, 4-pos.

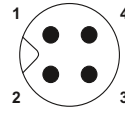

Male, 4-pos.

Pin	3-pos.		4-pos.	
1	BN		BN	
2	-		WH	
3	BU		BU	
4	BK		BK	

M8 device connectors

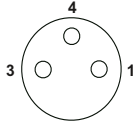

Female, 3-pos.

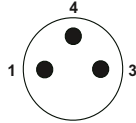

Male, 3-pos.

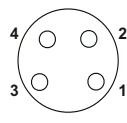

Female, 4-pos.

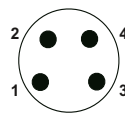

Male, 4-pos.

Pin	3-pos., A-coded		4-pos., A-coded	
1	BN		BN	
2	-		WH	
3	BU		BU	
4	BK		BK	

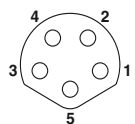

Female, 5-pos., B-coded

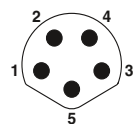

Male, 5-pos., B-coded

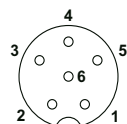

Female, 6-pos.

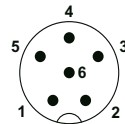

Male, 6-pos.

Pin	5-pos. B-coded		6-pos., A-coded	
1	GY		BN	
2	RD		WH	
3	WH		BU	
4	BK		BK	
5	BU		GY	
6	-		PK	

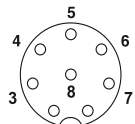

Female, 8-pos.

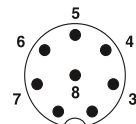

Male, 8-pos.

Pin	8-pos., A-coded	
1	WH	
2	BN	
3	GN	
4	YE	
5	GY	
6	PK	
7	BU	
8	RD	

M12 device connectors

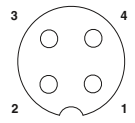

Female, 4-pos., A-coded

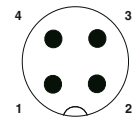

Male, 4-pos., A-coded

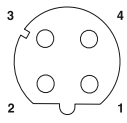

Female, 4-pos., D-coded

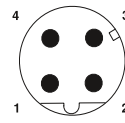

Male, 4-pos., D-coded

Pin	4-pos., A-coded		4-pos., D-coded	
1	BN		YE	
2	WH		WH	
3	BU		OG	
4	BK		BU	

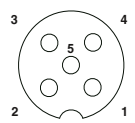

Female, 5-pos., A-coded

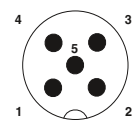

Male, 5-pos., A-coded

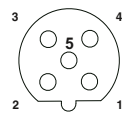

Female, 5-pos., B-coded

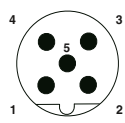

Male, 5-pos., B-coded

Pin	5-pos., A-coded		5-pos., B-coded	
1	BN		BN	
2	WH		WH	
3	BU		BU	
4	BK		BK	
5	GY		GY	

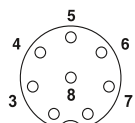

Female, 8-pos.

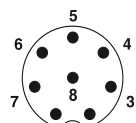

Male, 8-pos.

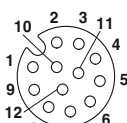

Female, 12-pos.

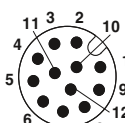

Male, 12-pos.

Pin	8-pos.		12-pos.	
1	WH		BN	
2	BN		BU	
3	GN		WH	
4	YE		GN	
5	GY		PK	
6	PK		YE	
7	BU		BK	
8	RD		GY	
9	-		RD	
10	-		VT	
11	-		GYPK	
12	-		RDBU	

M12 device connectors

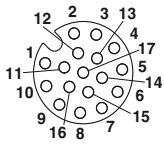

Female, 17-pos.

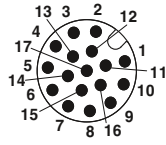

Male, 17-pos.

Pin	17-pos.	Pin	17-pos.
1	BN	9	RD
2	BU	10	VT
3	WH	11	GYPK
4	GN	12	RDBU
5	PK	13	WHGN
6	YE	14	BNGN
7	BK	15	WHYE
8	GY	16	YEEN
		17	WHGY

7/8" device connectors

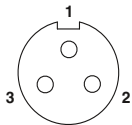

Female, 3-pos.

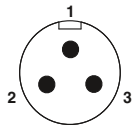

Male, 3-pos.

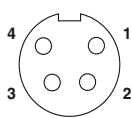

Female, 4-pos.

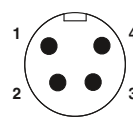

Male, 4-pos.

Pin	3-pos.	4-pos.
1	BK	BK
2	BN	BU
3	BU	BN
4	-	WH

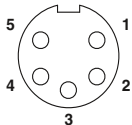

Female, 5-pos.

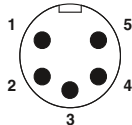

Male, 5-pos.

Pin	5-pos.
1	BK
2	BU
3	GNYE
4	BN
5	WH

Mechanical and electrical data

Mechanical data	
Housing material:	Copper zinc alloy (CuZn), die-cast zinc (GD-Zn)
Housing surface:	Nickel-plated / thick layer passivated (can be coated)
Insulating body:	Polyamide (PA 66)
Contact material:	Copper zinc alloy (CuZn)
Contact surface:	Nickel-plated (Ni) with gold coating (Au)
Connection technology:	Crimp connection
Sealing and O-ring:	Fluororubber (FPM)
Ambient temperature:	-40°C ... 125°C
Cable entry:	Cable and coupler connectors for an outer cable diameter of 3.5 to 11 mm, shielded (M17 Compact) 5 to 12.5 mm, shielded (M17)
Type of locking:	M17 SPEEDCON fast locking system, cable connector With M17 x 1 coarse-pitch thread as an option
Mechanical insertion cycles:	Standard: 100, punched-rolled C-HC crimp contacts: up to 500
Protection class:	IP67 when locked



Electrical data			
Number of positions		8	17
Contacts		8	17
Contact Ø	[mm]	1	0.6
Litz wire cross section, turned crimp contacts	[mm ²]	0.06 ... 1.0	0.06 ... 0.5
Litz wire cross section, C-HC punched-rolled crimp contacts	[mm ²]	0.06 ... 0.56	–
Nominal current per contact at 25°C ¹⁾	[A]	8.0	3.6
Specifications in accordance with DIN EN 61984:2009			
Rated voltage	[V AC/DC]	60	60
Test/surge voltage	[kV AC]	1.5	1.5
Overvoltage category		III	III
Pollution degree ²⁾		3	3
Installation altitude	[m]	Up to 3000	Up to 3000
Cable clamping area ³⁾	Max. Ø [mm]	12.5	12.5

¹⁾ Determine the effective current carrying capacity depending on the application, if necessary, using a derating curve.

²⁾ The values specified assume that the connector pair is correctly locked and is only disconnected for testing and maintenance purposes. If the connector is unlocked and exposed to ambient conditions, and if there is a danger of pollution, seal the connector using a protective cap ≥ IP54.

³⁾ The cable clamping areas specified on the following pages may vary depending on the cable material and structure. Selection and testing is the responsibility of the user.

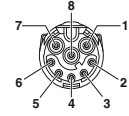
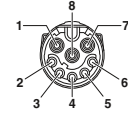
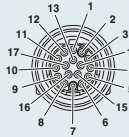
Contact chamber numbering
(view of plug-in side)

Number of positions	Male	Female
<p>8-pos. Crimp</p>		
<p>17-pos. Crimp</p>		

Note:

The connectors can be assembled with male or female contacts depending on the application.

For safety reasons, only use female contacts in the live part of the connector.

Circular connectors

M17 signal connectors

Selection guide

M17 signal connectors, 8- and 17-pos., crimp ranges: 0.06 mm² to 1.0 mm²

- Cable connectors
- Coupler connectors
- Device connectors (device flanges)

The connectors are delivered pre-assembled. The connectors can be furnished with the corresponding crimp contacts.

Every housing type can be assembled with male or female contacts. The connectors with knurled nuts can be equipped with the SPEEDCON fast locking system or with M17 x 1 coarse-pitch thread as an option. The connectors with external thread are fully compatible with standard threads and the SPEEDCON fast locking system.

The product chart provides an overview of the available components.

Connector type

Cable connectors

SPEEDCON fast locking system, M17 Compact, see page 64.



M17, see page 66.



M17 x 1 standard locking, M17, see page 66.

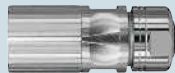

Square mounting flange for M17 cable and coupler connectors for wall mounting, see page 179.



Shielded

Coupler connectors / panel feed-throughs

Coupler connector M17 Compact, see page 64.



M17, see page 67.



Panel feed-through M17 Compact, see page 65.



Shielded

Device connectors

Straight, M17 Compact, see page 65.



Straight, M17, see page 67.



Straight, with central fastening thread, front mounting, M17, see page 69.

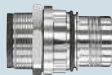

Straight, with central fastening thread, rear mounting, M17, see page 69.



Shielded

Angled, rotatable, M17, see page 68.



Crimp contacts

Female contacts

Turned, see page 70.



All housings can be fitted with male or female crimp contacts

Male contacts

Turned, see page 70.



Tools/accessories

Crimping tools

Crimping pliers with digital display for turned crimp contacts, see page 177.



Tools/accessories

Unlocking tool for device connectors with contact carriers for snapping in from the device side, see page 179.



Color rings for individually marking the connectors, see page 180.

**Note:**

For safety reasons, only use female contacts in the live part of the connector.

Circular connectors

M17 signal connectors

Cable connectors, M17 Compact

- High packing density in a compact product
- Individual marking of connectors with color rings



Cable connector, female assembly



Cable connector, male assembly

Description	Cable clamping area	Ordering data				Ordering data			
		Order No.	Pcs./Pkt.	Order No.	Pcs./Pkt.	Order No.	Pcs./Pkt.	Order No.	Pcs./Pkt.
Cable connector, with contact carrier, without contacts		8-pos.		17-pos.		8-pos.		17-pos.	
	3.5 mm ... 5.5 mm	1613370	1	1613288	1	1618641	1	1618682	1
	5 mm ... 9.2 mm	1613371	1	1613324	1	1618648	1	1618683	1
	9 mm ... 11.2 mm	1613372	1	1613325	1	1618649	1	1618684	1
		Accessories				Accessories			
Crimp contacts		For female contacts, see page 70 onwards				For male contacts, see page 70 onwards			
Color rings, 50 pcs. in set (to be ordered separately)		See page 180				See page 180			
Protective caps (to be ordered separately)		See page 181				See page 181			

Coupler connectors, M17 Compact

- Compatible with mating connectors with SPEEDCON or M17 standard knurled nuts
- Individual marking of connectors with color rings



Coupler connector, female assembly



Coupler connector, male assembly

Description	Cable clamping area	Ordering data				Ordering data			
		Order No.	Pcs./Pkt.	Order No.	Pcs./Pkt.	Order No.	Pcs./Pkt.	Order No.	Pcs./Pkt.
Coupler connector, with contact carrier, without contacts		8-pos.		17-pos.		8-pos.		17-pos.	
	3.5 mm ... 5.5 mm	1618724	1	1618756	1	1617799	1	1613497	1
	5 mm ... 9.2 mm	1618725	1	1618757	1	1617813	1	1613896	1
	9 mm ... 11.2 mm	1618726	1	1618758	1	1617830	1	1614532	1
		Accessories				Accessories			
Crimp contacts		For female contacts, see page 70 onwards				For male contacts, see page 70 onwards			
Color rings, 50 pcs. in set (to be ordered separately)		See page 180				See page 180			
Protective caps (to be ordered separately)		See page 181				See page 181			

**Panel feed-throughs,
M17 Compact**

- Panel feed-throughs suitable for front and rear mounting
- Compatible with mating connectors with SPEEDCON or M17 standard knurled nuts
- Individual marking of connectors with color rings
- **Flange dimensions**
25.7 mm x 25.7 mm



Panel feed-through,
female assembly



Panel feed-through,
male assembly

Ordering data			
Order No.	Pcs./Pkt.	Order No.	Pcs./Pkt.
	8-pos.		17-pos.

Ordering data			
Order No.	Pcs./Pkt.	Order No.	Pcs./Pkt.
	8-pos.		17-pos.

Description	Cable clamping area
Panel feed-through, with contact carrier, without contacts	3.5 mm ... 5.5 mm 5 mm ... 9 mm 9 mm ... 11 mm

Accessories			
For female contacts, see page 70 onwards			
See page 180			
See page 181			

Accessories			
For male contacts, see page 70 onwards			
See page 180			
See page 181			

Crimp contacts
Color rings, 50 pcs. in set (to be ordered separately)
Protective caps (to be ordered separately)

**Device connectors,
M17 Compact,
front mounting**

- Compatible with mating connectors with SPEEDCON or M17 standard knurled nuts
- Individual marking of connectors with color rings
- **Flange dimensions:**
21.6 mm x 21.6 mm



Device connector, straight,
female assembly



Device connector, straight,
male assembly

Ordering data			
Order No.	Pcs./Pkt.	Order No.	Pcs./Pkt.
	8-pos.		17-pos.

Ordering data			
Order No.	Pcs./Pkt.	Order No.	Pcs./Pkt.
	8-pos.		17-pos.

Device connector, with contact carrier, without contacts, contact insert for support on the device	1619039	1	1607654	1
Device connector, with contact carrier, without contacts, contact insert can be snapped in	1619038	1	1607653	1

Accessories			
For female contacts, see page 70 onwards			
See page 180			
See page 181			
See page 179			

Accessories			
For male contacts, see page 70 onwards			
See page 180			
See page 181			
See page 179			

Crimp contacts
Color rings, 50 pcs. in set (to be ordered separately)
Protective caps (to be ordered separately)
Unlocking tool for contact carriers

Circular connectors

M17 signal connectors

Cable connectors, SPEEDCON fast locking system

- Individual marking of connectors with color rings



Cable connector, female assembly



Cable connector, male assembly

Description	Cable clamping area	Ordering data				Ordering data			
		Order No.	Pcs./Pkt.	Order No.	Pcs./Pkt.	Order No.	Pcs./Pkt.	Order No.	Pcs./Pkt.
		8-pos.		17-pos.		8-pos.		17-pos.	
Cable connector, with contact carrier, without contacts									
	5 mm ... 8 mm	1619007	1	1607642	1	1618999	1	1607625	1
	8 mm ... 10 mm	1619008	1	1607644	1	1619000	1	1607627	1
	10 mm ... 12.5 mm	1619009	1	1624532	1	1619001	1	1624529	1
		Accessories				Accessories			
Crimp contacts		For female contacts, see page 70 onwards				For male contacts, see page 70 onwards			
Color rings, 50 pcs. in set (to be ordered separately)		See page 180				See page 180			
Protective caps (to be ordered separately)		See page 181				See page 181			

Cable connectors, M17 standard locking

- Standard knurled nut compatible with mating connectors with SPEEDCON and M17 standard external thread
- Individual marking of connectors with color rings



Cable connector, female assembly



Cable connector, male assembly

Description	Cable clamping area	Ordering data				Ordering data			
		Order No.	Pcs./Pkt.	Order No.	Pcs./Pkt.	Order No.	Pcs./Pkt.	Order No.	Pcs./Pkt.
		8-pos.		17-pos.		8-pos.		17-pos.	
Cable connector, with contact carrier, without contacts									
	5 mm ... 8 mm	1619003	1	1607641	1	1618995	1	1607624	1
	8 mm ... 10 mm	1619004	1	1607643	1	1618996	1	1607626	1
	10 mm ... 12.5 mm	1619005	1	1624531	1	1618997	1	1624528	1
		Accessories				Accessories			
Crimp contacts		For female contacts, see page 70 onwards				For male contacts, see page 70 onwards			
Color rings, 50 pcs. in set (to be ordered separately)		See page 180				See page 180			
Protective caps (to be ordered separately)		See page 181				See page 181			

Coupler connectors

- Compatible with mating connectors with SPEEDCON or M17 standard knurled nuts
- Individual marking of connectors with color rings



Coupler connector, female assembly



Coupler connector, male assembly

Ordering data			
Order No.	Pcs./Pkt.	Order No.	Pcs./Pkt.
	8-pos.		17-pos.

Ordering data			
Order No.	Pcs./Pkt.	Order No.	Pcs./Pkt.
	8-pos.		17-pos.

Description	Cable clamping area
Coupler connector, with contact carrier, without contacts	
	5 mm ... 8 mm
	8 mm ... 10 mm
	10 mm ... 12.5 mm

Accessories			
For female contacts, see page 70 onwards			
See page 180			
See page 181			

Accessories			
For male contacts, see page 70 onwards			
See page 180			
See page 181			

Crimp contacts
Color rings, 50 pcs. in set (to be ordered separately)
Protective caps (to be ordered separately)

Device connectors, straight, front mounting

- Compatible with mating connectors with SPEEDCON or M17 standard knurled nuts
- Contact insert for support on the device or can be snapped in
- Individual marking of connectors with color rings



Device connector, straight, female assembly



Device connector, straight, male assembly

Ordering data			
Order No.	Pcs./Pkt.	Order No.	Pcs./Pkt.
	8-pos.		17-pos.

Ordering data			
Order No.	Pcs./Pkt.	Order No.	Pcs./Pkt.
	8-pos.		17-pos.

Description
Device connector, with contact carrier, without contacts, contact insert for support on the device
Flange dimensions: 25.75 mm x 25.75 mm
Device connector, with contact carrier, without contacts, contact insert can be snapped in
Flange dimensions: 25.75 mm x 25.75 mm

Accessories			
For female contacts, see page 70 onwards			
See page 180			
See page 181			
See page 179			

Accessories			
For male contacts, see page 70 onwards			
See page 180			
See page 181			
See page 179			

Crimp contacts
Color rings, 50 pcs. in set (to be ordered separately)
Protective caps (to be ordered separately)
Unlocking tool for contact carriers

**Device connectors,
central fastening thread,
front and rear mounting**

- Compatible with mating connectors with SPEEDCON or M17 standard knurled nuts
- Snapping in the contact carriers from the device side
- Individual marking of connectors with color rings



Device connector, central fixing, female assembly



Device connector, central fixing, male assembly

Description	Ordering data				Ordering data			
	Order No.	Pcs./Pkt.	Order No.	Pcs./Pkt.	Order No.	Pcs./Pkt.	Order No.	Pcs./Pkt.
Device connector, front mounting, M18 x 0.75 fastening thread, with contact carrier, without contacts	8-pos.		17-pos.		8-pos.		17-pos.	
Device connector, rear mounting, M20 x 1.5 fastening thread, with contact carrier, without contacts	1619036	1	1613542	1	1618584	1	1613540	1
	1619035	1	1613543	1	1619034	1	1613541	1
Description	Accessories			Accessories				
	Type	Order No.	Pcs./Pkt.	Type	Order No.	Pcs./Pkt.		
Locking nut, for mounting bore holes and polarization								
M18 x 0.75	ST-E2015151	1613831	10	ST-E2015151	1613831	10		
M20 x 1.5	RC-13041	1600417	10	RC-13041	1600417	10		
Crimp contacts	For female contacts, see page 70 onwards			For male contacts, see page 70 onwards				
Color rings, 50 pcs. in set (to be ordered separately)	See page 180			See page 180				
Protective caps (to be ordered separately)	See page 181			See page 181				
Unlocking tool for contact carriers	See page 179			See page 179				

Circular connectors

M17 signal connectors

Crimp contacts, turned

Depending on the number of positions, assemble the M17 signal connectors with \varnothing 1.0 mm or \varnothing 0.6 mm contacts.

- 8-pos. versions: contacts with \varnothing 1.0 mm
- 17-pos. versions: contacts with \varnothing 0.6 mm

Note:

Depending on the litz wire used, the connection cross sections (crimp ranges) can differ from the values listed below.



Crimp contact, female



Crimp contact, male

		Ordering data			Ordering data		
Description	Connection cross section [mm ²]	Type	Order No.	Pcs./Pkt.	Type	Order No.	Pcs./Pkt.
Contact female \varnothing 0.6 mm	0.06 ... 0.25	ST-06KS010	1607580	100			
	0.14 ... 0.34	ST-06KS020	1607581	100			
	0.34 ... 0.50	ST-06KS030	1607582	100			
Contact, \varnothing 1.0 mm, for signal	0.06 ... 0.25	ST-10KS010	1618239	100			
	0.34 ... 0.50	ST-10KS020	1618251	100			
	0.25 ... 1.0	ST-10KS035	1618464	100			
Contact male \varnothing 0.6 mm	0.06 ... 0.25				ST-06KP010	1607577	100
	0.14 ... 0.34				ST-06KP020	1607578	100
	0.34 ... 0.50				ST-06KP030	1607579	100
Contact, \varnothing 1.0 mm, for signal	0.06 ... 0.25				ST-10KP010	1618255	100
	0.34 ... 0.50				ST-10KP020	1618256	100
	0.25 ... 1.0				ST-10KP035	1618458	100
		Accessories			Accessories		
Crimping tools		Order separately, see page 177			Order separately, see page 177		

Notes:

Each connector housing type can be assembled with male or female contacts.

For safety reasons, only use female contacts in the live part of the connector.

Mechanical and electrical data

Mechanical data	
Housing material:	Die-cast zinc (GD-Zn)
Housing surface:	Nickel-plated / thick layer passivated (can be coated)
Insulating body:	Thermoplastic polyester (PBT), polyamide (PA 66)
Contact material:	Copper zinc alloy (CuZn)
Contact surface:	Nickel-plated (Ni) with gold coating (Au)
Connection technology:	Crimp connection
Sealing and O-ring:	Fluororubber (FPM)
Temperature range:	-40°C ... 125°C
Cable entry:	External cable diameter 3 to 15 mm
Type of locking:	M23 ONECLICK fast locking system, Cable connector with optional M23 x 1 standard locking
Mechanical insertion cycles:	Standard: 100, punched-rolled crimp contacts: up to 500
Protection class:	IP66/IP68

Electrical data						
Number of positions		6	7	9 (8+1)	12	17
Contacts		6	7	8 + 1	12	17
Contact Ø	[mm]	2	2	1 2	1	1
Litz wire cross section						
Crimp connection: contacts x [mm ²] max.		6 x 2.5	7 x 2.5	8 x 0.56 + 1 x 2.5	12 x 1.0	17 x 1.0
Nominal current per contact at 25°C ¹⁾	[A]	20	20	8 20	8	8
Specifications in accordance with DIN EN 61984:2009						
Rated voltage	[V AC/DC]	300	300	300	150	125
Test/surge voltage	[kV AC]	2.5	2.5	2.5	1.5	2
Overvoltage category		II	II	II	II	II
Pollution degree ²⁾		3	3	3	3	3
Installation altitude	[m]	Up to 2000	Up to 2000	Up to 2000	Up to 2,000	Up to 2000
Cable clamping area ³⁾	Max. Ø [mm]	14.5	14.5	14.5	14.5	15

¹⁾ Determine the effective current carrying capacity depending on the application, if necessary, using a derating curve.

²⁾ The values specified assume that the connector pair is correctly locked and is only disconnected for testing and maintenance purposes. If the connector is unlocked and exposed to ambient conditions, and if there is a danger of pollution, seal the connector using a protective cap ≥ IP54.

³⁾ The cable clamping areas specified on the following pages may vary depending on the cable material and structure. Selection and testing is the responsibility of the user.

Note:

In contrast to connecting equipment, connectors may only be plugged in / unplugged when the power supply is disconnected.

Contact chamber numbering
(view of plug-in side)

Direction of rotation for contact chamber numbering
(view of plug-in side)



Forward running (standard)



Reverse running (standard)

Number of positions

Male

Female

6-pos.

Crimp

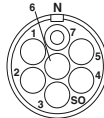
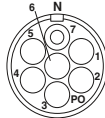

7-pos.

Crimp

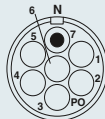

9-pos. (8 + 1)

Crimp

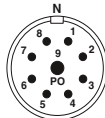

12-pos.

Crimp



17-pos.

Crimp

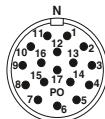

Note:
The connectors can be assembled with male or female contacts depending on the application.

For safety reasons, only use female contacts in the live part of the connector.

Circular connectors

M23 PRO series signal connectors

Selection guide

M23 PRO series signal connectors
12- and 17-pos., up to 8 A 150 V,
crimp connection.

- Cable connectors
- Device connectors (device flanges)

The connectors can be furnished with
the corresponding crimp contacts.

Every housing type can be assembled
with male or female contacts. The product
chart provides an overview of the available
components.

Connector type

Cable connectors, short design

M23 ONECLICK fast locking system,
see page 76.

M23 x 1 standard locking,
see page 76.



ONECLICK Technology [®]
Designed by PHOENIX CONTACT

Shielded

Device connectors

Front mounting,
angled, rotatable,
flange dimensions: 26 mm x 26 mm,
see page 77.



Front mounting,
angled, rotatable,
flange dimensions: 28 mm x 28 mm,
see page 77.



Shielded

For crimp connection:

Tools/accessories

Female contacts

Turned, see page 78.



Punched-rolled, taped, see page 78.



Crimping tools

Crimping pliers for rolled crimp contacts, see page 176.



Crimping pliers with digital display for turned crimp contacts, see page 176.



Female contact
Male contact

All housings can be fitted with male or female crimp contacts

Male contacts

Turned, see page 78.



Punched-rolled, taped, see page 78.

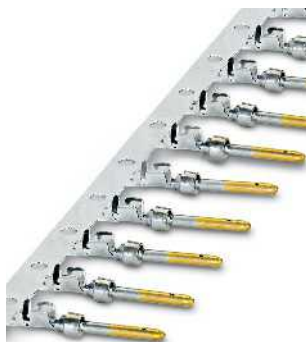

Tools/accessories

Unlocking tool for device connectors for releasing the contact carriers from the plug-in side, see page 179.



Female contact
Male contact

Note:
For safety reasons, only use female contacts in the live part of the connector.

Device connectors, angled, rotatable

- Cross-manufacturer connection compatibility
- All housings can be fitted with male or female contacts

new



Flange dimensions: 26 mm x 26 mm, 12-pos., 17-pos.

new



Flange dimensions: 28 mm x 28 mm, 12-pos., 17-pos.

Ordering data

Order No.	Pcs./Pkt.	Order No.	Pcs./Pkt.
	12-pos.		17-pos.

Ordering data

Order No.	Pcs./Pkt.	Order No.	Pcs./Pkt.
	12-pos.		17-pos.

Description	Cable clamping area
-------------	---------------------

Device connector, angled, rotatable, with contact carrier, without contacts, for female assembly, crimp connection

1628499	1	1628497	1
---------	---	---------	---

1628495	1	1628493	1
---------	---	---------	---

Device connector, angled, rotatable, with contact carrier, without contacts, for male assembly, crimp connection

1628498	1	1628496	1
---------	---	---------	---

1628494	1	1628492	1
---------	---	---------	---

Accessories

Order separately, see page 78 onwards

Accessories

Order separately, see page 78 onwards

Crimp contacts

Crimp contacts

Male and female crimp contacts with various connection cross sections can be ordered for each crimp contact carrier.



Punched-rolled crimp contacts



Turned crimp contacts

ERC

ERC

		Ordering data			Ordering data		
Description	Contacts / connection cross section [mm ²]	Type	Order No.	Pcs./Pkt.	Type	Order No.	Pcs./Pkt.
Crimp contact for contact carriers, 6-pos., 6 x Ø2.0 mm							
	Male Ø 2.0 mm / 1.0 ... 1.5				RC-5CP2000	1603513	50
	Female Ø 2.0 mm / 1.0 ... 1.5				RC-5CS2000	1603517	50
	Male Ø 2.0 mm / 1.5 ... 2.5				RC-5AP2000	1603505	50
	Female Ø 2.0 mm / 1.5 ... 2.5				RC-5AS2000	1603509	50
Crimp contact for contact carriers, 7-pos., 7 x Ø2.0 mm							
	Male Ø 2.0 mm / 1.0 ... 1.5				RC-5CP2000	1603513	50
	Female Ø 2.0 mm / 1.0 ... 1.5				RC-5CS2000	1603517	50
	Male Ø 2.0 mm / 1.5 ... 2.5				RC-5AP2000	1603505	50
	Female Ø 2.0 mm / 1.5 ... 2.5				RC-5AS2000	1603509	50
Crimp contact for contact carriers, 9-pos. (8+1), 8 x Ø1.0 mm, 1 x Ø2.0 mm							
	Male Ø1.0 mm / 0.14 ... 0.56				RC-12P2000	1597862	100
	Female Ø1.0 mm / 0.14 ... 0.56				RC-12S2000	1599600	100
	Male Ø 2.0 mm / 1.5 ... 2.5				RC-5AP2000	1603505	50
	Female Ø 2.0 mm / 1.5 ... 2.5				RC-5AS2000	1603509	50
	Male Ø 2.0 mm / 1.0 ... 1.5				RC-5CP2000	1603513	50
	Female Ø 2.0 mm / 1.0 ... 1.5				RC-5CS2000	1603517	50
Crimp contact for contact carriers, 12-pos., 12 x Ø 1.0 mm and 17-pos., 17 x Ø 1.0 mm							
	Male Ø 1.0 mm / 0.08 ... 0.22				RC-11P2000	1596770	100
	Female Ø 1.0mm / 0.08 ... 0.22				RC-11S2000	1596772	100
	Male Ø1.0 mm / 0.14 ... 0.56				RC-12P2000	1597862	100
	Female Ø1.0 mm / 0.14 ... 0.56				RC-12S2000	1599600	100
	Male Ø 1.0 mm / 0.5 ... 1.0				RC-1KP2000	1602996	100
	Female Ø 1.0mm / 0.5 ... 1.0				RC-1KS2000	1602998	100
Crimp contact for contact carriers, 12-pos., 12 x Ø 1.0 mm and 17-pos., 17 x Ø 1.0 mm							
	Single contact male Ø 1.0 mm / 0.22 ... 0.56	RC-22P2000	1603321	100			
	Single contact female Ø 1.0 mm / 0.22 ... 0.56	RC-22S2000	1603327	100			
	Roll with 500 pieces, male Ø 1.0 mm / 0.22 ... 0.56	RC-22P2300	1603324	1			
	Roll with 500 pieces, female Ø 1.0 mm / 0.22 ... 0.56	RC-22S2300	1603330	1			
	Roll with 10,000 pieces, male Ø 1.0 mm / 0.22 ... 0.56	RC-22P2400	1603325	1			
	Roll with 10,000 pieces, female Ø 1.0 mm / 0.22 ... 0.56	RC-22S2400	1603332	1			
		Accessories			Accessories		
Crimping tools		See page 176			See page 176		

Mechanical and electrical data

Mechanical data	
Housing material:	Copper zinc alloy (CuZn), die-cast zinc (GD-Zn)
Housing surface:	Nickel-plated / thick layer passivated (can be coated)
Insulating body:	Thermoplastic polyester (PBT), polyamide (PA 66)
Contact material:	Copper zinc alloy (CuZn)
Contact surface:	Nickel-plated (Ni) with gold coating (Au)
Connection technology:	Solder cup, crimp connection, solder pin
Sealing and O-ring:	NBR
Flat gasket:	NBR, fiber-reinforced NBR
Temperature range:	-40°C ... 125°C
Cable entry:	Cable and coupler connectors for an outer cable diameter of 3 to 14.5 mm, shielded
Type of locking:	M23 SPEEDCON fast locking system, cable connector with M23 x 1 coarse-pitch thread as an option
Mechanical insertion cycles:	Standard: 100, punched-rolled C-HC crimp contacts: up to 500
Protection class:	IP67 when locked

Electrical data									
Number of positions	6	7	9 (8+1)		12	17	19 (16+3)		19 (16+2+PE)
Contacts	6	7	8 + 1		12	17	16 + 3		16 + 2+PE
Contact Ø [mm]	2	2	1	2	1	1	1	1.5	1 1.5
Litz wire cross section									
Solder connection: contacts x [mm²] max.	6 x 2.5	7 x 2.5	8 x 1.0 + 1 x 2.5		12 x 1.0	17 x 1.0	16 x 1.0 + 3 x 1.0		–
Crimp connection: contacts x [mm²] max.	6 x 2.5	7 x 2.5	8 x 0.56 + 1 x 2.5		12 x 0.56	17 x 0.56	–		16 x 1.0 + 3 x 1.0
Nominal current per contact at 25°C ¹⁾ [A]	20	20	8	20	8	8	8	10	8 10
Specifications in accordance with DIN EN 61984:2009									
Rated voltage [V AC/DC]	300	300	300		150	150	150		150
Test/surge voltage [kV AC]	2.5	2.5	2.5		1.5	1.5	1.5		1.5
Overvoltage category	II	II	II		II	II	II		II
Pollution degree ²⁾	3	3	3		3	3	3		3
Installation altitude [m]	Up to 2000	Up to 2000	Up to 2000		Up to 2000	Up to 2000	Up to 2000		Up to 2000
Cable clamping area ³⁾ Max. Ø [mm]	14.5	14.5	14.5		14.5	14.5	14.5		14.5

¹⁾ Determine the effective current carrying capacity depending on the application, if necessary, using a derating curve.

²⁾ The values specified assume that the connector pair is correctly locked and is only disconnected for testing and maintenance purposes. If the connector is unlocked and exposed to ambient conditions, and if there is a danger of pollution, seal the connector using a protective cap ≥ IP54.

³⁾ The cable clamping areas specified on the following pages may vary depending on the cable material and structure. Selection and testing is the responsibility of the user.

Note:

In contrast to connecting equipment, connectors may only be plugged in / unplugged when the power supply is disconnected.

Contact chamber numbering (view of plug-in side)

Direction of rotation for
contact chamber numbering
(view of plug-in side)

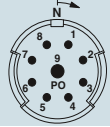

Forward running (standard)

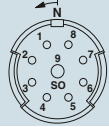

Reverse running (standard)

Number of positions

Male

Female

6-pos.

Solder / crimp / solder-in

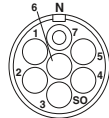
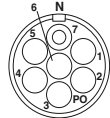

7-pos.

Solder / crimp / solder-in

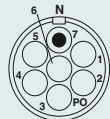

9-pos. (8 + 1)

Solder / crimp / solder-in

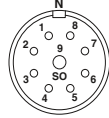
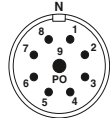

12-pos.

Solder / crimp / solder-in



17-pos.

Solder / crimp / solder-in

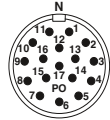

19-pos. (16 + 3)

Solder



19-pos. (16 + 2 + PE)

Crimp

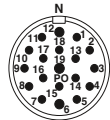

Note:

The connectors can be assembled with male or female contacts depending on the application.

For safety reasons, only use female contacts in the live part of the connector.

Circular connectors

M23 signal connectors

Selection guide

M23 signal connectors
6- to 19-pos., up to 20 A / 300 V,
solder, crimp, and solder-in connection.

- Cable connectors
- Coupler connectors
- Device connectors (device flanges)

In the case of crimp connection, the respective crimp contacts must be added depending on the connection cross section.

Every housing type can be assembled with male or female contacts. The product chart provides an overview of the available components.

Connector type

Cable connectors

SPEEDCON fast locking system, see page 84.

M23 x 1 standard locking, see page 86.

Shielded



Coupler connectors

See page 88.

Shielded



Device connectors

Front mounting,
Pg13.5 fastening thread,
see page 94.

Front mounting,
M20 fastening thread,
see phoenixcontact.net/products

Shielded



Front mounting,
flange dimensions: 25 mm x 25 mm,
see page 100.

Front mounting, solder-in connection,
flange dimensions: 25 mm x 25 mm,
see phoenixcontact.net/products



Front mounting,
angled, rotatable,
flange dimensions: 26 mm x 26 mm,
see page 104.



Rear mounting,
central fixing nut,
see page 102.



For crimp connection:

Female contacts

Turned, see page 105.



Punched-rolled, taped, see page 105.



Male contacts

Turned, see page 105.



Punched-rolled, taped, see page 105.

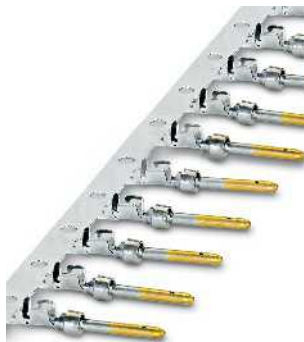

All housings can be fitted with male or female crimp contacts

Tools/accessories

Crimping tools

Crimping pliers for rolled crimp contacts, see page 176.



Crimping pliers with digital display for turned crimp contacts, see page 176.



Tools/accessories

Unlocking tool for device connectors for releasing the contact carriers from the plug-in side, see page 179.



Color rings for individually marking the connectors, see page 180.

**Note:**

For safety reasons, only use female contacts in the live part of the connector.

Circular connectors

M23 signal connectors

Cable connectors, SPEEDCON fast locking system

- 6- to 19-pos. versions, solder or crimp connection
- Individual marking of connectors with color rings



6- and 7-pos.



8+1-pos., 12-pos.

Description	Cable clamping area	Ordering data				Ordering data			
		Order No.	Pcs./Pkt.	Order No.	Pcs./Pkt.	Order No.	Pcs./Pkt.	Order No.	Pcs./Pkt.
		6-pos.		7-pos.		8+1-pos.		12-pos.	
Cable connector, with contact carrier, with female contacts, solder connection									
Universal gasket	3 mm ... 14.5 mm	1619605	1	1619601	1	1619597	1	1619593	1
	4 mm ... 6 mm	1619579	1	1619575	1	1619571	1	1619567	1
	6 mm ... 10 mm	1619534	1	1619530	1	1619526	1	1619522	1
	10 mm ... 14.5 mm	1619508	1	1619504	1	1619500	1	1619496	1
Cable connector, with contact carrier, with male contacts, solder connection									
Universal gasket	3 mm ... 14.5 mm	1619604	1	1619600	1	1619596	1	1619592	1
	4 mm ... 6 mm	1619578	1	1619574	1	1619570	1	1619548	1
	6 mm ... 10 mm	1619533	1	1619529	1	1619525	1	1619521	1
	10 mm ... 14.5 mm	1619507	1	1619503	1	1619499	1	1619495	1
Cable connector, with contact carrier, without contacts, for female assembly, crimp connection									
Universal gasket	3 mm ... 14.5 mm	1619603	1	1619599	1	1619595	1	1619591	1
	4 mm ... 6 mm	1619577	1	1619573	1	1619569	1	1619547	1
	6 mm ... 10 mm	1619532	1	1619528	1	1619524	1	1619520	1
	10 mm ... 14.5 mm	1619506	1	1619502	1	1619498	1	1619489	1
Cable connector, with contact carrier, without contacts, for male assembly, crimp connection									
Universal gasket	3 mm ... 14.5 mm	1619602	1	1619598	1	1619594	1	1619590	1
	4 mm ... 6 mm	1619576	1	1619572	1	1619568	1	1619546	1
	6 mm ... 10 mm	1619531	1	1619527	1	1619523	1	1619519	1
	10 mm ... 14.5 mm	1619505	1	1619501	1	1619497	1	1619488	1
Accessories									
For crimp connection: crimp contacts		Order separately, see page 105 onwards				Order separately, see page 105 onwards			
Color rings, 50 pcs. in set (to be ordered separately)		See page 180				See page 180			
Protective caps (to be ordered separately)		See page 181				See page 181			



17-pos., 16+3-pos.



16+2+PE-pos.

Ordering data				Ordering data			
Order No.	Pcs./Pkt.	Order No.	Pcs./Pkt.	Order No.	Pcs./Pkt.	Order No.	Pcs./Pkt.
17-pos.		16+3-pos.		16+2+PE-pos.			
1619585	1	1619581	1				
1619541	1	1619537	1				
1619514	1	1619510	1				
1619483	1	1619479	1				
1619584	1	1619580	1				
1619540	1	1619536	1				
1619513	1	1619509	1				
1619482	1	1619478	1				
1619583	1	1623838	1				
1619539	1	1623836	1				
1619512	1	1623834	1				
1619481	1	1623832	1				
1619582	1	1623837	1				
1619538	1	1623835	1				
1619511	1	1623833	1				
1619480	1	1623831	1				
Accessories				Accessories			
Order separately, see page 105 onwards				Order separately, see page 105 onwards			
See page 180				See page 180			
See page 181				See page 181			

Circular connectors

M23 signal connectors

Cable connectors, M23 standard locking

- Standard knurled nut compatible with mating connectors with SPEEDCON and M23 standard external thread
- 6- to 19-pos. versions, solder or crimp connection
- Individual marking of connectors with color rings



6- and 7-pos.



8+1-pos., 12-pos.

Description	Cable clamping area	Ordering data				Ordering data			
		Order No.	Pcs./Pkt.	Order No.	Pcs./Pkt.	Order No.	Pcs./Pkt.	Order No.	Pcs./Pkt.
		6-pos.		7-pos.		8+1-pos.		12-pos.	
Cable connector, with contact carrier, with female contacts, solder connection									
Universal gasket	3 mm ... 14.5 mm	1619776	1	1619772	1	1619768	1	1619764	1
	4 mm ... 6 mm	1619750	1	1619746	1	1619742	1	1619738	1
	6 mm ... 10 mm	1619724	1	1619720	1	1619716	1	1619710	1
	10 mm ... 14.5 mm	1619659	1	1619655	1	1619651	1	1619647	1
Cable connector, with contact carrier, with male contacts, solder connection									
Universal gasket	3 mm ... 14.5 mm	1619775	1	1619771	1	1619767	1	1619763	1
	4 mm ... 6 mm	1619749	1	1619745	1	1619741	1	1619737	1
	6 mm ... 10 mm	1619723	1	1619719	1	1619715	1	1619709	1
	10 mm ... 14.5 mm	1619658	1	1619654	1	1619650	1	1619646	1
Cable connector, with contact carrier, without contacts, for female assembly, crimp connection									
Universal gasket	3 mm ... 14.5 mm	1619774	1	1619770	1	1619766	1	1619762	1
	4 mm ... 6 mm	1619748	1	1619744	1	1619740	1	1619736	1
	6 mm ... 10 mm	1619722	1	1619718	1	1619714	1	1619708	1
	10 mm ... 14.5 mm	1619657	1	1619653	1	1619649	1	1619645	1
Cable connector, with contact carrier, without contacts, for male assembly, crimp connection									
Universal gasket	3 mm ... 14.5 mm	1619773	1	1619769	1	1619765	1	1619761	1
	4 mm ... 6 mm	1619747	1	1619743	1	1619739	1	1619735	1
	6 mm ... 10 mm	1619721	1	1619717	1	1619711	1	1619707	1
	10 mm ... 14.5 mm	1619656	1	1619652	1	1619648	1	1619644	1
Accessories									
For crimp connection: crimp contacts	Order separately, see page 105 onwards								
Color rings, 50 pcs. in set (to be ordered separately)	See page 180								
Protective caps (to be ordered separately)	See page 181								



17-pos., 16+3-pos.



16+2+PE-pos.

Ordering data				Ordering data			
Order No.	Pcs./Pkt.	Order No.	Pcs./Pkt.	Order No.	Pcs./Pkt.	Order No.	Pcs./Pkt.
17-pos.		16+3-pos.		16+2+PE-pos.			
1619756	1	1619752	1				
1619730	1	1619726	1				
1619702	1	1619661	1				
1619639	1	1619635	1				
1619755	1	1619751	1				
1619729	1	1619725	1				
1619701	1	1619660	1				
1619638	1	1619634	1				
1619754	1	1623846	1				
1619728	1	1623844	1				
1619700	1	1623842	1				
1619637	1	1623840	1				
1619753	1	1623845	1				
1619727	1	1623843	1				
1619699	1	1623841	1				
1619636	1	1623839	1				
Accessories				Accessories			
Order separately, see page 105 onwards				Order separately, see page 105 onwards			
See page 180				See page 180			
See page 181				See page 181			

Circular connectors

M23 signal connectors

Coupler connectors

- Compatible with mating connectors with SPEEDCON and M23 standard knurled nut
- 6- to 19-pos. versions, solder or crimp connection
- Individual marking of connectors with color rings



6- and 7-pos.



8+1-pos., 12-pos.

Description	Cable clamping area	Ordering data				Ordering data			
		Order No.	Pcs./Pkt.	Order No.	Pcs./Pkt.	Order No.	Pcs./Pkt.	Order No.	Pcs./Pkt.
		6-pos.		7-pos.		8+1-pos.		12-pos.	
Coupler connector, with contact carrier, with female contacts, solder connection									
Universal gasket	3 mm ... 14.5 mm	1620172	1	1620168	1	1620164	1	1620160	1
	4 mm ... 6 mm	1620145	1	1620141	1	1620137	1	1620133	1
	6 mm ... 10 mm	1620119	1	1620115	1	1620079	1	1620075	1
	10 mm ... 14.5 mm	1620046	1	1620042	1	1620036	1	1620032	1
Coupler connector, with contact carrier, with male contacts, solder connection									
Universal gasket	3 mm ... 14.5 mm	1620171	1	1620167	1	1620163	1	1620159	1
	4 mm ... 6 mm	1620144	1	1620140	1	1620136	1	1620132	1
	6 mm ... 10 mm	1620118	1	1620114	1	1620078	1	1620074	1
	10 mm ... 14.5 mm	1620045	1	1620041	1	1620035	1	1620031	1
Coupler connector, with contact carrier, without contacts, for female assembly, crimp connection									
Universal gasket	3 mm ... 14.5 mm	1620170	1	1620166	1	1620162	1	1620158	1
	4 mm ... 6 mm	1620143	1	1620139	1	1620135	1	1620131	1
	6 mm ... 10 mm	1620117	1	1620081	1	1620077	1	1620073	1
	10 mm ... 14.5 mm	1620044	1	1620038	1	1620034	1	1620030	1
Coupler connector, with contact carrier, without contacts, for male assembly, crimp connection									
Universal gasket	3 mm ... 14.5 mm	1620169	1	1620165	1	1620161	1	1620157	1
	4 mm ... 6 mm	1620142	1	1620138	1	1620134	1	1620130	1
	6 mm ... 10 mm	1620116	1	1620080	1	1620076	1	1620072	1
	10 mm ... 14.5 mm	1620043	1	1620037	1	1620033	1	1620029	1
Accessories									
For crimp connection: crimp contacts		Order separately, see page 105 onwards				Order separately, see page 105 onwards			
Color rings, 50 pcs. in set (to be ordered separately)		See page 180				See page 180			
Protective caps (to be ordered separately)		See page 181				See page 181			



17-pos., 16+3-pos.



16+2+PE-pos.

Ordering data				Ordering data			
Order No.	Pcs./Pkt.	Order No.	Pcs./Pkt.	Order No.	Pcs./Pkt.	Order No.	Pcs./Pkt.
17-pos.		16+3-pos.		16+2+PE-pos.			
1620151	1	1620147	1				
1620125	1	1620121	1				
1620052	1	1620048	1				
1620024	1	1620020	1				
1620150	1	1620146	1				
1620124	1	1620120	1				
1620051	1	1620047	1				
1620023	1	1620019	1				
1620149	1			1624006	1		
1620123	1			1624009	1		
1620050	1			1624008	1		
1620022	1			1624007	1		
1620148	1			1624010	1		
1620122	1			1624013	1		
1620049	1			1624012	1		
1620021	1			1624011	1		
Accessories				Accessories			
Order separately, see page 105 onwards				Order separately, see page 105 onwards			
See page 180				See page 180			
See page 181				See page 181			

Circular connectors

M23 signal connectors

Cable connectors, angled, SPEEDCON fast locking system

- 6- to 19-pos. versions, solder or crimp connection
- Individual marking of connectors with color rings
- 8 different cable outlet directions can be set



6- and 7-pos.



8+1-pos., 12-pos.

Description	Cable clamping area	Ordering data				Ordering data			
		Order No.	Pcs./Pkt.	Order No.	Pcs./Pkt.	Order No.	Pcs./Pkt.	Order No.	Pcs./Pkt.
		6-pos.		7-pos.		8+1-pos.		12-pos.	
Cable connector, angled, with contact carrier, with female contacts, solder connection									
Universal gasket	3 mm ... 14.5 mm	1619450	1	1619446	1	1619442	1	1619438	1
	4 mm ... 6 mm	1619424	1	1619420	1	1619416	1	1619412	1
	6 mm ... 10 mm	1619398	1	1619394	1	1619390	1	1619386	1
	10 mm ... 14.5 mm	1619372	1	1619366	1	1619362	1	1619358	1
Cable connector, angled, with contact carrier, with male contacts, solder connection									
Universal gasket	3 mm ... 14.5 mm	1619449	1	1619445	1	1619441	1	1619437	1
	4 mm ... 6 mm	1619423	1	1619419	1	1619415	1	1619411	1
	6 mm ... 10 mm	1619397	1	1619393	1	1619389	1	1619385	1
	10 mm ... 14.5 mm	1619371	1	1619365	1	1619361	1	1619357	1
Cable connector, angled, with contact carrier, without contacts, for female assembly, crimp connection									
Universal gasket	3 mm ... 14.5 mm	1619448	1	1619444	1	1619440	1	1619436	1
	4 mm ... 6 mm	1619422	1	1619418	1	1619414	1	1619410	1
	6 mm ... 10 mm	1619396	1	1619392	1	1619388	1	1619384	1
	10 mm ... 14.5 mm	1619368	1	1619364	1	1619360	1	1619356	1
Cable connector, angled, with contact carrier, without contacts, for male assembly, crimp connection									
Universal gasket	3 mm ... 14.5 mm	1619447	1	1619443	1	1619439	1	1619435	1
	4 mm ... 6 mm	1619421	1	1619417	1	1619413	1	1619409	1
	6 mm ... 10 mm	1619395	1	1619391	1	1619387	1	1619383	1
	10 mm ... 14.5 mm	1619367	1	1619363	1	1619359	1	1619354	1
Accessories									
For crimp connection: crimp contacts		Order separately, see page 105 onwards				Order separately, see page 105 onwards			
Color rings, 50 pcs. in set (to be ordered separately)		See page 180				See page 180			
Protective caps (to be ordered separately)		See page 181				See page 181			



17-pos., 16+3-pos.



16+2+PE-pos.

Ordering data				Ordering data			
Order No.	Pcs./Pkt.	Order No.	Pcs./Pkt.	Order No.	Pcs./Pkt.	Order No.	Pcs./Pkt.
17-pos.		16+3-pos.					
1619430	1	1619426	1				
1619404	1	1619400	1				
1619378	1	1619374	1				
1619349	1	1619345	1				
1619429	1	1619425	1				
1619403	1	1619399	1				
1619377	1	1619373	1				
1619348	1	1619344	1				
1619428	1	1624080	1				
1619402	1	1624081	1				
1619376	1	1624082	1				
1619347	1	1624083	1				
1619427	1	1624084	1				
1619401	1	1624085	1				
1619375	1	1624086	1				
1619346	1	1624087	1				
Accessories				Accessories			
Order separately, see page 105 onwards				Order separately, see page 105 onwards			
See page 180				See page 180			
See page 181				See page 181			

Circular connectors

M23 signal connectors

Cable connectors, angled, M23 standard locking

- Standard knurled nut compatible with mating connectors with SPEEDCON and M23 standard external thread
- 6- to 19-pos. versions, solder or crimp connection
- Individual marking of connectors with color rings
- 8 different cable outlet directions can be set



6- and 7-pos.



8+1-pos., 12-pos.

Description	Cable clamping area	Ordering data				Ordering data			
		Order No.	Pcs./Pkt.	Order No.	Pcs./Pkt.	Order No.	Pcs./Pkt.	Order No.	Pcs./Pkt.
		6-pos.		7-pos.		8+1-pos.		12-pos.	
Cable connector, with contact carrier, with female contacts, solder connection									
Universal gasket	3 mm ... 14.5 mm	1619343	1	1619339	1	1619335	1	1619331	1
	4 mm ... 6 mm	1620291	1	1620287	1	1620283	1	1620279	1
	6 mm ... 10 mm	1620262	1	1620258	1	1620254	1	1620250	1
	10 mm ... 14.5 mm	1620212	1	1620208	1	1620190	1	1620186	1
Cable connector, angled, with contact carrier, with male contacts, solder connection									
Universal gasket	3 mm ... 14.5 mm	1619342	1	1619338	1	1619334	1	1619330	1
	4 mm ... 6 mm	1620290	1	1620286	1	1620282	1	1620278	1
	6 mm ... 10 mm	1620261	1	1620257	1	1620253	1	1620249	1
	10 mm ... 14.5 mm	1620211	1	1620207	1	1620189	1	1620185	1
Cable connector, angled, with contact carrier, without contacts, for female assembly, crimp connection									
Universal gasket	3 mm ... 14.5 mm	1619341	1	1619337	1	1619333	1	1620303	1
	4 mm ... 6 mm	1620289	1	1620285	1	1620281	1	1620277	1
	6 mm ... 10 mm	1620260	1	1620256	1	1620252	1	1620248	1
	10 mm ... 14.5 mm	1620210	1	1620192	1	1620188	1	1620184	1
Cable connector, angled, with contact carrier, without contacts, for male assembly, crimp connection									
Universal gasket	3 mm ... 14.5 mm	1619340	1	1619336	1	1619332	1	1620302	1
	4 mm ... 6 mm	1620288	1	1620284	1	1620280	1	1620276	1
	6 mm ... 10 mm	1620259	1	1620255	1	1620251	1	1620247	1
	10 mm ... 14.5 mm	1620209	1	1620191	1	1620187	1	1620183	1
Accessories									
For crimp connection: crimp contacts		Order separately, see page 105 onwards				Order separately, see page 105 onwards			
Color rings, 50 pcs. in set (to be ordered separately)		See page 180				See page 180			
Protective caps (to be ordered separately)		See page 181				See page 181			



17-pos., 16+3-pos.



16+2+PE-pos.

Ordering data				Ordering data			
Order No.	Pcs./Pkt.	Order No.	Pcs./Pkt.	Order No.	Pcs./Pkt.	Order No.	Pcs./Pkt.
17-pos.		16+3-pos.					
1620297	1	1620293	1				
1620268	1	1620264	1				
1620218	1	1620214	1				
1620178	1	1620174	1				
1620296	1	1620292	1				
1620267	1	1620263	1				
1620217	1	1620213	1				
1620177	1	1620173	1				
1620295	1	1624071	1				
1620266	1	1624072	1				
1620216	1	1624073	1				
1620176	1	1624074	1				
1620294	1	1624075	1				
1620265	1	1624076	1				
1620215	1	1624077	1				
1620175	1	1624078	1				
Accessories				Accessories			
Order separately, see page 105 onwards				Order separately, see page 105 onwards			
See page 180				See page 180			
See page 181				See page 181			

Circular connectors

M23 signal connectors

Device connectors, front mounting

– Pg13.5 fastening thread

- Compatible with mating connectors with SPEEDCON and M23 standard knurled nut
- 6- to 19-pos. versions, solder or crimp connection
- Individual marking of connectors with color rings



6- and 7-pos.



8+1-pos., 12-pos.

Description	Ordering data				Ordering data			
	Order No.	Pcs./Pkt.	Order No.	Pcs./Pkt.	Order No.	Pcs./Pkt.	Order No.	Pcs./Pkt.
Device connector, with contact carrier, with female contacts, solder connection, Pg13.5 central fastening thread, axial seal								
		6-pos.		7-pos.		8+1-pos.		12-pos.
Device connector, with contact carrier, with male contacts, solder connection, Pg13.5 central fastening thread, axial seal	1619903	1	1619899	1	1619895	1	1619891	1
Device connector, with contact carrier, without contacts, for female assembly, crimp connection, Pg13.5 central fastening thread, axial seal	1619902	1	1619898	1	1619894	1	1619890	1
Device connector, with contact carrier, without contacts, for male assembly, crimp connection, Pg13.5 central fastening thread, axial seal	1619901	1	1619897	1	1619893	1	1619889	1
	1619900	1	1619896	1	1619892	1	1619888	1
Accessories				Accessories				
For crimp connection: crimp contacts	Order separately, see page 105 onwards				Order separately, see page 105 onwards			
Color rings, 50 pcs. in set (to be ordered separately)	See page 180				See page 180			
Protective caps (to be ordered separately)	See page 181				See page 181			



17-pos., 16+3-pos.



16+2+PE-pos.

Ordering data				Ordering data			
Order No.	Pcs./Pkt.	Order No.	Pcs./Pkt.	Order No.	Pcs./Pkt.	Order No.	Pcs./Pkt.
17-pos.		16+3-pos.		16+2+PE-pos.			
1619883	1	1619879	1				
1619882	1	1619878	1				
1619881	1			1624019	1		
1619880	1			1624018	1		
Accessories				Accessories			
Order separately, see page 105 onwards				Order separately, see page 105 onwards			
See page 180				See page 180			
See page 181				See page 181			

Circular connectors

M23 signal connectors

Device connectors, front mounting

– M20 fastening thread

- Compatible with mating connectors with SPEEDCON and M23 standard knurled nut
- 6- to 19-pos. versions, solder or crimp connection
- Individual marking of connectors with color rings



6- and 7-pos.



8+1-pos., 12-pos.

Description	Ordering data				Ordering data			
	Order No.	Pcs./Pkt.	Order No.	Pcs./Pkt.	Order No.	Pcs./Pkt.	Order No.	Pcs./Pkt.
Device connector, with contact carrier, with female contacts, solder connection, M20 central fastening thread, axial seal								
		6-pos.		7-pos.		8+1-pos.		12-pos.
Device connector, with contact carrier, with male contacts, solder connection, M20 central fastening thread, axial seal	1619877	1	1619873	1	1619869	1	1619865	1
Device connector, with contact carrier, without contacts, for female assembly, crimp connection, M20 central fastening thread, axial seal	1619876	1	1619872	1	1619868	1	1619864	1
Device connector, with contact carrier, without contacts, for male assembly, crimp connection, M20 central fastening thread, axial seal	1619875	1	1619871	1	1619867	1	1619863	1
	1619874	1	1619870	1	1619866	1	1619862	1
Accessories								
Description	Accessories			Accessories				
	Type	Order No.	Pcs./Pkt.	Type	Order No.	Pcs./Pkt.		
Locking nut, for mounting bore holes and polarization								
M20 x 1.5	RC-13041	1600417	10	RC-13041	1600417	10		
For crimp connection: crimp contacts	Order separately, see page 105 onwards			Order separately, see page 105 onwards				
Color rings, 50 pcs. in set (to be ordered separately)	See page 180			See page 180				
Protective caps (to be ordered separately)	See page 181			See page 181				



17-pos., 16+3-pos.



16+2+PE-pos.

Ordering data				Ordering data			
Order No.	Pcs./Pkt.	Order No.	Pcs./Pkt.	Order No.	Pcs./Pkt.	Order No.	Pcs./Pkt.
17-pos.		16+3-pos.		16+2+PE-pos.			
1619857	1	1619853	1				
1619856	1	1619852	1				
1619855	1			1624017	1		
1619854	1			1624016	1		
Accessories				Accessories			
Type	Order No.	Pcs./Pkt.		Type	Order No.	Pcs./Pkt.	
RC-13041	1600417	10		RC-13041	1600417	10	
Order separately, see page 105 onwards				Order separately, see page 105 onwards			
See page 180				See page 180			
See page 181				See page 181			

Circular connectors

M23 signal connectors

Device connectors, front mounting, can be positioned

– M20 fastening thread

- Compatible with mating connectors with SPEEDCON and M23 standard knurled nut
- 6- to 19-pos. versions, solder or crimp connection
- Individual marking of connectors with color rings



6- and 7-pos.



8+1-pos., 12-pos.

Description	Ordering data				Ordering data				
	Order No.	Pcs./Pkt.	Order No.	Pcs./Pkt.	Order No.	Pcs./Pkt.	Order No.	Pcs./Pkt.	
Device connector, with contact carrier, with female contacts, solder connection, M20 central fastening thread, axial seal									
		6-pos.		7-pos.		8+1-pos.		12-pos.	
Device connector, with contact carrier, with male contacts, solder connection, M20 central fastening thread, axial seal	1624045	1	1624047	1	1624049	1	1624051	1	
Device connector, with contact carrier, without contacts, for female assembly, crimp connection, M20 central fastening thread, axial seal	1624044	1	1624046	1	1624048	1	1624050	1	
Device connector, with contact carrier, without contacts, for male assembly, crimp connection, M20 central fastening thread, axial seal	1624030	1	1624031	1	1624032	1	1624033	1	
	1624022	1	1624023	1	1624024	1	1624026	1	
Accessories									
Description	Type			Order No.	Pcs./Pkt.	Type			
	Order No.			Order No.	Pcs./Pkt.	Order No.			
Locking nut, for mounting bore holes and polarization	RC-13041			1600417	10	RC-13041			
M20 x 1.5	RC-13041			1600417	10	RC-13041			
For crimp connection: crimp contacts	Order separately, see page 105 onwards			Order separately, see page 105 onwards					
Color rings, 50 pcs. in set (to be ordered separately)	See page 180			See page 180					
Protective caps (to be ordered separately)	See page 181			See page 181					



17-pos., 16+3-pos.



16+2+PE-pos.

Ordering data				Ordering data			
Order No.	Pcs./Pkt.	Order No.	Pcs./Pkt.	Order No.	Pcs./Pkt.	Order No.	Pcs./Pkt.
17-pos.		16+3-pos.		16+2+PE-pos.			
1624056	1	1624058	1				
1624055	1	1624057	1				
1624035	1			1623629	1		
1624029	1			1623630	1		
Accessories				Accessories			
Type	Order No.	Pcs./Pkt.		Type	Order No.	Pcs./Pkt.	
RC-13041	1600417	10		RC-13041	1600417	10	
Order separately, see page 105 onwards				Order separately, see page 105 onwards			
See page 180				See page 180			
See page 181				See page 181			

Circular connectors

M23 signal connectors

Device connectors, front mounting

- **Flange dimensions: 25 mm x 25 mm**
- Compatible with mating connectors with SPEEDCON and M23 standard knurled nut
- 6- to 19-pos. versions, solder or crimp connection
- Individual marking of connectors with color rings



6- and 7-pos.



8+1-pos., 12-pos.

Description	Ordering data				Ordering data			
	Order No.	Pcs./Pkt.	Order No.	Pcs./Pkt.	Order No.	Pcs./Pkt.	Order No.	Pcs./Pkt.
	6-pos.		7-pos.		8+1-pos.		12-pos.	
Device connector, with contact carrier, with female contacts, solder connection, flat gasket	1619993	1	1619989	1	1619973	1	1619969	1
Device connector, with contact carrier, with male contacts, solder connection, flat gasket	1619992	1	1619988	1	1619972	1	1619968	1
Device connector, with contact carrier, without contacts, for female assembly, crimp connection, flat gasket	1619991	1	1619987	1	1619971	1	1619967	1
Device connector, with contact carrier, without contacts, for male assembly, crimp connection, flat gasket	1619990	1	1619986	1	1619970	1	1619966	1
	Accessories				Accessories			
For crimp connection: crimp contacts	Order separately, see page 105 onwards				Order separately, see page 105 onwards			
Color rings, 50 pcs. in set (to be ordered separately)	See page 180				See page 180			
Protective caps (to be ordered separately)	See page 181				See page 181			



17-pos., 16+3-pos.



16+2+PE-pos.

Ordering data				Ordering data			
Order No.	Pcs./Pkt.	Order No.	Pcs./Pkt.	Order No.	Pcs./Pkt.	Order No.	Pcs./Pkt.
17-pos.		16+3-pos.		16+2+PE-pos.			
1619961	1	1619957	1				
1619960	1	1619956	1				
1619959	1			1624015	1		
1619958	1			1624014	1		
Accessories				Accessories			
Order separately, see page 105 onwards				Order separately, see page 105 onwards			
See page 180				See page 180			
See page 181				See page 181			

Circular connectors

M23 signal connectors

Device connectors, rear mounting

- Compatible with mating connectors with SPEEDCON and M23 standard knurled nut
- 6- to 19-pos. versions, solder or crimp connection
- Individual marking of connectors with color rings



6- and 7-pos.



8+1-pos., 12-pos.

Description	Ordering data				Ordering data			
	Order No.	Pcs./Pkt.	Order No.	Pcs./Pkt.	Order No.	Pcs./Pkt.	Order No.	Pcs./Pkt.
	6-pos.		7-pos.		8+1-pos.		12-pos.	
Device connector, with contact carrier, with female contacts, solder connection, central fixing nut, axial seal	1619851	1	1619847	1	1619843	1	1619790	1
Device connector, with contact carrier, with male contacts, solder connection, central fixing nut, axial seal	1619850	1	1619846	1	1619842	1	1619789	1
Device connector, with contact carrier, without contacts, for female assembly, crimp connection, central fixing nut, axial seal	1619849	1	1619845	1	1619841	1	1619788	1
Device connector, with contact carrier, without contacts, for male assembly, crimp connection, central fixing nut, axial seal	1619848	1	1619844	1	1619791	1	1619787	1
	Accessories				Accessories			
For crimp connection: crimp contacts	Order separately, see page 105 onwards				Order separately, see page 105 onwards			
Color rings, 50 pcs. in set (to be ordered separately)	See page 180				See page 180			
Protective caps (to be ordered separately)	See page 181				See page 181			



17-pos., 16+3-pos.



16+3-pos., 16+2+PE-pos.

Ordering data				Ordering data			
Order No.	Pcs./Pkt.	Order No.	Pcs./Pkt.	Order No.	Pcs./Pkt.	Order No.	Pcs./Pkt.
17-pos.		16+3-pos.		16+2+PE-pos.			
1619782	1	1619778	1				
1619781	1	1619777	1				
1619780	1			1624021	1		
1619779	1			1624020	1		
Accessories				Accessories			
Order separately, see page 105 onwards				Order separately, see page 105 onwards			
See page 180				See page 180			
See page 181				See page 181			

Circular connectors

M23 signal connectors

Device connectors, angled, rotatable, front mounting

- Compatible with mating connectors with SPEEDCON and M23 standard knurled nut
- Flange dimensions: 26 mm x 26 mm



8+1-, 12-, 17-pos.

Ordering data

Description	Order No.	Pcs./Pkt.	Order No.	Pcs./Pkt.	Order No.	Pcs./Pkt.
	8+1-pos.		12-pos.		17-pos.	
Device connector, with contact carrier, with male contacts, solder connection, angled, rotatable, axial seal	1621746	1	1621741	1	1621745	1
Device connector, with contact carrier, without contacts, for male assembly, crimp connection, angled, rotatable, axial seal	1621735	1	1621738	1	1621744	1

Accessories

For crimp connection: crimp contacts	Order separately, see page 105 onwards
Color rings, 50 pcs. in set (to be ordered separately)	See page 180

Crimp contacts

Male and female crimp contacts with various connection cross sections can be ordered for each crimp contact carrier.



Punched-rolled crimp contacts



Turned crimp contacts

ERC

ERC

Description		Ordering data			Ordering data		
		Type	Order No.	Pcs./Pkt.	Type	Order No.	Pcs./Pkt.
Crimp contact for contact carriers, 6-pos., 6 x Ø2.0 mm							
	Male Ø 2.0 mm / 1.0 ... 1.5				RC-5CP2000	1603513	50
	Female Ø 2.0 mm / 1.0 ... 1.5				RC-5CS2000	1603517	50
	Male Ø 2.0 mm / 1.5 ... 2.5				RC-5AP2000	1603505	50
	Female Ø 2.0 mm / 1.5 ... 2.5				RC-5AS2000	1603509	50
Crimp contact for contact carriers, 7-pos., 7 x Ø2.0 mm							
	Male Ø 2.0 mm / 1.0 ... 1.5				RC-5CP2000	1603513	50
	Female Ø 2.0 mm / 1.0 ... 1.5				RC-5CS2000	1603517	50
	Male Ø 2.0 mm / 1.5 ... 2.5				RC-5AP2000	1603505	50
	Female Ø 2.0 mm / 1.5 ... 2.5				RC-5AS2000	1603509	50
Crimp contact for contact carriers, 9-pos. (8+1), 8 x Ø1.0 mm, 1 x Ø2.0 mm							
	Male Ø1.0 mm / 0.14 ... 0.56				RC-12P2000	1597862	100
	Female Ø1.0 mm / 0.14 ... 0.56				RC-12S2000	1599600	100
	Male Ø 2.0 mm / 1.5 ... 2.5				RC-5AP2000	1603505	50
	Female Ø 2.0 mm / 1.5 ... 2.5				RC-5AS2000	1603509	50
	Male Ø 2.0 mm / 1.0 ... 1.5				RC-5CP2000	1603513	50
	Female Ø 2.0 mm / 1.0 ... 1.5				RC-5CS2000	1603517	50
Crimp contact for contact carriers, 12-pos., 12 x Ø 1.0 mm and 17-pos., 17 x Ø 1.0 mm							
	Male Ø 1.0 mm / 0.08 ... 0.22				RC-11P2000	1596770	100
	Female Ø 1.0mm / 0.08 ... 0.22				RC-11S2000	1596772	100
	Male Ø1.0 mm / 0.14 ... 0.56				RC-12P2000	1597862	100
	Female Ø1.0 mm / 0.14 ... 0.56				RC-12S2000	1599600	100
	Male Ø 1.0 mm / 0.5 ... 1.0				RC-1KP2000	1602996	100
	Female Ø 1.0mm / 0.5 ... 1.0				RC-1KS2000	1602998	100
Crimp contact for contact carriers, 12-pos., 12 x Ø 1.0 mm and 17-pos., 17 x Ø 1.0 mm							
	Single contact male Ø 1.0 mm / 0.22 ... 0.56	RC-22P2000	1603321	100			
	Single contact female Ø 1.0 mm / 0.22 ... 0.56	RC-22S2000	1603327	100			
	Roll with 500 pieces, male Ø 1.0 mm / 0.22 ... 0.56	RC-22P2300	1603324	1			
	Roll with 500 pieces, female Ø 1.0 mm / 0.22 ... 0.56	RC-22S2300	1603330	1			
	Roll with 10,000 pieces, male Ø 1.0 mm / 0.22 ... 0.56	RC-22P2400	1603325	1			
	Roll with 10,000 pieces, female Ø 1.0 mm / 0.22 ... 0.56	RC-22S2400	1603332	1			
Crimp contact for contact carriers, 19-pos. (16+2+PE), 16 x Ø1.0 mm, 2 x Ø1.5 mm, 1 x Ø1.5 mm (PE)							
	Male Ø 1.0 mm / 0.08 ... 0.22				RC-15P2010	1623776	100
	Male Ø 1.0 mm / 0.14 ... 0.56				RC-15P2020	1623777	100
	Male Ø 1.0 mm / 0.5 ... 1.0				RC-15P2030	1623778	100
Crimp contact for contact carrier, 19-pos. (16+2+PE), 2 x Ø 1.5 mm							
	Male Ø 1.5 mm / 0.75 ... 1.0				RC-15P2000	1623779	100
	Female Ø 1.5 mm / 0.75 ... 1.0				RC-15S2000	1623775	100
Crimp contact for contact carrier, 19-pos. (16+2+PE), 1 x Ø 1.5 mm							
	Male, leading Ø 1.5 mm / 0.75 ... 1.0				RC-15P2100	1623780	100
		Accessories			Accessories		
Crimping tools		See page 176			See page 176		

Circular connectors

M23 feedback connectors

Mechanical and electrical data

Mechanical data	
Housing material:	Copper zinc alloy (CuZn), die-cast zinc (GD-Zn)
Housing surface:	Nickel-plated / thick layer passivated (can be coated)
Insulating body:	Polyamide (PA 66)
Contact material:	Copper zinc alloy (CuZn)
Contact surface:	Nickel-plated (Ni) with gold coating (Au)
Connection technology:	Crimp connection
Sealing and O-ring:	Fluororubber (FPM)
Ambient temperature:	-20°C ... 125°C
Cable entry:	Cable and coupler connectors for an outer cable diameter of 3 to 14.5 mm, shielded
Type of locking:	M23 SPEEDCON screw locking, cable connector with M23 x 1 coarse-pitch thread as an option
Mechanical insertion cycles:	Standard: 100, punched-rolled C-HC crimp contacts: up to 500
Protection class:	IP67 when locked

Electrical data			
Number of positions		12	17
Contacts		12	17
Contact Ø	[mm]	1	1
Litz wire cross section, crimp contacts turned	[mm ²]	0.08 ... 1.0	0.08 ... 1.0
Litz wire cross section, C-HC crimp contacts punched-rolled	[mm ²]	0.06 ... 0.56	0.06 ... 0.56
Cable clamping area	Max. Ø [mm]	14.5	14.5
Nominal current per contact at 25°C ¹⁾	[A]	8	8
Specifications in accordance with DIN EN 61984:2009			
Rated voltage	[V AC/DC]	150	100
Test/surge voltage	[kV]	2.5	1.5
Overvoltage category		III	III
Pollution degree ²⁾		3	3
Installation altitude	[m]	Up to 3000	Up to 3000
Cable clamping area ³⁾	Max. Ø [mm]	14.5	14.5

¹⁾ Determine the effective current carrying capacity depending on the application, if necessary, using a derating curve.

²⁾ The values specified assume that the connector pair is correctly locked and is only disconnected for testing and maintenance purposes. If the connector is unlocked and exposed to ambient conditions, and if there is a danger of pollution, seal the connector using a protective cap ≥ IP54.

³⁾ The cable clamping areas specified on the following pages may vary depending on the cable material and structure. Selection and testing is the responsibility of the user.

Note:
In contrast to connecting equipment, connectors may only be plugged in / unplugged when the power supply is disconnected.

Contact chamber numbering (view of plug-in side)				
Direction of rotation for contact chamber numbering (view of plug-in side)				
	Forward running (standard) R marked	Reverse running (standard) L marked	Reverse running (counter direction) L marked	Forward running (counter direction) R marked
Number of positions	Male	Female	Male	Female
12-pos. N-coding Crimp				
17-pos. N-coding Crimp				

Note:

The standard coding is "N". Other codings and numbers of positions available on request.

The connectors can be assembled with male or female contacts depending on the application.

For safety reasons, only use female contacts in the live part of the connector.

Circular connectors

M23 feedback connectors

Selection guide

M23 feedback connectors

12- and 17-pos., N-coding, up to 8 A / 150 V, crimp ranges up to 1 mm²

- Cable connectors
- Coupler connectors
- Device connectors (device flanges)

Crimp contacts must be ordered separately depending on the connection cross section.

Every housing type can be assembled with male or female contacts.

The connectors are available with forward or reverse running contact chamber numbering.

N (0°) and S (20°, on request) coding positions are possible.

The product chart provides an overview of the available components.

Connector type

Cable connectors

SPEEDCON fast locking system, see page 110.

M23 x 1 standard locking, see page 110.

Shielded



Square mounting flange for cable and coupler connectors for wall mounting, see page 179.

Coupler connectors

See page 111.

Shielded



Square mounting flange for cable and coupler connectors for wall mounting, see page 179.

Device connectors

Straight, 4-hole mounting
Ø 3.2, see page 112.



Contact carrier for snapping in from the device side, straight, 4-hole mounting Ø 3.2, see page 112.



Shielded

Angled, rotatable, flange dimensions: 26 mm x 26 mm, see page 112.



Angled, rotatable, flange dimensions: 28 mm x 28 mm, see page 112.



Crimp contacts

Female contacts

Turned, see page 113.



Tools/accessories

Crimping tools

Crimping pliers with digital display for turned crimp contacts, see page 177.



All housings can be fitted with male or female crimp contacts

Male contacts

Turned, see page 113.



Tools/accessories

Unlocking tool for device connectors with contact carriers for snapping in from the device side, see page 179.



Color rings for individually marking the connectors, see page 180.

**Note:**

For safety reasons, only use female contacts in the live part of the connector.

Circular connectors

M23 feedback connectors

Cable connectors, SPEEDCON fast locking system

- 12- and 17-pos. versions
- Individual marking of connectors with color rings



Cable connector, female assembly



Cable connector, male assembly

Description	Cable clamping area	Ordering data				Ordering data			
		Order No.	Pcs./Pkt.	Order No.	Pcs./Pkt.	Order No.	Pcs./Pkt.	Order No.	Pcs./Pkt.
		12-pos.		17-pos.		12-pos.		17-pos.	
Cable connector, with contact carrier, without contacts, standard direction of rotation									
Universal gasket	3 mm ... 14.5 mm	1619472	1	1619470	1	1619471	1	1619469	1
	4 mm ... 6 mm	1619466	1	1619464	1	1619465	1	1619463	1
	6 mm ... 10 mm	1619460	1	1619458	1	1619459	1	1619457	1
	10 mm ... 14.5 mm	1619454	1	1619452	1	1619453	1	1619451	1
Cable connector, with contact carrier, without contacts, direction reverse of rotation									
Universal gasket	3 mm ... 14.5 mm	1619474	1			1619473	1		
	4 mm ... 6 mm	1619468	1			1619467	1		
	6 mm ... 10 mm	1619462	1			1619461	1		
	10 mm ... 14.5 mm	1619456	1			1619455	1		
Accessories									
Crimp contacts		For female contacts, see page 113 onwards				For male contacts, see page 113 onwards			
Color rings, 50 pcs. in set (to be ordered separately)		See page 180				See page 180			

Cable connectors, M23 standard locking

- M23 standard knurled nut
- 12- and 17-pos. versions
- Individual marking of connectors with color rings



Cable connector, female assembly



Cable connector, male assembly

Description	Cable clamping area	Ordering data				Ordering data			
		Order No.	Pcs./Pkt.	Order No.	Pcs./Pkt.	Order No.	Pcs./Pkt.	Order No.	Pcs./Pkt.
		12-pos.		17-pos.		12-pos.		17-pos.	
Cable connector housing, with contact carrier, without contacts, standard direction of rotation									
Universal gasket	3 mm ... 14.5 mm	1619631	1	1619629	1	1619630	1	1619628	1
	4 mm ... 6 mm	1619625	1	1619623	1	1619624	1	1619619	1
	6 mm ... 10 mm	1619616	1	1619614	1	1619615	1	1619613	1
	10 mm ... 14.5 mm	1619610	1	1619608	1	1619609	1	1619607	1
Cable connector housing, with contact carrier, without contacts, reverse direction of rotation									
Universal gasket	3 mm ... 14.5 mm	1619633	1			1619632	1		
	4 mm ... 6 mm	1619627	1			1619626	1		
	6 mm ... 10 mm	1619618	1			1619617	1		
	10 mm ... 14.5 mm	1619612	1			1619611	1		
Accessories									
Crimp contacts		For female contacts, see page 113 onwards				For male contacts, see page 113 onwards			
Color rings, 50 pcs. in set (to be ordered separately)		See page 180				See page 180			

Coupler connectors

- Compatible with mating connectors with SPEEDCON and M23 standard knurled nut
- 12- and 17-pos. versions
- Individual marking of connectors with color rings



Coupler connector, female assembly



Coupler connector, male assembly

Ordering data

Ordering data

Description	Cable clamping area
-------------	---------------------

Order No.	Pcs./Pkt.	Order No.	Pcs./Pkt.

Order No.	Pcs./Pkt.	Order No.	Pcs./Pkt.

Coupler connector housing, with contact carrier, without contacts, standard direction of rotation

Universal gasket	3 mm ... 14.5 mm
	4 mm ... 6 mm
	6 mm ... 10 mm
	10 mm ... 14.5 mm

1620016	1	1620014	1
1620009	1	1620007	1
1620003	1	1620001	1
1619997	1	1619995	1

1620015	1	1620013	1
1620008	1	1620006	1
1620002	1	1620000	1
1619996	1	1619994	1

Coupler connector housing, with contact carrier, without contacts, reverse direction of rotation

Universal gasket	3 mm ... 14.5 mm
	4 mm ... 6 mm
	6 mm ... 10 mm
	10 mm ... 14.5 mm

1620018	1		
1620011	1		
1620005	1		
1619999	1		

1620017	1		
1620010	1		
1620004	1		
1619998	1		

Accessories

Accessories

Crimp contacts
Color rings, 50 pcs. in set (to be ordered separately)

For female contacts, see page 113 onwards
See page 180

For male contacts, see page 113 onwards
See page 180

Circular connectors

M23 feedback connectors

Device connectors, straight, front mounting

- Compatible with mating connectors with SPEEDCON and M23 standard knurled nut
- Contact insert for support on the device or can be snapped in



Device connector, straight, female assembly



Device connector, straight, male assembly

Description	Ordering data				Ordering data			
	Order No.	Pcs./Pkt.	Order No.	Pcs./Pkt.	Order No.	Pcs./Pkt.	Order No.	Pcs./Pkt.
Device connector, straight , with contact carrier, without contacts, 4-hole fastening with \varnothing 3.2 mm								
Standard direction of rotation	1607283	1	1607892	1	1607236	1	1607860	1
Reverse direction of rotation	1607307	1			1607260	1		
Device connector, straight , with contact carrier, without contacts, 4-hole fastening with \varnothing 3.2 mm, contact insert can be snapped in								
Standard direction of rotation	1607830	1	1607893	1	1607804	1	1607863	1
Reverse direction of rotation	1607844	1			1607817	1		
Accessories				Accessories				
Crimp contacts	For female contacts, see page 113 onwards				For male contacts, see page 113 onwards			
Color rings, 50 pcs. in set (to be ordered separately)	See page 180				See page 180			
Protective caps (to be ordered separately)	See page 181				See page 181			

Device connectors, angled, rotatable, front mounting

- Compatible with mating connectors with SPEEDCON and M23 standard knurled nut
- Flange dimensions: 26 mm x 26 mm or 28 mm x 28 mm



Device connectors, angled, rotatable, female assembly



Device connectors, angled, rotatable, male assembly

Description	Ordering data				Ordering data			
	Order No.	Pcs./Pkt.	Order No.	Pcs./Pkt.	Order No.	Pcs./Pkt.	Order No.	Pcs./Pkt.
Device connector, angled, rotatable , with contact carrier, without contacts, flange dimensions: 26 mm x 26 mm								
Standard direction of rotation	1607280	1	1607345	1	1607233	16	1607328	1
Reverse direction of rotation	1607304	1			1607257	1		
Device connector, angled, rotatable , with contact carrier, without contacts, flange dimensions: 28 mm x 28 mm								
Standard direction of rotation	1607827	1	1607887	1	1607802	1	1607852	1
Reverse direction of rotation	1607842	1			1607814	1		
Accessories				Accessories				
Crimp contacts	For female contacts, see page 113 onwards				For male contacts, see page 113 onwards			
Color rings, 50 pcs. in set (to be ordered separately)	See page 180				See page 180			
Protective caps (to be ordered separately)	See page 181				See page 181			

Crimp contacts, turned

Depending on the number of positions, assemble the M23 feedback connectors with 12 or 17 \varnothing 1 mm signal contacts from the SF series.

These contacts are also used as signal contacts with the M23 power connectors. This simplifies handling and storage considerably.

Note: Depending on the litz wire used, the connection cross sections (crimp ranges) can differ from the values listed below.



Crimp contacts, female



Crimp contacts, male

		Ordering data			Ordering data		
Description	Connection cross section [mm ²]	Type	Order No.	Pcs./Pkt.	Type	Order No.	Pcs./Pkt.
Contact female \varnothing 1.0 mm	0.06 ... 0.2	SF-6CS2000	1605562	100			
	0.14 ... 0.5	SF-10KS004	1607356	100			
	0.5 ... 1.0	SF-6AS2000	1605557	100			
Contact male \varnothing 1.0 mm	0.06 ... 0.2				SF-6CP2000	1605559	100
	0.14 ... 0.5				SF-10KP004	1607355	100
	0.5 ... 1.0				SF-6AP2000	1605554	100
		Accessories			Accessories		
Crimping tools		Order separately, see page 177			Order separately, see page 177		

Notes:

Each connector housing type can be assembled with male or female contacts.

For safety reasons, only use male contacts in the live part of the connector.

Mechanical and electrical data

Mechanical data

Housing material:	Copper zinc alloy (CuZn), die-cast zinc (GD-Zn)
Housing surface:	Nickel-plated / thick layer passivated (can be coated)
Insulating body:	Polyamide (PA 66)
Contact material:	Copper zinc alloy (CuZn)
Contact surface:	Nickel-plated (Ni) with gold coating (Au)
Connection technology:	Crimp connection
Sealing and O-ring:	Fluororubber (FPM)
Ambient temperature:	-40°C ... 130°C
Cable entry:	Cable and coupler connectors for an outer cable diameter of 7.5 to 18 mm, shielded
Type of locking:	M23 SPEEDCON screw locking
Mechanical insertion cycles:	Standard: 100
Protection class:	IP67 when locked

Electrical data

Number of positions		13 (4 + 4 + 4 + PE), CAT5 (100 Mbps)				13 (8 + 4 + PE)							
Contacts		4	+	4	+	4	+	PE	8	+	4	+	PE
Contact Ø	[mm]	0.8		1.0		2.0		2.0	1.0		2.0		2.0
Litz wire cross sections													
Cable and coupler connectors:													
	Cable Ø max. 18 mm	[mm ²]	0.08 ... 0.5	0.06 ... 1.0	0.25 ... 4.0	0.25 ... 4.0	0.06 ... 1.0	0.25 ... 4.0	0.25 ... 4.0				
Device connectors:		[mm ²]	0.08 ... 0.5	0.06 ... 1.0	0.25 ... 4.0	0.25 ... 4.0	0.06 ... 1.0	0.25 ... 4.0	0.25 ... 4.0				
Nominal current per contact at 25°C ¹⁾		[A]	3.6	8	30	-	8	30	-				
Specifications in accordance with DIN EN 61984:2009													
Rated voltage		[V AC/DC]	50/50	50/50	630/850	-	50/50	630/850	-				
Test/surge voltage		[kV AC]	1.5	1.5	6	-	1.5	6	-				
Overvoltage category		[AC/DC]		III/II		-		III/II					
Pollution degree ²⁾					3			3					
Cable clamping area ³⁾		Max. Ø [mm]			18			18					

¹⁾ Determine the effective current carrying capacity depending on the application, if necessary, using a derating curve.

²⁾ The values specified assume that the connector pair is correctly locked and is only disconnected for testing and maintenance purposes. If the connector is unlocked and exposed to ambient conditions, and if there is a danger of pollution, seal the connector using a protective cap ≥ IP54.

³⁾ The cable clamping areas specified on the following pages may vary depending on the cable material and structure. Selection and testing is the responsibility of the user.

Contact chamber numbering (view of plug-in side)				
Number of positions	Male		Female	
13-pos., CAT5 (100 Mbps) (4 + 4 + 4 + PE) Crimp				
13-pos. (8 + 4 + PE) Crimp				

Circular connectors

M23 hybrid connectors

Selection guide

M23 hybrid connectors up to 30 A/630 V AC/850 V DC, crimp ranges up to 4 mm²

- Cable connectors
- Coupler connectors
- Device connectors (device flanges)

The connectors are pre-assembled on delivery. The connectors can be furnished with the corresponding crimp contacts.

The product chart provides an overview of the available components.

Connector type

Cable connectors

SPEEDCON fast locking system, see page 118.

M23 x 1 standard interlocking, see page 118.



Shielded

Coupler connectors

See page 119.

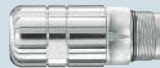

Shielded

Device connectors

Straight, front mounting see page 119.



Straight, rear mounting see page 120.

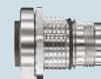

Angled, rotatable, flange dimensions: 26 mm x 26 mm, see page 120.



Angled, rotatable, flange dimensions: 28 mm x 28 mm see page 120.



Shielded

Crimp contacts

Female contacts

Turned, see page 121.



All housings can be fitted with male or female crimp contacts

Male contacts

Turned, see page 121.



Tools/accessories

Crimping pliers with digital display for turned crimp contacts, see page 177.



Accessories

Color rings for individually marking the connectors, see page 180.

**Note:**

For safety reasons, only use female contacts in the live part of the connector.

Circular connectors

M23 hybrid connectors

Cable connectors, hybrid, SPEEDCON fast locking system

- 4x power+PE, 4x signal, 4x data (CAT5, 100 Mbps)
- 4x power+PE, 8x signal



Cable connector, female assembly



Cable connector, male assembly

Description	Cable clamping area
-------------	---------------------

Cable connector, with contact carrier, without contacts, crimp connection

Universal gasket	7.5 mm ... 18 mm
	7.5 mm ... 9 mm
	9 mm ... 12 mm
	12 mm ... 15 mm
	15 mm ... 18 mm

Ordering data			
Order No.	Pcs./Pkt.	Order No.	Pcs./Pkt.
4 x signal + CAT5		8 x signal	

1621517	1	1621524	1
1621520	1	1621525	1
1621521	1	1621526	1
1621522	1	1621527	1
1621523	1	1621528	1

Ordering data			
Order No.	Pcs./Pkt.	Order No.	Pcs./Pkt.
4 x signal + CAT5		8 x signal	

1621529	1	1621534	1
1621530	1	1621535	1
1621531	1	1621536	1
1621532	1	1621537	1
1621533	1	1621538	1

M23 hybrid cable, (5 x 2.5 + 2 x (2 x 0.5) + (4 x 22 AWG)C)C

Length of cable: 1 m
Length of cable: 20 m
Length of cable: 100 m

Crimp contacts
Color rings, 50 pcs. in set (to be ordered separately)
Protective caps (to be ordered separately)

Accessories			
KC-88014311/1,00	1623127	1	
KC-88014311/20,00	1622080	1	
KC-88014311/100,00	1623039	1	

See page 121
See page 180
See page 181

Accessories			
KC-88014311/1,00	1623127	1	
KC-88014311/20,00	1622080	1	
KC-88014311/100,00	1623039	1	

See page 121
See page 180
See page 181

Cable connectors, hybrid, standard locking

- 4x power+PE, 4x signal, 4x data (CAT5, 100 Mbps)
- 4x power+PE, 8x signal



Cable connector, female assembly



Cable connector, male assembly

Description	Cable clamping area
-------------	---------------------

Cable connector, with contact carrier, without contacts, crimp connection

Universal gasket	7.5 mm ... 18 mm
	7.5 mm ... 9 mm
	9 mm ... 12 mm
	12 mm ... 15 mm
	15 mm ... 18 mm

Ordering data			
Order No.	Pcs./Pkt.	Order No.	Pcs./Pkt.
4 x signal + CAT5		8 x signal	

1621997	1	1622002	1
1621998	1	1622003	1
1621999	1	1622004	1
1622000	1	1622005	1
1622001	1	1622006	1

Ordering data			
Order No.	Pcs./Pkt.	Order No.	Pcs./Pkt.
4 x signal + CAT5		8 x signal	

1622007	1	1622012	1
1622008	1	1622013	1
1622009	1	1622014	1
1622010	1	1622015	1
1622011	1	1622016	1

M23 hybrid cable, (5 x 2.5 + 2 x (2 x 0.5) + (4 x 22 AWG)C)C

Length of cable: 1 m
Length of cable: 20 m
Length of cable: 100 m

Crimp contacts
Color rings, 50 pcs. in set (to be ordered separately)
Protective caps (to be ordered separately)

Accessories			
KC-88014311/1,00	1623127	1	
KC-88014311/20,00	1622080	1	
KC-88014311/100,00	1623039	1	

See page 121
See page 180
See page 181

Accessories			
KC-88014311/1,00	1623127	1	
KC-88014311/20,00	1622080	1	
KC-88014311/100,00	1623039	1	

See page 121
See page 180
See page 181

Coupler connectors, hybrid

- Compatible with mating connectors with SPEEDCON and M23 standard knurled nut
- 4x power+PE, 4x signal, 4x data (CAT5, 100 Mbps)
- 4x power+PE, 8x signal



Coupler connector, female assembly



Coupler connector, male assembly

Ordering data			
Order No.	Pcs./Pkt.	Order No.	Pcs./Pkt.
4 x signal + CAT5		8 x signal	

Ordering data			
Order No.	Pcs./Pkt.	Order No.	Pcs./Pkt.
4 x signal + CAT5		8 x signal	

Description	Cable clamping area
Coupler connector , with contact carrier, without contacts, crimp connection	
Universal gasket	7.5 mm ... 18 mm
	7.5 mm ... 9 mm
	9 mm ... 12 mm
	12 mm ... 15 mm
	15 mm ... 18 mm

Accessories			
KC-88014311/1,00	1623127	1	
KC-88014311/20,00	1622080	1	
KC-88014311/100,00	1623039	1	

Accessories			
KC-88014311/1,00	1623127	1	
KC-88014311/20,00	1622080	1	
KC-88014311/100,00	1623039	1	

M23 hybrid cable , (5 x 2.5 + 2 x (2 x 0.5) + (4 x 22 AWG)C)C
Length of cable: 1 m
Length of cable: 20 m
Length of cable: 100 m
Crimp contacts
Color rings , 50 pcs. in set (to be ordered separately)
Protective caps (to be ordered separately)

See page 121
See page 180
See page 181

See page 121
See page 180
See page 181

Device connectors, hybrid, straight, front mounting

- The external thread is designed for the standard and SPEEDCON fast locking system
- 4x power+PE, 4x signal, 4x data (CAT5, 100 Mbps)
- 4x power+PE, 8x signal



Device connector, straight, female assembly



Device connector, straight, male assembly

Ordering data			
Order No.	Pcs./Pkt.	Order No.	Pcs./Pkt.
4 x signal + CAT5		8 x signal	

Ordering data			
Order No.	Pcs./Pkt.	Order No.	Pcs./Pkt.
4 x signal + CAT5		8 x signal	

Description
Device connector , with contact carrier, without contacts
Flange dimensions: 26 mm x 26 mm

Accessories			
See page 121			
See page 180			
See page 181			

Accessories			
See page 121			
See page 180			
See page 181			

Crimp contacts
Color rings , 50 pcs. in set (to be ordered separately)
Protective caps (to be ordered separately)

Circular connectors

M23 hybrid connectors

Device connectors, hybrid, straight, rear mounting

- Compatible with mating connectors with SPEEDCON and M23 standard knurled nut
- 4x power+PE, 4x signal, 4x data (CAT5, 100 Mbps)
- 4x power+PE, 8x signal



Device connector, straight, female assembly



Device connector, straight, male assembly

Description	Ordering data				Ordering data			
	Order No.	Pcs./Pkt.	Order No.	Pcs./Pkt.	Order No.	Pcs./Pkt.	Order No.	Pcs./Pkt.
Device connector, with contact carrier, without contacts	4 x signal + CAT5		8 x signal		4 x signal + CAT5		8 x signal	
	1624344	1	1627204	1	1627205	1	1627206	1
Accessories		Accessories		Accessories		Accessories		
Crimp contacts	See page 121		See page 121		See page 121		See page 121	
Color rings, 50 pcs. in set (to be ordered separately)	See page 180		See page 180		See page 180		See page 180	
Protective caps (to be ordered separately)	See page 181		See page 181		See page 181		See page 181	

Device connectors, hybrid, angled, rotatable, front mounting

- The external thread is designed for the standard and SPEEDCON fast locking system
- 4x power+PE, 4x signal, 4x data (CAT5, 100 Mbps)
- 4x power+PE, 8x signal
- Housing can be freely rotated by 310°



Device connector, angled, rotatable, female assembly



Device connector, angled, rotatable, male assembly

Description	Ordering data				Ordering data			
	Order No.	Pcs./Pkt.	Order No.	Pcs./Pkt.	Order No.	Pcs./Pkt.	Order No.	Pcs./Pkt.
Device connector, with contact carrier, without contacts	4 x signal + CAT5		8 x signal		4 x signal + CAT5		8 x signal	
Flange dimensions: 26 mm x 26 mm	1621563	1	1621564	1	1621565	1	1621566	1
Device connector, with contact carrier, without contacts	4 x signal + CAT5		8 x signal		4 x signal + CAT5		8 x signal	
Flange dimensions: 28 mm x 28 mm	1621559	1	1621560	1	1621561	1	1621562	1
Accessories		Accessories		Accessories		Accessories		
Crimp contacts	See page 121		See page 121		See page 121		See page 121	
Color rings, 50 pcs. in set (to be ordered separately)	See page 180		See page 180		See page 180		See page 180	
Protective caps (to be ordered separately)	See page 181		See page 181		See page 181		See page 181	

Crimp contacts, turned



Crimp contacts, female



Crimp contacts, male

Description	Connection cross section [mm ²]	Ordering data			Ordering data		
		Type	Order No.	Pcs./Pkt.	Type	Order No.	Pcs./Pkt.
Contact, Ø 0.8 mm	0.08 ... 0.25	SF-08KS010	1621571	100	SF-08KP010	1621574	100
	0.34 ... 0.50	SF-08KS020	1621573	100	SF-08KP020	1621575	100
Contact, Ø 1.0 mm, for signal	0.06 ... 0.25	ST-10KS010	1618239	100	ST-10KP010	1618255	100
	0.34 ... 0.50	ST-10KS020	1618251	100	ST-10KP020	1618256	100
	0.25 ... 1.0	ST-10KS035	1618464	100	ST-10KP035	1618458	100
Contact, Ø 2.0 mm	0.25 ... 1.0	SF-20KS021	1621576	50	SF-20KP021	1621579	50
	1.0 ... 2.5	SF-20KS022	1621577	50	SF-20KP022	1621580	50
	2.5 ... 4.0	SF-20KS023	1621578	50	SF-20KP023	1621581	50

Mechanical and electrical data

Mechanical data

Housing material:	Copper zinc alloy (CuZn), die-cast zinc (GD-Zn)
Housing surface:	Nickel-plated / thick layer passivated (can be coated)
Insulating body:	Polyamide (PA 66)
Contact material:	Copper zinc alloy (CuZn)
Contact surface:	Nickel-plated (Ni) with gold coating (Au)
Connection technology:	Crimp connection
Sealing and O-ring:	Fluororubber (FPM)
Ambient temperature:	-40°C ... 130°C
Cable entry:	Cable and coupler connectors for an outer cable diameter of 9 to 26.5 mm, shielded
Type of locking:	M40 SPEEDCON screw locking
Mechanical insertion cycles:	Standard: 100
Protection class:	IP68/IP69K when locked

Electrical data

Number of positions	13 (4 + 4 + 4 + PE), CAT5 (100 Mbps)				13 (4 + 4 + 4 + PE), signal									
Contacts	4	+	4	+	4	+	PE	4	+	4	+	4	+	PE
Contact Ø	[mm]	0.8	1.0	3.6	3.6	1.0	1.0	3.6	3.6					
Litz wire cross sections														
Cable and coupler connectors:														
	Cable Ø max. 26.5 mm	[mm ²]	0.08 ... 0.5	0.06 ... 1.5	2.5 ... 16.0	2.5 ... 16.0	0.06 ... 1.0	0.06 ... 1.5	2.5 ... 16.0	2.5 ... 16.0				
Device connectors:														
		[mm ²]	0.08 ... 0.5	0.06 ... 1.5	2.5 ... 10.0	2.5 ... 10.0	0.06 ... 1.0	0.06 ... 1.5	2.5 ... 10.0	2.5 ... 10.0				
Nominal current per contact at 25°C ¹⁾														
		[A]	3.6	8	70	–	8	8	70	–				
Specifications in accordance with DIN EN 61984:2009														
Rated voltage														
		[V AC/DC]	50/50	500/500	630/850	–	50/50	500/500	630/850	–				
Test/surge voltage														
		[kV AC]	1.5	4	6	–	1.5	4	6	–				
Overvoltage category														
		[AC/DC]	III/II				III/II							
Pollution degree ²⁾														
			3				3							
Installation altitude														
		[m]	Up to 3000				Up to 3000							
Cable clamping area ³⁾														
	Max. Ø	[mm]	26.5				26.5							

¹⁾ Determine the effective current carrying capacity depending on the application, if necessary, using a derating curve.

²⁾ The values specified assume that the connector pair is correctly locked and is only disconnected for testing and maintenance purposes. If the connector is unlocked and exposed to ambient conditions, and if there is a danger of pollution, seal the connector using a protective cap ≥ IP54.

³⁾ The cable clamping areas specified on the following pages may vary depending on the cable material and structure. Selection and testing is the responsibility of the user.

Contact chamber numbering
(view of plug-in side)

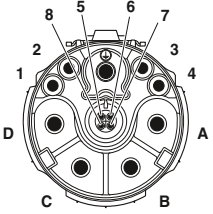
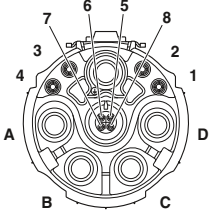
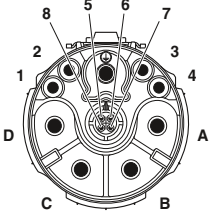
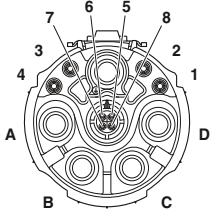
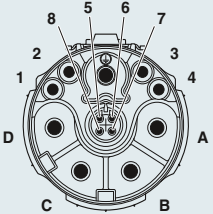
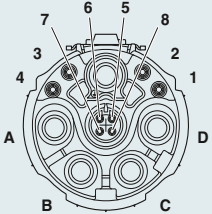
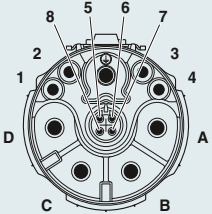
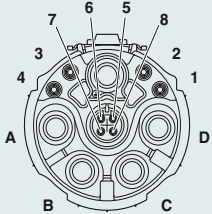
Number of positions	Male AC-coded	Female AC-coded	Male DC-coded	Female DC-coded
<p>13-pos., CAT5 (100 Mbps) (4 + 4 + 4 + PE) Crimp</p>				
<p>13-pos., signal (4 + 4 + 4 + PE) Crimp</p>				

Circular connectors

M40 hybrid connectors

Selection guide

M40 hybrid connectors up to
70 A/630 V AC/850 V DC,
crimp ranges up to 16 mm²

- Cable connectors
- Coupler connectors
- Device connectors (device flanges)

The connectors are pre-assembled on
delivery. The connectors can be furnished
with the corresponding crimp contacts.

The product chart provides an overview
of the available components.

Connector type

Cable connectors

SPEEDCON fast locking system,
see page 126.



Shielded

Coupler connectors

See page 127.



Shielded

Device connectors

Straight,
see page 128.



Angled, rotatable,
see page 128.



Shielded

Crimp contacts

Female contacts

Turned, see page 129.



All housings can be fitted with male or female crimp contacts

Male contacts

Turned, see page 129.



Tools/accessories

Crimping pliers with digital display for turned crimp contacts, see page 177.



Accessories

Color rings for individually marking the connectors, see page 180.

**Note:**

For safety reasons, only use female contacts in the live part of the connector.

Circular connectors

M40 hybrid connectors

Cable connectors, hybrid, SPEEDCON fast locking system

- 4x power+PE, 4x signal, 4x data (CAT5, 100 Mbps)
- 4x power+PE, 8x signal



Cable connector, female assembly



Cable connector, male assembly

Description		Ordering data		Ordering data		Ordering data		Ordering data	
		Order No.	Pcs./Pkt.	Order No.	Pcs./Pkt.	Order No.	Pcs./Pkt.	Order No.	Pcs./Pkt.
Cable clamping area		4+4+4+PE-pos. (CAT5)		4+4+4+PE-pos. (signal)		4+4+4+PE-pos. (CAT5)		4+4+4+PE-pos. (signal)	
Cable connector, AC-coded, with contact carrier, without contacts, crimp connection									
Universal gasket	9 mm ... 14 mm	1623324	1	1623329	1	1623332	1	1623335	1
	14 mm ... 20.5 mm	1623327	1	1623330	1	1623333	1	1623336	1
	20.5 mm ... 26.5 mm	1623328	1	1623331	1	1623334	1	1623337	1
Cable connector, DC-coded, with contact carrier, without contacts, crimp connection									
Universal gasket	9 mm ... 14 mm	1623683	1	1623686	1	1623692	1	1623695	1
	14 mm ... 20.5 mm	1623684	1	1623687	1	1623693	1	1623696	1
	20.5 mm ... 26.5 mm	1623685	1	1623688	1	1623694	1	1623697	1
M40 hybrid cable, (5 x 10 + 2 x (2 x 0.5) + (4 x 22 AWG)C)C									
Length of cable: 1 m		KC-88014448/1,00		1627298	1	KC-88014448/1,00		1627298	1
Length of cable: 20 m		KC-88014448/20,00		1627299	1	KC-88014448/20,00		1627299	1
Crimp contacts		see page 129				see page 129			
Color rings, 50 pcs. in set (to be ordered separately)		See page 180				See page 180			
Protective caps (to be ordered separately)		See page 181				See page 181			

Coupler connectors, hybrid, M40 standard locking

- Compatible with mating connectors with SPEEDCON and M40 standard knurled nut
- 4x power+PE, 4x signal, 4x data (CAT5, 100 Mbps)
- 4x power+PE, 8x signal



Coupler connector, female assembly



Coupler connector, male assembly

		Ordering data				Ordering data			
Description	Cable clamping area	Order No.	Pcs./Pkt.	Order No.	Pcs./Pkt.	Order No.	Pcs./Pkt.	Order No.	Pcs./Pkt.
		4+4+4+PE-pos. (CAT5)		4+4+4+PE-pos. (signal)		4+4+4+PE-pos. (CAT5)		4+4+4+PE-pos. (signal)	
Coupler connector, AC-coded, with contact carrier, without contacts, crimp connection									
Universal gasket	9 mm ... 14 mm	1623339	1	1623344	1	1623356	1	1623359	1
	14 mm ... 20.5 mm	1623341	1	1623345	1	1623357	1	1623360	1
	20.5 mm ... 26.5 mm	1623342	1	1623346	1	1623358	1	1623361	1
Coupler connector, DC-coded, with contact carrier, without contacts, crimp connection									
Universal gasket	9 mm ... 14 mm	1623701	1	1623704	1	1623710	1	1623713	1
	14 mm ... 20.5 mm	1623702	1	1623705	1	1623711	1	1623714	1
	20.5 mm ... 26.5 mm	1623703	1	1623706	1	1623712	1	1623715	1
		Accessories				Accessories			
M40 hybrid cable, (5 x 10 + 2 x (2 x 0.5) + (4 x 22 AWG)C)C									
Length of cable: 1 m		KC-88014448/1,00		1627298	1	KC-88014448/1,00		1627298	1
Length of cable: 20 m		KC-88014448/20,00		1627299	1	KC-88014448/20,00		1627299	1
Crimp contacts		see page 129				see page 129			
Color rings, 50 pcs. in set (to be ordered separately)		See page 180				See page 180			
Protective caps (to be ordered separately)		See page 181				See page 181			

Circular connectors

M40 hybrid connectors

Device connectors, hybrid, straight, front mounting

- The external thread is designed for the standard and SPEEDCON fast locking system
- 4x power+PE, 4x signal, 4x data (CAT5, 100 Mbps)
- 4x power+PE, 8x signal



Device connector, straight, female assembly



Device connector, straight, male assembly

Description	Ordering data				Ordering data			
	Order No.	Pcs./Pkt.	Order No.	Pcs./Pkt.	Order No.	Pcs./Pkt.	Order No.	Pcs./Pkt.
Device connector, AC-coded, with contact carrier, without contacts, crimp connection	4+4+4+PE-pos. (CAT5)		4+4+4+PE-pos. (signal)		4+4+4+PE-pos. (CAT5)		4+4+4+PE-pos. (signal)	
Flange dimensions: 40 mm x 40 mm	1623371	1	1623372	1	1623374	1	1623375	1
Device connector, DC-coded, with contact carrier, without contacts, crimp connection								
Flange dimensions: 40 mm x 40 mm	1623725	1	1623726	1	1623728	1	1623729	1
Accessories				Accessories				
Crimp contacts	see page 129			see page 129				
Color rings, 50 pcs. in set (to be ordered separately)	See page 180			See page 180				
Protective caps (to be ordered separately)	See page 181			See page 181				

Device connectors, hybrid, angled, rotatable, front mounting

- The external thread is designed for the standard and SPEEDCON fast locking system
- 4x power+PE, 4x signal, 4x data (CAT5, 100 Mbps)
- 4x power+PE, 8x signal



Device connector, angled, rotatable, female assembly



Device connector, angled, rotatable, male assembly

Description	Ordering data				Ordering data			
	Order No.	Pcs./Pkt.	Order No.	Pcs./Pkt.	Order No.	Pcs./Pkt.	Order No.	Pcs./Pkt.
Device connector, AC-coded, angled, rotatable, with contact carrier, without contacts, crimp connection	4+4+4+PE-pos. (CAT5)		4+4+4+PE-pos. (signal)		4+4+4+PE-pos. (CAT5)		4+4+4+PE-pos. (signal)	
Flange dimensions: 40 mm x 40 mm	1623365	1	1623366	1	1623368	1	1623369	1
Device connector, DC-coded, angled, rotatable, with contact carrier, without contacts, crimp connection								
Flange dimensions: 40 mm x 40 mm	1623719	1	1623720	1	1623722	1	1623723	1
Accessories				Accessories				
Crimp contacts	see page 129			see page 129				
Color rings, 50 pcs. in set (to be ordered separately)	See page 180			See page 180				
Protective caps (to be ordered separately)	See page 181			See page 181				

Crimp contacts, turned

Notes:

1) Not for device connector, angled, rotatable



Crimp contacts, female



Crimp contacts, male

Description	Connection cross section [mm ²]	Ordering data			Ordering data		
		Type	Order No.	Pcs./Pkt.	Type	Order No.	Pcs./Pkt.
Contact, Ø 0.8 mm	0.08 ... 0.25	SF-08KS010	1621571	100	SF-08KP010	1621574	100
	0.34 ... 0.50	SF-08KS020	1621573	100	SF-08KP020	1621575	100
Contact, Ø 1.0 mm, for CAT5 and signal	0.06 ... 0.25	SB-10KS001	1623603	100	SB-10KP001	1623607	100
	0.34 ... 0.50	SB-10KS002	1623604	100	SB-10KP002	1623611	100
	0.5 ... 1.0	SB-10KS003	1623605	100	SB-10KP003	1623612	100
	1.0 ... 1.5	SB-10KS004	1623606	100	SB-10KP004	1623613	100
Contact, Ø 1.0 mm, for signal	0.06 ... 0.25	ST-10KS010	1618239	100	ST-10KP010	1618255	100
	0.34 ... 0.50	ST-10KS020	1618251	100	ST-10KP020	1618256	100
	0.25 ... 1.0	ST-10KS035	1618464	100	ST-10KP035	1618458	100
Contact, Ø 3.6 mm	2.5 ... 4.0	SB-36KS002	1623378	20	SB-36KP002	1623383	20
	4.0 ... 6.0	SB-36KS003	1623379	20	SB-36KP003	1623384	20
	10.0	SB-36KS004	1623380	20	SB-36KP004	1623385	20
	16.0 ¹⁾	SB-36KS005	1623381	20	SB-36KP005	1623386	20

Mechanical and electrical data

Mechanical data	
Housing material:	Copper zinc alloy (CuZn), die-cast zinc (GD-Zn)
Housing surface:	Nickel-plated / thick-layer passivated (can be coated)
Insulating body:	Polyamide (PA 66)
Contact material:	Copper zinc alloy (CuZn)
Contact surface:	Nickel-plated (Ni) with gold coating (Au)
Connection technology:	Crimp connection
Sealing and O-ring:	Fluororubber (FKM)
Ambient temperature:	-40°C to 125°C
Cable entry:	Cable and coupler connectors for an outer cable diameter of 3.5 to 11 mm, shielded (M17 Compact) 5 to 12.5 mm, shielded (M17)
Type of locking:	M17 SPEEDCON fast locking system, cable connector With M17 x 1 coarse-pitch thread as an option
Mechanical insertion cycles:	Standard: 100, punched-rolled C-HC crimp contacts: up to 500
Protection class:	IP67 when locked

Electrical data		4 (3+PE)	6 (5+PE)	7 (6+PE)	8 (7+PE)	9 (5+3+PE)				
Number of positions		3 + PE	5 + PE	6 + PE	7 + PE	5	+	3	+	PE
Contacts		2	1	1	1	0.6		1		1
Contact Ø	[mm]									
Litz wire cross section, crimp contacts Turned	[mm ²]	0.25 ... 2.5	0.06 ... 1.0	0.06 ... 1.0	0.06 ... 1.0	0.06 ... 0.5		0.06 ... 1.0		0.06 ... 1.0
Litz wire cross section, C-HC crimp contacts Punched-rolled	[mm ²]	–	0.08 ... 0.56	0.06 ... 0.56	0.06 ... 0.56	–		–		–
Nominal current per contact at 25°C ¹⁾	[A]	20 (25) ²⁾	14	14	14	3.6		14		–
Specifications in accordance with DIN EN 61984:2009										
Rated voltage	[V AC/DC]	630	630	630	630	60		630		–
Test/surge voltage	[kV AC]	6	6	6	6	1.5		6		–
Overtoltage category		III	III	III	III			III		
Pollution degree ³⁾		3	3	3	3			3		
Installation altitude	[m]	Up to 3000	Up to 3000	Up to 3000	Up to 3000			Up to 3000		
Cable clamping area ⁴⁾	Max. Ø [mm]	12.5	12.5	12.5	12.5			12.5		

¹⁾ Determine the effective current carrying capacity in accordance with the application, if necessary, using a derating curve.

²⁾ 25 A in the case of assignment with 3 x 2.5 mm²

³⁾ The values specified assume that the connector pair is correctly locked and is only disconnected for testing and maintenance purposes. If the connector is unlocked and exposed to ambient conditions, and if there is a danger of pollution, seal the connector using a protective cap ≥ IP54.

⁴⁾ The cable clamping areas specified on the following pages may vary depending on the cable material and structure. Selection and testing is the responsibility of the user.

Contact chamber numbering
(view of plug-in side)

Number of positions	Male	Female
4-pos. (3+PE) Crimp		
6-pos. (5+PE) (contact chambers 2+5 closed) Crimp		
7-pos. (6+PE) Crimp		
8-pos. (7+PE) Crimp		
9-pos. (5+3+PE) Crimp		

* with grounding spring
PE leading

* with grounding spring
PE leading

Note:

The connectors can be assembled with male or female contacts depending on the application.

For safety reasons, only use female contacts in the live part of the connector.

Circular connectors

M17 power connectors

Selection guide

M17 power connectors, 4-, 6-, 7-, 8-, and 9-pos., up to 20 A/630 V, crimp ranges: 0.06 mm² to 2.5 mm²

- Cable connectors
- Coupler connectors
- Device connectors (device flanges)

The connectors are delivered pre-assembled. The connectors can be furnished with the corresponding crimp contacts.

Every housing type can be assembled with male or female contacts. The cable connectors can be equipped with the SPEEDCON fast locking system or with M17 x 1 coarse-pitch thread as an option. The connectors with external thread are fully compatible with standard threads and the SPEEDCON fast locking system.

The product chart provides an overview of the available components.

Connector type

Cable connectors

SPEEDCON fast locking system, M17 Compact, see page 134.



M17, see page 136.



M17 x 1 standard locking, M17, see page 136.

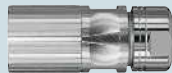

Square mounting flange for cable and coupler connectors for wall mounting, see page 179.



Shielded

Coupler connectors / panel feed-throughs

Coupler connector M17 Compact, see page 134.



M17, see page 137.

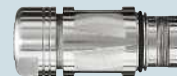

Panel feed-through M17 Compact, see page 135.



Shielded

Device connectors

Straight, M17 Compact, see page 135.



Straight, M17, see page 137.



Straight, with central fastening thread, front mounting, M17, see page 139.

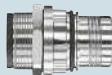

Straight, with central fastening thread, rear mounting, M17, see page 139.

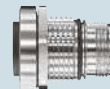

Shielded

Angled, rotatable, M17, see page 138.



Crimp contacts

Female contacts

Turned, see page 140.



All housings can be fitted with male or female crimp contacts

Male contacts

Turned, see page 140.



Tools/accessories

Crimping tools

Crimping pliers with digital display for turned crimp contacts, see page 177.



Tools/accessories

Unlocking tool for device connectors with contact carriers for snapping in from the device side, see page 179.



Color rings for individually marking the connectors, see page 180.

**Note:**

For safety reasons, only use female contacts in the live part of the connector.

Circular connectors

M17 power connectors

Cable connectors, M17 Compact

- High packing density in a compact product
- Individual marking of connectors with color rings



3+PE, 5+PE, 6+PE-pos.



7+PE, 5+3+PE-pos.

Description	Cable clamping area
Cable connector , with contact carrier, without contacts, for female assembly	3.5 mm ... 5.5 mm
	5 mm ... 9.2 mm
	9 mm ... 11.2 mm
Cable connector , with contact carrier, without contacts, for male assembly	3.5 mm ... 5.5 mm
	5 mm ... 9.2 mm
	9 mm ... 11.2 mm

Ordering data					
Order No.	Pcs./Pkt.	Order No.	Pcs./Pkt.	Order No.	Pcs./Pkt.
3+PE-pos.		5+PE-pos.		6+PE-pos.	
1618312	1	1618621	1	1618632	1
1618408	1	1618620	1	1618631	1
1618603	1	1618619	1	1618630	1
1618602	1	1618614	1	1618622	1
1618574	1	1618615	1	1618623	1
1618575	1	1618616	1	1618624	1

Ordering data					
Order No.	Pcs./Pkt.	Order No.	Pcs./Pkt.	Order No.	Pcs./Pkt.
7+PE-pos.		5+3+PE-pos.			
1618633	1	1618674	1		
1618634	1	1618675	1		
1618635	1	1618676	1		
1618640	1	1618681	1		
1618639	1	1618680	1		
1618638	1	1618679	1		

Accessories	
Crimp contacts	Order separately, see page 140 onwards
Color rings, 50 pcs. in set (to be ordered separately)	See page 180
Protective caps (to be ordered separately)	See page 181

Accessories	
Crimp contacts	Order separately, see page 140 onwards
Color rings, 50 pcs. in set (to be ordered separately)	See page 180
Protective caps (to be ordered separately)	See page 181

Accessories	
Crimp contacts	Order separately, see page 140 onwards
Color rings, 50 pcs. in set (to be ordered separately)	See page 180
Protective caps (to be ordered separately)	See page 181

Coupler connectors, M17 Compact

- Compatible with mating connectors with SPEEDCON or M17 standard knurled nuts
- Individual marking of connectors with color rings



3+PE, 5+PE, 6+PE-pos.



7+PE, 5+3+PE-pos.

Description	Cable clamping area
Coupler connector , with contact carrier, without contacts, for female assembly	3.5 mm ... 5.5 mm
	5 mm ... 9.2 mm
	9 mm ... 11.2 mm
Coupler connector , with contact carrier, without contacts, for male assembly	3.5 mm ... 5.5 mm
	5 mm ... 9.2 mm
	9 mm ... 11.2 mm

Ordering data					
Order No.	Pcs./Pkt.	Order No.	Pcs./Pkt.	Order No.	Pcs./Pkt.
3+PE-pos.		5+PE-pos.		6+PE-pos.	
1618695	1	1618696	1	1618708	1
1618694	1	1618697	1	1618709	1
1618693	1	1618698	1	1618710	1
1620614	1	1618703	1	1618704	1
1618406	1	1618702	1	1618705	1
1618690	1	1618701	1	1618706	1

Ordering data					
Order No.	Pcs./Pkt.	Order No.	Pcs./Pkt.	Order No.	Pcs./Pkt.
7+PE-pos.		5+3+PE-pos.			
1618716	1	1618748	1		
1618717	1	1618749	1		
1618718	1	1618750	1		
1618712	1	1618740	1		
1618713	1	1618741	1		
1618714	1	1618742	1		

Accessories	
Crimp contacts	Order separately, see page 140 onwards
Color rings, 50 pcs. in set (to be ordered separately)	See page 180
Protective caps (to be ordered separately)	See page 181

Accessories	
Crimp contacts	Order separately, see page 140 onwards
Color rings, 50 pcs. in set (to be ordered separately)	See page 180
Protective caps (to be ordered separately)	See page 181

Accessories	
Crimp contacts	Order separately, see page 140 onwards
Color rings, 50 pcs. in set (to be ordered separately)	See page 180
Protective caps (to be ordered separately)	See page 181

**Panel feed-throughs,
M17 Compact**

- Panel feed-throughs suitable for front and rear mounting
- Compatible with mating connectors with SPEEDCON or M17 standard knurled nuts
- Individual marking of connectors with color rings
- **Flange dimensions:
25.7 mm x 25.7 mm**



3+PE, 5+PE, 6+PE-pos.



7+PE, 5+3+PE-pos.

Ordering data					
Order No.	Pcs./Pkt.	Order No.	Pcs./Pkt.	Order No.	Pcs./Pkt.
3+PE-pos.		5+PE-pos.		6+PE-pos.	

Ordering data					
Order No.	Pcs./Pkt.	Order No.	Pcs./Pkt.	Order No.	Pcs./Pkt.
7+PE-pos.		5+3+PE-pos.			

Description	Cable clamping area
Panel feed-through, with contact carrier, without contacts, for female assembly	3.5 mm ... 5.5 mm
	5 mm ... 9 mm
	9 mm ... 11 mm
Panel feed-through, with contact carrier, without contacts, for male assembly	3.5 mm ... 5.5 mm
	5 mm ... 9 mm
	9 mm ... 11 mm

Accessories					
Order separately, see page 140 onwards					
See page 180					
See page 181					

Accessories					
Order separately, see page 140 onwards					
See page 180					
See page 181					

Crimp contacts
Color rings, 50 pcs. in set (to be ordered separately)
Protective caps (to be ordered separately)

**Device connectors,
M17 Compact,
front mounting**

- Compatible with mating connectors with SPEEDCON or M17 standard knurled nuts
- Individual marking of connectors with color rings
- **Flange dimensions:
21.6 mm x 21.6 mm**



3+PE, 5+PE, 6+PE-pos.



7+PE, 5+3+PE-pos.



Ordering data					
Order No.	Pcs./Pkt.	Order No.	Pcs./Pkt.	Order No.	Pcs./Pkt.
3+PE-pos.		5+PE-pos.		6+PE-pos.	

Ordering data					
Order No.	Pcs./Pkt.	Order No.	Pcs./Pkt.	Order No.	Pcs./Pkt.
7+PE-pos.		5+3+PE-pos.			

Description
Device connector, with contact carrier, without contacts, for female assembly
Contact insert for support on the device
Device connector, with contact carrier, without contacts, for male assembly
Contact insert for support on the device
Device connector, with contact carrier, without contacts, for female assembly
Contact insert can be snapped in
Device connector, with contact carrier, without contacts, for male assembly
Contact insert can be snapped in

Accessories					
Order separately, see page 140 onwards					
See page 180					
See page 181					
See page 179					

Accessories					
Order separately, see page 140 onwards					
See page 180					
See page 181					
See page 179					

Crimp contacts
Color rings, 50 pcs. in set (to be ordered separately)
Protective caps (to be ordered separately)
Unlocking tool for contact carriers

Circular connectors

M17 power connectors

Cable connectors, SPEEDCON fast locking system

- SPEEDCON fast locking system or M17 standard interlocking
- Standard knurled nut compatible with mating connectors with SPEEDCON and M17 standard external thread
- Individual marking of connectors with color rings



3+PE, 5+PE, 6+PE-pos.



7+PE, 5+3+PE-pos.

Description	Cable clamping area	Ordering data			Ordering data						
		Order No.	Pcs./Pkt.	Order No.	Pcs./Pkt.	Order No.	Pcs./Pkt.	Order No.	Pcs./Pkt.	Order No.	Pcs./Pkt.
Cable connector, with contact carrier, without contacts, for female assembly	5 mm ... 8 mm	1607683	1	1607718	1	1613578	1	1607756	1	1613620	1
	8 mm ... 10 mm	1607685	1	1607720	1	1613580	1	1607759	1	1613622	1
	10 mm ... 12.5 mm	1624538	1	1624544	1	1624550	1	1624556	1	1624639	1
Cable connector, with contact carrier, without contacts, for male assembly	5 mm ... 8 mm	1607665	1	1607700	1	1613559	1	1607736	1	1613601	1
	8 mm ... 10 mm	1607667	1	1607702	1	1613561	1	1607738	1	1613603	1
	10 mm ... 12.5 mm	1624535	1	1624541	1	1624547	1	1624553	1	1624637	1
		Accessories			Accessories						
Crimp contacts		Order separately, see page 140 onwards			Order separately, see page 140 onwards						
Color rings, 50 pcs. in set (to be ordered separately)		See page 180			See page 180						
Protective caps (to be ordered separately)		See page 181			See page 181						

Cable connectors, M17 standard locking

- Standard knurled nut compatible with mating connectors with SPEEDCON and M17 standard external thread
- Individual marking of connectors with color rings



3+PE, 5+PE, 6+PE-pos.



7+PE, 5+3+PE-pos.

Description	Cable clamping area	Ordering data			Ordering data						
		Order No.	Pcs./Pkt.	Order No.	Pcs./Pkt.	Order No.	Pcs./Pkt.	Order No.	Pcs./Pkt.	Order No.	Pcs./Pkt.
Cable connector, with contact carrier, without contacts, for female assembly	5 mm ... 8 mm	1607682	1	1607717	1	1613577	1	1607755	1	1613619	1
	8 mm ... 10 mm	1607684	1	1607719	1	1613579	1	1607758	1	1613621	1
	10 mm ... 12.5 mm	1624537	1	1624543	30	1624549	1	1624555	1	1624638	1
Cable connector, with contact carrier, without contacts, for male assembly	5 mm ... 8 mm	1607663	1	1607699	1	1613558	1	1607735	1	1613600	1
	8 mm ... 10 mm	1607666	1	1607701	1	1613560	1	1607737	1	1613602	1
	10 mm ... 12.5 mm	1624534	1	1624540	1	1624546	1	1624552	1	1624636	1
		Accessories			Accessories						
Crimp contacts		Order separately, see page 140 onwards			Order separately, see page 140 onwards						
Color rings, 50 pcs. in set (to be ordered separately)		See page 180			See page 180						
Protective caps (to be ordered separately)		See page 181			See page 181						

Coupler connectors

- Compatible with mating connectors with SPEEDCON or M17 standard knurled nuts
- Individual marking of connectors with color rings



3+PE, 5+PE, 6+PE-pos.



7+PE, 5+3+PE-pos.

Ordering data					
Order No.	Pcs./Pkt.	Order No.	Pcs./Pkt.	Order No.	Pcs./Pkt.
3+PE-pos.		5+PE-pos.		6+PE-pos.	

Ordering data					
Order No.	Pcs./Pkt.	Order No.	Pcs./Pkt.	Order No.	Pcs./Pkt.
7+PE-pos.		5+3+PE-pos.			

Description	Cable clamping area
Coupler connector , with contact carrier, without contacts, for female assembly	5 mm ... 8 mm
	8 mm ... 10 mm
	10 mm ... 12.5 mm
Coupler connector , with contact carrier, without contacts, for male assembly	5 mm ... 8 mm
	8 mm ... 10 mm
	10 mm ... 12.5 mm

Accessories					
Order separately, see page 140 onwards					
See page 180					
See page 181					

Accessories					
Order separately, see page 140 onwards					
See page 180					
See page 181					

Crimp contacts
Color rings, 50 pcs. in set (to be ordered separately)
Protective caps (to be ordered separately)

Device connectors, straight, front mounting

- Compatible with mating connectors with SPEEDCON or M17 standard knurled nuts
- Contact insert for support on the device or can be snapped in
- Individual marking of connectors with color rings
- **Flange dimensions: 25.7 mm x 25.7 mm**



3+PE, 5+PE, 6+PE-pos.



7+PE, 5+3+PE-pos.

Ordering data					
Order No.	Pcs./Pkt.	Order No.	Pcs./Pkt.	Order No.	Pcs./Pkt.
3+PE-pos.		5+PE-pos.		6+PE-pos.	

Ordering data					
Order No.	Pcs./Pkt.	Order No.	Pcs./Pkt.	Order No.	Pcs./Pkt.
7+PE-pos.		5+3+PE-pos.			

Description
Device connector , with contact carrier, without contacts, for female assembly
Contact insert for support on the device
Device connector , with contact carrier, without contacts, for male assembly
Contact insert for support on the device
Device connector , with contact carrier, without contacts, for female assembly
Contact insert can be snapped in
Device connector , with contact carrier, without contacts, for male assembly
Contact insert can be snapped in

Accessories					
Order separately, see page 140 onwards					
See page 180					
See page 181					
See page 179					

Accessories					
Order separately, see page 140 onwards					
See page 180					
See page 181					
See page 179					

Crimp contacts
Color rings, 50 pcs. in set (to be ordered separately)
Protective caps (to be ordered separately)
Unlocking tool for contact carriers

Circular connectors

M17 power connectors

Device connectors, angled, rotatable, front mounting

- Compatible with mating connectors with SPEEDCON or M17 standard knurled nuts
- Housing can be freely rotated up to 308°
- Individual marking of connectors with color rings
- Flange versions for M2.5 or M3 fixing
- **Flange dimensions: 25.7 mm x 25.7 mm**



3+PE, 5+PE, 6+PE-pos.



7+PE, 5+3+PE-pos.

Description	Ordering data						Ordering data								
	Order No.	Pcs./Pkt.	Order No.	Pcs./Pkt.	Order No.	Pcs./Pkt.	Order No.	Pcs./Pkt.	Order No.	Pcs./Pkt.	Order No.	Pcs./Pkt.			
Device connector, angled, rotatable, with contact carrier, without contacts, for female contacts	3+PE-pos.			5+PE-pos.			6+PE-pos.			7+PE-pos.			5+3+PE-pos.		
Fixing with M2.5 Device connector, angled, rotatable, with contact carrier, without contacts, for male contacts	1620428	1	1620432	1	1620434	1	1620436	1	1620438	1					
Fixing with M2.5 Device connector, angled, rotatable, with contact carrier, without contacts, for female contacts	1620427	1	1620431	1	1620433	1	1620435	1	1620437	1					
Fixing with M3 Device connector, angled, rotatable, with contact carrier, without contacts, for male contacts	1620443	1	1620447	1	1620449	1	1620451	1	1620453	1					
Fixing with M3	1620444	1	1620448	1	1620450	1	1620452	1	1620454	1					
Accessories															
Crimp contacts	Order separately, see page 140 onwards														
Color rings, 50 pcs. in set (to be ordered separately)	See page 180														
Protective caps (to be ordered separately)	See page 181														

**Device connectors,
central fastening thread,
front and rear mounting**

- Compatible with mating connectors with SPEEDCON or M17 standard knurled nuts
- Snapping in the contact carriers from the device side
- Individual marking of connectors with color rings



3+PE, 5+PE, 6+PE-pos.



7+PE, 5+3+PE-pos.

Ordering data					
Order No.	Pcs./Pkt.	Order No.	Pcs./Pkt.	Order No.	Pcs./Pkt.
3+PE-pos.		5+PE-pos.		6+PE-pos.	

Ordering data					
Order No.	Pcs./Pkt.	Order No.	Pcs./Pkt.	Order No.	Pcs./Pkt.
7+PE-pos.		5+3+PE-pos.			

Description

Device connector, front mounting, M18 x 0.75 fastening thread, with contact carrier, without contacts, for female contacts

1613546	1	1613550	1	1613572	1
1613544	1	1613548	1	1613553	1

1613592	1	1613614	1		
1613590	1	1613595	1		

Device connector, front mounting, M18 x 0.75 fastening thread, with contact carrier, without contacts, for male contacts

Device connector, rear mounting, M20 x 1.5 fastening thread, with contact carrier, without contacts, for female contacts

1613547	1	1613551	1	1613587	1
1613545	1	1613549	1	1613568	1

1613593	1	1613629	1		
1613591	1	1613610	1		

Device connector, rear mounting, M20 x 1.5 fastening thread, with contact carrier, without contacts, for male contacts

Accessories			
Type	Order No.	Pcs./Pkt.	

Description

Locking nut, for mounting bore holes and polarization

M18 x 0.75
M20 x 1.5

ST-E2015151	1613831	10	
RC-13041	1600417	10	

Accessories			
Type	Order No.	Pcs./Pkt.	

ST-E2015151	1613831	10	
RC-13041	1600417	10	

Crimp contacts
Color rings, 50 pcs. in set (to be ordered separately)
Protective caps (to be ordered separately)
Unlocking tool for contact carriers

Order separately, see page 140 onwards
See page 180
See page 181
See page 179

Order separately, see page 140 onwards
See page 180
See page 181
See page 179

Circular connectors

M17 power connectors

Crimp contacts, turned

Depending on the number of positions, assemble the M17 power connectors with \varnothing 2 mm, \varnothing 1 mm or \varnothing 0.6 mm contacts (see table below).

Note: Depending on the litz wire used, the connection cross sections (crimp ranges) may deviate from the listed values. For safety reasons, only use female contacts in the live part of the plug.



Crimp contacts, female



Crimp contacts, male

		Ordering data			Ordering data		
Description	Connection cross section [mm ²]	Type	Order No.	Pcs./Pkt.	Type	Order No.	Pcs./Pkt.
Contact, female, \varnothing 2.0 mm	0.25 ... 1.0	ST-20KS010	1607657	50			
	1.0 ... 2.5	ST-20KS020	1607658	50			
Contact, \varnothing 1.0 mm, for signal	0.06 ... 0.25	ST-10KS010	1618239	100			
	0.34 ... 0.50	ST-10KS020	1618251	100			
	0.25 ... 1.0	ST-10KS035	1618464	100			
Contact, female, \varnothing 0.6 mm	0.06 ... 0.25	ST-06KS010	1607580	100			
	0.14 ... 0.34	ST-06KS020	1607581	100			
	0.34 ... 0.50	ST-06KS030	1607582	100			
Contact, male, \varnothing 2.0 mm	0.25 ... 1.0				ST-20KP010	1607655	50
	1.0 ... 2.5				ST-20KP020	1607656	50
Contact, \varnothing 1.0 mm, for signal	0.06 ... 0.25				ST-10KP010	1618255	100
	0.34 ... 0.50				ST-10KP020	1618256	100
	0.25 ... 1.0				ST-10KP035	1618458	100
Contact, male, \varnothing 0.6 mm	0.06 ... 0.25				ST-06KP010	1607577	100
	0.14 ... 0.34				ST-06KP020	1607578	100
	0.34 ... 0.50				ST-06KP030	1607579	100
		Accessories			Accessories		
Crimping tools		Order separately, see page 177			Order separately, see page 177		

Contact diameter

Number of positions	Number of contacts	Contact \varnothing [mm]
4(3+PE)	4	2
6(5+PE)	6	1
7(6+PE)	7	1
8(7+PE)	8	1
9(5+3+PE)	5+3+PE	0.6+1+1
17	17	0.6

Mechanical and electrical data

Mechanical data

Housing material:	Die-cast zinc (GD-Zn)
Housing surface:	Nickel-plated / thick layer passivated (can be coated)
Insulating body:	Polyamide (PA 66)
Contact material:	Copper zinc alloy (CuZn)
Contact surface:	Nickel-plated (Ni) with gold coating (Au)
Connection technology:	Crimp connection
Sealing and O-ring:	Fluororubber (FPM)
Ambient temperature:	-40°C ... 125°C
Cable entry:	External cable diameter 5.5 to 17 mm
Type of locking:	M23 ONECLICK fast locking system, cable connector M23 x 1 coarse-pitch thread as an option
Mechanical insertion cycles:	Standard: 100
Protection class:	IP66/IP68

Electrical data

Number of positions	6 (5+PE)		8 (4+3+PE)			
	5 + PE	4	+	3	+	PE
Contacts	5 + PE	4	+	3	+	PE
Contact Ø [mm]	2	1		2		2
Litz wire cross sections						
Short version, cable Ø max. 14 mm [mm ²]	0.25 ... 2.5	0.06 ... 1.0		0.25 ... 2.5		0.25 ... 2.5
Long version, cable Ø max. 18 mm [mm ²]	0.25 ... 4.0	0.06 ... 1.0		0.25 ... 4.0		0.25 ... 4.0
Device connectors [mm ²]	0.25 ... 4.0	0.06 ... 1.0		0.25 ... 4.0		0.25 ... 4.0
Nominal current per contact at 25°C ¹⁾ [A]	30	9		30		-
Specifications in accordance with DIN EN 61984:2009						
Rated voltage [V AC/DC]	630 ²⁾	250		630 ²⁾		-
Test/surge voltage [kV AC]	6	4		6		-
Overvoltage category	III			III		
Pollution degree ³⁾	3			3		
Installation altitude [m]	Up to 2000			Up to 2000		
Cable clamping area ⁴⁾ Max. Ø [mm]	17			17		

¹⁾ Determine the effective current carrying capacity depending on the application, if necessary, using a derating curve.

²⁾ 400 V when assembled with punched-rolled C-HC contacts

³⁾ The values specified assume that the connector pair is correctly locked and is only disconnected for testing and maintenance purposes. If the connector is unlocked and exposed to ambient conditions, and if there is a danger of pollution, seal the connector using a protective cap ≥ IP54.

⁴⁾ The cable clamping areas specified on the following pages may vary depending on the cable material and structure. Selection and testing is the responsibility of the user.

Contact chamber numbering (view of plug-in side)				
Number of positions	Male		Female	
<p>6-pos. (5 + PE) Crimp</p>		<p>* with grounding spring, pos. 3 leading</p>		<p>* with grounding spring, pos. 3</p>
<p>8-pos. (4 + 3 + PE) Crimp</p>		<p>* with grounding spring, pos. 2</p>		<p>* with grounding spring, pos. 2 leading</p>

Circular connectors

M23 PRO series power connectors

Selection guide

M23 PRO series power connectors
up to 30 A / 630 V, crimping range
up to 4 mm²

- Cable connectors
- Device connectors (device flanges)

The connectors are delivered
pre-assembled. The connectors can
be furnished with the corresponding
crimp contacts.

Every housing type can be assembled
with male or female contacts. The product
chart provides an overview of the available
components.

Connector type

Cable connectors, short design

M23 ONECLICK fast locking system,
see page 146.

M23 x 1 standard locking,
see page 146.



Shielded

ONECLICK Technology TM

Designed by PHOENIX CONTACT

Cable connectors, long design

M23 ONECLICK fast locking system,
see page 146.

M23 x 1 standard locking,
see page 146.



Shielded

ONECLICK Technology TM

Designed by PHOENIX CONTACT

Device connectors

Angled, rotatable,
flange dimensions: 26 mm x 26 mm,
see page 147.



Angled, rotatable,
flange dimensions: 28 mm x 28 mm,
see page 147.



Shielded

Crimp contacts

Tools/accessories

Female contact
Male contact

Female contact
Male contact

Female contact
Male contact

All housings can be fitted with male or female crimp contacts

Female contacts

Turned, see page 148.



Crimping pliers with digital display for turned crimp contacts, see page 177.



Male contacts

Turned, see page 148.



Note:
For safety reasons, only use female contacts in the live part of the connector.

Circular connectors

M23 PRO series power connectors

Cable connectors, short and long design, ONECLICK fast locking system

- Cross-manufacturer connection compatibility
- All housings can be fitted with male or female contacts

Notes:
Touch protection only on the female side



Cable connector, female assembly



Cable connector, male assembly

Description	Cable clamping area
Cable connector, short , with contact carrier, without contacts, crimp connection	
Universal gasket	5.5 mm ... 15 mm
	5.5 mm ... 8 mm
	7.5 mm ... 12 mm
	9.5 mm ... 14.5 mm
Cable connector, long , with contact carrier, without contacts, crimp connection	
Universal gasket	7.5 mm ... 17 mm
	5.5 mm ... 8 mm
	7.5 mm ... 12 mm
	9.5 mm ... 14.5 mm
	14 mm ... 17 mm

Ordering data			
Order No.	Pcs./Pkt.	Order No.	Pcs./Pkt.
5+PE-pos.		4+3+PE-pos.	

1628815	1	1628811	1
1628818	1	1628813	1
1628817	1	1628814	1
1628816	1	1628812	1
1628796	1	1628791	1
1628800	1	1628795	1
1628799	1	1628794	1
1628798	1	1628793	1
1628797	1	1628792	1

Ordering data			
Order No.	Pcs./Pkt.	Order No.	Pcs./Pkt.
5+PE-pos.		4+3+PE-pos.	

1628871	1	1628867	1
1628874	1	1628869	1
1628873	1	1628870	1
1628872	1	1628868	1
1628852	1	1628847	1
1628856	1	1628850	1
1628855	1	1628851	1
1628854	1	1628849	1
1628853	1	1628848	1

Crimp contacts

Accessories
Order separately, see page 148 onwards

Accessories
Order separately, see page 148 onwards

Cable connectors, short and long design, M23 standard locking

- Cross-manufacturer connection compatibility
- All housings can be fitted with male or female contacts

Notes:
Touch protection only on the female side



Cable connector, female assembly



Cable connector, male assembly

Description	Cable clamping area
Cable connector, short , with contact carrier, without contacts, crimp connection	
Universal gasket	5.5 mm ... 15 mm
	5.5 mm ... 8 mm
	7.5 mm ... 12 mm
	9.5 mm ... 14.5 mm
Cable connector, long , with contact carrier, without contacts, crimp connection	
Universal gasket	7.5 mm ... 17 mm
	5.5 mm ... 8 mm
	7.5 mm ... 12 mm
	9.5 mm ... 14.5 mm
	14 mm ... 17 mm

Ordering data			
Order No.	Pcs./Pkt.	Order No.	Pcs./Pkt.
5+PE-pos.		4+3+PE-pos.	

1628823	1	1628819	1
1628826	1	1628822	1
1628825	1	1628821	1
1628824	1	1628820	1
1628806	1	1628801	1
1628810	1	1628805	1
1628809	1	1628804	1
1628808	1	1628803	1
1628807	1	1628802	1

Ordering data			
Order No.	Pcs./Pkt.	Order No.	Pcs./Pkt.
5+PE-pos.		4+3+PE-pos.	

1628879	1	1628875	1
1628882	1	1628878	1
1628881	1	1628877	1
1628880	1	1628876	1
1628862	1	1628857	1
1628866	1	1628861	1
1628865	1	1628860	1
1628864	1	1628859	1
1628863	1	1628858	1

Crimp contacts

Accessories
Order separately, see page 148 onwards

Accessories
Order separately, see page 148 onwards

Device connectors, angled, rotatable

- Cross-manufacturer connection compatibility
- All housings can be fitted with male or female contacts

Notes:
Touch protection only on the female side

new



Device connector, female assembly

new



Device connector, male assembly

Ordering data			
Order No.	Pcs./Pkt.	Order No.	Pcs./Pkt.

Ordering data			
Order No.	Pcs./Pkt.	Order No.	Pcs./Pkt.

Description	Cable clamping area

Device connector, angled, rotatable, with contact carrier, without contacts

Flange dimensions: 26 mm x 26 mm

Device connector, angled, rotatable, with contact carrier, without contacts

Flange dimensions: 28 mm x 28 mm

1628491	1	1628490	1
1628489	1	1628488	1

1628487	1	1628486	1
1628485	1	1628484	1

Accessories
Order separately, see page 148 onwards

Accessories
Order separately, see page 148 onwards

Crimp contacts

Circular connectors

M23 PRO series power connectors

Crimp contacts, turned

Assemble the 5+PE-pos. M23 power connectors with 5 x Ø 2 mm contacts. The 4+3+PE-pos. M23 power connectors are assembled with 4 x Ø 1 mm and 4 x Ø 2 mm contacts.



Crimp contacts, female



Crimp contacts, male

		Ordering data			Ordering data		
Description	Connection cross section [mm ²]	Type	Order No.	Pcs./Pkt.	Type	Order No.	Pcs./Pkt.
Contact Ø 1.0 mm	0.06 ... 0.25	ST-10KS010	1618239	100	ST-10KP010	1618255	100
	0.34 ... 0.50	ST-10KS020	1618251	100	ST-10KP020	1618256	100
	0.25 ... 1.0	ST-10KS035	1618464	100	ST-10KP035	1618458	100
Contact Ø 2.0 mm	0.25 ... 1.0	SF-20KS021	1621576	50	SF-20KP011	1050147	50
	1.0 ... 2.5	SF-20KS022	1621577	50	SF-20KP012	1050205	50
	2.5 ... 4.0	SF-20KS023	1621578	50	SF-20KP013	1050210	50
		Accessories			Accessories		
Crimping tools		Order separately, see page 177 onwards			Order separately, see page 177 onwards		

Mechanical and electrical data

Mechanical data

Housing material:	Copper zinc alloy (CuZn), die-cast zinc (GD-Zn)
Housing surface:	Nickel-plated / thick layer passivated (can be coated)
Insulating body:	Polyamide (PA 66)
Contact material:	Copper zinc alloy (CuZn)
Contact surface:	Nickel-plated (Ni) with gold coating (Au)
Connection technology:	Crimp connection
Sealing and O-ring:	Fluororubber (FPM)
Ambient temperature:	-40°C ... 125°C
Cable entry:	Cable and coupler connectors for an outer cable diameter of 7.5 to 18 mm, shielded
Type of locking:	M23 SPEEDCON screw locking, cable connector M23 x 1 coarse-pitch thread as an option
Mechanical insertion cycles:	Standard: 100
Protection class:	IP67 when locked

Electrical data

Number of positions	6 (5+PE)		8 (4+3+PE)				
	Contacts	5 + PE	4	+	3	+	PE
Contact Ø [mm]		2	1		2		2
Litz wire cross sections							
Short version, cable Ø max. 14 mm [mm ²]		0.25 ... 2.5	0.06 ... 1.0		0.25 ... 2.5		0.25 ... 2.5
Long version, cable Ø max. 18 mm [mm ²]		0.25 ... 4.0	0.06 ... 1.0		0.25 ... 4.0		0.25 ... 4.0
Device connectors [mm ²]		0.25 ... 4.0	0.06 ... 1.0		0.25 ... 4.0		0.25 ... 4.0
Nominal current per contact at 25°C ¹⁾ [A]		30	9		30		-
Specifications in accordance with DIN EN 61984:2009							
Rated voltage [V AC/DC]		630 ²⁾	250		630 ²⁾		-
Test/surge voltage [kV AC]		6	4		6		-
Overvoltage category		III			III		
Pollution degree ³⁾		3			3		
Installation altitude [m]		Up to 3000			Up to 3000		
Cable clamping area ⁴⁾ Max. Ø [mm]		18			18		

¹⁾ Determine the effective current carrying capacity depending on the application, if necessary, using a derating curve.

²⁾ 400 V when assembled with punched-rolled C-HC contacts

³⁾ The values specified assume that the connector pair is correctly locked and is only disconnected for testing and maintenance purposes. If the connector is unlocked and exposed to ambient conditions, and if there is a danger of pollution, seal the connector using a protective cap ≥ IP54.

⁴⁾ The cable clamping areas specified on the following pages may vary depending on the cable material and structure. Selection and testing is the responsibility of the user.

Contact chamber numbering (view of plug-in side)				
Number of positions	Male		Female	
<p>6-pos. (5 + PE) Crimp</p>		<p>* with grounding spring, pos. 3 leading</p>		<p>* with grounding spring, pos. 3</p>
<p>8-pos. (4 + 3 + PE) Crimp</p>		<p>* with grounding spring, pos. 2</p>		<p>* with grounding spring, pos. 2 leading</p>

Circular connectors

M23 power connectors

Selection guide

M23 power connectors up to 30 A/630 V, crimp ranges up to 4 mm²

- Cable connectors
- Coupler connectors
- Device connectors (device flanges)
- Feed-throughs/panel feed-throughs

The connectors are pre-assembled on delivery. The connectors can be furnished with the corresponding crimp contacts.

The product chart provides an overview of the available components.

Connector type

Cable connectors

Short, SPEEDCON fast locking system, see page 154.

M23 x 1 standard interlocking, see page 154.



Long, SPEEDCON fast locking system, see page 154.

M23 x 1 standard interlocking, see page 154.



Shielded

Device connectors with knurled nut

Straight, see page 157.



Angled, see page 157.



Coupler connectors

Short, see page 155.



Long, see page 155.

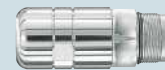

Shielded

With mounting flange
Short, see page 158.



With mounting flange
Long, see page 158.



Device connectors

Straight, see page 156.



Angled, rotatable, flange dimensions: 26 mm x 26 mm, see page 156.



Angled, rotatable, flange dimensions: 28 mm x 28 mm see page 156.



Shielded

Panel feed-throughs

External female – internal male, see page 159.



Panel feed-throughs are supplied fully wired.

Crimp contacts

Tools/accessories

Female contacts

Female contacts

Turned, see page 160.



Crimping pliers with digital display for turned crimp contacts, see page 177.



Male contacts

Male contacts

Turned, see page 160.



Accessories

Color rings for individually marking the connectors, see page 180.



Male contacts

Note:

For safety reasons, only use female contacts in the live part of the connector.

Circular connectors

M23 power connectors

Cable connectors, long and short design

- SPEEDCON fast locking system or M23 standard interlocking
- Standard knurled nut compatible with mating connectors with SPEEDCON and M23 standard external thread
- Individual marking of connectors with color rings



Cable connector, SPEEDCON



Cable connector, M23 standard interlocking

Description	Cable clamping area	Ordering data				Ordering data			
		Order No.	Pcs./Pkt.	Order No.	Pcs./Pkt.	Order No.	Pcs./Pkt.	Order No.	Pcs./Pkt.
		5+PE-pos.		4+3+PE-pos.		5+PE-pos.		4+3+PE-pos.	
Cable connector, short, with contact carrier, without contacts, for cable Ø 7.5 mm to 14 mm, connection cross section up to 2.5 mm²									
Universal gasket	7.5 mm ... 14 mm	1618197	1	1618207	1	1605532	1	1605602	1
	7.5 mm ... 9 mm	1618194	1	1618204	1	1605524	1	1605595	1
	9 mm ... 11 mm	1618195	1	1618205	1	1605526	1	1605596	1
	11 mm ... 14 mm	1618196	1	1618206	1	1605529	1	1605597	1
Cable connector, long, with contact carrier, without contacts, for cable Ø 7.5 mm to 18 mm, connection cross section up to 4 mm²									
Universal gasket	7.5 mm ... 18 mm	1618202	1	1618212	1	1605549	1	1605617	1
	7.5 mm ... 9 mm	1618201	1	1618211	1	1605548	1	1605614	1
	9 mm ... 12 mm	1618200	1	1618210	1	1605546	1	1605610	1
	12 mm ... 15 mm	1618199	1	1618209	1	1605545	1	1605607	1
	15 mm ... 18 mm	1618198	1	1618208	1	1605543	1	1605605	1
Accessories									
Crimp contacts		For female contacts, see page 160				For female contacts, see page 160			
Color rings, 50 pcs. in set (to be ordered separately)		See page 180				See page 180			
Protective caps (to be ordered separately)		See page 181				See page 181			

Coupler connectors, long and short design

- Compatible with mating connectors with SPEEDCON and M23 standard knurled nut
- Individual marking of connectors with color rings



Coupler connector, short



Coupler connector, long

		Ordering data				Ordering data			
Description	Cable clamping area	Order No.	Pcs./Pkt.	Order No.	Pcs./Pkt.	Order No.	Pcs./Pkt.	Order No.	Pcs./Pkt.
		Coupler connector, short, with contact carrier, without contacts, for cable Ø 7.5 mm to 14 mm, connection cross section up to 2.5 mm²		5+PE-pos.		4+3+PE-pos.		5+PE-pos.	
Universal gasket	7.5 mm ... 14 mm	1605499	1	1605575	1				
	7.5 mm ... 9 mm	1605494	1	1605568	1				
	9 mm ... 11 mm	1605496	1	1605570	1				
	11 mm ... 14 mm	1605498	1	1605571	1				
Coupler connector, long, with contact carrier, without contacts, for cable Ø 7.5 mm to 18 mm, connection cross section up to 4 mm²									
Universal gasket	7.5 mm ... 18 mm					1605510	1	1605583	1
	7.5 mm ... 9 mm					1605509	1	1605582	1
	9 mm ... 12 mm					1605508	1	1605581	1
	12 mm ... 15 mm					1605507	1	1605580	1
	15 mm ... 18 mm					1605505	1	1605578	1
		Accessories				Accessories			
Crimp contacts		For male contacts, see page 160				For male contacts, see page 160			
Color rings, 50 pcs. in set (to be ordered separately)		See page 180				See page 180			
Protective caps (to be ordered separately)		See page 181				See page 181			

Circular connectors

M23 power connectors

Device connectors, straight and angled, rotatable

- Compatible with mating connectors with SPEEDCON and M23 standard knurled nut



Device connector, straight



Device connector, angled rotatable

Description	Ordering data				Ordering data			
	Order No.	Pcs./Pkt.	Order No.	Pcs./Pkt.	Order No.	Pcs./Pkt.	Order No.	Pcs./Pkt.
Device connector , with contact carrier without contacts	5+PE-pos.		4+3+PE-pos.		5+PE-pos.		4+3+PE-pos.	
Flange dimensions: 26 mm x 26 mm	1605520	1	1605589	1	1620657	1	1620660	1
Device connector , with reinforced contact carrier (black) for angled mating connectors, without contacts								
Flange dimensions: 26 mm x 26 mm	1620619	1	1620620	1				
Device connector with contact carrier without contacts								
Flange dimensions: 28 mm x 28 mm					1620661	1	1620662	1
Accessories				Accessories				
Crimp contacts	For male contacts, see page 160				For male contacts, see page 160			
Color rings, 50 pcs. in set (to be ordered separately)	See page 180				See page 180			
Protective caps (to be ordered separately)	See page 181				See page 181			

Device connectors, with knurled nut

Only assemble device connectors with knurled nut with female contacts.
 – Standard knurled nut compatible with mating connectors with SPEEDCON and M23 standard external thread



Device connector with knurled nut, straight



Device connector with knurled nut, angled fixed

Description	Ordering data				Ordering data				
	Order No.	Pcs./Pkt.	Order No.	Pcs./Pkt.	Order No.	Pcs./Pkt.	Order No.	Pcs./Pkt.	
Device connector, with knurled nut, straight , with contact carrier, without contacts									
	5+PE-pos.		4+3+PE-pos.		5+PE-pos.		4+3+PE-pos.		
	1607082	1	1605622	1					
Device connector, with knurled nut, angled, fixed , with contact carrier, without contacts									
					1607405		1607429		
					1		1		
		Accessories				Accessories			
Crimp contacts	For female contacts, see page 160				For female contacts, see page 160				
Protective caps (to be ordered separately)	See page 181				See page 181				

Circular connectors

M23 power connectors

Panel feed-throughs, long and short design

- Rear mounting
- Compatible with mating connectors with M23 standard knurled nuts



Panel feed-through, short



Panel feed-through, long

		Ordering data				Ordering data			
Description	Cable clamping area	Order No.	Pcs./Pkt.	Order No.	Pcs./Pkt.	Order No.	Pcs./Pkt.	Order No.	Pcs./Pkt.
		5+PE-pos.		4+3+PE-pos.		5+PE-pos.		4+3+PE-pos.	
Panel feed-through, short , with contact carrier, without contacts, for cable Ø 7.5 to 14 mm, connection cross section up to 2.5 mm ²									
Universal gasket	7.5 mm ... 14 mm	1605517	1	1607051	1				
	7.5 mm ... 9 mm	1605516	1	1607048	1				
	9 mm ... 11 mm	1607037	1	1607049	1				
	11 mm ... 14 mm	1607038	1	1607050	1				
Panel feed-through, long , with contact carrier, without contacts, for cable Ø 7.5 to 18 mm, connection cross section up to 4 mm ²									
Universal gasket	7.5 mm ... 18 mm					1605518	1	1607056	1
	7.5 mm ... 9 mm					1607042	1	1607055	1
	9 mm ... 12 mm					1607041	1	1607054	1
	12 mm ... 15 mm					1607040	1	1607053	1
	15 mm ... 18 mm					1607039	1	1607052	1
		Accessories				Accessories			
Crimp contacts		For male contacts, see page 160				For male contacts, see page 160			
Color rings, 50 pcs. in set (to be ordered separately)		See page 180				See page 180			
Protective caps (to be ordered separately)		See page 181				See page 181			

**Panel feed-throughs,
fully wired**

- Front mounting
- Internally fully wired and fitted with contacts
- Compatible with mating connectors with M23 standard knurled nuts



Panel feed-through, male/female

Description	Ordering data			
	Order No.	Pcs./Pkt.	Order No.	Pcs./Pkt.
Panel feed-through, male inside - female outside, fully wired, with contacts	5+PE-pos.		4+3+PE-pos.	
	1605492	1	1605567	1
Accessories				
Protective caps (to be ordered separately)	See page 181			

Circular connectors

M23 power connectors

Crimp contacts, turned

Assemble the 6-pos. (5+PE) versions with two Ø 2 mm contacts. Assemble the 8-pos. (4+3+PE) versions with four Ø 1 mm signal contacts and four Ø 2 mm contacts.

Note: observe the crimp ranges for cable and coupler connectors.

- Short version: connection cross sections up to 2.5 mm², max. cable Ø of 14 mm
- Long version: connection cross sections up to 4 mm², max. cable Ø of 18 mm



Crimp contacts, female



Crimp contacts, male

ERC

Description	Connection cross section [mm ²]	Ordering data			Ordering data		
		Type	Order No.	Pcs./Pkt.	Type	Order No.	Pcs./Pkt.
Contact, female Ø 2.0 mm for cable and device connectors with knurled nuts, power and PE contacts	0.25 ... 1.0	SF-7PS2000	1605636	50			
	0.75 ... 1.5	SF-7NS2000	1605631	50			
	1.0 ... 2.5	SF-7QS2000	1605643	50			
	4.0	SF-7MS2000	1605628	50			
Contact, female Ø 1.0 mm for cable and device connectors with knurled nuts, signal contacts	0.06 ... 0.2	SF-6CS2000	1605562	100			
	0.14 ... 0.5	SF-10KS004	1607356	100			
	0.5 ... 1.0	SF-6AS2000	1605557	100			
Contact, male Ø 2.0 mm for coupler connectors, power and PE contacts	0.14 ... 0.25				SF-7RP2000	1605646	50
	0.25 ... 1.0				SF-7PP2000	1605634	50
	0.75 ... 1.5				SF-20KP004	1607376	50
	1.0 ... 2.5				SF-7QP2000	1605639	50
	4.0				SF-7MP2000	1605626	50
Contact, male Ø 1.0 mm for coupler connectors, signal contacts	0.06 ... 0.2				SF-6CP2000	1605559	100
	0.14 ... 0.5				SF-10KP004	1607355	100
	0.5 ... 1.0				SF-6AP2000	1605554	100
Contact, male Ø 2.0 mm for device connectors, power and PE contacts	0.14 ... 0.25				SF-7RP2000	1605646	50
	0.25 ... 1.0				SF-7PP2000	1605634	50
	0.75 ... 1.5				SF-20KP004	1607376	50
	1.0 ... 2.5				SF-7QP2000	1605639	50
	4.0				SF-7MP2000	1605626	50
Contact, male Ø 1.0 mm for device connectors, signal contacts	0.06 ... 0.2				SF-6CP2000	1605559	100
	0.14 ... 0.5				SF-10KP004	1607355	100
	0.5 ... 1.0				SF-6AP2000	1605554	100
Crimping tools		Accessories			Accessories		
		Order separately, see page 177 onwards			Order separately, see page 177 onwards		

Contact diameter

Number of positions	Number of contacts	Contact Ø [mm]
6(5+PE)	5+PE	2+2
8(4+3+PE)	4+3+PE	1+2+2

Mechanical and electrical data

Mechanical data	
Housing material:	Copper zinc alloy (CuZn), die-cast zinc (GD-Zn)
Housing surface:	Nickel-plated/thick layer passivated (can be coated)
Insulating body:	Polyamide (PA 66)
Contact material:	Copper zinc alloy (CuZn)
Contact surface:	Nickel-plated (Ni) with gold coating (Au)
Connection technology:	Crimp connection
Sealing and O-ring:	Fluororubber (FKM)
Ambient temperature:	-40°C ... 125°C
Cable entry:	Outer cable diameter 9.0 to 26.5 mm, shielded
Type of locking:	M40 SPEEDCON fast locking system, cable connector with M40 x 1.5 coarse-pitch thread as an option
Mechanical insertion/withdrawal cycles:	Standard: 50
Protection class	IP67 when locked

Electrical data											
Number of positions		6 (2 + 3 + PE)				8 (4 + 3 + PE)					
Contacts		2	+	3	+	PE	4	+	3	+	PE
Contact Ø	[mm]	2.0		3.6		3.6	2.0		3.6		3.6
Litz wire cross sections											
Cable and coupler connectors	[mm²]	0.14 ... 4.0		0.75 ... 10		0.75 ... 10	0.14 ... 4.0		0.75 ... 10		0.75 ... 10
Device connectors	[mm²]	0.14 ... 4.0		0.75 ... 10		0.75 ... 10	0.14 ... 4.0		0.75 ... 10		0.75 ... 10
Nominal current per contact at 25°C ¹⁾	[A]	30		70		–	30		70		–
Specifications in accordance with DIN EN 1984:2009											
Rated voltage	[V AC/DC]	250		630		–	250		630		–
Test/surge voltage	[kV]	4		6		–	4		6		–
Overvoltage category		III				III					
Pollution degree		3				3					
Installation height	[m]	Up to 3000				Up to 3000					
Cable clamping area ²⁾	Max. Ø [mm]	26.5				26.5					

¹⁾ Determine the effective current carrying capacity in accordance with the application, if necessary, using a derating curve.

²⁾ The cable clamping areas specified on the following pages may vary depending on the cable material and structure. Selection and testing is the responsibility of the user.

Contact chamber numbering
(view of plug-in side)

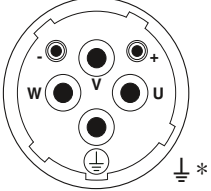
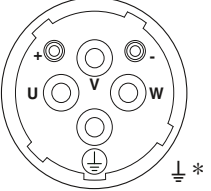
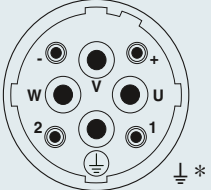
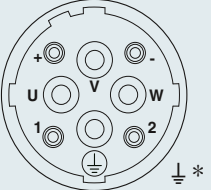
Number of positions	Male	Female
<p>6-pos. (2 + 3 + PE) Crimp</p>		
<p>8-pos. (4 + 3 + PE) Crimp</p>		

* with grounding spring

Circular connectors

M40 power connectors

Selection guide

M40 power connectors up to 70 A/630 V, crimp ranges up to 16 mm²

- Cable connectors
- Coupler connectors
- Device connectors (device flanges)
- Feed-throughs/panel feed-throughs

The connectors are pre-assembled on delivery. The connectors can be furnished with the corresponding crimp contacts.

M40 connectors with knurled nuts can be supplied with SPEEDCON fast locking system or with M40 x 1.5 coarse-pitch thread as an option.

The product chart provides an overview of the available components.

Connector type

Cable connectors

SPEEDCON fast locking system, see page 166.

Shielded



Mounting flange for wall mounting, see page 179.



M40 x 1.5 standard interlocking, see page 166.



Device connectors with knurled nut

Straight, see page 167.

Shielded



Angled, see page 167.



Coupler connectors

See page 166.

Shielded



Device connectors

Angled, rotatable, see page 168.

Straight, see page 166.



Crimp contacts

Tools/accessories

Female contacts

Female contacts

Turned, see page 169.



Crimping tools

Crimping pliers, see page 177.



Crimping pliers with digital display for turned crimp contacts, see page 177.



Male contacts

Male contacts

Turned, see page 169.



Accessories

Color rings for individually marking the connectors, see page 180.

**Note:**

For safety reasons, only use female contacts in the live part of the connector.

Circular connectors

M40 power connectors

Cable connectors

- SPEEDCON fast locking system or M40 standard interlocking
- Standard knurled nut compatible with mating connectors with SPEEDCON or M40 standard external thread
- Individual marking of connectors with color rings



Cable connector, SPEEDCON



Cable connector

Description	Cable clamping area	Ordering data				Ordering data			
		Order No.	Pcs./Pkt.	Order No.	Pcs./Pkt.	Order No.	Pcs./Pkt.	Order No.	Pcs./Pkt.
Cable connector housing , with contact carrier, without contacts, connection cross section up to 16 mm ²		2+3+PE-pos.		4+3+PE-pos.		2+3+PE-pos.		4+3+PE-pos.	
	9 mm ... 14 mm	1613428	1	1613434	1	1613518	1	1613528	1
	14 mm ... 20.5 mm	1613429	1	1613435	1	1613519	1	1613529	1
	20.5 mm ... 26.5 mm	1613430	1	1613436	1	1613520	1	1613530	1
		Accessories				Accessories			
Crimp contacts		For female contacts, see page 169				For female contacts, see page 169			
Color rings, 50 pcs. in set (to be ordered separately)		See page 180				See page 180			
Protective caps (to be ordered separately)		See page 181				See page 181			

Coupler and device connectors

- Compatible with mating connectors with SPEEDCON and M40 standard knurled nut
- Individual marking of connectors with color rings



Coupling connector



Device connector, straight

Description	Cable clamping area	Ordering data				Ordering data			
		Order No.	Pcs./Pkt.	Order No.	Pcs./Pkt.	Order No.	Pcs./Pkt.	Order No.	Pcs./Pkt.
Coupler connector , with contact carrier, without contacts, connection cross section up to 16 mm ²		2+3+PE-pos.		4+3+PE-pos.		2+3+PE-pos.		4+3+PE-pos.	
	9 mm ... 14 mm	1613425	1	1613431	1				
	14 mm ... 20.5 mm	1613426	1	1613432	1				
	20.5 mm ... 26.5 mm	1613427	1	1613433	1				
Device connector, straight , with contact carrier, without contacts									
Connection cross section up to 10 mm ²						1613517	1	1613527	1
		Accessories				Accessories			
Crimp contacts		For male contacts, see page 169				For male contacts, see page 169			
Color rings, 50 pcs. in set (to be ordered separately)		See page 180				See page 180			
Protective caps (to be ordered separately)		See page 181				See page 181			

Device connectors, with knurled nut

- SPEEDCON fast locking system or M40 standard interlocking
- Standard knurled nut compatible with mating connectors with SPEEDCON or M40 standard external thread
- Only assemble device connectors with knurled nut with female contacts



Device connector with knurled nut, straight, SPEEDCON



Device connector with knurled nut, straight

Ordering data			
Order No.	Pcs./Pkt.	Order No.	Pcs./Pkt.
	2+3+PE-pos.		4+3+PE-pos.

Ordering data			
Order No.	Pcs./Pkt.	Order No.	Pcs./Pkt.
	2+3+PE-pos.		4+3+PE-pos.

Description
Device connector, with SPEEDCON knurled nut, straight, with contact carrier, without contacts
Connection cross section up to 16 mm ²
Device connector, with standard knurled nut, straight, with contact carrier, without contacts
Connection cross section up to 16 mm ²

1613524	1	1613534	1
---------	---	---------	---

1605823	1	1605865	1
---------	---	---------	---

Accessories	
For female contacts, see page 169	See page 180
Color rings, 50 pcs. in set (to be ordered separately)	See page 181
Protective caps (to be ordered separately)	

Accessories	
For female contacts, see page 169	See page 180
Color rings, 50 pcs. in set (to be ordered separately)	See page 181
Protective caps (to be ordered separately)	

Device connectors, with knurled nut

Only assemble device connectors with knurled nut with female contacts.



Device connector with knurled nut, angled, SPEEDCON



Device connector with knurled nut, angled

Ordering data			
Order No.	Pcs./Pkt.	Order No.	Pcs./Pkt.
	2+3+PE-pos.		4+3+PE-pos.

Ordering data			
Order No.	Pcs./Pkt.	Order No.	Pcs./Pkt.
	2+3+PE-pos.		4+3+PE-pos.

Description
Device connector, with SPEEDCON knurled nut, angled, with contact carrier, without contacts
Connection cross section up to 16 mm ²
Device connector, with knurled nut, angled, with contact carrier, without contacts
Connection cross section up to 16 mm ²

1613525	1	1613535	1
---------	---	---------	---

1607532	1	1607543	1
---------	---	---------	---

Accessories	
For female contacts, see page 169	See page 180
Color rings, 50 pcs. in set (to be ordered separately)	See page 181
Protective caps (to be ordered separately)	

Accessories	
For female contacts, see page 169	See page 180
Color rings, 50 pcs. in set (to be ordered separately)	See page 181
Protective caps (to be ordered separately)	

Circular connectors

M40 power connectors

Device connectors, angled, rotatable

- Compatible with mating connectors with SPEEDCON and M40 standard knurled nut
- The rotatable angled housing can be rotated freely through 310°.
- Individual marking of connectors with color rings



**Device connector,
angled rotatable**

Ordering data

Description	Order No.	Pcs./Pkt.	Order No.	Pcs./Pkt.
	Device connector, angled, rotatable, with contact carrier, without contacts	2+3+PE-pos.		4+3+PE-pos.
Connection cross section up to 10 mm ²	1620663	1	1620664	1

Accessories

Crimp contacts	For male contacts, see page 169
Color rings, 50 pcs. in set (to be ordered separately)	See page 180
Protective caps (to be ordered separately)	See page 181

Crimp contacts, turned

Assemble the 6-pos. (2+3+PE) versions with two Ø 2 mm signal contacts and four Ø 3.6 mm contacts (three power contacts and one PE contact).

Assemble the 8-pos. (4+3+PE) versions with four Ø 2 mm signal contacts and four Ø 3.6 mm contacts (three power contacts and one PE contact).

Note: Depending on the litz wire used, the connection cross sections (crimp ranges) can differ from the values listed below.



Crimp contacts, female



Crimp contacts, male

		Ordering data			Ordering data		
Description	Connection cross section [mm ²]	Type	Order No.	Pcs./Pkt.	Type	Order No.	Pcs./Pkt.
Contact, female Ø 3.6 mm, for cable and device connectors with knurled nuts, power and PE contacts							
	1.0 ... 2.5	SM-36KS001	1605756	20			
	2.5 ... 4.0	SM-36KS002	1605758	20			
	4.0 ... 6.0	SM-36KS003	1605760	20			
	6.0 ... 10.0	SM-36KS004	1605762	20			
	16	SM-36KS016	1623972	20			
Contact, female Ø 2.0 mm, for cable and device connectors with knurled nuts, signal contacts							
	0.25 ... 1.0	SF-7PS2000	1605636	50			
	0.75 ... 1.5	SF-7NS2000	1605631	50			
	1.0 ... 2.5	SF-7QS2000	1605643	50			
	4.0	SF-7MS2000	1605628	50			
Contact, male Ø 3.6 mm, for coupler connectors, power and PE contacts							
	1.0 ... 2.5				SM-36KP005	1605749	20
	2.5 ... 4.0				SM-36KP006	1605750	20
	4.0 ... 6.0				SM-36KP008	1605754	20
	6.0 ... 10.0				SM-36KP007	1605752	20
	16				SM-36KP016	1623970	20
Contact, male Ø 2.0 mm, for coupler connectors, signal contacts							
	0.25 ... 1.0				SM-20KP006	1605738	50
	0.75 ... 1.5				SM-20KP005	1605736	50
	1.0 ... 2.5				SM-20KP007	1605739	50
	4.0				SM-20KP008	1605741	50
Contact, male Ø 3.6 mm, for device connectors, power and PE contacts							
	0.75 ... 1.5				SM-36KP001	1605743	20
	1.0 ... 2.5				SM-36KP009	1607057	20
	4.0 ... 6.0				SM-36KP003	1605745	20
	6.0 ... 10.0				SM-36KP004	1605747	20
Contact, male Ø 2.0 mm, for device connectors, signal contacts							
	0.14 ... 0.25				SF-7RP2000	1605646	50
	0.25 ... 1.0				SF-7PP2000	1605634	50
	0.75 ... 1.5				SF-20KP004	1607376	50
	1.0 ... 2.5				SF-7QP2000	1605639	50
	4.0				SF-7MP2000	1605626	50
		Accessories			Accessories		
Crimping tools		Order separately, see page 177			Order separately, see page 177		

Number of positions	Number of contacts	Contact Ø [mm]
6(2+3+PE)	2+3+PE	2+3.6+3.6
8(4+3+PE)	4+3+PE	2+3.6+3.6

Mechanical and electrical data

Mechanical data

Housing material:	Aluminum
Housing surface:	Aluminum, anodized
Insulating body:	Polyamide (PA 66)
Contact surface:	Power and PE contacts: silver-plated (Ag), signal contacts: gold-plated (Au)
Connection technology:	Crimp connection
Sealing and O-ring:	Fluororubber (FPM)
Ambient temperature:	-40°C ... 120°C
Cable entry:	Cable and coupler connectors for an outer cable diameter of 17 to 36 mm, shielded
Type of locking:	M58 x 2 screw locking
Mechanical insertion/withdrawal cycles:	Standard: 100
Protection class:	IP67 when locked

Electrical data

Number of positions	6 (2 + 3 + PE)			8 (4 + 3 + PE)		
	2	3	PE	4	3	PE
Contacts	2	3	PE	4	3	PE
Contact Ø [mm]	1.6	10	10	1.6	10	10
Litz wire cross section						
Crimp contacts, turned [mm ²]	0.75 ... 1.5	10 ... 50	10 ... 50	0.75 ... 1.5	10 ... 50	10 ... 50
Nominal current per contact at 25°C ¹⁾ [A]	12	150	–	12	150	–
Specifications in accordance with DIN EN 61984:2009						
Rated voltage [V AC/DC]	250	630	–	250	630	–
Test/surge voltage [kV AC]	4	6	–	4	6	–
Overvoltage category		III			III	
Pollution degree		3			3	
Installation height [m]		Up to 2000			Up to 2000	
Cable clamping area ²⁾ Max. Ø [mm]		36			36	

¹⁾ Determine the effective current carrying capacity in accordance with the application, if necessary, using a derating curve.

²⁾ The cable clamping areas specified on the following pages may vary depending on the cable material and structure. Selection and testing is the responsibility of the user.

Note:

In contrast to connecting equipment, connectors may only be inserted/withdrawn with the power supply disconnected.

Contact chamber numbering
(view of plug-in side)

Number of positions	Male	Female
<p>6-pos. (2 + 3 + PE) Crimp</p>		
<p>8-pos. (4 + 3 + PE) Crimp</p>		

* with grounding spring,
PE leading

Circular connectors

M58 power connectors

Selection guide

M58 power connectors up to 150 A/630 V, crimp ranges up to 50 mm²

- Cable connectors
- Coupler connectors
- Device connectors, straight

The connectors are pre-assembled on delivery. The connectors can be furnished with the corresponding crimp contacts.

The product chart provides an overview of the available components.

Connector type

Cable connectors

Shielded



See page 174.

Coupler connectors

Shielded



See page 174.

Device connectors

Shielded



See page 174.

Crimp contacts

Female contacts

Turned, see page 175.



Female contacts

Male contacts

Turned, see page 175.



Male contacts

Male contacts

Tools/accessories

Crimping tools

Crimping device for power and PE contacts
Ø 10 mm, see page 178.



Crimping pliers for signal contacts Ø 1.6 mm,
see page 178.

**Note:**

For safety reasons, only use female contacts in the live part of the connector.

Circular connectors

M58 power connectors

Cable and coupler connectors

- High transmission capacities of up to 630 V and 150 A
- Connection cross sections up to 50 mm²
- Cable clamping area from 17 mm to 36 mm



Cable connector



Coupling connector

Description	Cable clamping area	Ordering data				Ordering data			
		Order No.	Pcs./Pkt.	Order No.	Pcs./Pkt.	Order No.	Pcs./Pkt.	Order No.	Pcs./Pkt.
Connector housing , with contact carrier, without contacts, for cable diameter:	17 mm ... 25 mm								
	25 mm ... 36 mm								
		2+3+PE-pos.		4+3+PE-pos.		2+3+PE-pos.		4+3+PE-pos.	
		1607503	1	1607508	1	1607500	1	1607506	1
		1607501	1	1607507	1	1607499	1	1607505	1
		Accessories				Accessories			
Crimp contacts		For female contacts, see page 175				For male contacts, see page 175			
Protective caps (to be ordered separately)		See page 181				See page 181			

Device connectors for front mounting

Assemble the coupler and device connectors with male contacts and the cable connectors with female contacts.



Device connector, straight

Description	Ordering data			
	Order No.	Pcs./Pkt.	Order No.	Pcs./Pkt.
Device connector, straight , with contact carrier, without contacts				
	2+3+PE-pos.		4+3+PE-pos.	
	1615686	1	1615687	1
	Accessories			
Crimp contacts	For male contacts, see page 175			
Protective caps (to be ordered separately)	See page 181			

Crimp contacts, turned

Assemble the 6-pos. (2+3+PE) versions with two Ø 1.6 mm signal contacts and four Ø 10 mm contacts (three power contacts and one PE contact).

Assemble the 8-pos. (4+3+PE) versions with four Ø 1.6 mm signal contacts and four Ø 10 mm contacts (three power contacts and one PE contact).

Note: Depending on the litz wire used, the connection cross sections (crimp ranges) can differ from the values listed below.



Crimp contacts, female



Crimp contacts, male

		Ordering data			Ordering data		
Description	Connection cross section [mm ²]	Type	Order No.	Pcs./Pkt.	Type	Order No.	Pcs./Pkt.
Contact, female Ø 10.0 mm for cable connectors, power and PE contacts	10.0	SL-1CKS010	1607916	4			
	16.0	SL-1CKS020	1607917	4			
	25.0	SL-1CKS030	1607918	4			
	35.0	SL-1CKS040	1607919	4			
	50.0	SL-1CKS050	1607920	4			
Contact, female Ø 1.6 mm for cable connectors, signal contacts	0.75 ... 1.5	SL-16KS010	1607956	4			
Contact, male Ø 10.0 mm for coupler and device connectors, power and PE contacts	10.0				SL-1CKP010	1607911	4
	16.0				SL-1CKP020	1607912	4
	25.0				SL-1CKP030	1607913	4
	35.0				SL-1CKP040	1607914	4
	50.0				SL-1CKP050	1607915	4
Contact, male Ø 1.6 mm for coupler and device connectors, signal contacts	0.75 ... 1.5				SL-16KP010	1607909	4
		Accessories			Accessories		
Crimping tools		Order separately, see page 178 onwards			Order separately, see page 178 onwards		

Number of positions	Number of contacts	Contact Ø [mm]
6(2+3+PE)	2+3+PE	1.6+10+10
8(4+3+PE)	4+3+PE	1.6+10+10

Circular connectors

Tools and accessories

Special wrench

The torque screw driver is specially adapted to the M23 circular connectors and simplifies the process of tightening and loosening the knurled nut safely even in places where space is restricted.

The tool consists of a hook spanner as well as a torque screw driver with a set torque of 2.5 Nm.



Torque screw driver for M23 connectors with knurled nuts



Special screw key for screwing the adapter

Description		Ordering data			Ordering data		
Wrench size [mm]		Type	Order No.	Pcs./Pkt.	Type	Order No.	Pcs./Pkt.
Torque screw driver incl. hook wrench		SF-Z0028	1607456	1			
For M23 connectors with knurled nuts		SF-Z0027	1607455	1			
Replacement hook spanner for torque screw driver							
Special wrench for cable or coupler connectors for screwing the adapter. Connection dimensions for torque spanner: 8.9 mm x 11.9 mm					ST-Z0012	1613667	1
for M17 connectors, WAF 19					RF-Z0007	1614347	1
for M23 connectors, WAF 24					SM-Z0012	1614349	1
for M40 connectors, WAF 41					SL-Z0016	1614348	1
for M58 connectors, WAF 55							

Crimping tools and accessories for M23 signal connectors

The RC-Z2130 and RC-Z2514 crimping pliers are used for rolled or turned RC crimp contacts.

The RC-Z2514 crimping pliers with 4-mandrel crimping are suitable for turned RC contacts. Detailed operating instructions are included in the packaging.



Crimping tools for rolled or turned RC contacts



Insertion and contact removal tool for RC contacts

Description		Ordering data			Ordering data		
		Type	Order No.	Pcs./Pkt.	Type	Order No.	Pcs./Pkt.
Crimping pliers for rolled RC crimp contacts Ø 1 mm		RC-Z2130	1604267	1			
Litz wire cross section 0.08 ... 0.56 mm ²							
Crimping pliers for turned RC crimp contacts Ø 1 mm / Ø 1.5 mm / Ø 2 mm		RC-Z2514	1614590	1			
Litz wire cross section of 0.08 ... 2.5 mm ²							
Insertion and contact removal tool for RC crimp contacts					RC-Z2494	1614123	1
Female / male Ø 1 mm					RC-Z2274	1604409	1
Female / male Ø 1.5 mm					RC-Z2490	1611803	1
Female / male Ø 2 mm							

Crimping tools for turned contacts

The crimping pliers are suitable for turned contacts with \varnothing 0.6 mm, \varnothing 1 mm, \varnothing 2 mm, and \varnothing 3.6 mm (excluding M23 signal connectors). A pneumatic crimping tool is available for large litz wire cross sections.

Notes:

For crimping tools for M23 signal connectors, see page 176



Manual crimping pliers

ERC

Ordering data

Description	Litz wire cross section [mm ²]	Type	Order No.	Pcs./Pkt.
Manual crimping pliers with digital display for turned crimp contacts with \varnothing 1 mm, \varnothing 2 mm, \varnothing 3.6 mm	0.06 ... 6	SF-Z0025	1607452	1
Positioners for crimping the SF-6FS2000 / SF-6DP2000 contacts with a connection cross section of 1.5 mm ²		SF-Z0042	1613666	1
Manual crimping pliers with digital display for turned crimp contacts with \varnothing 0.6 mm, \varnothing 1 mm, \varnothing 2 mm	0.06 ... 2.5	SF-Z0054	1615585	1
Manual crimping pliers with digital display for turned crimp contacts with \varnothing 2 mm, \varnothing 3.6 mm	1.5 ... 10	SF-Z0026	1607454	1
Locator for SF-Z0026 crimping pliers, for crimping turned M40 hybrid contacts, \varnothing 3.6 mm	2.5 ... 6	SB-Z0026	1624618	1
Manual crimping pliers , for turned crimp contacts, \varnothing 3.6 mm	10 ... 16	SB-Z0016	1624515	1

Circular connectors

Tools and accessories

Crimping tools for turned contacts for M58 power connectors

The SF-Z0025 manual crimping pliers are used for turned crimp contacts with Ø 1.6 mm for M58 power connectors. The Ø 10 mm contacts can be crimped conveniently using the SL-Z0007 electric crimping tool.

The crimping stamps for the Ø 10 mm contacts are used in pairs. The stamps are tailored to the connection cross sections and marked.



Electro-hydraulic crimping device



Manual crimping pliers

ERC

		Ordering data			Ordering data		
Description	Connection cross section [mm ²]	Type	Order No.	Pcs./Pkt.	Type	Order No.	Pcs./Pkt.
Electro-hydraulic crimping device incl. charger and rechargeable battery, for Litz wire cross section 10 ... 50 mm² (power and PE contacts Ø 10 mm)		SL-Z0007	1613484	1			
Crimping stamp for crimping device SL-Z0007	10	SL-Z0011	1613488	1			
Crimping stamp for crimping device SL-Z0007	16	SL-Z0012	1613489	1			
Crimping stamp for crimping device SL-Z0007	25	SL-Z0013	1613490	1			
Crimping stamp for crimping device SL-Z0007	35	SL-Z0014	1613491	1			
Crimping stamp for crimping device SL-Z0007	50	SL-Z0015	1613492	1			
Crimping tool with digital display	0.06 ... 6				SF-Z0025	1607452	1
Accessories for electro-hydraulic crimping device SL-Z0007							
	Replacement battery	SL-Z0008	1613485	1			
	Table holder incl. foot actuation switch	SL-Z0010	1613487	1			

Notes:

The SF-Z0025 manual crimping pliers with digital display are also suitable for crimping ST / SF / SM turned crimp contacts.

**Contact removal tools,
square mounting flange**

The removal tool is used for those contact carriers which are snapped into the housing without rear support. They are removed from the plug-in side using the removal tool.

The square mounting flange is used for cable and coupling connectors. In this way, the product range is easily expanded with connectors as panel feed-throughs.



**Contact removal tool
for snap-in contact carriers**



**Square mounting flange
for cable or coupler connectors
for wall mounting**

			Ordering data			Ordering data		
Description	Wall mounting		Type	Order No.	Pcs./Pkt.	Type	Order No.	Pcs./Pkt.
Contact removal tool for contact carriers, device connectors								
		for M17 signal or power connectors	ST-Z0001	1607770	1			
		For M23 feedback connectors	RF-Z0001	1607904	1			
		For M23 signal connectors	CA-Z0001	1620699	1			
Square mounting flange, metal, with O-ring gasket, for M17 (excluding M17 Compact) cable and coupler connectors for wall mounting						ST-Z0002	1607771	1
		4 x Ø 2.7 mm				ST-Z0003	1607772	1
		4 x M3						
Square mounting flange, metal, without O-ring gasket, for M17 (excluding M17 Compact) cable and coupler connectors for wall mounting						ST-Z0004	1607773	1
		4 x Ø 2.7 mm				ST-Z0005	1607775	1
		4 x M3						
Square mounting flange, metal, with O-ring gasket, for M23 feedback cable and coupler connectors for wall mounting						RF-Z0003	1607905	1
		4 x M3						
Square mounting flange, metal, with O-ring gasket, for M40 cable and coupler connectors for wall mounting						SM-Z0003	1607935	1
		4 x Ø 4.3 mm				SM-Z0004	1607937	1
		4 x M3						
Square mounting flange, metal, without O-ring gasket, for M40 cable and coupler connectors for wall mounting								
		4 x Ø 4.3 mm						

Installation dimensions for square mounting flanges

Type	Installation dimensions			Flange dimensions					
	A	B	C	d	E	F	G	H	J
ST-Z0002 ST-Z0003 ST-Z0004 ST-Z0005	4x M2,5/ Ø 3.2	Ø 22.9 + 0.2	□ 22.6 ± 0.1	Ø 21.6	□ 22.6 ± 0.1	4x M3/ Ø 2.7	M2,5	□ 28.0 ± 0.1	5
RF-Z0003	4x Ø 3.2	Ø 27.9 ± 0.1	□ 28.3 ± 0.1	Ø 26.2	□ 28.3 ± 0.1	4x M3	M3	□ 35.0	6
SM-Z0003 SM-Z0004	4x M4/ Ø 4.2	Ø 46.1 ± 0.1	□ 42.4 ± 0.1	Ø 45.0	□ 42.4 ± 0.1	4x Ø 4.3	M3	□ 55.0 ± 0.1	5.5

Note:
For insulating wall mounting, plastic mounting flanges are available on request.

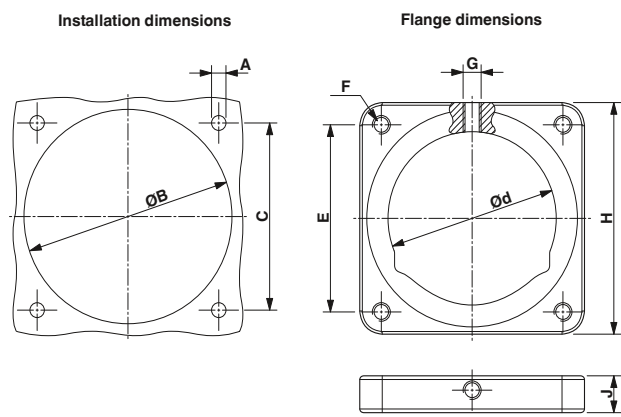

Color rings

The color rings are used for individually marking the connectors



Color rings for marking connectors with cable entry



Color rings for marking device connectors

		Ordering data			Ordering data		
Description	Color	Type	Order No.	Pcs./Pkt.	Type	Order No.	Pcs./Pkt.
Color rings for M17 connectors, 50 pcs. in set							
	green	ST-Z0016	1617993	50	ST-Z0019	1620621	50
	orange	ST-Z0017	1618049	50	ST-Z0020	1620622	50
	black	ST-Z0018	1618050	50	ST-Z0021	1620623	50
Color rings for M23 signal connectors, 50 pcs. in set							
	green	RF-Z0014	1620588	50			
	orange	RF-Z0015	1620592	50			
	black	RF-Z0016	1620593	50			
Color rings for M23 signal device connectors, front mounting, Pg13.5 and M20 fastening thread/rear mounting, central fastening thread, 50 pcs. in set							
	green				CA-Z0110	1620700	50
	orange				CA-Z0111	1620701	50
	black				CA-Z0112	1620702	50
Color rings for M23 signal device connectors, front mounting, flange dimensions: 25 mm x 25 mm, 50 pcs. in set							
	green				CA-Z0120	1620704	50
	orange				CA-Z0121	1620705	50
	black				CA-Z0122	1620706	50
Color rings for M23 feedback connectors and M23 signal device connectors, angled, rotatable, 50 pcs. in the set							
	green	RF-Z0014	1620588	50	RF-Z0017	1620624	50
	orange	RF-Z0015	1620592	50	RF-Z0018	1620625	50
	black	RF-Z0016	1620593	50	RF-Z0019	1620626	50
Color rings for M23 hybrid and power connectors, 50 pcs. in set							
	green	SF-Z0064	1620585	50	RF-Z0017	1620624	50
	orange	SF-Z0065	1620586	50	RF-Z0018	1620625	50
	black	SF-Z0066	1620587	50	RF-Z0019	1620626	50
Color rings for M40 hybrid and power connectors, 50 pcs. in the set							
	green	SM-Z0025	1620558	50	SM-Z0028	1620627	50
	orange	SM-Z0026	1620559	50	SM-Z0029	1620628	50
	black	SM-Z0027	1620560	50	SM-Z0030	1620629	50

Protective caps, plastic

A range of protective caps is available for signal connectors and power connectors to protect the contact elements in the case of a separate plug connection.

These prevent penetration of dust and humidity.

Plastic protective caps enable IP40 degree of protection when locked into place.



Plastic protective cap

ERIC

		Ordering data		
Description	Degree of protection when locked	Type	Order No.	Pcs./Pkt.
Plastic protective cap, for signal or power connectors, with M17 external thread	IP40	ST-Z0006	1607776	25
Plastic protective cap, for signal or power connectors, with M17 knurled nut (SPEEDCON and standard)	IP40	ST-Z0007	1607777	25
Plastic protective cap, for signal or power connectors, with M17 external thread (M17 COMPACT)	IP40	ST-Z0023	1621049	25
Plastic protective cap, for signal or power connectors, with M17 knurled nut (M17 COMPACT)	IP40	ST-Z0024	1621904	25
Plastic protective cap with lug, for signal or power connectors, with M23 external thread	IP40	SF-Z0019	1607449	25
Plastic protective cap, for signal or power connectors and for hybrid connectors, with M23 knurled nut	IP40	RC-Z2058	1604223	25
Plastic protective cap, for signal or power connectors, with M23 external thread	IP40	RC-Z2059	1604225	25
Plastic protective cap, anti-static, black, for signal or power connectors, with M23 knurled nut	IP40	RC-Z2468	1611796	25
Plastic protective cap, for hybrid connectors, with M23 external thread	IP40	SH-Z2304	1622137	25
Plastic protective cap, anti-static, black, for signal or power connectors, with M23 external thread	IP40	RC-Z2469	1611797	25
Plastic protective cap, for power connectors and for hybrid connectors, with M40 external thread	IP40	SM-Z0001	1605866	25
Plastic protective cap, for signal or power connectors and for hybrid connectors, with M40 external thread	IP40	SM-Z0031	1624199	25
Plastic protective cap, for power connectors, with M58 external thread	IP40	SL-Z0005	1607926	25

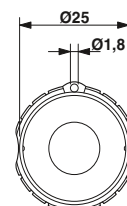

SF-Z0019, eye for fixing cord

Protective caps, metal

Metal protective caps are available for higher demands on the degree of protection. These enable IP67 when locked.

The steel wire is fastened to the housing panel. The metal protective cap is therefore captive.



Metal protective cap

Description	Degree of protection when locked	Ordering data		
		Type	Order No.	Pcs./Pkt.
Metal protective cap , for signal or power connectors, with M17 external thread	IP67	ST-Z0014	1616069	10
Metal protective cap with steel wire and lug , device fastening, for signal or power connectors, with M17 external thread	IP67	ST-Z0013	1616068	10
Metal protective cap with steel wire and loop , cable fastening, for signal or power connectors, with M17 knurled nut	IP67	ST-Z0077	1627217	10
Metal protective cap , for signal connectors, with M23 external thread	IP67	RC-Z2104	1604260	10
Metal protective cap with steel wire and lug , device fastening, for signal connectors, with M23 external thread	IP67	RC-Z2068	1604236	10
Metal protective cap with steel wire and lug , device fastening, for signal connectors, with M23 knurled nut	IP67	RC-Z2062	1604228	10
Metal protective cap with steel wire and loop , cable fastening, for signal connectors, with M23 knurled nut	IP67	CA-Z0077	1627224	1
Metal protective cap , for power connectors, with M23 external thread	IP67	SC-Z2319	1605456	10
Metal protective cap with steel wire and lug , device fastening, for power connectors, with M23 external thread	IP67	SC-Z2320	1605457	10
Metal protective cap , for hybrid and power connectors, with M23 external thread	IP67	SH-Z2301	1622140	10
Metal protective cap with steel wire and lug , device fastening, for hybrid and power connectors, with M23 knurled nut	IP67	SH-Z2300	1622141	10
Metal protective cap with steel wire and loop , cable fastening, for hybrid and power connectors, with M23 knurled nut	IP67	SH-Z0077	1627226	1
Metal protective cap , for hybrid connectors, with M23 external thread	IP67	SH-Z2303	1622138	10
Metal protective cap with steel wire and lug , device fastening, for hybrid connectors, with M23 external thread	IP67	SH-Z2302	1622139	10
Metal protective cap , for hybrid and power connectors, with M40 external thread	IP67	SB-Z0001	1623827	1
Metal protective cap with steel wire and lug , device fastening, for hybrid and power connectors, with M40 external thread	IP67	SB-Z0002	1623828	1
Metal protective cap with steel wire and loop , cable fastening, for hybrid and power connectors, with M40 knurled nut	IP67	SM-Z0077	1627218	1



Sensor/actuator cabling

A one-stop-shop for the entire range of solutions for field installation

In decentral connection technology, passive distributor systems connect the I/O devices to the PLC. Phoenix Contact provides the most comprehensive range of sensor/actuator cabling on the market. Passive M8, and M12 components consisting of distributor boxes, cables, and connectors for assembly are available from stock. A comprehensive selection of valve connectors rounds out the range.

The 1/2" and 7/8" range for the North American market can be found on our website.

Customer and industry-specific solutions

So as to respond flexibly to your requirements, cables and distributor boxes can be individually configured with various cable lengths and types (e.g., other materials or colors).

Phoenix Contact offers a range of suitable product series for increased requirements, such as the railway or food industry, the long-term use of products outdoors and cables for flexible use in drag chains or robot applications.

 Your web code: [#0564](#)

Assembled cables

3-pos. cables with connectors	186
4-pos. cables with connectors	194
5-pos. cables with connectors	200
6-pos. cables with connectors	205
8-pos. cables with connectors	207
12 and 17-pos. cables with connectors	212
Assembled M17 to M40 cables	216
Cables with valve connectors	228

Distributors and adapters	248
----------------------------------	------------

Distributor boxes	260
--------------------------	------------

Cabling for the railway industry	268
---	------------

Cabling for the food industry	270
--------------------------------------	------------

Cabling for outdoor applications	272
---	------------

Cabling for robots and drag chains	274
---	------------

M12 cabling for power applications	276
---	------------

By the meter – cable coils, cable drums	302
--	------------

Accessories	306
--------------------	------------

Cable range	318
--------------------	------------

Sensor/actuator cabling

Assembled cables

M8 SAC cable, snap-in, 3- and 4-pos., cable type: PUR

Notes:
For information about the cable qualities, see page 318

Free end



M12 male connector, 3-pos.

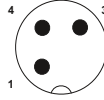

Ordering data

Ordering data

Ordering data

M8 female connector, snap-in, 3-pos., straight

Order No.

Order No.

Order No.



5 m [1519875](#)
Variable [1697593](#)

Variable [1696853](#)

M8 female connector, snap-in, 3-pos., angled



5 m [1519891](#)
Variable [1697629](#)

Variable [1696882](#)

M8 female connector, snap-in, 3-pos., with LEDs, angled



Variable [1513402](#)

Variable [1515675](#)

M8 female connector, snap-in, 4-pos., straight



Variable [1513389](#)

M8 female connector, snap-in, 4-pos., angled



Variable [1513392](#)

M8 female connector, snap-in, 4-pos., with LEDs, angled



Variable [1511954](#)

Information for products with fixed cable length:

Products with fixed cable length are produced with the halogen-free PUR cable type and are available from stock.

Ordering data for products with variable cable:

For a 4.5 m long sensor/actuator cable, PUR, halogen-free, black, with a straight 3-pos. M12 male and a straight M8 snap-in female, the ordering data is as follows:

Order No.	Cable type	Length [m] 40 m, maximum
1696853	PUR	4.5
Minimum order amount:		Increments:
25 pcs.		0.2 ... 3 m = 0.1 m
		> 3 m = 0.5 m

Cable description	Cable type	Suitable for
PUR, halogen-free – black E221474	PUR	3-/4-pos.
PUR, halogen-free – gray E221474	280	3-pos.
TPE-U highly flexible – gray E221474	800	3-/4-pos.

Color coding	Pin assignment 3-pos.
BN	1
BK	4
BU	3

Color coding	Pin assignment 4-pos.
BN	1
WH	2
BK	4
BU	3

With a combination of M12 and M8 connectors, the limiting M8 value applies to the rated voltage.

	Technical data	Technical data	Technical data	Technical data
	M8 3-pos.	M8 3-pos., with LEDs	M8 4-pos.	M8 4-pos., with LED
Rated voltage	48 V AC / 60 V DC	24 V / 24 V DC	48 V AC / 60 V DC	24 V / 24 V DC
Rated current [A]	4	4	4	4
Contact material	CuSn	CuSn	CuSn	CuSn
Contact surface material	Ni/Au	Ni/Au	Ni/Au	Ni/Au
Material of grip body	TPU, hardly inflammable, self-extinguishing	TPU, hardly inflammable, self-extinguishing	TPU, hardly inflammable, self-extinguishing	TPU, hardly inflammable, self-extinguishing
M8 circular connector in accordance with:	IEC 61076-2-104	IEC 61076-2-104	IEC 61076-2-104	IEC 61076-2-104
Degree of protection	IP65 / IP67 / IP68	IP65 / IP67 / IP68	IP65 / IP67 / IP68	IP65 / IP67 / IP68
Temperature data				
Male connector/female connector [°C]	-25 ... 90	-25 ... 90	-25 ... 90	-25 ... 90

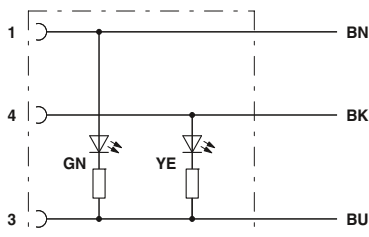

Contact assignment of the M8 female connector with LED, 3-pos.

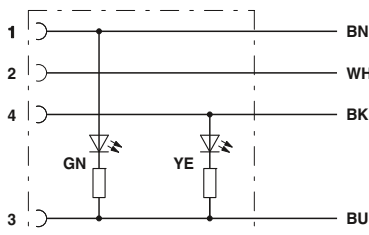

Contact assignment of the M8 female connector with LED, 4-pos.

Sensor/actuator cabling

Assembled cables

M8 and M12 SAC cable, 3-pos., cable type: PUR

Notes:
For information about the cable qualities, see page 318

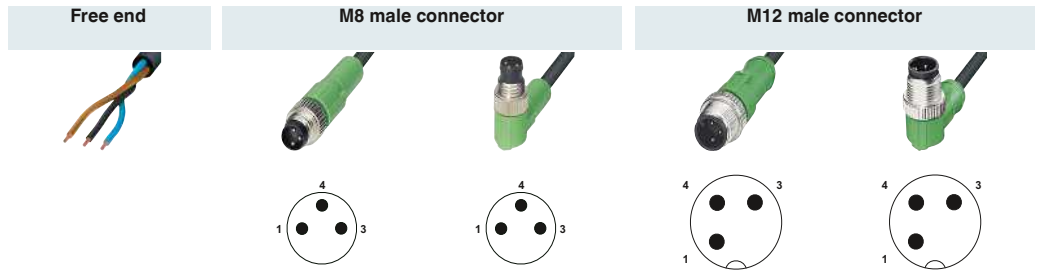

	Ordering data	Ordering data	Ordering data	Ordering data	Ordering data
Free end	Order No.	Order No.	Order No.	Order No.	Order No.
		1.5 m 1681664	1.5 m 1681693	1.5 m 1668014	1.5 m 1668137
		3 m 1681677	3 m 1681703	3 m 1668027	3 m 1668140
		5 m 1681680	5 m 1681716	5 m 1668030	5 m 1668153
		10 m 1693584	10 m 1694114	10 m 1682566	10 m 1694444
		Variable 1697548	Variable 1697551	Variable 1696662	Variable 1696675
M8 female connector, straight		0.3 m 1681907	0.3 m 1682029	0.3 m 1668797	0.3 m 1668878
	1.5 m 1669712	0.6 m 1681910	0.6 m 1682032	0.6 m 1668807	0.6 m 1668881
	3 m 1669725	1.5 m 1681923	1.5 m 1682045	1.5 m 1668810	1.5 m 1668894
	5 m 1669628	3 m 1681936	3 m 1682058	3 m 1668823	3 m 1668904
	10 m 1694101	Variable 1697632	Variable 1697661	Variable 1696840	Variable 1696895
	Variable 1697580				
M8 female connector, angled		0.3 m 1681949	0.3 m 1682061	0.3 m 1668836	0.3 m 1668917
	1.5 m 1669738	0.6 m 1681952	0.6 m 1682074	0.6 m 1668849	0.6 m 1668920
	3 m 1669741	1.5 m 1681965	1.5 m 1682087	1.5 m 1668852	1.5 m 1668933
	5 m 1669631	3 m 1681978	3 m 1682090	3 m 1668865	3 m 1668946
	10 m 1694169	Variable 1697645	Variable 1697674	Variable 1696866	Variable 1696905
	Variable 1697603				
M8 female connector, angled, with 2 LEDs		0.3 m 1681981	0.3 m 1682100	0.3 m 1694884	
	1.5 m 1671069	0.6 m 1681994	0.6 m 1682113	0.6 m 1694897	
	3 m 1671072	1.5 m 1682003	1.5 m 1682126	1.5 m 1694907	
	5 m 1671085	3 m 1682016	3 m 1682139	3 m 1694910	
	10 m 1683594	Variable 1697658	Variable 1697687	Variable 1696879	Variable 1696918
	Variable 1697616				
M12 female connector, straight		0.3 m 1682304	0.3 m 1682388	0.3 m 1681509	
	1.5 m 1694486	0.6 m 1682317	0.6 m 1682391	0.6 m 1681512	
	3 m 1694499	1.5 m 1682320	1.5 m 1682401	1.5 m 1681525	
	5 m 1683510	3 m 1682333	3 m 1682414	3 m 1681538	
	10 m 1693034	Variable 1697690	Variable 1697726	Variable 1696756	
	Variable 1696688				
M12 female connector, straight, pin 2 - 4 bridged				0.3 m 1668315	0.3 m 1668551
	1.5 m 1668072			0.6 m 1668328	0.6 m 1668564
	3 m 1668085			1.5 m 1668331	1.5 m 1668577
	5 m 1668098			3 m 1668344	3 m 1668580
	10 m 1694208			Variable 1696769	Variable 1696811
	Variable 1696691				
M12 female connector, straight, with LED					
	1.5 m 1694185				
	3 m 1694198				
	5 m 1694787				
	10 m 1694790	Variable 1514197		Variable 1511802	Variable 1524763
	Variable 1696701				
M12 female connector, angled		0.3 m 1682346	0.3 m 1682427	0.3 m 1681541	
	1.5 m 1694509	0.6 m 1682359	0.6 m 1682430	0.6 m 1681554	
	3 m 1694512	1.5 m 1682362	1.5 m 1682443	1.5 m 1681567	
	5 m 1694525	3 m 1682375	3 m 1682456	3 m 1681570	
	10 m 1694538	Variable 1697700	Variable 1697739	Variable 1696772	
	Variable 1696714				
M12 female connector, angled, pin 2 - 4 bridged				0.3 m 1668399	0.3 m 1668632
	1.5 m 1668195			0.6 m 1668409	0.6 m 1668645
	3 m 1668205			1.5 m 1668412	1.5 m 1668658
	5 m 1668218			3 m 1668425	3 m 1668661
	10 m 1681017			Variable 1696785	Variable 1696824
	Variable 1696727				
M12 female connector, angled with LED					
	1.5 m 1694392	0.3 m 1693351	0.3 m 1682469	0.3 m 1694554	
	3 m 1694402	0.6 m 1693364	0.6 m 1682472	0.6 m 1694567	
	5 m 1694415	1.5 m 1693380	1.5 m 1682485	1.5 m 1694570	
	10 m 1694428	3 m 1693403	3 m 1682498	3 m 1694583	
	Variable 1696730	Variable 1697713	Variable 1697742	Variable 1696798	
M12 female connector, angled, with LED, pin 2 - 4 bridged					
	1.5 m 1668250			0.3 m 1668438	
	3 m 1668263			0.6 m 1668441	
	5 m 1668276			1.5 m 1668454	
	10 m 1681059			3 m 1668467	
	Variable 1696743			Variable 1696808	Variable 1696837

Information for products with fixed cable length:

Products with fixed cable length are produced with the halogen-free PUR cable type and are available from stock.

Ordering data for products with variable cable:

For a 4.5 m long sensor/actuator cable, PUR, halogen-free, black, with a straight 3-pos. M12 male and a straight M12 female, the ordering data is as follows:

Order No.	Cable type	Length [m] 40 m, maximum
1696756	PUR	4.5
Minimum order amount: 25 pcs.		Increments: 0.2 ... 3 m = 0.1 m > 3 m = 0.5 m

Cable description	Cable type	Suitable for:
PUR, halogen-free – black E221474	PUR	M8/M12
PUR, halogen-free – gray E221474	280	M8/M12
TPE-U highly flexible – gray E221474	800	M8/M12
PUR irradiated – orange E221474	150	M12
PVC – black E221474	PVC	M8/M12
PVC – gray E221474	500	M8/M12
PVC – yellow E221474	540	M12
PVC 105° – yellow E221474	542	M12

Color coding	Pin assignment
BN	1
BK	4
BU	3

With a combination of M12 and M8 connectors, the limiting M8 value applies to the rated voltage.

	Technical data	Technical data	Technical data	Technical data
	M8 3-pos.	M8 3-pos., with LEDs	M12 3-pos.	M12 3-pos., with LEDs
Rated voltage	48 V AC / 60 V DC	24 V / 24 V DC	250 V AC / 250 V DC	24 V / 24 V DC
Rated current [A]	4	4	4	4
Contact material	CuSn	CuSn	CuSn	CuSn
Contact surface material	Ni/Au	Ni/Au	Ni/Au	Ni/Au
Material of grip body	TPU, hardly inflammable, self-extinguishing	TPU, hardly inflammable, self-extinguishing	TPU, hardly inflammable, self-extinguishing	TPU, hardly inflammable, self-extinguishing
M8 circular connector in accordance with:	IEC 61076-2-104	IEC 61076-2-104	IEC 61076-2-101	IEC 61076-2-101
M12 circular connector in accordance with:	-	-	IEC 61076-2-101	IEC 61076-2-101
Degree of protection	IP65 / IP67 / IP68	IP65 / IP67 / IP68	IP65 / IP67 / IP68	IP65 / IP67 / IP68
Temperature data				
Male connector/female connector [°C]	-25 ... 90	-25 ... 90	-25 ... 90	-25 ... 90

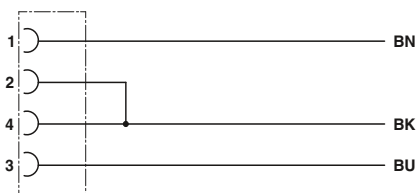

Contact assignment of M12 female connectors, bridged

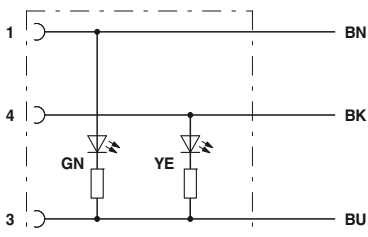

Contact assignment of M8/M12 female connectors with two LEDs

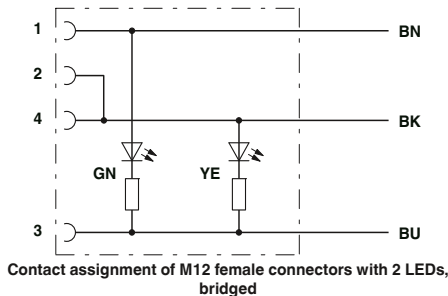

Contact assignment of M12 female connectors with 2 LEDs, bridged

Sensor/actuator cabling

Assembled cables

M8 and M12 SAC cable, 3-pos., cable type: PVC

Notes:
For information about the cable qualities, see page 318

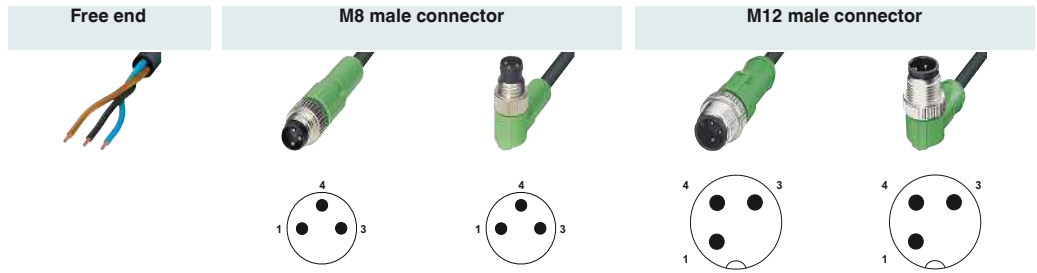

Free end	Ordering data		Ordering data		Ordering data		Ordering data		Ordering data		
	Order No.		Order No.		Order No.		Order No.		Order No.		
			1.5 m	1415861	1.5 m	1415865	1.5 m	1414434	1.5 m	1414447	
			3 m	1415862	3 m	1415866	3 m	1414435	3 m	1414448	
			5 m	1415863	5 m	1415867	5 m	1693173	5 m	1414449	
			10 m	1447280	10 m	1415869	10 m	1414437	10 m	1414450	
			Variable	1697548	Variable	1697551	Variable	1696662	Variable	1696675	
M8 female connector, straight											
		1.5 m	1415870	0.3 m	1415877	0.3 m	1415881	0.3 m	1415525	0.3 m	1415534
		3 m	1415871	0.6 m	1415878	0.6 m	1415882	0.6 m	1415527	0.6 m	1415535
		5 m	1510748	1.5 m	1415879	1.5 m	1415883	1.5 m	1415528	1.5 m	1415536
		10 m	1506532	3 m	1415880	3 m	1415884	3 m	1415529	3 m	1415537
		Variable	1697580	Variable	1697632	Variable	1697661	Variable	1696840	Variable	1696895
M8 female connector, angled											
		1.5 m	1415872	0.3 m	1415886	0.3 m	1415891	0.3 m	1415530	0.3 m	1415538
		3 m	1446320	0.6 m	1415888	0.6 m	1415892	0.6 m	1415531	0.6 m	1415539
		5 m	1403253	1.5 m	1415889	1.5 m	1415893	1.5 m	1415532	1.5 m	1415540
		10 m	1403773	3 m	1415890	3 m	1415894	3 m	1415533	3 m	1415541
		Variable	1697603	Variable	1697645	Variable	1697674	Variable	1696866	Variable	1696905
M8 female connector, angled, with 2 LEDs											
		1.5 m	1415874	0.3 m	1415896	0.3 m	1415901				
		3 m	1415875	0.6 m	1415897	0.6 m	1415902				
		5 m	1508174	1.5 m	1415898	1.5 m	1415903				
		10 m	1415876	3 m	1415899	3 m	1415904				
		Variable	1697616	Variable	1697658	Variable	1697687	Variable	1696879	Variable	1696918
M12 female connector, straight											
		1.5 m	1414451					0.3 m	1414576		
		3 m	1414452					0.6 m	1414577		
		5 m	1400505					1.5 m	1414578		
		10 m	1403486					3 m	1414579		
		Variable	1696688	Variable	1697690	Variable	1697726	Variable	1696756		
M12 female connector, straight, pin 2 - 4 bridged											
		Variable	1696691					Variable	1696769	Variable	1696811
M12 female connector, straight, with 2 LEDs											
		1.5 m	1414556								
		3 m	1414561								
		5 m	1508459								
		10 m	1414565								
		Variable	1696701	Variable	1514197			Variable	1511802	Variable	1524763
M12 female connector, angled											
		1.5 m	1414552					0.3 m	1414580		
		3 m	1414553					0.6 m	1414581		
		5 m	1579051					1.5 m	1415519		
		10 m	1453821					3 m	1415520		
		Variable	1696714	Variable	1697700	Variable	1697739	Variable	1696772		
M12 female connector, angled, pin 2 - 4 bridged											
		Variable	1696727					Variable	1696785	Variable	1696824
M12 female connector, angled, with 2 LEDs											
		1.5 m	1414571					0.3 m	1415521		
		3 m	1414573					0.6 m	1415522		
		5 m	1505326					1.5 m	1415523		
		10 m	1414575					3 m	1415524		
		Variable	1696730	Variable	1697713	Variable	1697742	Variable	1696798		
M12 female connector, angled, with LED, pin 2 - 4 bridged											
		Variable	1696743					Variable	1696808	Variable	1696837

Information for products with fixed cable length:

Products with fixed cable length are produced with the PVC cable type and are available from stock.

Ordering data for products with variable cable:

For a 4.5 m long sensor/actuator cable, PVC - black, with a straight 3-pos. M12 male and a straight M12 female, the ordering data is as follows:

Order No.	Cable type	Length [m] 40 m, maximum
1696756	PVC	4.5
Minimum order amount: 25 pcs.		Increments: 0.2 ... 3 m = 0.1 m > 3 m = 0.5 m

Cable description	Cable type	Suitable for:
PVC – black E221474	PVC	M8/M12
PVC – gray E221474	500	M8/M12
PVC – yellow E221474	540	M12
PVC 105° – yellow E221474	542	M12
PUR, halogen-free – black E221474	PUR	M8/M12
PUR irradiated – orange E221474	150	M12
PUR, halogen-free – gray E221474	280	M8/M12
TPE-U highly flexible – gray E221474	800	M8/M12

Color coding	Pin assignment
BN	1
BK	4
BU	3

With a combination of M12 and M8 connectors, the limiting M8 value applies to the rated voltage.

	Technical data	Technical data	Technical data	Technical data
	M8 3-pos.	M8 3-pos., with LEDs	M12 3-pos.	M12 3-pos., with LEDs
Rated voltage	48 V AC / 60 V DC	24 V / 24 V DC	250 V AC / 250 V DC	24 V / 24 V DC
Rated current [A]	4	4	4	4
Contact material	CuSn	CuSn	CuSn	CuSn
Contact surface material	Ni/Au	Ni/Au	Ni/Au	Ni/Au
Material of grip body	TPU, hardly inflammable, self-extinguishing	TPU, hardly inflammable, self-extinguishing	TPU, hardly inflammable, self-extinguishing	TPU, hardly inflammable, self-extinguishing
M8 circular connector in accordance with:	IEC 61076-2-104	IEC 61076-2-104	IEC 61076-2-101	IEC 61076-2-101
M12 circular connector in accordance with:	-	-	-	-
Degree of protection	IP65 / IP67 / IP68	IP65 / IP67 / IP68	IP65 / IP67 / IP68	IP65 / IP67 / IP68
Temperature data	-25 ... 90	-25 ... 90	-25 ... 90	-25 ... 90
Male connector/female connector	[°C]	[°C]	[°C]	[°C]

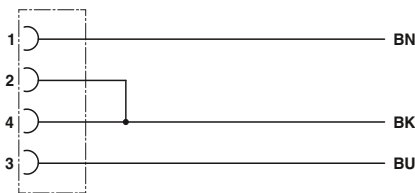

Contact assignment of M12 female connectors, bridged

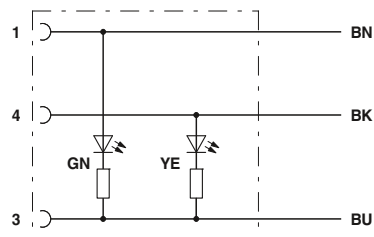

Contact assignment of M8/M12 female connectors with two LEDs

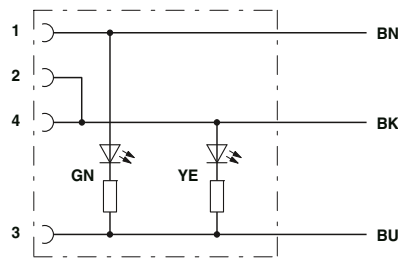

Contact assignment of M12 female connectors with 2 LEDs, bridged

Sensor/actuator cabling

Assembled cables

M12 SAC cable, 3-pos., cable type: 800

Notes:
For information about the cable qualities, see page 324

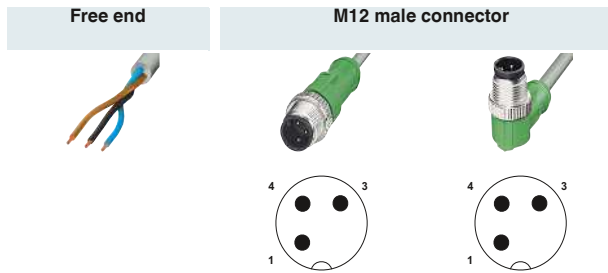

Free end	Ordering data		Ordering data		Ordering data	
	Order No.		Order No.		Order No.	
		1.5 m	1456734	1.5 m	1456899	
		3 m	1456747	3 m	1456909	
		5 m	1456750	5 m	1456912	
		10 m	1456763	10 m	1456925	
		Variable	1696662	Variable	1696675	
M12 female connector, straight 		1.5 m	1456679	0.3 m	1456776	
		3 m	1456682	0.6 m	1456789	
		5 m	1456695	1.5 m	1456792	
		10 m	1456705	3 m	1456802	
		Variable	1696688	Variable	1696756	
M12 female connector, angled 		1.5 m	1454260	0.3 m	1456815	
		3 m	1456718	0.6 m	1456828	
		5 m	1454273	1.5 m	1456831	
		10 m	1454299	3 m	1456844	
		Variable	1696714	Variable	1696772	
M12 female connector, angled, with 2 LEDs 		1.5 m	1454312	0.3 m	1456857	
		3 m	1456721	0.6 m	1456860	
		5 m	1454325	1.5 m	1456873	
		10 m	1454341	3 m	1456886	
		Variable	1696730	Variable	1696798	

Information for products with fixed cable length:

Products with fixed cable length are produced with the highly flexible 800 cable type and are available from stock.

Cable description	Cable type	Color coding	Pin assignment
TPE-U highly flexible – gray Robots and drag chains	800	BN BK BU	1 4 3

Ordering data for products with variable cable:

For a 4.5 m long sensor/actuator cable, TPE-U 800, with a straight 3-pos. M12 connector and free cable end, the ordering data is as follows:

Order No.	Cable type	Length [m]
1696662	800	4.5
Minimum order amount:		Increments:
25 pcs.		0.2 ... 3 m = 0.1 m
		> 3 m = 0.5 m

	Technical data	Technical data
	M12 3-pos.	M12 3-pos., with LEDs
Rated voltage	250 V AC / 250 V DC	24 V / 24 V DC
Rated current [A]	4	4
Contact material	CuSn	CuSn
Contact surface material	Ni/Au	Ni/Au
Material of grip body	TPU, hardly inflammable, self-extinguishing	TPU, hardly inflammable, self-extinguishing
Material, knurls	Zinc die-cast, nickel-plated	Zinc die-cast, nickel-plated
M12 circular connector in accordance with:	IEC 61076-2-101	IEC 61076-2-101
Degree of protection	IP65 / IP67 / IP68	IP65 / IP67 / IP68
Temperature data		
Male connector/female connector	-25 ... 90 [°C]	-25 ... 90

M8 and M12 SAC cable, 3-pos., shielded, cable type: PUR

Notes:
For information about the cable qualities, see page 318

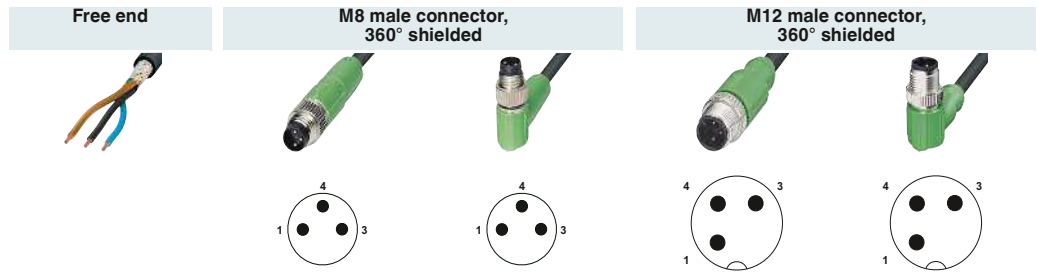

	Ordering data		Ordering data		Ordering data		Ordering data		
	Order No.	Order No.	Order No.	Order No.	Order No.	Order No.	Order No.	Order No.	
Free end		1.5 m 3 m 5 m 10 m Variable	1521614 1521527 1521630 1521643 1521656	1.5 m 3 m 5 m 10 m Variable	1521669 1521672 1521685 1521698 1521708	1.5 m 3 m 5 m 10 m Variable	1682650 1682663 1682676 1500664 1697425	1.5 m 3 m 5 m 10 m Variable	1682689 1682692 1682702 1500677 1697438
M8 female connector, straight, 360° shielded		1.5 m 3 m 5 m 10 m Variable	1521711 1521724 1521737 1521740 1521753	0.3 m 0.6 m 1.5 m 3 m Variable	1456310 1456323 1455285 1455298 1552052	Variable	1552078		
M8 female connector, angled, 360° shielded		1.5 m 3 m 5 m 10 m Variable	1521766 1521779 1521782 1521795 1521805	Variable	1552065	Variable	1552081		
M12 female connector, straight, 360° shielded		1.5 m 3 m 5 m 10 m Variable	1682786 1682799 1682809 1500680 1697441			0.3 m 0.6 m 1.5 m 3 m Variable	1500800 1500813 1500826 1500839 1536049	Variable	1536065
M12 female connector, angled, 360° shielded		1.5 m 3 m 5 m 10 m Variable	1682812 1682825 1682838 1500693 1697454			0.3 m 0.6 m 1.5 m 3 m Variable	1500923 1500936 1500949 1500952 1536052	Variable	1536078

Information for products with fixed cable length:

Products with fixed cable length are produced with the halogen-free PUR cable type and are available from stock.

Cable description	Cable type	Suitable for:
PUR, halogen-free – black E221474	PUR	M8/M12
PVC – black E221474	PVC	M12
PVC – gray E221474	500	M12

Color coding	Pin assignment
BN	1
BK	4
BU	3

Ordering data for products with variable cable:

For a 4.5 m long shielded sensor/actuator cable, PUR, halogen-free, black, with a straight 3-pos. M12 male and a straight M12 female, the ordering data is as follows:

Order No.	Cable type	Length [m]
1536049	PUR	4.5
Minimum order amount:		25 pcs.
Increments:		0.2 ... 3 m = 0.1 m > 3 m = 0.5 m

With a combination of M12 and M8 connectors, the limiting M8 value applies to the rated voltage.

	Technical data	Technical data
	M8 3-pos., shielded	M12 3-pos., shielded
Rated voltage	48 V AC / 60 V DC	48 V AC / 60 V DC
Rated current	4 [A]	4
Contact material	CuSn	CuSn
Contact surface material	Ni/Au	Ni/Au
Material of grip body	TPU, hardly inflammable, self-extinguishing	TPU, hardly inflammable, self-extinguishing
M8 circular connector in accordance with:	IEC 61076-2-104	-
M12 circular connector in accordance with:	-	IEC 61076-2-101
Degree of protection	IP65 / IP67	IP65 / IP67
Temperature data		
Male connector/female connector	-25 ... 90 [°C]	-25 ... 90

Sensor/actuator cabling

Assembled cables

M8 and M12 SAC cable, 4-pos., cable type: PUR

Notes:
For information about the cable qualities, see page 318

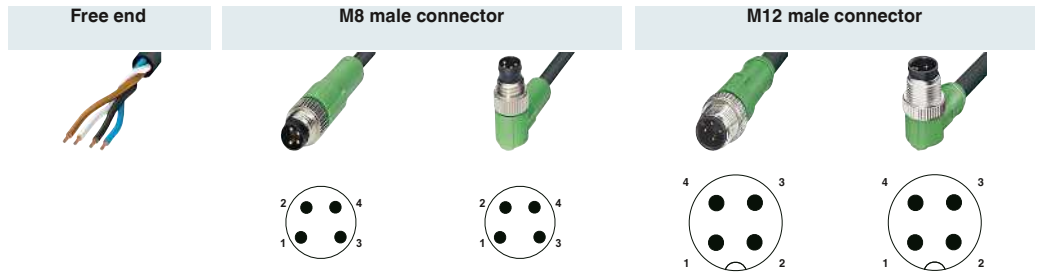

	Ordering data		Ordering data		Ordering data		Ordering data		Ordering data	
Free end	Order No.	Order No.	Order No.	Order No.	Order No.	Order No.	Order No.	Order No.	Order No.	
		1.5 m 1681787	1.5 m 1681813	1.5 m 1668043	1.5 m 1668166					
		3 m 1681790	3 m 1681826	3 m 1668056	3 m 1668179					
		5 m 1681800	5 m 1681839	5 m 1668069	5 m 1668182					
		10 m 1694143	10 m 1694156	10 m 1682993	10 m 1694457					
		Variable 1697755	Variable 1697768	Variable 1696947	Variable 1696950					
M8 female connector, straight										
		1.5 m 1681842	0.3 m 1682142	0.3 m 1682223	0.3 m 1694923					
		3 m 1681855	0.6 m 1682155	0.6 m 1682236	0.6 m 1693076					
		5 m 1681868	1.5 m 1682168	1.5 m 1682249	1.5 m 1693089					
		10 m 1683484	3 m 1682171	3 m 1682252	3 m 1694936					
		Variable 1697771	Variable 1697797	Variable 1697810	Variable 1697072	Variable 1507874				
M8 female connector, angled										
		1.5 m 1681871	0.3 m 1682184	0.3 m 1682265		0.3 m 1671551				
		3 m 1681884	0.6 m 1682197	0.6 m 1682278		0.6 m 1671564				
		5 m 1681897	1.5 m 1682207	1.5 m 1682281		1.5 m 1671577				
		10 m 1694172	3 m 1682210	3 m 1682294		3 m 1671580				
		Variable 1697784	Variable 1697807	Variable 1697823	Variable 1697085					
M8 female connector, angled, with 2 LEDs										
		Variable 1517673			Variable 1515031					
M12 female connector, straight										
		1.5 m 1668108			0.3 m 1668357	0.3 m 1668593				
		3 m 1668111			0.6 m 1668360	0.6 m 1668603				
		5 m 1668124			1.5 m 1668373	1.5 m 1668616				
		10 m 1683002			3 m 1668386	3 m 1668629				
		Variable 1696963	Variable 1506697		Variable 1697001	Variable 1697030				
M12 female connector, straight, with 2 LEDs										
		1.5 m 1694800								
		3 m 1694813								
		5 m 1694826								
		10 m 1694839								
		Variable 1696976								
M12 female connector, angled										
		1.5 m 1668221			0.3 m 1668470	0.3 m 1668713				
		3 m 1668234			0.6 m 1668483	0.6 m 1668726				
		5 m 1668247			1.5 m 1668496	1.5 m 1668739				
		10 m 1681389			3 m 1668506	3 m 1668742				
		Variable 1696989	Variable 1511718	Variable 1697836	Variable 1697014	Variable 1697043				
M12 female connector, angled, with 3 LEDs										
		1.5 m 1668289			0.3 m 1668519	0.3 m 1668755				
		3 m 1668292			0.6 m 1668522	0.6 m 1668768				
		5 m 1668302			1.5 m 1668535	1.5 m 1668771				
		10 m 1681020			3 m 1668548	3 m 1668784				
		Variable 1696992			Variable 1697027	Variable 1697056				

Information for products with fixed cable length:

Products with fixed cable length are produced with the halogen-free PUR cable type and are available from stock.

Ordering data for products with variable cable:

For a 4.5 m long sensor/actuator cable, PUR, halogen-free, black, with a straight 4-pos. M12 male and a straight M12 female, the ordering data is as follows:

Order No.	Cable type	Length [m] 40 m, maximum
1697001	PUR	4.5
Minimum order amount: 25 pcs.		
Increments: 0.2 ... 3 m = 0.1 m > 3 m = 0.5 m		

Cable description	Cable type	Suitable for:	Color coding	Pin assignment
PUR, halogen-free – black E221474	PUR	M8/M12	BN	1
PUR, halogen-free – yellow E221474	240	M12	WH	2
PUR, halogen-free – gray E221474	280	M8/M12	BK	4
TPE-U highly flexible – gray E221474	800	M8/M12	BU	3
PUR irradiated – orange E221474	150	M12		
PUR irradiated – yellow E221474	160	M12		
PVC – black E221474	PVC	M8/M12		
PVC – gray E221474	500	M8/M12		
PVC – yellow E221474	540	M12		
PVC 105° – yellow E221474	542	M12		

With a combination of M12 and M8 connectors, the limiting M8 value applies to the rated voltage.

	Technical data	Technical data	Technical data	Technical data
	M8 4-pos.	M8 4-pos., with LED	M12 4-pos.	M12 4-pos., with LED
Rated voltage	48 V AC / 60 V DC	24 V / 24 V DC	250 V AC / 250 V DC	24 V / 24 V DC
Rated current [A]	4	4	4	4
Contact material	CuSn	CuSn	CuSn	CuSn
Contact surface material	Ni/Au	Ni/Au	Ni/Au	Ni/Au
Material of grip body	TPU, hardly inflammable, self-extinguishing	TPU, hardly inflammable, self-extinguishing	TPU, hardly inflammable, self-extinguishing	TPU, hardly inflammable, self-extinguishing
M8 circular connector in accordance with:	IEC 61076-2-104	IEC 61076-2-104	-	-
M12 circular connector in accordance with:	-	-	IEC 61076-2-101	IEC 61076-2-101
Degree of protection	IP65 / IP67 / IP68	IP65 / IP67 / IP68	IP65 / IP67 / IP68	IP65 / IP67 / IP68
Temperature data				
Male connector/female connector [°C]	-25 ... 90	-25 ... 90	-25 ... 90	-25 ... 90

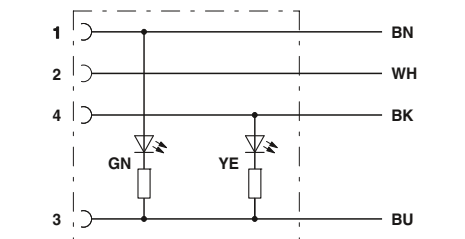

Contact assignment of M8/M12 female connectors with LED

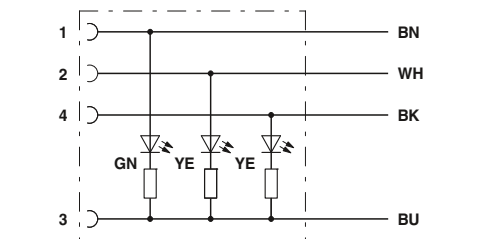

Contact assignment of M12 female connectors with LED

Sensor/actuator cabling

Assembled cables

M8 and M12 SAC cable, 4-pos., cable type: PVC

Notes:
For information about the cable qualities, see page 318

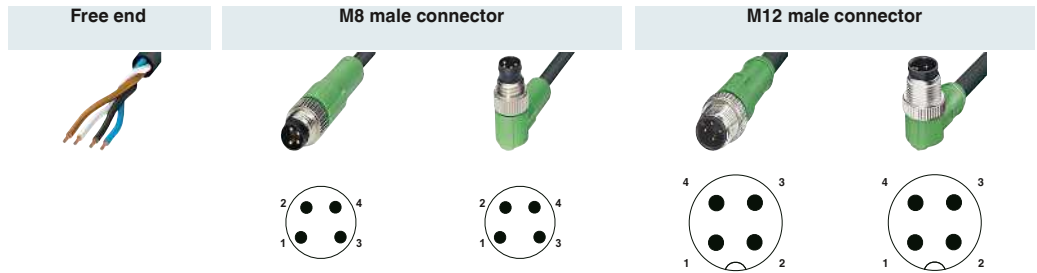

	Ordering data		Ordering data		Ordering data		Ordering data		Ordering data	
Free end	Order No.	Order No.	Order No.	Order No.	Order No.	Order No.	Order No.	Order No.	Order No.	
	1.5 m	1415542	1.5 m	1415546	1.5 m	1415585	1.5 m	1415591		
	3 m	1415543	3 m	1415547	3 m	1415588	3 m	1415592		
	5 m	1415544	5 m	1415548	5 m	1415589	5 m	1415593		
	10 m	1415545	10 m	1415549	10 m	1415590	10 m	1415594		
	Variable	1697755	Variable	1697768	Variable	1696947	Variable	1696950		
M8 female connector, straight										
	1.5 m	1415550	0.3 m	1415556	0.3 m	1415576	0.3 m	1415671		
	3 m	1415551	0.6 m	1415557	0.6 m	1415577	0.6 m	1415672		
	5 m	1403252	1.5 m	1415558	1.5 m	1415578	1.5 m	1415673		
	10 m	1401062	3 m	1415560	3 m	1415579	3 m	1415674		
	Variable	1697771	Variable	1697797	Variable	1697810	Variable	1697072	Variable	
									1507874	
M8 female connector, angled										
	1.5 m	1415552	0.3 m	1415562	0.3 m	1415580		0.3 m	1415667	
	3 m	1415554	0.6 m	1415572	0.6 m	1415581		0.6 m	1415668	
	5 m	1403254	1.5 m	1415573	1.5 m	1415582		1.5 m	1415669	
	10 m	1401064	3 m	1415574	3 m	1415583		3 m	1415670	
	Variable	1697784	Variable	1697807	Variable	1697823	Variable	1697085		
M8 female connector, angled, with 2 LEDs										
	Variable	1517673					Variable	1515031		
M12 female connector, straight										
	1.5 m	1544976				0.3 m	1415611	0.3 m	1415627	
	3 m	1404407				0.6 m	1415612	0.6 m	1415628	
	5 m	1404408				1.5 m	1415613	1.5 m	1415635	
	10 m	1446333				3 m	1415614	3 m	1415636	
	Variable	1696963	Variable	1506697		Variable	1697001	Variable	1697030	
M12 female connector, straight, with 2 LEDs										
	1.5 m	1415596								
	3 m	1415597								
	5 m	1415602								
	10 m	1415605								
	Variable	1696976								
M12 female connector, angled										
	1.5 m	1415606				0.3 m	1415617	0.3 m	1415642	
	3 m	1693526				0.6 m	1454817	0.6 m	1415643	
	5 m	1693539				1.5 m	1415618	1.5 m	1415644	
	10 m	1415608				3 m	1415619	3 m	1415645	
	Variable	1696989	Variable	1511718	Variable	1697836	Variable	1697014	Variable	
									1697043	
M12 female connector, angled, with 3 LEDs										
	1.5 m	1415609				0.3 m	1415620	0.3 m	1415646	
	3 m	1415610				0.6 m	1415623	0.6 m	1415647	
	5 m	1404961				1.5 m	1415624	1.5 m	1415648	
	10 m	1401063				3 m	1415625	3 m	1415650	
	Variable	1696992				Variable	1697027	Variable	1697056	

Information for products with fixed cable length:

Products with fixed cable length are produced with the PVC cable type and are available from stock.

Ordering data for products with variable cable:

For a 4.5 m long sensor/actuator cable, PVC - black, with a straight 4-pos. M12 male and a straight M12 female, the ordering data is as follows:

Order No.	Cable type	Length [m]
1697001	PVC	4.5
Minimum order amount:		25 pcs.
Increments:		0.2 ... 3 m = 0.1 m > 3 m = 0.5 m

Cable description	Cable type	Suitable for:
PVC – black E221474	PVC	M8/M12
PVC – gray E221474	500	M8/M12
PVC – yellow E221474	540	M12
PVC 105° – yellow E221474	542	M12
PUR, halogen-free – black E221474	PUR	M8/M12
PUR, halogen-free – yellow E221474	240	M12
PUR, halogen-free – gray E221474	280	M8/M12
PUR irradiated – orange E221474	150	M12
PUR irradiated – yellow E221474	160	M12
TPE-U highly flexible – gray E221474	800	M8/M12

Color coding	Pin assignment
BN	1
WH	2
BK	4
BU	3

With a combination of M12 and M8 connectors, the limiting M8 value applies to the rated voltage.

	Technical data	Technical data	Technical data	Technical data
	M8 4-pos.	M8 4-pos., with LED	M12 4-pos.	M12 4-pos., with LED
Rated voltage	48 V AC / 60 V DC	24 V / 24 V DC	250 V AC / 250 V DC	24 V / 24 V DC
Rated current [A]	4	4	4	4
Contact material	CuSn	CuSn	CuSn	CuSn
Contact surface material	Ni/Au	Ni/Au	Ni/Au	Ni/Au
Material of grip body	TPU, hardly inflammable, self-extinguishing	TPU, hardly inflammable, self-extinguishing	TPU, hardly inflammable, self-extinguishing	TPU, hardly inflammable, self-extinguishing
M8 circular connector in accordance with:	IEC 61076-2-104	IEC 61076-2-104	-	-
M12 circular connector in accordance with:	-	-	IEC 61076-2-101	IEC 61076-2-101
Degree of protection	IP65 / IP67 / IP68	IP65 / IP67 / IP68	IP65 / IP67 / IP68	IP65 / IP67 / IP68
Temperature data				
Male connector/female connector [°C]	-25 ... 90	-25 ... 90	-25 ... 90	-25 ... 90

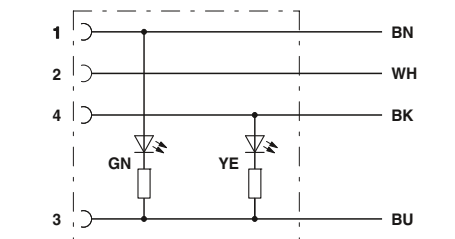

Contact assignment of M8/M12 female connectors with LED

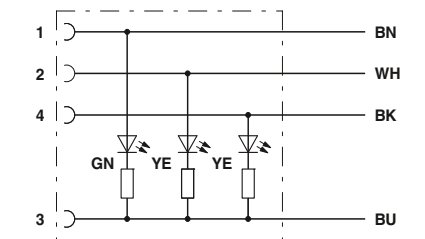

Contact assignment of M12 female connectors with LED

Sensor/actuator cabling

Assembled cables

M12 SAC cable, 4-pos., cable type: 800

Notes:
For information about the cable qualities, see page 324

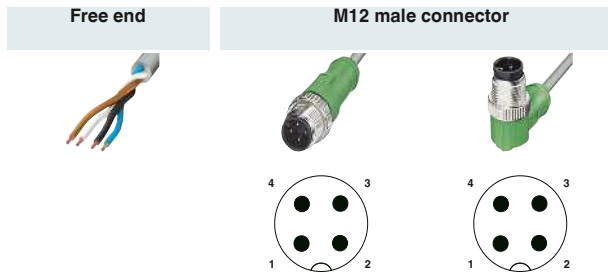

	Ordering data	Ordering data	Ordering data
Free end	Order No.	Order No.	Order No.
	1.5 m	1457018	1.5 m 1457128
	3 m	1457021	3 m 1457131
	5 m	1457034	5 m 1457144
	10 m	1457047	10 m 1457157
	Variable	1696947	Variable 1696950
M12 female connector, straight 	1.5 m	1456938	0.3 m 1457050
	3 m	1456941	0.6 m 1457063
	5 m	1567322	1.5 m 1567270
	10 m	1567335	3 m 1457076
	Variable	1696963	Variable 1697001
M12 female connector, angled 	1.5 m	1456954	0.3 m 1457089
	3 m	1456967	0.6 m 1567225
	5 m	1456970	1.5 m 1567238
	10 m	1456983	3 m 1457092
	Variable	1696989	Variable 1697014
M12 female connector, angled, with 3 LEDs 	1.5 m	1456996	0.3 m 1457102
	3 m	1457005	0.6 m 1567173
	5 m	1567351	1.5 m 1567199
	10 m	1567364	3 m 1457115
	Variable	1696992	Variable 1697027

Information for products with fixed cable length:

Products with fixed cable length are produced with the highly flexible 800 cable type and are available from stock.

Cable description	Cable type	Color coding	Pin assignment
TPE-U highly flexible – gray Robots and drag chains	800	BN WH BK BU	1 2 4 3

Ordering data for products with variable cable:

For a 4.5 m long sensor/actuator cable, TPE-U 800, with a straight 4-pos. M12 connector and free cable end, the ordering data is as follows:

Order No.	Cable type	Length [m]
1696947	800	4.5
Minimum order amount:		Increments:
25 pcs.		0.2 ... 3 m = 0.1 m
		> 3 m = 0.5 m

	Technical data	Technical data
	M12 4-pos.	M12 4-pos., with LED
Rated voltage	250 V AC / 250 V DC	24 V / 24 V DC
Rated current [A]	4	4
Contact material	CuSn	CuSn
Contact surface material	Ni/Au	Ni/Au
Material of grip body	TPU, hardly inflammable, self-extinguishing	TPU, hardly inflammable, self-extinguishing
Material, knurls	Zinc die-cast, nickel-plated	Zinc die-cast, nickel-plated
M12 circular connector in accordance with:	IEC 61076-2-101	IEC 61076-2-101
Degree of protection	IP65 / IP67 / IP68	IP65 / IP67 / IP68
Temperature data		
Male connector/female connector	-25 ... 90 [°C]	-25 ... 90

M8 and M12 SAC cable, 4-pos., shielded, cable type: PUR

Notes:
For information about the cable qualities, see page 318

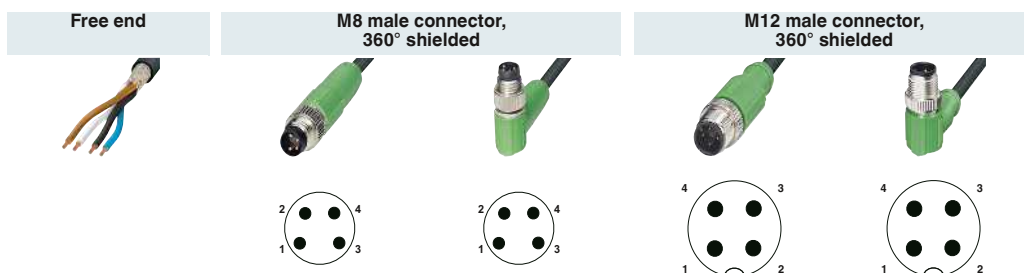

	Ordering data	Ordering data	Ordering data	Ordering data	Ordering data
	Order No.	Order No.	Order No.	Order No.	Order No.
Free end	1.5 m	1.5 m	1.5 m	1.5 m	1.5 m
	3 m	3 m	3 m	3 m	3 m
	5 m	5 m	5 m	5 m	5 m
	10 m	10 m	10 m	10 m	10 m
	Variable	Variable	Variable	Variable	Variable
M8 female connector, straight, 360° shielded	1.5 m	0.3 m			
	3 m	0.6 m			
	5 m	1.5 m			
	10 m	3 m			
	Variable	Variable	Variable		
M8 female connector, angled, 360° shielded	1.5 m				
	3 m				
	5 m				
	10 m				
	Variable	Variable	Variable		
M12 female connector, straight, 360° shielded	1.5 m			0.3 m	
	3 m			0.6 m	
	5 m			1.5 m	
	10 m			3 m	
	Variable			Variable	Variable
M12 female connector, angled, 360° shielded	1.5 m			0.3 m	
	3 m			0.6 m	
	5 m			1.5 m	
	10 m			3 m	
	Variable			Variable	Variable

Information for products with fixed cable length:

Products with fixed cable length are produced with the halogen-free PUR cable type and are available from stock.

Cable description	Cable type	Suitable for:	Color coding	Pin assignment
PUR, halogen-free – black E221474	PUR	M8/M12	BN	1
PVC – black E221474	PVC	M12	WH	2
PVC – gray E221474	500	M12	BK	4
			BU	3

Ordering data for products with variable cable:

For a 4.5 m long shielded sensor/actuator cable, PUR, halogen-free, black, with a straight 4-pos. M12 male and a straight M12 female, the ordering data is as follows:

Order No.	Cable type	Length [m]
1536081	PUR	4.5
Minimum order amount:		
25 pcs.		
Increments:		
0.2 ... 3 m = 0.1 m		
> 3 m = 0.5 m		

With a combination of M12 and M8 connectors, the limiting M8 value applies to the rated voltage.

	Technical data	Technical data
	M8 4-pos., shielded	M12 4-pos., shielded
Rated voltage	48 V AC / 60 V DC	48 V AC / 60 V DC
Rated current	4 [A]	4
Contact material	CuSn	CuSn
Contact surface material	Ni/Au	Ni/Au
Material of grip body	TPU, hardly inflammable, self-extinguishing	TPU, hardly inflammable, self-extinguishing
M8 circular connector in accordance with:	IEC 61076-2-104	-
M12 circular connector in accordance with:	-	-
Degree of protection	IP65 / IP67	IP65 / IP67
Temperature data		
Male connector/female connector	-25 ... 90 [°C]	-25 ... 90

Sensor/actuator cabling

Assembled cables

M8 SAC cable, 5-pos., B-coded, cable type: PUR

Notes:

For information about the cable qualities, see page 318

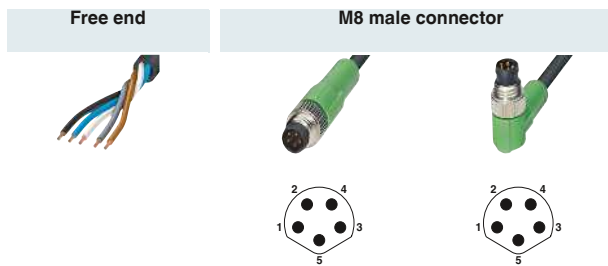

	Ordering data	Ordering data	Ordering data
Free end	Order No.	Order No.	Order No.
	1.5 m	1404461	1.5 m 1404465
	3 m	1404462	3 m 1404466
	5 m	1404463	5 m 1404467
	10 m	1404464	10 m 1404468
M8 female connector, straight 	1.5 m	1404470	0.3 m 1404479
	3 m	1404471	0.6 m 1404480
	5 m	1404473	1.5 m 1404481
	10 m	1404474	3 m 1404482
M8 female connector, angled 	1.5 m	1404475	
	3 m	1404476	
	5 m	1404477	
	10 m	1404478	

Information for products with fixed cable length:

Products with fixed cable length are produced with the halogen-free 115 cable type and are available from stock.

Cable description	Cable type	Color coding	Pin assignment															
PUR, halogen-free – black	115	<table border="1"> <tr><td>BN</td><td></td><td>1</td></tr> <tr><td>WH</td><td></td><td>2</td></tr> <tr><td>BK</td><td></td><td>4</td></tr> <tr><td>BU</td><td></td><td>3</td></tr> <tr><td>GY</td><td></td><td>5</td></tr> </table>	BN		1	WH		2	BK		4	BU		3	GY		5	
BN		1																
WH		2																
BK		4																
BU		3																
GY		5																

Technical data

M8, 5-pos.	
Rated voltage	30 V AC / 30 V DC
Rated current [A]	3
Contact material	CuSn
Contact surface material	Ni/Au
Material of grip body	TPU, hardly inflammable, self-extinguishing
Material, knurls	Zinc die-cast, nickel-plated
M8 circular connector in accordance with:	IEC 61076-2-104
Degree of protection	IP65 / IP67 / IP68
Temperature data	
Male connector/female connector [°C]	-25 ... 90

M12 SAC cable, 5-pos., cable type: PUR

Notes:
For information about the cable qualities, see page 318

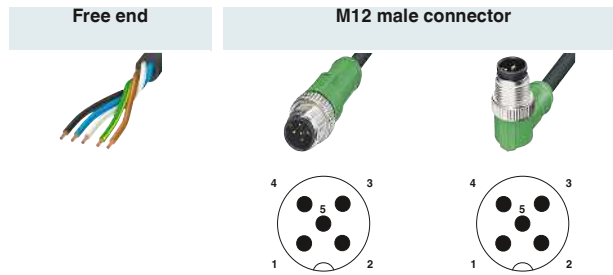

	Ordering data	Ordering data	Ordering data	
Free end	Order No.	Order No.	Order No.	
	1.5 m	1669767	1.5 m 1669796	
	3 m	1669770	3 m 1669806	
	5 m	1669783	5 m 1669819	
	10 m	1683361	10 m 1694460	
	Variable	1697098	Variable 1697108	
M12 female connector, straight 	1.5 m	1669822	0.3 m 1681583	
	3 m	1669835	0.6 m 1681596	
	5 m	1669848	1.5 m 1681606	
	10 m	1683374	3 m 1681619	
	Variable	1697111	Variable 1697140	
M12 female connector, angled 	1.5 m	1669851	0.3 m 1681622	
	3 m	1669864	0.6 m 1681635	
	5 m	1669877	1.5 m 1681648	
	10 m	1694541	3 m 1681651	
	Variable	1697124	Variable 1697153	
M12 female connector, angled, with 3 LEDs 	1.5 m	1669880	0.3 m 1694635	
	3 m	1669893	0.6 m 1694648	
	5 m	1669903	1.5 m 1694651	
	10 m	1694431		
	Variable	1697137	Variable 1697166	
		Variable 1508734	Variable 1529506	Variable 1552159

Information for products with fixed cable length:

Products with fixed cable length are produced with the halogen-free PUR cable type and are available from stock.

Ordering data for products with variable cable:

For a 4.5 m long sensor/actuator cable, PUR, halogen-free, black, with a straight 5-pos. M12 male and a straight M12 female, the ordering data is as follows:

Order No.	Cable type	Length [m]
1697140	PUR	4.5
Minimum order amount:		25 pcs.
Increments:		0.2 ... 3 m = 0.1 m > 3 m = 0.5 m

Cable description	Cable type	Color coding	Pin assignment
PUR, halogen-free – black E221474	PUR	BN	1
PUR, halogen-free – black, 5th wire gray E221474	115	WH	2
TPE-U highly flexible – gray, 5th wire gray E221474	800	BK	4
PUR irradiated – orange E221474	150	BU	3
PVC – black E221474	PVC	GNYE	5
PVC – black, 5th wire gray E221474	515		
PVC – gray E221474	500		
PVC 105° – yellow E221474	540		
PVC 105° – yellow, 5th wire gray E221474	542		

	Technical data	Technical data
	M12 5-pos.	M12 5-pos., with LED
Rated voltage	48 V AC / 60 V DC	24 V / 24 V DC
Rated current	4	4
Contact material	CuSn	CuSn
Contact surface material	Ni/Au	Ni/Au
Material of grip body	TPU, hardly inflammable, self-extinguishing	TPU, hardly inflammable, self-extinguishing
M12 circular connector in accordance with:	IEC 61076-2-101	IEC 61076-2-101
Degree of protection	IP65 / IP67 / IP68	IP65 / IP67 / IP68
Temperature data		
Male connector/female connector	-25 ... 90	-25 ... 90

Sensor/actuator cabling

Assembled cables

M12 SAC cable, 5-pos., cable type: PVC

Notes:

For information about the cable qualities, see page 318

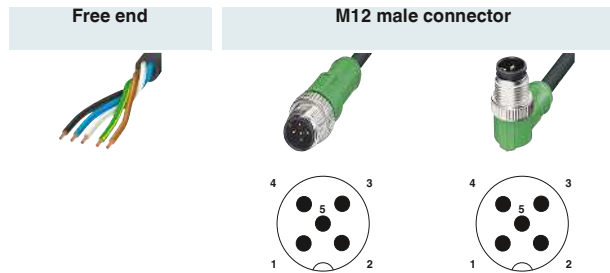

Free end	Ordering data		Ordering data		Ordering data	
	Order No.		Order No.		Order No.	
		1.5 m	1415675	1.5 m	1415679	
		3 m	1415676	3 m	1415680	
		5 m	1415677	5 m	1415681	
		10 m	1415678	10 m	1415682	
		Variable	1697098	Variable	1697108	
M12 female connector, straight 		1.5 m	1415683	0.3 m	1415695	
		3 m	1415684	0.6 m	1415696	
		5 m	1453889	1.5 m	1415697	
		10 m	1415685	3 m	1415698	
		Variable	1697111	Variable	1697140	Variable
M12 female connector, angled 		1.5 m	1415686	0.3 m	1415699	
		3 m	1415687	0.6 m	1415700	
		5 m	1415688	1.5 m	1415701	
		10 m	1415689	3 m	1415702	
		Variable	1697124	Variable	1697153	Variable
M12 female connector, angled, with 3 LEDs 		1.5 m	1415690	0.3 m	1415703	
		3 m	1415691	0.6 m	1415704	
		5 m	1415693	1.5 m	1415705	
		10 m	1415694	3 m	1415706	
		Variable	1697137	Variable	1697166	Variable

Information for products with fixed cable length:

Products with fixed cable length are produced with the PVC cable type and are available from stock.

Ordering data for products with variable cable:

For a 4.5 m long sensor/actuator cable, PVC - black, with a straight 5-pos. M12 male and a straight M12 female, the ordering data is as follows:

Order No.	Cable type	Length [m] 40 m, maximum
1697140	PVC	4.5

Minimum order amount:
25 pcs.

Increments:
0.2 ... 3 m = 0.1 m
> 3 m = 0.5 m

Cable description	Cable type	Color coding	Pin assignment
PVC - black E221474	PVC	BN	1
PVC - black, 5th wire gray E221474	515	WH	2
PVC - gray E221474	500	BK	4
PVC 105° - yellow E221474	540	BU	3
PVC 105° - yellow, 5th wire gray E221474	542	GNYE	5
PUR, halogen-free - black E221474	PUR		
PUR, halogen-free - black, 5th wire gray E221474	115		
PUR irradiated - orange E221474	150		
TPE-U highly flexible - gray, 5th wire gray E221474	800		

	Technical data	Technical data
	M12 5-pos.	M12 5-pos., with LED
Rated voltage	48 V AC / 60 V DC	24 V / 24 V DC
Rated current [A]	4	4
Contact material	CuSn	CuSn
Contact surface material	Ni/Au	Ni/Au
Material of grip body	TPU, hardly inflammable, self-extinguishing	TPU, hardly inflammable, self-extinguishing
M12 circular connector in accordance with:	-	IEC 61076-2-101
Degree of protection	IP65 / IP67 / IP68	IP65 / IP67 / IP68
Temperature data		
Male connector/female connector [°C]	-25 ... 90	-25 ... 90

M12 SAC cable, 5-pos., cable type: 802

Notes:
For information about the cable qualities, see page 324

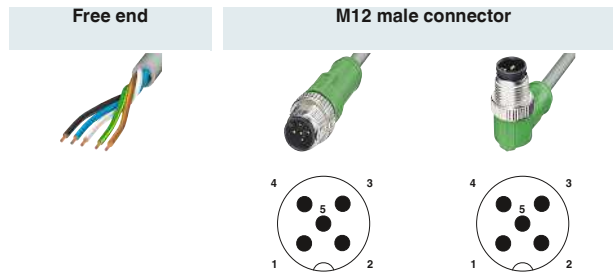

	Ordering data	Ordering data	Ordering data
Free end	Order No.	Order No.	Order No.
	1.5 m	1.5 m	1.5 m
	3 m	3 m	3 m
	5 m	5 m	5 m
	10 m	10 m	10 m
	Variable	Variable	Variable
	1697098	1697108	1697108
M12 female connector, straight	Order No.	Order No.	Order No.
	1.5 m	0.3 m	0.3 m
	3 m	0.6 m	0.6 m
	5 m	1.5 m	1.5 m
	10 m	3 m	3 m
	Variable	Variable	Variable
	1454419	1457267	1457267
	1457160	1454561	1454561
	1454422	1454587	1454587
	1454448	1457270	1457270
	1697111	1697140	1697140
M12 female connector, angled	Order No.	Order No.	Order No.
	1.5 m	0.3 m	0.3 m
	3 m	0.6 m	0.6 m
	5 m	1.5 m	1.5 m
	10 m	3 m	3 m
	Variable	Variable	Variable
	1457173	1457283	1457283
	1457186	1454516	1454516
	1457199	1454532	1454532
	1457209	1457296	1457296
	1697124	1697153	1697153
M12 female connector, angled, with 3 LEDs	Order No.	Order No.	Order No.
	1.5 m	0.3 m	0.3 m
	3 m	0.6 m	0.6 m
	5 m	1.5 m	1.5 m
	10 m	3 m	3 m
	Variable	Variable	Variable
	1454367	1457306	1457306
	1457212	1454464	1454464
	1454370	1454480	1454480
	1454396	1457319	1457319
	1697137	1697166	1697166

Information for products with fixed cable length:

Products with fixed cable length are produced with the 802 cable type and are available from stock.

Cable description	Cable type	Color coding	Pin assignment
TPE-U highly flexible – gray Robots and drag chains	802	BN WH BK BU GNYE	1 2 4 3 5

Ordering data for products with variable cable:

For a 4.5 m long sensor/actuator cable, TPE-U 802, with a straight 5-pos. M12 connector and free cable end, the ordering data is as follows:

Order No.	Cable type	Length [m]
1697098	802	4.5
Minimum order amount: 25 pcs.		
Increments: 0.2 ... 3 m = 0.1 m > 3 m = 0.5 m		

	Technical data	Technical data
	M12 5-pos.	M12 5-pos., with LED
Rated voltage	48 V AC / 60 V DC	24 V / 24 V DC
Rated current	4	4
Contact material	CuSn	CuSn
Contact surface material	Ni/Au	Ni/Au
Material of grip body	TPU, hardly inflammable, self-extinguishing	TPU, hardly inflammable, self-extinguishing
Material, knurls	Zinc die-cast, nickel-plated	Zinc die-cast, nickel-plated
M12 circular connector in accordance with:	IEC 61076-2-101	IEC 61076-2-101
Degree of protection	IP65 / IP67 / IP68	IP65 / IP67 / IP68
Temperature data		
Male connector/female connector	[-25 ... 90	[-25 ... 90

Sensor/actuator cabling

Assembled cables

M12 SAC cable, 5-pos., shielded, cable type: PUR

Notes:

For information about the cable qualities, see page 318

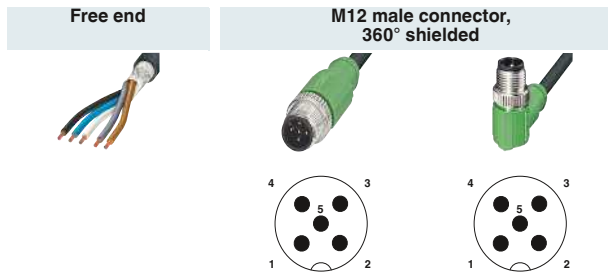

Free end	Ordering data		Ordering data		Ordering data	
	Order No.	Length	Order No.	Length	Order No.	Length
		1.5 m	1682728	1.5 m	1682757	1.5 m
		3 m	1682744	3 m	1682760	3 m
		5 m	1682731	5 m	1682773	5 m
		10 m	1500732	10 m	1500745	10 m
		Variable	1697506	Variable	1697519	Variable
		1.5 m	1682935	0.3 m	1500884	
		3 m	1682948	0.6 m	1500897	
		5 m	1682951	1.5 m	1500907	
		10 m	1500758	3 m	1500910	
		Variable	1697522	Variable	1536120	Variable
		1.5 m	1682964	0.3 m	1501003	
		3 m	1682977	0.6 m	1501029	
		5 m	1682980	1.5 m	1501045	
		10 m	1500761	3 m	1501058	
		Variable	1697535	Variable	1536133	Variable

Information for products with fixed cable length:

Products with fixed cable length are produced with the halogen-free PUR cable type and are available from stock.

Cable description	Cable type	Color coding	Pin assignment
PUR, halogen-free – black E221474	PUR	BN	1
		WH	2
PVC – black E221474	PVC	BK	4
		BU	3
PVC – gray E221474	500	GY	5

Ordering data for products with variable cable:

For a 4.5 m long shielded sensor/actuator cable, PUR, halogen-free, black, with a straight 5-pos. M12 male and a straight M12 female, the ordering data is as follows:

Order No.	Cable type	Length [m]
1536120	PUR	4.5
Minimum order amount:		4.5
25 pcs.		Increments: 0.2 ... 3 m = 0.1 m > 3 m = 0.5 m

Technical data	
M12	
5-pos., shielded	
Rated voltage	48 V AC / 60 V DC
Rated current [A]	4
Contact material	CuSn
Contact surface material	Ni/Au
Material of grip body	TPU, hardly inflammable, self-extinguishing
M12 circular connector in accordance with:	IEC 61076-2-101
Degree of protection	IP65 / IP67
Temperature data	
Male connector/female connector [°C]	-25 ... 90

**M8 SAC cable,
6-pos.,
cable type: PUR**

Notes:
For information about the cable qualities, see page 318

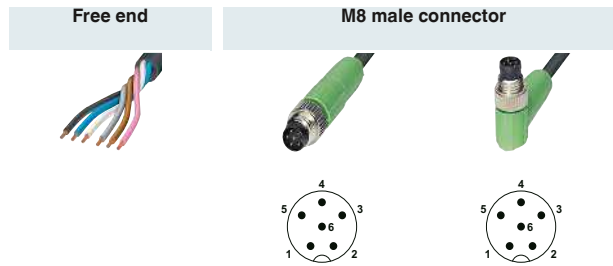

Free end	Ordering data		Ordering data		Ordering data	
	Order No.	Order No.	Order No.	Order No.	Order No.	Order No.
		1.5 m	1522095	1.5 m	1522147	
		3 m	1522105	3 m	1522150	
		5 m	1522118	5 m	1522163	
		10 m	1522121	10 m	1522176	
		Variable	1522134	Variable	1522189	
M8 female connector, straight 		1.5 m	1522192			
		3 m	1522202			
		5 m	1522215			
		10 m	1522228			
		Variable	1522231	Variable	1551927	Variable
M8 female connector, angled 		1.5 m	1522244			
		3 m	1522257			
		5 m	1522260			
		10 m	1522273			
		Variable	1522286	Variable	1551930	Variable

Information for products with fixed cable length:

Products with fixed cable length are produced with the halogen-free **PUR** cable type and are available from stock.

Cable description	Cable type	Color coding	Pin assignment
PUR, halogen-free – black E221474	PUR	BN WH BU BK GY PK	1 2 3 4 5 6

Ordering data for products with variable cable:

For a 4.5 m long shielded sensor/actuator cable, PUR, halogen-free, black, with a straight 6-pos. M8 connector and open cable end, the ordering data is as follows:

Order No.	Cable type	Length [m]
1522134	PUR	4.5
Minimum order amount: 25 pcs.		
Increments: 0.2 ... 3 m = 0.1 m > 3 m = 0.5 m		

Technical data	
M8 6-pos.	
Rated voltage	30 V AC / 30 V DC
Rated current [A]	1.5
Contact material	CuZn
Contact surface material	Ni/Au
Material of grip body	TPU, hardly inflammable, self-extinguishing
M8 circular connector in accordance with:	IEC 61076-2-104
Degree of protection	IP65 / IP67 / IP68
Temperature data	
Male connector/female connector [°C]	-25 ... 90

Sensor/actuator cabling

Assembled cables

M8 SAC cable, 6-pos., shielded, cable type: PUR

Notes:

For information about the cable qualities, see page 318

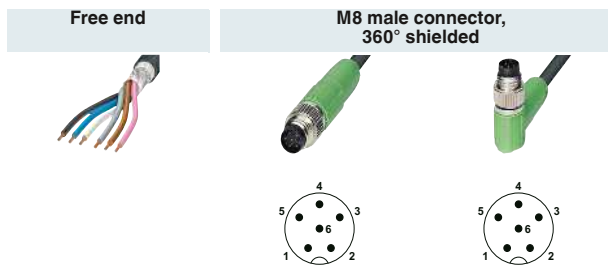

	Ordering data	Ordering data	Ordering data
Free end	Order No.	Order No.	Order No.
	1.5 m	1522299	1.5 m 1522341
	3 m	1522309	3 m 1522354
	5 m	1522312	5 m 1522367
	10 m	1522325	10 m 1522370
	Variable	1522338	Variable 1522383
M8 female connector, straight, 360° shielded	Order No.	Order No.	Order No.
	1.5 m	1522396	
	3 m	1522406	
	5 m	1522419	
	10 m	1522422	
	Variable	1522435	Variable 1552010
			Variable 1552036
M8 female connector, angled, 360° shielded	Order No.	Order No.	Order No.
	1.5 m	1522448	
	3 m	1522451	
	5 m	1522464	
	10 m	1522477	
	Variable	1522480	Variable 1552023
			Variable 1552049

Information for products with fixed cable length:

Products with fixed cable length are produced with the halogen-free PUR cable type and are available from stock.

Cable description	Cable type	Color coding	Pin assignment																		
PUR, halogen-free – black E221474	PUR	<table border="1"> <tr><td>BN</td><td></td><td>1</td></tr> <tr><td>WH</td><td></td><td>2</td></tr> <tr><td>BU</td><td></td><td>3</td></tr> <tr><td>BK</td><td></td><td>4</td></tr> <tr><td>GY</td><td></td><td>5</td></tr> <tr><td>PK</td><td></td><td>6</td></tr> </table>	BN		1	WH		2	BU		3	BK		4	GY		5	PK		6	
BN		1																			
WH		2																			
BU		3																			
BK		4																			
GY		5																			
PK		6																			

Ordering data for products with variable cable:

For a 4.5 m long shielded sensor/actuator cable, PUR, halogen-free, black, with a straight 6-pos. M8 male and a straight M8 female, the ordering data is as follows:

Order No.	Cable type	Length [m]
1552010	PUR	4.5
Minimum order amount:		Increments:
25 pcs.		0.2 ... 3 m = 0.1 m
		> 3 m = 0.5 m

Technical data	
M8	
6-pos., shielded	
30 V AC / 30 V DC	
Rated voltage	
Rated current [A]	1.5
Contact material	CuZn
Contact surface material	Ni/Au
Material of grip body	TPU, hardly inflammable, self-extinguishing
M8 circular connector in accordance with:	IEC 61076-2-104
Degree of protection	IP65 / IP67
Temperature data	
Male connector/female connector [°C]	-25 ... 90

**M8 SAC cable,
8-pos.,
cable type: PUR**

Notes:
For information about the cable qualities, see page 318

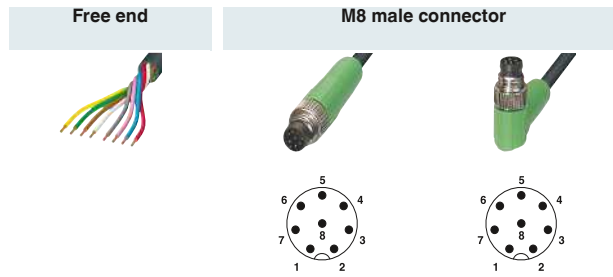

Free end	Ordering data		Ordering data		Ordering data	
	Order No.	Order No.	Order No.	Order No.	Order No.	Order No.
		1.5 m	1404178	1.5 m	1404182	
		3 m	1404180	3 m	1404186	
		5 m	1404181	5 m	1404185	
		10 m	1404179	10 m	1404183	
M8 female connector, straight 	1.5 m	1404187	0.3 m	1404196		
	3 m	1404188	0.6 m	1404198		
	5 m	1404189	1.5 m	1404199		
	10 m	1404190	3 m	1404200		
M8 female connector, angled 	1.5 m	1404191	0.3 m	1404201		
	3 m	1404192	0.6 m	1404202		
	5 m	1404193	1.5 m	1404203		
	10 m	1404194	3 m	1404204		

Information for products with fixed cable length:

Products with fixed cable length are produced with the halogen-free **PUR** cable type and are available from stock.

Cable description	Cable type	Color coding	Pin assignment
PUR, halogen-free – black	PUR	WH BN GN YE GY PK BU RD	1 2 3 4 5 6 7 8

Technical data

M8 8-pos.	
Rated voltage	30 V AC / 30 V DC
Rated current [A]	1.5
Contact material	CuSn
Contact surface material	Ni/Au
Material of grip body	TPU, hardly inflammable, self-extinguishing
Material, knurls	Zinc die-cast, nickel-plated
M8 circular connector in accordance with:	IEC 61076-2-104
Degree of protection	IP65 / IP67 / IP68
Temperature data	
Male connector/female connector [°C]	-25 ... 85

Sensor/actuator cabling

Assembled cables

M12 SAC cable, 8-pos., cable type: PUR

Notes:

For information about the cable qualities, see page 318

Free end



M12 male connector

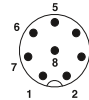
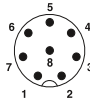

Ordering data

Ordering data

Ordering data

Free end	Order No.	Order No.	Order No.
	1.5 m	1522493	1.5 m 1522545
	3 m	1522503	3 m 1522558
	5 m	1522516	5 m 1522561
	10 m	1522529	10 m 1522574
	Variable	1522532	Variable 1522587
M12 female connector, straight 	1.5 m	1522590	0.3 m 1522671
	3 m	1522600	0.6 m 1522684
	5 m	1520369	1.5 m 1522697
	10 m	1520372	3 m 1522707
	Variable	1522613	Variable 1522710
M12 female connector, angled 	1.5 m	1522626	0.3 m 1522723
	3 m	1522639	0.6 m 1522736
	5 m	1522642	1.5 m 1522749
	10 m	1522655	3 m 1522752
	Variable	1522668	Variable 1522765

Information for products with fixed cable length:

Products with fixed cable length are produced with the halogen-free PUR cable type and are available from stock.

Ordering data for products with variable cable:

For a 4.5 m long sensor/actuator cable, PUR, halogen-free, black, with a straight 8-pos. M12 male and a straight M12 female, the ordering data is as follows:

Cable description	Cable type	Color coding	Pin assignment
PUR, halogen-free – black E221474	PUR	WH	1
TPE-U highly flexible – gray E221474	800	BN	2
PVC – black E221474	PVC	GN	3
PVC – gray E221474	500	YE	4
		GY	5
		PK	6
		BU	7
		RD	8

Order No.	Cable type	Length [m]
1522710	PUR	4.5
Minimum order amount:		Increments:
25 pcs.		0.2 ... 3 m = 0.1 m
		> 3 m = 0.5 m

Technical data

M12 8-pos.	
Rated voltage	30 V AC / 30 V DC
Rated current [A]	2
Contact material	CuZn
Contact surface material	Ni/Au
Material of grip body	TPU, hardly inflammable, self-extinguishing
M12 circular connector in accordance with:	IEC 61076-2-101
Degree of protection	IP65 / IP67 / IP68
Temperature data	
Male connector/female connector [°C]	-25 ... 90

**M12 SAC cable,
8-pos.,
cable type: PVC**

Notes:
For information about the cable qualities, see page 318

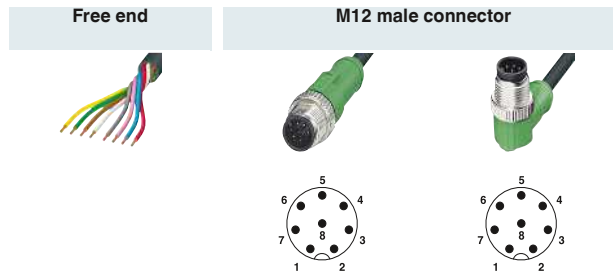

Free end	Ordering data		Ordering data		Ordering data	
	Order No.	Order No.	Order No.	Order No.	Order No.	Order No.
	1.5 m	1415716	1.5 m	1415720		
	3 m	1415717	3 m	1415721		
	5 m	1415718	5 m	1415722		
	10 m	1415719	10 m	1415723		
	Variable	1522532	Variable	1522587		
M12 female connector, straight 	1.5 m	1415724	0.3 m	1415737		
	3 m	1415725	0.6 m	1415738		
	5 m	1415726	1.5 m	1415739		
	10 m	1415727	3 m	1415740		
	Variable	1522613	Variable	1522710	Variable	1551969
M12 female connector, angled 	1.5 m	1415732	0.3 m	1415745		
	3 m	1415734	0.6 m	1415746		
	5 m	1415735	1.5 m	1415747		
	10 m	1415736	3 m	1415748		
	Variable	1522668	Variable	1522765	Variable	1551972

Information for products with fixed cable length:

Products with fixed cable length are produced with the PVC cable type and are available from stock.

Ordering data for products with variable cable:

For a 4.5 m long sensor/actuator cable, PVC - black, with a straight 8-pos. M12 male and a straight M12 female, the ordering data is as follows:

Order No.	Cable type	Length [m]
1522710	PVC	4.5
Minimum order amount:		
25 pcs.		
Increments:		
0.2 ... 3 m = 0.1 m		
> 3 m = 0.5 m		

Cable description	Cable type	Color coding	Pin assignment
PVC – black E221474	PVC	WH	1
		BN	2
PVC – gray E221474	500	GN	3
		YE	4
PUR, halogen-free – black E221474	PUR	GY	5
		PK	6
TPE-U highly flexible – gray E221474	800	BU	7
		RD	8

Technical data

M12 8-pos.	
Rated voltage	30 V AC / 30 V DC
Rated current	2 [A]
Contact material	CuZn
Contact surface material	Ni/Au
Material of grip body	TPU, hardly inflammable, self-extinguishing
M12 circular connector in accordance with:	IEC 61076-2-101
Degree of protection	IP65 / IP67 / IP68
Temperature data	
Male connector/female connector	-25 ... 90 [°C]

Sensor/actuator cabling

Assembled cables

M8 SAC cable, 8-pos., shielded, cable type: PUR

Notes:

For information about the cable qualities, see page 318

Free end



M8 male connector, 360° shielded

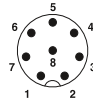

	Ordering data		Ordering data		Ordering data	
Free end	Order No.		Order No.		Order No.	
		1.5 m	1404137			
		3 m	1404140			
		5 m	1404141			
		10 m	1404138			
M8 female connector, straight, 360° shielded 		1.5 m	1404147	0.3 m	1404133	
		3 m	1404148	0.6 m	1404134	
		5 m	1404149	1.5 m	1404135	
		10 m	1404150	3 m	1404136	

Information for products with fixed cable length:

Products with fixed cable length are produced with the halogen-free PUR cable type and are available from stock.

Cable description	Cable type	Color coding	Pin assignment																								
PUR, halogen-free – black	PUR	<table border="1"> <tr><td>WH</td><td></td><td>1</td></tr> <tr><td>BN</td><td></td><td>2</td></tr> <tr><td>GN</td><td></td><td>3</td></tr> <tr><td>YE</td><td></td><td>4</td></tr> <tr><td>GY</td><td></td><td>5</td></tr> <tr><td>PK</td><td></td><td>6</td></tr> <tr><td>BU</td><td></td><td>7</td></tr> <tr><td>RD</td><td></td><td>8</td></tr> </table>	WH		1	BN		2	GN		3	YE		4	GY		5	PK		6	BU		7	RD		8	
WH		1																									
BN		2																									
GN		3																									
YE		4																									
GY		5																									
PK		6																									
BU		7																									
RD		8																									

Technical data

		M8 8-pos.
Rated voltage		30 V AC / 30 V DC
Rated current	[A]	1.5
Contact material		CuSn
Contact surface material		Ni/Au
Material of grip body		TPU, hardly inflammable, self-extinguishing
Material, knurls		Zinc die-cast, nickel-plated
M8 circular connector in accordance with:		IEC 61076-2-104
Degree of protection		IP65 / IP67
Temperature data		
Male connector/female connector	[°C]	-25 ... 85

M12 SAC cable, 8-pos., shielded, cable type: PUR

Notes:

For information about the cable qualities, see page 318

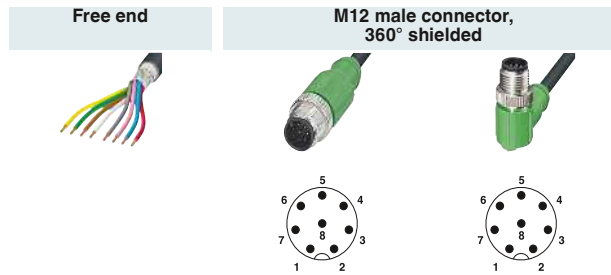

	Ordering data	Ordering data	Ordering data
Free end	Order No.	Order No.	Order No.
	1.5 m	1.5 m 1522778	1.5 m 1522817
	3 m	3 m 1522781	3 m 1522820
	5 m	5 m 1526981	5 m 1522833
	10 m	10 m 1522794	10 m 1522846
	Variable	Variable 1522804	Variable 1522859
M12 female connector, straight, 360° shielded 	1.5 m	0.3 m 1522969	
	3 m	0.6 m 1522972	
	5 m	1.5 m 1522985	
	10 m	3 m 1522998	
	Variable	Variable 1523007	Variable 1551998
M12 female connector, angled, 360° shielded 	1.5 m	0.3 m 1523010	
	3 m	0.6 m 1523023	
	5 m	1.5 m 1523036	
	10 m	3 m 1523049	
	Variable	Variable 1523052	Variable 1552007

Information for products with fixed cable length:

Products with fixed cable length are produced with the halogen-free PUR cable type and are available from stock.

Ordering data for products with variable cable:

For a 4.5 m long shielded sensor/actuator cable, PUR, halogen-free, black, with a straight 8-pos. M12 male and a straight M12 female, the ordering data is as follows:

Order No.	Cable type	Length [m]
1523007	PUR	4.5
Minimum order amount:		25 pcs.
Increments:		0.2 ... 3 m = 0.1 m > 3 m = 0.5 m

Cable description	Cable type	Color coding	Pin assignment
PUR, halogen-free – black E221474	PUR	WH	1
PUR, halogen-free – gray E221474	280	BN	2
PVC – black E221474	PVC	GN	3
		YE	4
		GY	5
		PK	6
		BU	7
		RD	8

Technical data
M12
8-pos., shielded
30 V AC / 30 V DC
2
CuZn
Ni/Au
TPU, hardly inflammable, self-extinguishing
IEC 61076-2-101
IP65 / IP67
Male connector/female connector
-25 ... 90

Sensor/actuator cabling

Assembled cables

M12 SAC cable, 12 and 17-pos., cable type: PUR

Notes:

For information about the cable qualities, see page 318

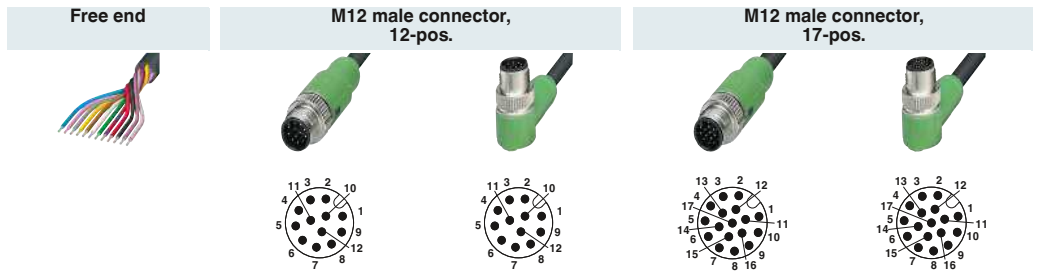

Free end	Ordering data	Ordering data	Ordering data	Ordering data	Ordering data	
	Order No.	Order No.	Order No.	Order No.	Order No.	
	1.5 m	1430530	1.5 m	1430572	1.5 m	1430695
	3 m	1430543	3 m	1430585	3 m	1430705
	5 m	1430556	5 m	1430598	5 m	1430718
	10 m	1430569	10 m	1430608	10 m	1430721
M12 female, 12-pos., straight 	1.5 m	1430611				
	3 m	1430624				
	5 m	1430637				
	10 m	1430640				
M12 female, 12-pos., angled 	1.5 m	1430653				
	3 m	1430666				
	5 m	1430679				
	10 m	1430682				
M12 female, 17-pos., straight 	1.5 m	1430776				
	3 m	1430789				
	5 m	1430792				
	10 m	1430802				
M12 female, 17-pos., angled 	1.5 m	1430815				
	3 m	1430828				
	5 m	1430831				
	10 m	1430844				

Information for products with fixed cable length:

Products with fixed cable length are produced with the halogen-free PUR cable type and are available from stock.

Cable description	Cable type	Color coding	Pin assignment, 17-pos.
PUR, halogen-free – black	PUR	BN	1
		BU	2
		WH	3
		GN	4
		PK	5
		YE	6
		BK	7
		GY	8
		RD	9
		VT	10
		GYPK	11
		RDBU	12
		WHGN	13
		BNGN	14
		WHYE	15
		YEEN	16
		WHGY	17

	Technical data	Technical data
	M12 12-pos.	M12 17-pos.
Rated voltage	30 V AC / 30 V DC	30 V AC / 30 V DC
Rated current [A]	1.5	1.5
Contact material	CuZn	CuZn
Contact surface material	Ni/Au	Ni/Au
Material of grip body	TPU, hardly inflammable, self-extinguishing	TPU, hardly inflammable, self-extinguishing
M12 circular connector in accordance with:	IEC 61076-2-101	IEC 61076-2-101
Degree of protection	IP65 / IP67 / IP68	IP65 / IP67 / IP68
Temperature data		
Male connector/female connector [°C]	-25 ... 85	-25 ... 90

M12 SAC cable, 12 and 17-pos., cable type: PVC

Notes:

For information about the cable qualities, see page 318

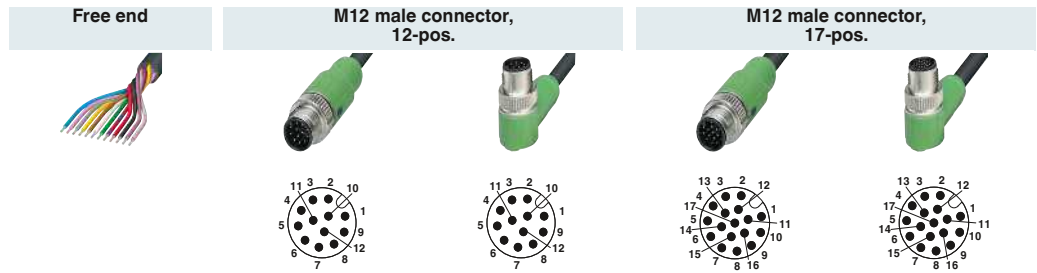

	Ordering data	Ordering data	Ordering data	Ordering data	Ordering data
Free end	Order No.	Order No.	Order No.	Order No.	Order No.
	1.5 m	1.5 m	1.5 m	1.5 m	1.5 m
	3 m	3 m	3 m	3 m	3 m
	5 m	5 m	5 m	5 m	5 m
	10 m	10 m	10 m	10 m	10 m
M12 female, 12-pos., straight 	1.5 m	1.5 m	1.5 m	1.5 m	1.5 m
	3 m	3 m	3 m	3 m	3 m
	5 m	5 m	5 m	5 m	5 m
	10 m	10 m	10 m	10 m	10 m
M12 female, 12-pos., angled 	1.5 m	1.5 m	1.5 m	1.5 m	1.5 m
	3 m	3 m	3 m	3 m	3 m
	5 m	5 m	5 m	5 m	5 m
	10 m	10 m	10 m	10 m	10 m
M12 female, 17-pos., straight 	1.5 m	1.5 m	1.5 m	1.5 m	1.5 m
	3 m	3 m	3 m	3 m	3 m
	5 m	5 m	5 m	5 m	5 m
	10 m	10 m	10 m	10 m	10 m
M12 female, 17-pos., angled 	1.5 m	1.5 m	1.5 m	1.5 m	1.5 m
	3 m	3 m	3 m	3 m	3 m
	5 m	5 m	5 m	5 m	5 m
	10 m	10 m	10 m	10 m	10 m

Information for products with fixed cable length:

Products with fixed cable length are produced with the PVC cable type and are available from stock.

Cable description	Cable type	Color coding	Pin assignment, 17-pos.
PVC – black	PVC	BN	1
		BU	2
		WH	3
		GN	4
		PK	5
		YE	6
		BK	7
		GY	8
		RD	9
		VT	10
		GYPK	11
		RDBU	12
		WHGN	13
		BNGN	14
		WHYE	15
		YEBN	16
		WHGY	17

Color coding	Pin assignment, 12-pos.
BN	1
BU	2
WH	3
GN	4
PK	5
YE	6
BK	7
GY	8
RD	9
VT	10
GYPK	11
RDBU	12

	Technical data	Technical data
	M12 12-pos.	M12 17-pos.
Rated voltage	30 V AC / 30 V DC	30 V AC / 30 V DC
Rated current	[A] 1.5	1.5
Contact material	CuZn	CuZn
Contact surface material	Ni/Au	Ni/Au
Material of grip body	TPU, hardly inflammable, self-extinguishing	TPU, hardly inflammable, self-extinguishing
M12 circular connector in accordance with:	IEC 61076-2-101	IEC 61076-2-101
Degree of protection	IP65 / IP67 / IP68	IP65 / IP67 / IP68
Temperature data		
Male connector/female connector	[°C] -25 ... 90	-25 ... 90

Sensor/actuator cabling

Assembled cables

M12 SAC cable, 12-pos., shielded

Notes:
For information about the cable qualities, see page 318

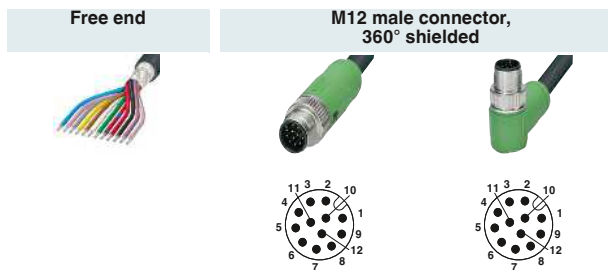

Free end	Ordering data	Ordering data	Ordering data
	Order No.	Order No.	Order No.
		1.5 m	1430048
		3 m	1430051
		5 m	1430064
		10 m	1430077
		1.5 m	1430080
		3 m	1430093
		5 m	1430103
		10 m	1430116

M12 female, straight, 360° shielded

	0.5 m	1437083	3 m	1402551
	1 m	1434730		
	1.5 m	1430129		
	3 m	1430132		
	5 m	1430145		
	10 m	1430158		

M12 female, angled, 360° shielded

	1.5 m	1430161
	3 m	1430174
	5 m	1430187
	10 m	1430190

Information for products with fixed cable length:

Products with fixed cable length are produced with the 35T cable type and are available from stock.

Cable description	Cable type	Color coding	Pin assignment M12																																				
PUR/PVC – black, twisted pair	35T	<table border="1"> <tr><td>BN</td><td></td><td>1</td></tr> <tr><td>BU</td><td></td><td>2</td></tr> <tr><td>WH</td><td></td><td>3</td></tr> <tr><td>GN</td><td></td><td>4</td></tr> <tr><td>PK</td><td></td><td>5</td></tr> <tr><td>YE</td><td></td><td>6</td></tr> <tr><td>BK</td><td></td><td>7</td></tr> <tr><td>GY</td><td></td><td>8</td></tr> <tr><td>RD</td><td></td><td>9</td></tr> <tr><td>VT</td><td></td><td>10</td></tr> <tr><td>GYPK</td><td></td><td>11</td></tr> <tr><td>RDBU</td><td></td><td>12</td></tr> </table>	BN		1	BU		2	WH		3	GN		4	PK		5	YE		6	BK		7	GY		8	RD		9	VT		10	GYPK		11	RDBU		12	
BN		1																																					
BU		2																																					
WH		3																																					
GN		4																																					
PK		5																																					
YE		6																																					
BK		7																																					
GY		8																																					
RD		9																																					
VT		10																																					
GYPK		11																																					
RDBU		12																																					

Technical data

M12 12-pos.	
Rated voltage	30 V AC / 30 V DC
Rated current [A]	1.5
Contact material	CuZn
Contact surface material	Ni/Au
Material of grip body	TPU, hardly inflammable, self-extinguishing
M12 circular connector in accordance with:	IEC 61076-2-101
Degree of protection	IP65 / IP67
Temperature data	
Male connector/female connector [°C]	-25 ... 85

**M12 SAC cable,
17-pos., shielded**

Notes:
For information about the cable qualities, see page 318

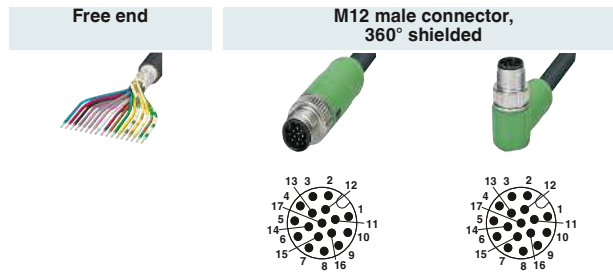

Free end	Ordering data		Ordering data		Ordering data	
	Order No.	Order No.	Order No.	Order No.	Order No.	Order No.
		1.5 m	1430200	1.5 m	1430242	
		3 m	1430213	3 m	1430255	
		5 m	1430226	5 m	1430268	
		10 m	1430239	10 m	1430271	
M12 female, straight, 360° shielded 	1.5 m	1430284				
	3 m	1430297				
	5 m	1430307	5 m	1402421		
	10 m	1430310	10 m	1402422		
M12 female, angled, 360° shielded 	1.5 m	1430323				
	3 m	1430336				
	5 m	1430349				
	10 m	1430352				

Information for products with fixed cable length:

Products with fixed cable length are produced with the 35T cable type and are available from stock.

Cable description	Cable type	Color coding	Pin assignment M12
PUR/PVC – black, twisted pair	35T	BN	1
		BU	2
		WH	3
		GN	4
		PK	5
		YE	6
		BK	7
		GY	8
		RD	9
		VT	10
		GYPK	11
		RDBU	12
		WHGN	13
		BNGN	14
		WHYE	15
		YEBN	16
		WHGY	17

Technical data	
	M12 17-pos.
Rated voltage	30 V AC / 30 V DC
Rated current [A]	1.5
Contact material	CuZn
Contact surface material	Ni/Au
Material of grip body	TPU, hardly inflammable, self-extinguishing
M12 circular connector in accordance with:	IEC 61076-2-101
Degree of protection	IP65 / IP67
Temperature data	
Male connector/female connector [°C]	-25 ... 90

Sensor/actuator cabling

Assembled cables

Plastic-molded M17 and M23 signal connectors

- Feedback connectors
- Contact material gold-plated CuZn
- Flame-retardant TPU handle material
- CuZn or Gd-Zn knurl, nickel-plated
- IP67 degree of protection
- Connector head temperature range -40°C to +105°C
- Standard and counter direction contact numbering
- M17 and M23 standard thread, SPEEDCON fast locking system on request
- Angled versions rotatable

M17, 17-position, female, standard, 60 V, 3.6 A

M23, 12-position, female, counter direction, 150 V, 9 A

M23, 12-position, female, counter direction, 150 V, 9 A



E01

E00

E00

Ordering data

Ordering data

Ordering data

Order No.

Order No.

Order No.

Free end



2 m [1624780](#)
5 m [1624781](#)
10 m [1624782](#)

2 m [1619247](#)
5 m [1619248](#)
10 m [1619249](#)

2 m [1619280](#)
5 m [1619281](#)
10 m [1619282](#)

M17, 17-pos., male



2 m [1624778](#)
5 m [1624783](#)
10 m [1624784](#)

M23, 12-pos., male



2 m [1619289](#)
5 m [1619290](#)
10 m [1619291](#)

M23, 12-pos., male







M23, 17-pos., male



Cable information:

Type/application	Color	Structure	Sheath/core material	Assignment	Temperature range
E00 Feedback	Orange	Shielded, 4 x 2x 0.25 + 2x 0.5	TPU/PP	1 - Pink 2 - Red 3 - Black 4 - Blue 5 - Brown 6 - Green 7 - Violet 8 - Gray 9 - Outer shield 10 - White 11 - n.c. 12 - Brown	Mobile: -20°C ... 60°C Fixed: -40°C ... 80°C
E01 Feedback	Green	Shielded, 3x 2x 0.14 + 2x 0.5 + 4x 0.14 + 4x 0.22	TPU/TPM	1 - Yellow 2 - Green 3 - Red 4 - n.c. 5 - Blue 6 - n.c. 7 - Brown-blue (encoder) 8 - Green-black (+temp.) 9 - Green-red (-temp.) 10 - Brown-red (P encoder) 11 - Black 12 - Brown 13 - Orange 14 - White-black 15 - Brown-gray (OV sense) 16 - Brown-yellow (sense) 17 - n.c. Inner shield on housing	Mobile: -30°C ... 60°C Fixed: -30°C ... 80°C

M23, 12-position, female, standard, 150 V, 9 A		M23, 12-position, female, standard, 150 V, 9 A		M23, 17-position, female, standard, 100 V, 9 A		M23, 17-position, female, standard, 100 V, 9 A	
							
E00		E00		E01		E01	
Ordering data		Ordering data		Ordering data		Ordering data	
Order No.		Order No.		Order No.		Order No.	
2 m	1619250	2 m	1619285	2 m	1619277	2 m	1619286
5 m	1619273	5 m	1619283	5 m	1619278	5 m	1619287
10 m	1619274	10 m	1619284	10 m	1619279	10 m	1619288



2 m	1619292						
5 m	1619293						
10 m	1619294						

2 m [1619295](#)
 5 m [1619296](#)
 10 m [1619297](#)

Sensor/actuator cabling

Assembled cables

Plastic-molded M17 power connectors

- Contact material gold-plated CuZn
- Flame-retardant TPU handle material
- CuZn or Gd-Zn knurl, nickel-plated
- IP67 degree of protection
- Connector head temperature range -40°C to +105°C
- Standard contact numbering
- M17 standard thread, SPEEDCON fast locking system on request

M17, 3+PE-position, female, standard, 630 V, 18 A

M17, 3+PE-position, female, standard, 630 V, 26 A

M17, 5+PE-position, female, standard, 630 V, 12 A



	B00		B01		C00	
	Ordering data		Ordering data		Ordering data	
	Order No.		Order No.		Order No.	
Free end 	2 m	1619298	2 m	1619301	2 m	1619307
	5 m	1619299	5 m	1619302	5 m	1619308
	10 m	1619300	10 m	1619303	10 m	1619309
M17, 3+PE-pos., male 	2 m	1619304	2 m	1619326		
	5 m	1619305	5 m	1619327		
	10 m	1619306	10 m	1619328		
M17, 5+PE-pos., male 					2 m	1619316
					5 m	1619317
					10 m	1619318
M17, 7+PE-pos., male 						

Cable information:

Type	Color	Structure	Sheath/core material	Assignment	Temperature range	
B00 Servo	Orange	Shielded, 4 x 1.50	PUR/TPM	1 - Black U 2 - Black V 3 - Black W	Mobile: -20°C ... 60°C Fixed: -40°C ... 80°C	
B01 Servo	Orange	Shielded, 4 x 2.50	TPU/TPM	PE - Green-yellow	Mobile: -20°C ... 70°C Fixed: -50°C ... 80°C	
C00 Servo	Orange	Shielded, 4 x 0.75 + 2 x 0.5	PUR/TPM	1 - Black U 6 - Black V 7 - Black W PE - Green-yellow	3 - Black, 5 (brake) 4 - Black, 6 (brake)	Mobile: -30°C ... 70°C Fixed: -40°C ... 80°C
C01 Servo	Orange	Shielded, 4G1 + 2 x 0.5	PUR/TPE	1 - Black U 6 - Black V 7 - Black W PE - Green-yellow	3 - Black (brake) 4 - White (brake)	Mobile: -5°C ... 70°C Fixed: -30°C ... 70°C
D00 Servo	Orange	Shielded, 4 x 0.75 + 2 x 2 x 0.34	PUR/TPM	1 - Black U 2 - Black V 3 - Black W	4 - Black 5 (brake) 5 - Black 6 (brake) 6 - Black 7 (temp. +)	Mobile: -30°C ... 90°C Fixed: -40°C ... 90°C
D01 Servo	Orange	Shielded, 4 x 1.0 + 2 x 2 x 0.75	PUR/TPM	PE - Green-yellow	7 - Black 8 (temp. -)	Mobile: -40°C ... 60°C Fixed: -40°C ... 80°C

M17, 5+PE-position,
female, standard,
630 V, 15 A



M17, 7+PE-position,
female, standard,
630 V, 12 A



M17, 7+PE-position,
female, standard,
630 V, 15 A



D00

D01

Ordering data		Ordering data		Ordering data	
Order No.		Order No.		Order No.	
2 m	1619310	2 m	1624785	2 m	1619313
5 m	1619311	5 m	1624786	5 m	1619314
10 m	1619312	10 m	1624792	10 m	1619315

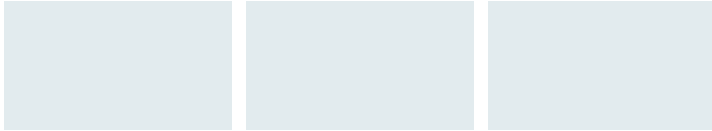

2 m [1619319](#)
5 m [1619321](#)
10 m [1619322](#)

	2 m 1624787	2 m 1619323
	5 m 1624788	5 m 1619324
	10 m 1624789	10 m 1619325

Sensor/actuator cabling

Assembled cables

Plastic-molded M23 power connectors

- Contact material gold-plated CuZn
- Flame-retardant TPU handle material
- CuZn or Gd-Zn knurl, nickel-plated
- IP67 degree of protection
- Connector head temperature range -40°C to +105°C
- Standard contact numbering
- M23 standard thread, SPEEDCON fast locking system on request
- Angled version rotatable (only with reinforced device connector [1620619](#))

	M23, 3+PE-position, female, standard, 630 V, 34 A	M23, 4+PE-position, female, standard, 630 V, 34 A	M23, 5+PE-position, female, standard, 630 V, 18 A
			
	A00	A01	C02
	Ordering data	Ordering data	Ordering data
	Order No.	Order No.	Order No.
Free end 	2 m 1624771 5 m 1619622 10 m 1624772	2 m 1625776 5 m 1625777 10 m 1625775	2 m 1618957 5 m 1618958 10 m 1618959
M23, 3+PE-pos., male 	2 m 1624773 5 m 1619606 10 m 1624774		
M23, 4+PE-pos., male 		2 m 1625779 5 m 1625781 10 m 1625780	
M23, 5+PE-pos., male 			2 m 1618964 5 m 1618965 10 m 1618966

Cable information:

Type	Color	Structure	Sheath/core material	Assignment	Temperature range	
A00 Energy	Gray	Shielded, 4x 4.0	PVC/PVC	1 - n.c. 2 - Black 3 PE - Green-yellow	4 - Black 1 5 - Black 2 6 - n.c.	Fixed: -40°C ... 90°C
A01 Energy	Gray	5x 4.0	PVC/PVC	1 - Black 4 2 - Black 3 PE - Green-yellow	4 - Black 1 5 - Black 2 6 - n.c.	Fixed: -40°C ... 90°C
C02 Servo	Orange	Shielded, 4x 1.50 + 2x 1.5	PUR/TPM	1 - Black U 2 - Black V 6 - Black W PE - Green-yellow	4 - Black, (BR1 brake) 5 - White, (BR2 brake)	Mobile: -20°C ... 60°C Fixed: -40°C ... 80°C
C03 Servo	Orange	Shielded, 4x 2.50 + 2x 1.5	TPU/TPM			Mobile: -20°C ... 70°C Fixed: -50°C ... 80°C

M23, 5+PE-position,
female, standard,
630 V, 18 A

M23, 5+PE-position,
female, standard,
630 V, 26 A

M23, 5+PE-position,
female, standard,
630 V, 26 A



C02

C03

C03

Ordering data

Ordering data

Ordering data

Order No.

Order No.

Order No.

2 m [1620415](#)
5 m [1620416](#)
10 m [1620417](#)

2 m [1620396](#)
5 m [1620397](#)
10 m [1620398](#)

2 m [1620418](#)
5 m [1620419](#)
10 m [1620420](#)

2 m [1620406](#)
5 m [1620407](#)
10 m [1620408](#)

Sensor/actuator cabling

Assembled cables

Plastic-molded M23 power connectors

- Contact material gold-plated CuZn
- Flame-retardant TPU handle material
- CuZn or Gd-Zn knurl, nickel-plated
- IP67 degree of protection
- Connector head temperature range -40°C to +105°C
- Standard contact numbering
- M23 standard thread, SPEEDCON fast locking system on request
- Angled version rotatable (only with reinforced device connector 1620620)

	M23, 4+3+PE-position, female, standard, 250 V/630 V, 18 A	M23, 4+3+PE-position, female, standard, 250 V/630 V, 18 A	M23, 4+3+PE-position, female, standard, 250 V/630 V, 26 A
			
	D02	D02	D03
	Ordering data	Ordering data	Ordering data
	Order No.	Order No.	Order No.
Free end	2 m 1620399 5 m 1620400 10 m 1620401	2 m 1620421 5 m 1620422 10 m 1620423	2 m 1620402 5 m 1620404 10 m 1620405
M23, 4+3+PE-pos., male	2 m 1620409 5 m 1620410 10 m 1620411		2 m 1620412 5 m 1620413 10 m 1620414

Cable information:

Type	Color	Structure	Sheath/core material	Assignment		Temperature range
D02 Servo	Orange	Shielded, 4x 1.5 + 2x 2x 0.75	PUR/TPM	1 - Black U 3 - Black V 4 - Black W	A - Black 5 (brake) B - Black 6 (brake) C - Black 7 (motor temp. +) D - Black 8 (motor temp. -)	Mobile: -20°C ... 60°C Fixed: -40°C ... 80°C
D03 Servo	Orange	Shielded, 4x 2.5 + 2x 2x 0.75	PUR/TPM	PE - Green-yellow		Mobile: -20°C ... 60°C Fixed: -40°C ... 80°C

M23, 4+3+PE-position,
female, standard,
250 V/630 V, 26 A



D03

Ordering data

Order No.

2 m	1620424
5 m	1620425
10 m	1620426

Sensor/actuator cabling

Assembled cables

Plastic-molded M40 power connectors



- Contact material gold-plated CuZn
- Flame-retardant TPU handle material
- CuZn or Gd-Zn knurl, nickel-plated
- IP67 degree of protection
- Connector head temperature range -40°C to +105°C
- Standard contact numbering
- M40 standard thread, SPEEDCON fast locking system on request

M40, 2+3+PE-position, female, standard, 250 V/630 V, 26 A

M40, 2+3+PE-position, female, standard, 250 V/630 V, 34 A

M40, 2+3+PE-position, female, standard, 250 V/630 V, 44 A



	C03		C04		C05	
	Ordering data		Ordering data		Ordering data	
	Order No.		Order No.	Order No.		Order No.
Free end						
	2 m	1619329	2 m	1620311	2 m	1620316
	5 m	1620309	5 m	1620313	5 m	1620317
	10 m	1620310	10 m	1620314	10 m	1620318
M40, 2+3+PE-pos., male						
	2 m	1620345	2 m	1620348	2 m	1620376
	5 m	1620346	5 m	1620349	5 m	1620377
	10 m	1620347	10 m	1620375	10 m	1620378
M40, 4+3+PE-pos., male						
						

Cable information:

Type	Color	Structure	Sheath/core material	Assignment	Temperature range	
C03 Servo	Orange	Shielded, 4 x 2.50 + 2 x 1.5	TPU/TPM	U - Black U V - Black V W - Black W PE - Green-yellow	+ - Black, (BR1) -- White, (BR2)	Mobile: -20°C ... 70°C Fixed: -50°C ... 80°C
C04 Servo	Orange	Shielded, 4 x 4.00 + 2 x 1.5	TPU/TPM			Mobile: -20°C ... 70°C Fixed: -50°C ... 80°C
C05 Servo	Orange	Shielded, 4 x 6.00 + 2 x 1.5	PUR/TPE			Mobile: -40°C ... 80°C Fixed: -50°C ... 90°C
C06 Servo	Orange	Shielded, 4 x 10.0 + 2 x 1.5	TPU/TPM			Mobile: -20°C ... 70°C Fixed: -50°C ... 80°C
D03 Servo	Orange	Shielded, 4 x 2.5 + 2 x 2 x 0.75	PUR/TPM	U - Black 1 V - Black 2 W - Black 3 PE - Green-yellow	+ - Black 7 (motor temp. +) -- Black 8 (motor temp. -) 1 - Black 5 (brake) 2 - Black 6 (brake)	Mobile: -20°C ... 60°C Fixed: -40°C ... 80°C
D04 Servo	Orange	Shielded, 4 x 4.0 + 2 x 1.5 + 2 x 1.0	PUR/TPM			Mobile: -30°C ... 80°C Fixed: -45°C ... 80°C
D05 Servo	Orange	Shielded, 4 x 6.0 + 2 x 1.5 + 2 x 1.0	PUR/TPM			Mobile: -30°C ... 60°C Fixed: -30°C ... 80°C
D06 Servo	Orange	Shielded, 4 x 10 + 2 x 1.5 + 2 x 1.0	PUR/TPM			Mobile: -20°C ... 60°C Fixed: -40°C ... 80°C

M40, 2+3+PE-position, female, standard, 250 V/630 V, 61 A



C06

Ordering data

Order No.

2 m 1620319
5 m 1620320
10 m 1620321

M40, 4+3+PE-position, female, standard, 250 V/630 V, 26 A



D03

Ordering data

Order No.

2 m 1620322
5 m 1620323
10 m 1620324

M40, 4+3+PE-position, female, standard, 250 V/630 V, 34 A



D04

Ordering data

Order No.

2 m 1620325
5 m 1620337
10 m 1620338

M40, 4+3+PE-position, female, standard, 250 V/630 V, 44 A



D05

Ordering data

Order No.

2 m 1620339
5 m 1620340
10 m 1620341

M40, 4+3+PE-position, female, standard, 250 V/630 V, 61 A



D06

Ordering data

Order No.

2 m 1620342
5 m 1620343
10 m 1620344

2 m 1620379
5 m 1620380
10 m 1620381

2 m 1620382
5 m 1620383
10 m 1620384

2 m 1620385
5 m 1620386
10 m 1620387

2 m 1620390
5 m 1620391
10 m 1620392

2 m 1620393
5 m 1620394
10 m 1620395

Sensor/actuator cabling

Assembled cables

Plastic-molded M23 hybrid connectors

- Transmission of signals, data (CAT5, 100 Mbps), and power
- Rated voltage: 630 V AC/850 V DC
- Contact material gold-plated CuZn
- Flame-retardant TPU handle material
- CuZn or Gd-Zn knurl, nickel-plated
- IP67 degree of protection
- Connector head temperature range -40°C to +105°C
- SPEEDCON fast locking system, M23 standard thread on request
- Angled version can be rotated

	M23, 4+4+4+PE-position, female, standard, 50 V/630 V, 26 A	M23, 4+4+4+PE-position, male, standard, 50 V/630 V, 26 A	M23, 4+4+4+PE-position, female, standard, 50 V/630 V, 26 A
			
	H00	H00	H00
	Ordering data	Ordering data	Ordering data
	Order No.	Order No.	Order No.
Free end 	2 m 1622224 5 m 1622225 10 m 1622226	2 m 1622227 5 m 1622228 10 m 1622229	2 m 1622230 5 m 1622231 10 m 1622232
M23, 4+4+4+PE-pos., male 	2 m 1622244 5 m 1622245 10 m 1622246		
M23, 4+4+4+PE-pos., male 	2 m 1622247 5 m 1622248 10 m 1622249		
M23, 4+4+4+PE-pos., male 			2 m 1622250 5 m 1622251 10 m 1622252

Cable information:

Type	Color	Structure	Sheath/core material	Assignment		Temperature range
H00 Hybrid	Orange	Shielded, (5 x 2.5 + 2 x (2 x 0.5) + (4 x AWG 22) C) C	PUR/TPE, polyolefin	A - Black BK1 (2.5 mm ²) B - Black BK2 (2.5 mm ²) C - Black BK3 (2.5 mm ²) D - Black BK4 (2.5 mm ²) PE - Green-yellow (2.5 mm ²)	1 - Brown BN (0.5 mm ²) 2 - Violet VT (0.5 mm ²) 3 - Black BK (0.5 mm ²) 4 - Green GN (0.5 mm ²) 5 - Blue BU (0.34 mm ²) 6 - Yellow YE (0.34 mm ²) 7 - White WH (0.34 mm ²) 8 - Orange OG (0.34 mm ²)	Mobile: -30°C ... 60°C Fixed: -40°C ... 80°C

M23, 4+4+4+PE-position,
male, standard,
50 V/630 V, 26 A



H00

Ordering data

Order No.

2 m	1622233
5 m	1622234
10 m	1622243

Sensor/actuator cabling

Assembled cables

Valve connectors with Zener diode, cable type: PUR

Notes:
For information about the cable qualities, see page 318

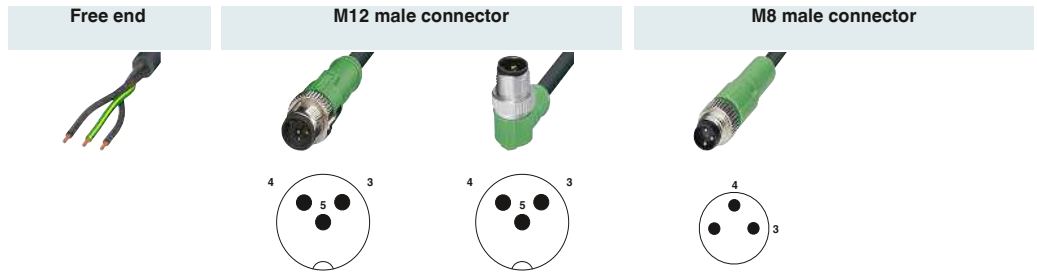

		Ordering data		Ordering data		Ordering data		Ordering data		Ordering data	
Type	Diagram	Length	Order No.	Length	Order No.	Length	Order No.	Length	Order No.	Length	Order No.
Type A		1.5 m	1434989	0.3 m	1434882	0.3 m	1434934	Variable	1405650		
		3 m	1434992	0.6 m	1434895	0.6 m	1434947				
		5 m	1435001	1.5 m	1434905	1.5 m	1434950				
		10 m	1435014	3 m	1434918	3 m	1434963				
		Variable	1435027	Variable	1434921	Variable	1434976				
Type B		1.5 m	1435386	0.3 m	1435289	0.3 m	1435331	Variable	1405651		
		3 m	1435399	0.6 m	1435292	0.6 m	1435344				
		5 m	1435409	1.5 m	1435302	1.5 m	1435357				
		10 m	1435412	3 m	1435315	3 m	1435360				
		Variable	1435425	Variable	1435328	Variable	1435373				
Type BI		1.5 m	1435234	0.3 m	1435137	0.3 m	1435182	Variable	1405652		
		3 m	1435247	0.6 m	1435140	0.6 m	1435195				
		5 m	1435250	1.5 m	1435153	1.5 m	1435205				
		10 m	1435263	3 m	1435166	3 m	1435218				
		Variable	1435276	Variable	1435179	Variable	1435221				
Type C		1.5 m	1435535	0.3 m	1435438	0.3 m	1435483	Variable	1405653		
		3 m	1435548	0.6 m	1435441	0.6 m	1435496				
		5 m	1435551	1.5 m	1435454	1.5 m	1435506				
		10 m	1435564	3 m	1435467	3 m	1435519				
		Variable	1435726	Variable	1435629	Variable	1435674				
Type CI		1.5 m	1435687	0.3 m	1435580	0.3 m	1435632	Variable	1405654		
		3 m	1435690	0.6 m	1435593	0.6 m	1435645				
		5 m	1435700	1.5 m	1435603	1.5 m	1435658				
		10 m	1435713	3 m	1435616	3 m	1435661				
		Variable	1435577	Variable	1435470	Variable	1435522				

Information for products with fixed cable length:

Products with fixed cable length are produced with the halogen-free PUR cable type and are available from stock.

Ordering data for type A, B, BI, C, CI valve connector cables with variable cable:

For a 4.5 m long sensor/actuator cable, PUR, halogen-free, black, type A valve connector with Zener diode, and a 3-pos. straight M12 male connector, the ordering data is as follows:

Order No.	Cable type	Length [m] Max. 40 m
1434921	PUR	4.5
Minimum order qty:	Increments:	
25 pcs.	0.2 ... 3 m = 0.1 m	
	> 3 m = 0.5 m	

Cable description	Cable type	M12				Color coding	Pin assignment M12
		M8	A	B(I)	C(I)		
PUR, halogen-free – black, 0.5 mm ²	PUR	x	x	x	x	BK1: 1, BK2: 2	4, 3
PUR, halogen-free – black, 1.0 mm ²	121	x	x			GNYE	5
PUR, halogen-free – yellow, 0.5 mm ²	240	x	x	x	x		
PUR, halogen-free – gray, 0.5 mm ²	280	x	x	x	x		
PUR, irradiated – orange, 0.5 mm ²	150	x	x	x	x		
PUR, highly flexible – gray, 0.5 mm ²	800	x	x	x	x		
PVC – black, 0.5 mm ²	PVC	x	x	x	x		
PVC – black, 0.75 mm ²	534	x	x	x	x		
PVC – gray, 0.5 mm ²	500	x	x	x	x	BU: 3, BN: 4	3, 4

Technical data

Connector	
Rated voltage	24 V AC / 24 V DC
Rated current	4 [A]
Contact material	CuSn
Material contact surface M12	Ni/Au
Material contact surface valve connector	Sn
Material of grip body	TPU
Material, knurls	Zinc die-cast, nickel-plated
Degree of protection	IP65 / IP67
Temperature data	
Male connector/female connector	-25 ... 90 [°C]
Valve connectors	-20 ... 85 [°C]

Valve connectors with Zener diode, cable type: PVC

Notes:
For information about the cable qualities, see page 318

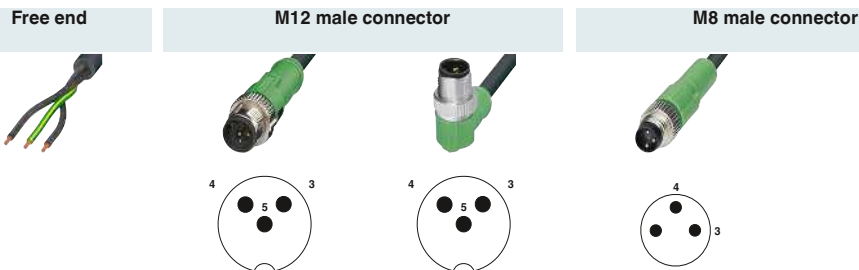

		Ordering data		Ordering data		Ordering data		Ordering data	
Type	Diagram	Length	Order No.	Length	Order No.	Length	Order No.	Length	Order No.
Type A		1.5 m	1438684	Variable	1434921	Variable	1434976	Variable	1405650
		3 m	1415905						
		5 m	1439502						
		10 m	1439492						
		Variable	1435027						
Type B		1.5 m	1415922	Variable	1435328	Variable	1435373	Variable	1405651
		3 m	1415923						
		5 m	1415924						
		10 m	1400610						
		Variable	1435425						
Type BI		1.5 m	1415929	Variable	1435179	Variable	1435221	Variable	1405652
		3 m	1400609						
		5 m	1415930						
		10 m	1400607						
		Variable	1435276						
Type C		1.5 m	1439162	Variable	1435629	Variable	1435674	Variable	1405653
		3 m	1439515						
		5 m	1439528						
		10 m	1439531						
		Variable	1435726						
Type CI		1.5 m	1439175	Variable	1435470	Variable	1435522	Variable	1405654
		3 m	1415939						
		5 m	1415940						
		10 m	1400605						
		Variable	1435577						

Information for products with fixed cable length:

Products with fixed cable length are produced with the PVC cable type and are available from stock.

Ordering data for type A, B, BI, C, CI valve connector cables with variable cable:

For a 4.5 m long sensor/actuator cable, PVC – black, type A valve connector with Zener diode, and a 3-pos. straight M12 male connector, the ordering data is as follows:

Order No.	Cable type	Length [m]
1434921	PVC	4.5
Minimum order qty: 25 pcs.		Increments: 0.2 ... 3 m = 0.1 m > 3 m = 0.5 m

Cable description	Cable type	M8	M12	A	B(I)	C(I)
PVC – black, 0.5 mm ²	PVC	x	x	x	x	x
PVC – black, 0.75 mm ²	534	x	x	x	x	x
PVC – gray, 0.5 mm ²	500	x	x	x	x	x
PUR, halogen-free – black, 0.5 mm ²	PUR	x	x	x	x	x
PUR, halogen-free – black, 1.0 mm ²	121	x	x			
PUR, halogen-free – yellow, 0.5 mm ²	240	x	x	x	x	x
PUR, halogen-free – gray, 0.5 mm ²	280	x	x	x	x	x
PUR, irradiated – orange, 0.5 mm ²	150	x	x	x	x	x
PUR, highly flexible – gray, 0.5 mm ²	800	x	x	x	x	x

Color coding		Pin assignment M12
BK1	1	4
BK2	2	3
GNYE		5

Color coding M8		Pin assignment M8
BU		3
BN		4

Technical data	
Connector	
Rated voltage	24 V AC / 24 V DC
Rated current	4 [A]
Contact material	CuSn
Material contact surface M12	Ni/Au
Material contact surface valve connector	Sn
Material of grip body	TPU
Material, knurls	Zinc die-cast, nickel-plated
Degree of protection	IP65 / IP67
Temperature data	
Male connector/female connector	[°C] -25 ... 90
Valve connectors	[°C] -20 ... 85

Sensor/actuator cabling

Assembled cables

Valve connectors with 24 V varistor, cable type: PUR

Notes:
For information about the cable qualities, see page 318

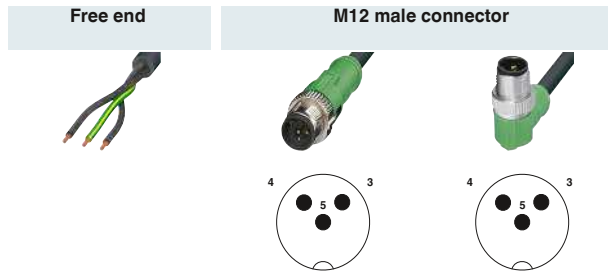

		Ordering data		Ordering data		Ordering data	
Type	Diagram	Length	Order No.	Length	Order No.	Length	Order No.
Type A		1.5 m	1443103	Variable	1400874	Variable	1400875
		3 m	1443116				
		5 m	1443129				
		10 m	1443132				
		Variable	1400876				
Type B		1.5 m	1443145	Variable	1400880	Variable	1400881
		3 m	1443158				
		5 m	1443161				
		10 m	1443174				
		Variable	1400882				
Type BI		1.5 m	1443187	Variable	1400877	Variable	1400878
		3 m	1443190				
		5 m	1443200				
		10 m	1443213				
		Variable	1400879				
Type C		1.5 m	1443226	Variable	1400892	Variable	1400893
		3 m	1443239				
		5 m	1443242				
		10 m	1443255				
		Variable	1400894				
Type CI		1.5 m	1443268	Variable	1400889	Variable	1400890
		3 m	1443271				
		5 m	1443284				
		10 m	1443297				
		Variable	1400891				

Information for products with fixed cable length:

Products with fixed cable length are produced with the halogen-free PUR cable type and are available from stock.

Ordering data for type A, B, BI, C, CI valve connector cables with variable cable:

For a 4.5 m long sensor/actuator cable, PUR, halogen-free, black, type B valve connector with 24 V varistor, and a 3-pos. straight M12 male connector, the ordering data is as follows:

Order No.	Cable type	Length [m] Max. 40 m
1400880	PUR	4.5
Minimum order qty: 25 pcs.		Increments: 0.2 ... 3 m = 0.1 m > 3 m = 0.5 m

Cable description	Cable type
PUR, halogen-free – black, 0.5 mm ²	PUR
PUR, halogen-free – black, 1.0 mm ² Type A valve connector only	121
PUR, halogen-free – yellow, 0.5 mm ²	240
PUR, halogen-free – gray, 0.5 mm ²	280
PUR, irradiated – orange, 0.5 mm ²	150
PUR, highly flexible – gray, 0.5 mm ²	800
PVC – black, 0.5 mm ²	PVC
PVC – black, 0.75 mm ²	534
PVC – gray, 0.5 mm ²	500

Color coding		Pin assignment
BK1	1	4
BK2	2	3
GNYE		5

Technical data	
Connector	
Rated voltage	24 V AC / 24 V DC
Rated current	4
Contact material	CuSn
Material contact surface M12	Ni/Au
Material contact surface valve connector	Sn
Material of grip body	TPU
Material, knurls	Zinc die-cast, nickel-plated
Degree of protection	IP65 / IP67
Temperature data	
Male connector/female connector	[-25 ... 90
Valve connectors	[-20 ... 85

Valve connectors with 24 V varistor, cable type: PVC

Notes:
For information about the cable qualities, see page 318

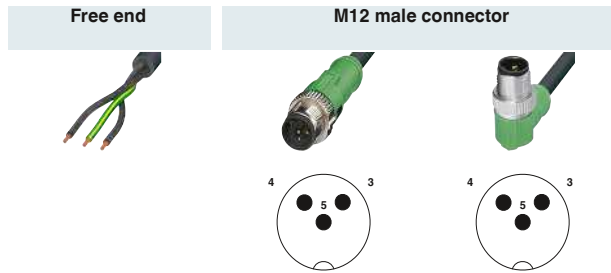

		Ordering data		Ordering data		Ordering data	
		Order No.		Order No.		Order No.	
Type A 		1.5 m	1415908				
		3 m	1415909				
		5 m	1415910				
		10 m	1415911				
		Variable	1400876	Variable	1400874	Variable	1400875
Type B 		1.5 m	1415925				
		3 m	1415926				
		5 m	1415927				
		10 m	1415928				
		Variable	1400882	Variable	1400880	Variable	1400881
Type BI 		1.5 m	1415931				
		3 m	1415932				
		5 m	1415933				
		10 m	1415934				
		Variable	1400879	Variable	1400877	Variable	1400878
Type C 		1.5 m	1415935				
		3 m	1415936				
		5 m	1415937				
		10 m	1415938				
		Variable	1400894	Variable	1400892	Variable	1400893
Type CI 		1.5 m	1415941				
		3 m	1415942				
		5 m	1415943				
		10 m	1415944				
		Variable	1400891	Variable	1400889	Variable	1400890

Information for products with fixed cable length:

Products with fixed cable length are produced with the PVC cable type and are available from stock.

Ordering data for type A, B, BI, C, CI valve connector cables with variable cable:

For a 4.5 m long sensor/actuator cable, PVC – black, type B valve connector with 24 V varistor, and a 3-pos. straight M12 male connector, the ordering data is as follows:

Order No.	Cable type	Length [m] Max. 40 m
1400880	PVC	4.5
Minimum order qty: 25 pcs.		Increments: 0.2 ... 3 m = 0.1 m > 3 m = 0.5 m

Cable description	Cable type	Color coding	Pin assignment
PVC – black, 0.5 mm ²	PVC	BK1 1, BK2 2	4, 3
PVC – black, 0.75 mm ²	534	GNYE	5
PVC – gray, 0.5 mm ²	500		
PUR, halogen-free – black, 0.5 mm ²	PUR		
PUR, halogen-free – black, 1.0 mm ² Type A valve connector only	121		
PUR, halogen-free – yellow, 0.5 mm ²	240		
PUR, halogen-free – gray, 0.5 mm ²	280		
PUR, irradiated – orange, 0.5 mm ²	150		
PUR, highly flexible – gray, 0.5 mm ²	800		

Technical data

Connector

Rated voltage		24 V AC / 24 V DC
Rated current	[A]	4
Contact material		CuSn
Material contact surface M12		Ni/Au
Material contact surface valve connector		Sn
Material of grip body		TPU
Material, knurls		Zinc die-cast, nickel-plated
Degree of protection		IP65 / IP67
Temperature data		
Male connector/female connector	[°C]	-25 ... 90
Valve connectors	[°C]	-20 ... 85

Sensor/actuator cabling

Assembled cables

Valve connectors with 230 V varistor, cable type: PUR

Notes:
For information about the cable qualities, see page 318

Free end



Type A



Ordering data

	Order No.
1.5 m	1402985
3 m	1400694
5 m	1400648
10 m	1402986

Technical data

		Connector
Rated voltage		230 V AC / 230 V DC
Rated current	[A]	4
Material contact surface valve connector		Sn
Degree of protection		IP65 / IP67
Temperature data		
Valve connectors	[°C]	-20 ... 85

**Valve connectors
with 230 V varistor,
cable type: PVC**

Free end



Notes:

For information about the cable qualities, see page 318

Ordering data

Type A



	Order No.
1.5 m	1415912
3 m	1415913
5 m	1415914
10 m	1415915

Technical data

Connector

Rated voltage		230 V AC / 230 V DC
Rated current	[A]	4
Material contact surface valve connector		Sn
Degree of protection		IP65 / IP67
Temperature data		
Valve connectors	[°C]	-20 ... 85

Sensor/actuator cabling

Assembled cables





Valve connectors with energy-reducing function, 1 A

Notes:
For information about the cable qualities, see page 318

Free end
1 A



Ordering data

Type	Order No.
Type A 	1.5 m 1413115
	3 m 1413114
	5 m 1413116
	10 m 1413118
Type B 	1.5 m 1401294
	3 m 1401295
	5 m 1401338
	10 m 1401339
Type BI 	1.5 m 1401340
	3 m 1401350
	5 m 1401358
	10 m 1401359
Type C 	1.5 m 1401434
	3 m 1401435
	5 m 1401448
	10 m 1401465
Type CI 	1.5 m 1401466
	3 m 1401542
	5 m 1401544
	10 m 1401617

Technical data

		Connector
Rated voltage		24 V DC ±20%
Rated current	[A]	1
Material contact surface valve connector		Ag
Degree of protection		IP67
Temperature data		
Valve connectors	[°C]	-25 ... 80



Valve connectors with energy-reducing function, 4 A



Notes:

For information about the cable qualities, see page 318

Ordering data

Type A	Order No.
 	1.5 m 1400827
	3 m 1401131
	5 m 1401136
	10 m 1401168

Technical data

		Connector
Rated voltage		24 V DC ±20%
Rated current	[A]	4
Material contact surface valve connector		Ag
Degree of protection		IP67
Temperature data		
Valve connectors	[°C]	-25 ... 80

Sensor/actuator cabling

Assembled cables

Valve connectors with freewheeling diode, cable type: PUR

Notes:

For information about the cable qualities, see page 318

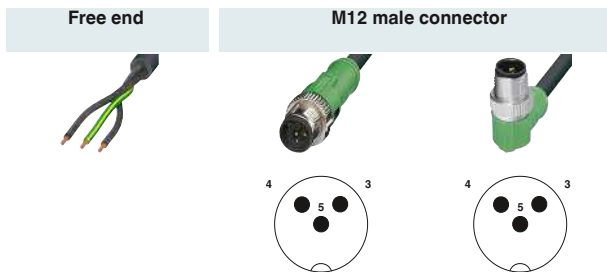

Type A	Ordering data	Ordering data		Ordering data	
		Order No.	Order No.	Order No.	Order No.
 	1.5 m	1400589			
	3 m	1400588			
	5 m	1400798			
	10 m	1400799			
	Variable	1417832	Variable	1417833	Variable

Information for products with fixed cable length:

Products with fixed cable length are produced with the halogen-free PUR cable type and are available from stock.

Ordering data for type A valve connector cables with variable cable:

For a 4.5 m long sensor/actuator cable, PUR, halogen-free, black, type A valve connector with freewheeling diode, and a 3-pos. straight M12 male connector, the ordering data is as follows:

Order No.	Cable type	Length [m] Max. 40 m
1417833	PUR	4.5
Minimum order qty:		Increments:
25 pcs.		0.2 ... 3 m = 0.1 m > 3 m = 0.5 m

Cable description	Cable type	Color coding	Pin assignment
PUR, halogen-free – black, 0.5 mm ²	PUR	BK1 1	4
PUR, halogen-free – black, 1.0 mm ² Type A valve connector only	121	BK2 2	3
PUR, halogen-free – yellow, 0.5 mm ²	240	GNYE	5
PUR, halogen-free – gray, 0.5 mm ²	280		
PUR, irradiated – orange, 0.5 mm ²	150		
PUR, highly flexible – gray, 0.5 mm ²	800		
PVC – black, 0.5 mm ²	PVC		
PVC – black, 0.75 mm ²	534		
PVC – gray, 0.5 mm ²	500		



Technical data

Connector	
Rated voltage	24 V DC
Rated current [A]	2
Contact material	CuSn
Material contact surface M12	Ni/Au
Material contact surface valve connector	Sn
Material of grip body	TPU
Material, knurls	Zinc die-cast, nickel-plated
Degree of protection	IP65 / IP67
Temperature data	
Male connector/female connector [°C]	-25 ... 90
Valve connectors [°C]	-20 ... 85

Valve connectors with freewheeling diode, cable type: PVC

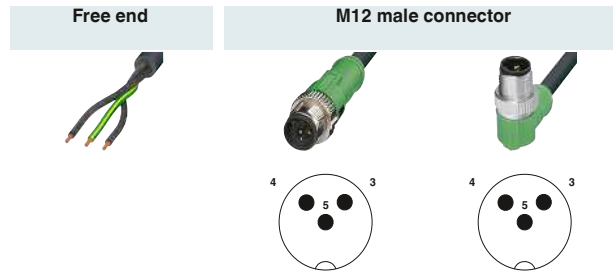
Notes:
For information about the cable qualities, see page 318



Type A	Ordering data	Ordering data		Ordering data	
		Order No.	Order No.	Order No.	Order No.
 	1.5 m	1415916			
	3 m	1415917			
	5 m	1415918			
	10 m	1415919			
	Variable	1417832	Variable	1417833	Variable

Information for products with fixed cable length:

Products with fixed cable length are produced with the PVC cable type and are available from stock.

Ordering data for type A valve connector cables with variable cable:

For a 4.5 m long sensor/actuator cable, PVC – black, type A valve connector with freewheeling diode, and a 3-pos. straight M12 male connector, the ordering data is as follows:

Order No.	Cable type	Length [m] Max. 40 m
1417833	PVC	4.5
Minimum order qty: 25 pcs.		Increments: 0.2 ... 3 m = 0.1 m > 3 m = 0.5 m

Cable description	Cable type	Color coding	Pin assignment
PVC – black, 0.5 mm ²	PVC	BK1 1	4
PVC – black, 0.75 mm ²	534	BK2 2	3
PVC – gray, 0.5 mm ²	500	GNYE	5
PUR, halogen-free – black, 0.5 mm ²	PUR		
PUR, halogen-free – black, 1.0 mm ² Type A valve connector only	121		
PUR, halogen-free – yellow, 0.5 mm ²	240		
PUR, halogen-free – gray, 0.5 mm ²	280		
PUR, irradiated – orange, 0.5 mm ²	150		
PUR, highly flexible – gray, 0.5 mm ²	800		

Technical data

Connector	
Rated voltage	24 V DC
Rated current [A]	2
Contact material	CuSn
Material contact surface M12	Ni/Au
Material contact surface valve connector	Sn
Material of grip body	TPU
Material, knurls	Zinc die-cast, nickel-plated
Degree of protection	IP65 / IP67
Temperature data	
Male connector/female connector	[°C] -25 ... 90
Valve connectors	[°C] -20 ... 85

Sensor/actuator cabling

Assembled cables

Valve connectors without wiring, cable type: PUR

Notes:
For information about the cable qualities, see page 318

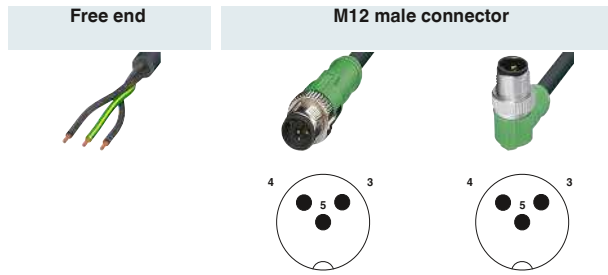

		Ordering data		Ordering data		Ordering data	
Type	Diagram	Order No.	Order No.	Order No.	Order No.	Order No.	Order No.
Type A		1.5 m	1402983				
		3 m	1439544				
		5 m	1402984				
		10 m	1400732				
		Variable	1400897	Variable	1400895	Variable	1400896
Type B		Variable	1400909	Variable	1400903	Variable	1400905
Type BI		5 m	1439065				
		10 m	1438862				
		Variable	1400902	Variable	1400900	Variable	1400901
Type C		5 m	1400814				
		10 m	1400641				
		Variable	1400921	Variable	1400919	Variable	1400920
Type CI		Variable	1400918	Variable	1400916	Variable	1400917

Information for products with fixed cable length:

Products with fixed cable length are produced with the halogen-free PUR cable type and are available from stock.

Ordering data for type A, B, BI, C, CI valve connector cables with variable cable:

For a 4.5 m long sensor/actuator cable, PUR, halogen-free, black, unwired type C valve connector, and a 3-pos. straight M12 male connector, the ordering data is as follows:

Order No.	Cable type	Length [m] Max. 40 m
1400919	PUR	4.5
Minimum order qty:		Increments: 0.2 ... 3 m = 0.1 m > 3 m = 0.5 m
25 pcs.		

Cable description	Cable type
PUR, halogen-free – black, 0.5 mm ²	PUR
PUR, halogen-free – black, 1.0 mm ² Type A valve connector only	121
PUR, halogen-free – yellow, 0.5 mm ²	240
PUR, halogen-free – gray, 0.5 mm ²	280
PUR, irradiated – orange, 0.5 mm ²	150
PUR, highly flexible – gray, 0.5 mm ²	800
PVC – black, 0.5 mm ²	PVC
PVC – black, 0.75 mm ²	534
PVC – gray, 0.5 mm ²	500

Color coding	Pin assignment
BK1 1	4
BK2 2	3
GNYE	5

	Technical data	Technical data
	Free end	Connector
Rated voltage	230 V AC / 230 V DC	48 V AC / 60 V DC
Rated current [A]	6	4
Contact material	-	CuSn
Material contact surface M12	-	Ni/Au
Material contact surface valve connector	Sn	Sn
Material of grip body	-	TPU
Material, knurls	-	Zinc die-cast, nickel-plated
Degree of protection	IP65 / IP67	IP65 / IP67
Temperature data		
Male connector/female connector [°C]	- ... -	-25 ... 90
Valve connectors [°C]	-20 ... 85	-20 ... 85

Valve connectors without wiring, cable type: PVC

Notes:
For information about the cable qualities, see page 318

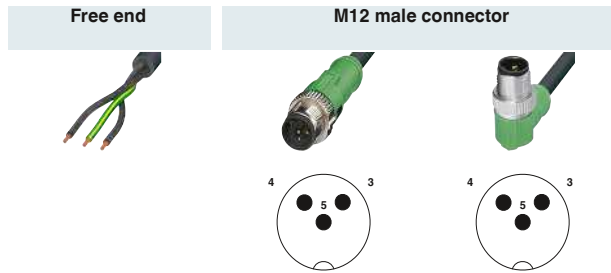

		Ordering data		Ordering data		Ordering data	
		Order No.	Order No.	Order No.	Order No.	Order No.	Order No.
Type A		1.5 m 3 m 5 m 10 m Variable	1415920 1415921 1402977 1402978 1400897	Variable	1400895	Variable	1400896
Type B		Variable	1400909	Variable	1400903	Variable	1400905
Type BI		Variable	1400902	Variable	1400900	Variable	1400901
Type C		Variable	1400921	Variable	1400919	Variable	1400920
Type CI		Variable	1400918	Variable	1400916	Variable	1400917

Information for products with fixed cable length:

Products with fixed cable length are produced with the PVC cable type and are available from stock.

Ordering data for type A, B, BI, C, CI valve connector cables with variable cable:

For a 4.5 m long sensor/actuator cable, PVC – black, unwired type C valve connector, and a 3-pos. straight M12 male connector, the ordering data is as follows:

Order No.	Cable type	Length [m] Max. 40 m
1400919	PVC	4.5
Minimum order qty: 25 pcs.		Increments: 0.2 ... 3 m = 0.1 m > 3 m = 0.5 m

Cable description	Cable type
PVC – black, 0.5 mm ²	PVC
PVC – black, 0.75 mm ²	534
PVC – gray, 0.5 mm ²	500
PUR, halogen-free – black, 0.5 mm ²	PUR
PUR, halogen-free – black, 1.0 mm ² Type A valve connector only	121
PUR, halogen-free – yellow, 0.5 mm ²	240
PUR, halogen-free – gray, 0.5 mm ²	280
PUR, irradiated – orange, 0.5 mm ²	150
PUR, highly flexible – gray, 0.5 mm ²	800

Color coding		Pin assignment
BK1	1	4
BK2	2	3
GNYE		5

	Technical data	
	Free end	Connector
Rated voltage	230 V AC / 230 V DC	48 V AC / 60 V DC
Rated current	6	4
Contact material	-	CuSn
Material contact surface M12	-	Ni/Au
Material contact surface valve connector	Sn	Sn
Material of grip body	-	TPU
Material, knurls	-	Zinc die-cast, nickel-plated
Degree of protection	IP65 / IP67	IP65 / IP67
Temperature data		
Male connector/female connector	[°C] - ... -	-25 ... 90
Valve connectors	[°C] -20 ... 85	-20 ... 85

Sensor/actuator cabling

Assembled cables

Valve connectors, pressure switches with 2 LEDs, cable type: PUR

Notes:

For information about the cable qualities, see page 318

Free end



M12 male connector

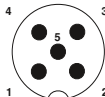

Type AD	Ordering data		Ordering data		Ordering data	
		Order No.		Order No.		Order No.
 	1.5 m	1435085	0.3 m	1435030		
	3 m	1435098	0.6 m	1435043		
	5 m	1435108	1.5 m	1435056		
	10 m	1435111	3 m	1435069		
	Variable	1435124	Variable	1435072		

Information for products with fixed cable length:

Products with fixed cable length are produced with the halogen-free PUR cable type and are available from stock.

Ordering data for type AD valve connector cables with 2 LEDs and variable cable:

For a 4.5 m long sensor/actuator cable, PUR, halogen-free, black, type AD valve connector with 2 LEDs, and a 5-pos. straight M12 connector, the ordering data is as follows:

Order No.	Cable type	Length [m]
1435072	PUR	4.5
Minimum order amount:		Increments:
25 pcs.		0.2 ... 3 m = 0.1 m
		> 3 m = 0.5 m

Cable description	Cable type	Color coding	Pin assignment
PUR, halogen-free – black, 0.5 mm ²	PUR	BK1 1	1
PUR, halogen-free – yellow, 0.5 mm ²	240	BK2 2	2
PUR, halogen-free – gray, 0.5 mm ²	280	BK3 3	4
		BK2 4	3
		GNYE	5
PUR irradiated – orange, 0.5 mm ²	150		
PUR highly flexible – gray, 0.5 mm ²	800		
PVC – black, 0.5 mm ²	PVC		
PVC – black, 0.75 mm ²	534		
PVC – gray, 0.5 mm ²	500		

Technical data

Connector	
Rated voltage	24 V AC / 24 V DC
Rated current	4 [A]
Contact material	CuSn
Material contact surface M12	Ni/Au
Material contact surface valve connector	Sn
Material of grip body	TPU
Material, knurls	Zinc die-cast, nickel-plated
Degree of protection	IP65 / IP67
Temperature data	
Male connector/female connector	-25 ... 90 [°C]
Valve connectors	-20 ... 85 [°C]

Valve connectors, pressure switches with 2 LEDs, cable type: PVC

Notes:
For information about the cable qualities, see page 318

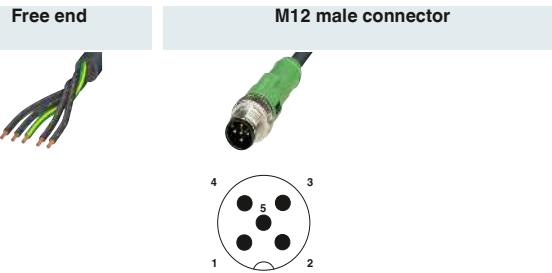

Type AD	Ordering data		Ordering data	
	Order No.	Order No.	Order No.	Order No.
 	1.5 m	1415945		
	3 m	1415946		
	5 m	1438639		
	10 m	1438671		
	Variable	1435124	Variable	1435072

Information for products with fixed cable length:

Products with fixed cable length are produced with the PVC cable type and are available from stock.

Ordering data for type AD valve connector cables with 2 LEDs and variable cable:

For a 4.5 m long sensor/actuator cable, PVC - black, type AD valve connector with 2 LEDs, and a 5-pos. straight M12 connector, the ordering data is as follows:

Order No.	Cable type	Length [m]
1435072	PVC	4.5
Minimum order amount:		Increments:
25 pcs.		0.2 ... 3 m = 0.1 m
		> 3 m = 0.5 m

Cable description	Cable type	Color coding	Pin assignment
PVC – black, 0.5 mm ²	PVC	BK1 1	1
PVC – black, 0.75 mm ²	534	BK2 2	2
PVC – gray, 0.5 mm ²	500	BK3 3	4
		BK2 4	3
		GNYE	5
PUR, halogen-free – black, 0.5 mm ²	PUR		
PUR, halogen-free – yellow, 0.5 mm ²	240		
PUR, halogen-free – gray, 0.5 mm ²	280		
PUR irradiated – orange, 0.5 mm ²	150		
PUR highly flexible – gray, 0.5 mm ²	800		

Technical data	
Connector	
Rated voltage	24 V AC / 24 V DC
Rated current [A]	4
Contact material	CuSn
Material contact surface M12	Ni/Au
Material contact surface valve connector	Sn
Material of grip body	TPU
Material, knurls	Zinc die-cast, nickel-plated
Degree of protection	IP65 / IP67
Temperature data	
Male connector/female connector	[°C] -25 ... 90
Valve connectors	[°C] -20 ... 85



Sensor/actuator cabling

Assembled cables

Valve connectors, pressure switches without wiring

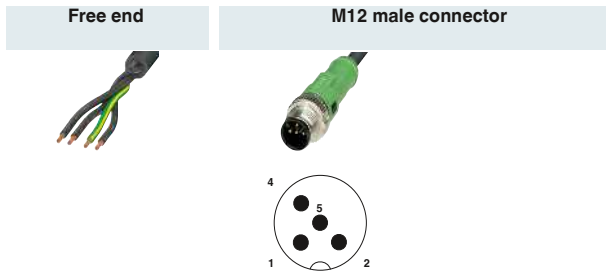
Notes:
For information about the cable qualities, see page 318



Type AD	Ordering data		Ordering data		Ordering data	
	3 m	Order No.	Order No.	Order No.	Order No.	Order No.
		1438956				
	Variable	1400899	Variable	1400898		

Ordering data for unwired type AD valve connector cables with variable cable:

For a 4.5 m long sensor/actuator cable, PUR, halogen-free, black, unwired type AD valve connector, and a 4-pos. straight M12 connector, the ordering data is as follows:

Cable description	Cable type	Color coding	Pin assignment
PUR, halogen-free – black, 0.5 mm ²	PUR	BK1 1	1
PVC – black, 0.5 mm ²	PVC	BK2 2	2
PVC – black, 0.75 mm ²	534	BK3 3	4
		GNYE 3	5

Order No.	Cable type	Length [m]
1400898	PUR	4.5
Minimum order amount:		40 m, maximum
25 pcs.		Increments: 0.2 ... 3 m = 0.1 m > 3 m = 0.5 m

	Technical data	
	Free end	Connector
Rated voltage	230 V AC / 230 V DC	48 V AC / 60 V DC
Rated current [A]	4	4
Contact material	-	CuSn
Material contact surface M12	-	Ni/Au
Material contact surface valve connector	Sn	Sn
Material of grip body	-	TPU
Material, knurls	-	Zinc die-cast, nickel-plated
Degree of protection	IP65 / IP67	IP65 / IP67
Temperature data		
Male connector/female connector [°C]	- ... -	-25 ... 90
Valve connectors [°C]	-20 ... 85	-20 ... 85

Double valve connectors with Zener diode

Notes:
For information about the cable qualities, see page 318

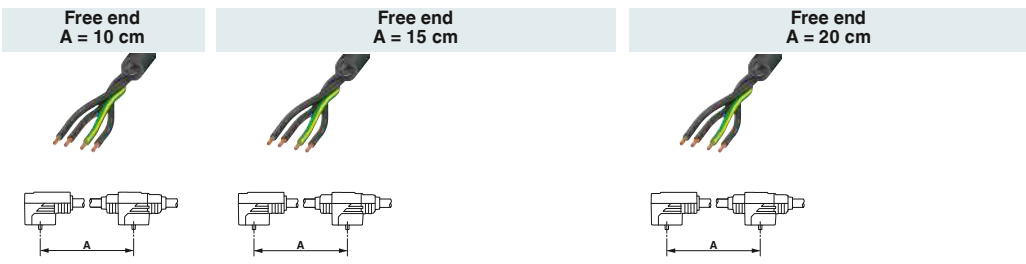

		Ordering data		Ordering data		Ordering data		Ordering data	
		Order No.	Order No.	Order No.	Order No.	Order No.	Order No.	Order No.	Order No.
Type A  	1.5 m	1457982	1.5 m	1458020	1.5 m	1458062			
	3 m	1457995	3 m	1458033	3 m	1458075			
	5 m	1458004	5 m	1458046	5 m	1458088			
	10 m	1458017	10 m	1458059	10 m	1458091			
Type B  	1.5 m	1458169	1.5 m	1458208		1.5 m	1458240		
	3 m	1458172	3 m	1458211		3 m	1458253		
	5 m	1458185	5 m	1458224		5 m	1458266		
	10 m	1458198	10 m	1458237		10 m	1458279		
Type BI  	1.5 m	1458347	1.5 m	1458389		1.5 m	1458428		
	3 m	1458350	3 m	1458392		3 m	1458431		
	5 m	1458363	5 m	1458402		5 m	1458444		
	10 m	1458376	10 m	1458415		10 m	1458457		

Technical data	
Connector	
Rated voltage	24 V AC / 24 V DC
Rated current [A]	4
Material contact surface valve connector	Sn
Degree of protection	IP65 / IP67
Temperature data	
Valve connectors [°C]	-25 ... 85

Sensor/actuator cabling

Assembled cables

Valve connectors, Deutsch DT06 and DT04, without wiring

Notes:
For information about the cable qualities, see page 318



	Ordering data		Ordering data		Ordering data		Ordering data		Ordering data	
Free end	Order No.	Order No.	Order No.	Order No.	Order No.	Order No.	Order No.	Order No.	Order No.	Order No.
			1.5 m	1414999	1.5 m	1415012	1.5 m	1415030	3 m	1415000
			3 m	1415000	3 m	1415013	3 m	1415031	5 m	1415001
			5 m	1415001	5 m	1415014	5 m	1415032	10 m	1415002
			10 m	1415002	10 m	1415015	10 m	1415033		
Female connector, 2-pos.			1.5 m	1410723	0.3 m	1414991				
			3 m	1410724	0.6 m	1414992				
			5 m	1410726	1.5 m	1414993				
			10 m	1410727	3 m	1414994				
Female connector, 3-pos.			1.5 m	1414995			0.3 m	1415003		
			3 m	1414996			0.6 m	1415004		
			5 m	1414997			1.5 m	1415005		
			10 m	1414998			3 m	1415006		
Female connector, 4-pos.			1.5 m	1415007			0.3 m	1415016		
			3 m	1415008			0.6 m	1415017		
			5 m	1415010			1.5 m	1415019		
			10 m	1415011			3 m	1415025		
Female connector, 6-pos.			1.5 m	1415026					0.3 m	1415035
			3 m	1415027					0.6 m	1415036
			5 m	1415028					1.5 m	1415037
			10 m	1415029					3 m	1415038

Technical data

		Connector
Rated voltage		48 V AC / 48 V DC
Rated current	[A]	8
Contact material		Cu alloy
Material contact surface M12		Nickel-plated
Material of grip body		PA
Material, knurls		not available
Degree of protection		IP67
Temperature data		
Male connector/female connector	[°C]	-20 ... 85

**Valve connectors,
Deutsch DT06-2S with LED**

Free end



Notes:

For information about the cable qualities, see page 318

Ordering data

Female, 2-pos.

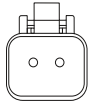

	Order No.
1.5 m	1410728
3 m	1410729
5 m	1410730
10 m	1410731

Technical data

Connector

Rated voltage		24 V AC / 24 V DC
Rated current	[A]	8
Contact material		Cu alloy
Material contact surface M12		Nickel-plated
Material of grip body		PA
Material, knurls		not available
Degree of protection		IP67
Temperature data		
Male connector/female connector	[°C]	-20 ... 85

Assembled cables

Valve connectors, Deutsch DT06-2S with freewheeling diode

Notes:

For information about the cable qualities, see page 318

Free end



Ordering data

Female connector, 2-pos.

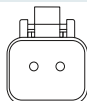

	Order No.
1.5 m	1410732
3 m	1410733
5 m	1410734
10 m	1410735



Technical data

		Connector
Rated voltage		24 V AC / 24 V DC
Rated current	[A]	3
Contact material		Cu alloy
Material contact surface M12		Nickel-plated
Material of grip body		PA
Material, knurls		not available
Degree of protection		IP67
Temperature data		
Male connector/female connector	[°C]	-20 ... 85

**Valve connectors,
Superseal**

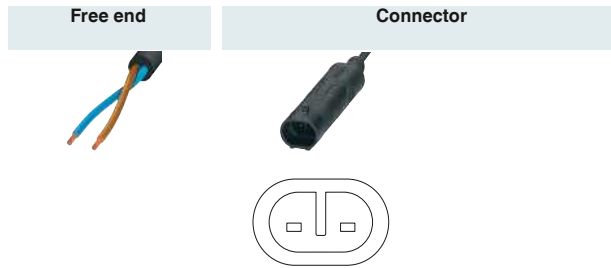
Notes:
For information about the cable qualities, see page 318



Free end	Ordering data		Ordering data		Ordering data	
	Order No.	Order No.	Order No.	Order No.	Order No.	Order No.
		1.5 m	1410752			
		3 m	1410753			
		5 m	1410755			
		10 m	1410756			
Female connector, straight 		1.5 m	1410748	0.3 m	1410757	
		3 m	1410749	0.6 m	1410759	
		5 m	1410750	1.5 m	1410760	
		10 m	1410751	3 m	1410761	

Technical data	
Connector	
Rated voltage	24 V AC / 24 V DC
Rated current [A]	8
Contact material	CuZn
Material of grip body	PA
Material, knurls	not available
Degree of protection	IP67
Temperature data	
Male connector/female connector [°C]	-20 ... 85

Sensor/actuator cabling

Distributors and adapters

M8 Y cable, 3-pos., two cable outlets

M8 Y male connector



Notes:

For information about the cable qualities, see page 318

Ordering data

Free end		Order No.
	1.5 m	1458622
	3 m	1458635
	5 m	1458648
	10 m	1458651
M8 female connector, straight 	0.3 m	1458664
	0.6 m	1458677
	1.5 m	1458680
	3 m	1458693
M8 female connector, angled 	0.3 m	1458703
	0.6 m	1458716
	1.5 m	1458729
	3 m	1458732
M8 female connector, angled, with 2 LEDs 	0.3 m	1458745
	0.6 m	1458758
	1.5 m	1458761
	3 m	1458774

Cable description	Cable type	Color coding	Pin assignment, 3-pos.	
			Male	Female
PUR, halogen-free - black	PUR	BN	1	1
		BK	2 + 4	4
		BU	3	3

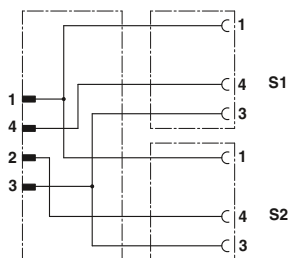

Contact assignment of the M8 connector and the M8 female connectors

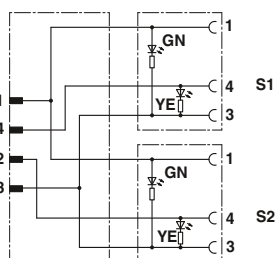

Contact assignment of the M8 connector and the M8 female connectors, with LEDs

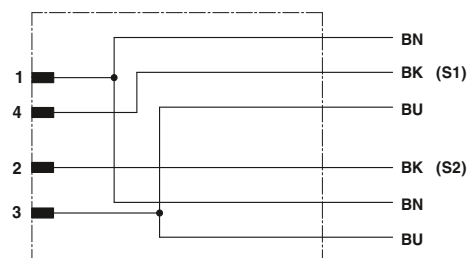

Contact assignment of the M8 Y connector

	Technical data	
	Y-M8	Y-M8 with LEDs
Rated voltage	48 V AC / 60 V DC	24 V / 24 V DC
Rated current [A]	4	4
Contact material	CuSn	CuSn
Contact surface material	Ni/Au	Ni/Au
Material of grip body	TPU, hardly inflammable, self-extinguishing	TPU, hardly inflammable, self-extinguishing
Material, knurls	Zinc die-cast, nickel-plated	Zinc die-cast, nickel-plated
M8 circular connector in accordance with:	IEC 61076-2-104	IEC 61076-2-104
Degree of protection	IP65 / IP67 / IP68	IP65 / IP67 / IP68
Temperature data		
Male connector/female connector [°C]	-25 ... 90	-25 ... 90

M12 Y distributors, 4-pos., one cable outlet

Notes:
 For information about the cable qualities, see page 318
 Further combinations on request.

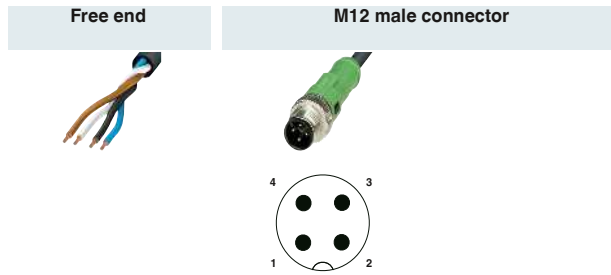

Y connector with 2 x M12 female connectors	Ordering data		Ordering data		Ordering data	
		Order No.		Order No.		Order No.
	1.5 m	1436165	0.3 m	1436204		
	3 m	1436178	0.6 m	1436217		
	5 m	1436181	1.5 m	1436220		
	10 m	1436194	3 m	1436233		

Cable description	Cable type	Suitable for:	Color coding	Pin assignment		
				M12 4-pos.	S1	M12-Y S2
PUR, halogen-free - black	PUR	M12 4-pos.	BN	1	1	1
			BK	4	4	-
			WH	2	-	4
			BU	3	3	3

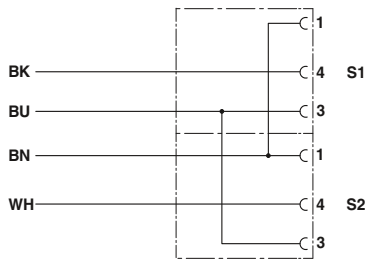

Contact assignment: Y-distributor to free end

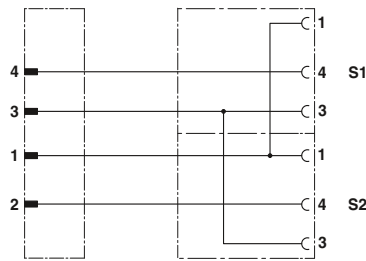

Contact assignment: Y-distributor to M12 SPEEDCON

Technical data	
Y-M12	
Rated voltage	48 V AC / 60 V DC
Rated current [A]	4
Contact material	CuSn
Contact surface material	Ni/Au
Contact carrier material	TPU GF
M12 circular connector in accordance with:	IEC 61076-2-101
Degree of protection	IP65 / IP67
Temperature data	
Male connector/female connector	-25 ... 90 [°C]

Sensor/actuator cabling

Distributors and adapters

M12 Y-cable, 4-pos., two cable outlets

Notes:

For information about the cable qualities, see page 318

M12 Y male connector

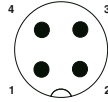

Ordering data

Free end		Order No.
	1.5 m	1669686
	3 m	1669699
	5 m	1669754
	10 m	1694473
	Variable	1697357
M8 female connector, straight 		
	0.3 m	1671331
	0.6 m	1671344
	1.5 m	1671357
3 m	1671360	
Variable	1697399	
M8 female connector, angled 		
	0.3 m	1671373
	0.6 m	1671386
	1.5 m	1671399
3 m	1671409	
Variable	1697409	
M8 female connector, angled, with 2 LEDs 		
	0.3 m	1671412
	0.6 m	1671425
	1.5 m	1671438
3 m	1671441	
Variable	1697412	
M12 female connector, straight 		
Variable	1699766	
M12 female connector, angled 		
Variable	1506419	
M12 female connector, straight, pin 2 - 4 bridged 		
	0.3 m	1668959
	0.6 m	1668962
	1.5 m	1668975
3 m	1668988	
Variable	1697360	
M12 female connector, angled, pin 2 - 4 bridged 		
	0.3 m	1668991
	0.6 m	1669000
	1.5 m	1669013
3 m	1669026	
Variable	1697373	
M12 female connector, angled, with LED, pin 2 - 4 bridged 		
	0.3 m	1669039
	0.6 m	1669042
	1.5 m	1669055
3 m	1669068	
Variable	1697386	

Information for products with fixed cable length:

Products with fixed cable length are produced with the halogen-free **PUR** cable type and are available from stock.

Ordering data for products with variable cable:

For a 4.5 m long sensor/actuator cable, PUR, halogen-free, black, with a straight 4-pos. M12 Y-connector and two straight M12 females, the ordering data is as follows:

Order No.	Cable type	Length [m] 40 m, maximum
1699766	PUR	4.5
Minimum order amount: 25 pcs.		Increments: 0.2 ... 3 m = 0.1 m > 3 m = 0.5 m

Cable description	Cable type	Suitable for:
PUR, halogen-free – black E221474	PUR	M8/M12
PUR, halogen-free – gray E221474	280	M12
TPE-U highly flexible – gray E221474	800	M8/M12
PUR irradiated – orange E221474	150	M12
PVC – black E221474	PVC	M8/M12
PVC – gray E221474	500	M8/M12
PVC – yellow E221474	540	M12
PVC 105° – yellow E221474	542	M12

Color coding	Pin assignment, 3-pos.	
	Male	Female
BN	1	1
BK	2 + 4	4
BU	3	3

With a combination of M12 and M8 connectors, the limiting M8 value applies to the rated voltage.

	Technical data	Technical data	Technical data	Technical data
	Y-M8	Y-M8 with LEDs	Y-M12	Y-M12 with LEDs
Rated voltage	48 V AC / 60 V DC	24 V / 24 V DC	250 V AC / 250 V DC	24 V / 24 V DC
Rated current [A]	4	4	4	4
Contact material	CuSn	CuSn	CuSn	CuSn
Contact surface material	Ni/Au	Ni/Au	Ni/Au	Ni/Au
Material of grip body	TPU, hardly inflammable, self-extinguishing	TPU, hardly inflammable, self-extinguishing	TPU, hardly inflammable, self-extinguishing	TPU, hardly inflammable, self-extinguishing
M8 circular connector in accordance with:	IEC 61076-2-104	IEC 61076-2-104	-	-
M12 circular connector in accordance with:	IEC 61076-2-101	IEC 61076-2-101	IEC 61076-2-101	IEC 61076-2-101
Degree of protection	IP65 / IP67 / IP68	IP65 / IP67 / IP68	IP65 / IP67 / IP68	IP65 / IP67 / IP68
Temperature data				
Male connector/female connector [°C]	-25 ... 90	-25 ... 90	-25 ... 90	-25 ... 90

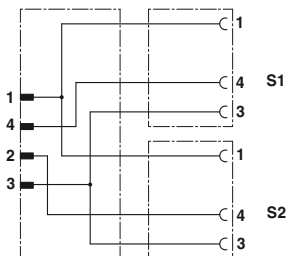

Contact assignment of the M12 male and the M8/M12 female connectors

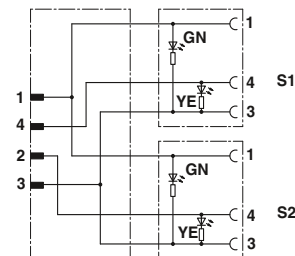

Contact assignment of the M12 male and the M8 female connectors, with LEDs

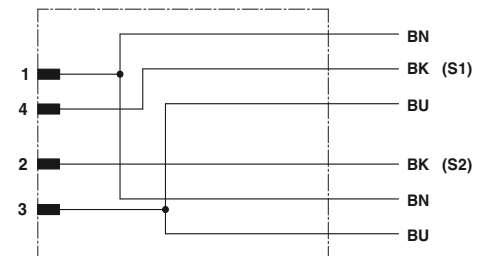

Contact assignment of the M12 Y connector

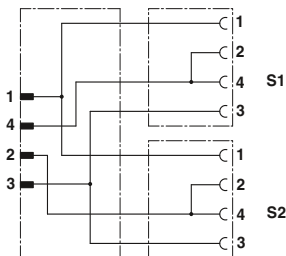

Contact assignment of the M12 male and the M12 female connector, bridged

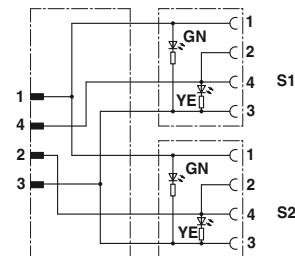

Contact assignment of the M12 male and the M12 female connectors, with LEDs, bridged

Sensor/actuator cabling

Distributors and adapters

M8 and M12 Y distributors, M12 T distributors



3-pos.



3+PE-pos.

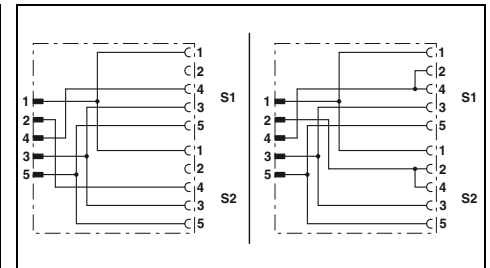
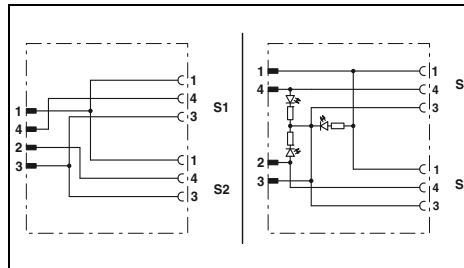

Technical data

General data	
M8 circular connector in accordance with:	
M12 circular connector in accordance with:	
Degree of pollution	
Degree of protection	
Electrical data	
Rated voltage	
Rated current	
Material data	
Contact material	
Contact surface material	
Flammability rating in accordance with UL 94	
Temperature data	
Male connector/female connector	[°C]

Without LED	With 3 LEDs
IEC 61076-2-104	-
	IEC 61076-2-101
	3
	IP65 / IP67
48 V AC / 60 V DC	24 V DC
	4 A
	CuZn
	Ni/Au
	HB
	-25 ... 90

Technical data

Not bridged	Pins 2 and 4 bridged
	-
	IEC 61076-2-101
	3
	IP65 / IP67
48 V AC / 60 V DC	48 V AC / 60 V DC
	4 A
	CuZn
	Ni/Au
	HB
	-25 ... 90

Ordering data

Description	Center distance
M8/M12 Y-distributor	
M8 male to 2x M8 female	12 mm
M12 male to 2x M8 female	12 mm
M12 Y-distributor	
M12 male to 2x M12 female	18 mm
M12 male to 2x M12 female	21 mm
M12 Y-distributor	
M12 male to 2x M12 female	21 mm
T-distributor	
M12 male to 2x M12 female	

Order No.	Pcs./Pkt.	Order No.	Pcs./Pkt.
Without LED		With 3 LEDs	

Ordering data

Order No.	Pcs./Pkt.	Order No.	Pcs./Pkt.
Not bridged		Pins 2 and 4 bridged	

M8/M12 adapters



3-, 4-pos.

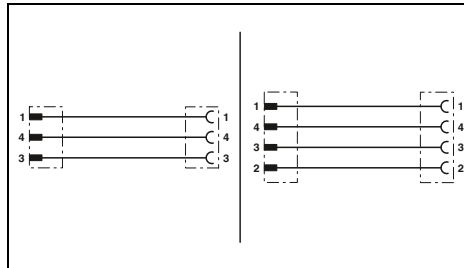

Technical data

	3-pos.	4-pos.
General data		
M8 circular connector in accordance with:	IEC 61076-2-104	
M12 circular connector in accordance with:	IEC 61076-2-101	
Degree of pollution	3	
Degree of protection	IP65 / IP67	
Electrical data		
Rated voltage	48 V AC / 60 V DC	30 V AC / 30 V DC
Rated current	4 A	
Material data		
Contact material	CuSn	
Contact surface material	Ni/Au	
Flammability rating in accordance with UL 94	HB	
Temperature data		
Male connector/female connector [°C]	-25 ... 90	

Ordering data

Description	Order No.	Pcs./Pkt.	Order No.	Pcs./Pkt.
	3-pos.		4-pos.	
Adapter				
M8 male to M12 female	1519749	5	1519736	5
M12 male to M8 female	1519752	5	1519765	5
M12 male to M8 snap-in female	1519781	5	1519778	5

Valve connector adapters with M12 male connector



Valve connector type A



Valve connector, AD design, pressure switch

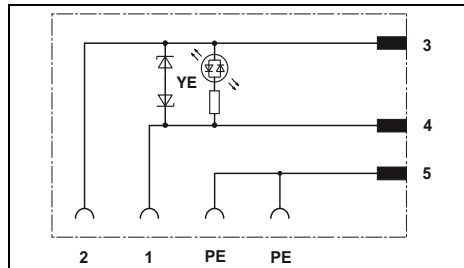

Technical data

General data	
M12 circular connector in accordance with:	IEC 61076-2-101
Valve connector in accordance with:	EN 175301-803
Degree of pollution	3
Degree of protection	IP65 / IP67
Electrical data in acc. with IEC 61076-2-101	
Rated voltage	24 V AC / 24 V DC
Rated current	4 A
Status display	Yellow LED
Material data	
Material contact M12	CuSn
Material contact valve connector	CuSn
Material contact surface M12	Ni/Au
Material contact surface valve connector	Sn
Flammability rating in accordance with UL 94	HB
Temperature data	
Valve connectors	-25 ... 85 [°C]

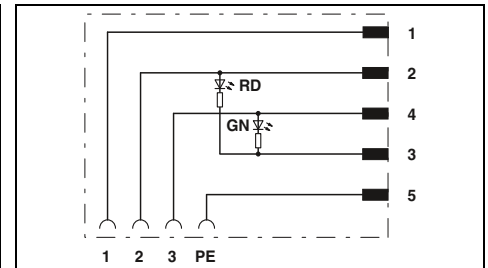

Technical data

General data	
M12 circular connector in accordance with:	IEC 61076-2-101
Valve connector in accordance with:	EN 175301-803
Degree of pollution	3
Degree of protection	IP65 / IP67
Electrical data in acc. with IEC 61076-2-101	
Rated voltage	24 V AC / 24 V DC
Rated current	4 A
Status display	2 LEDs
Material data	
Material contact M12	CuSn
Material contact valve connector	CuSn
Material contact surface M12	Ni/Au
Material contact surface valve connector	Sn
Flammability rating in accordance with UL 94	HB
Temperature data	
Valve connectors	-25 ... 85 [°C]

Ordering data

Description	Type	Order No.	Pcs./Pkt.
Valve connector type A , PE bridged, 18 mm contact spacing			
- Vertical M12 male connector	SAC-3P-MS/A-1L-Z SCO	1458525	1
- Horizontal M12 male connector	SAC-3P-MR/A-1L-Z SCO	1458538	1
Valve connector type AD , 18 mm contact spacing			
- Vertical M12 male connector			
- Horizontal M12 male connector			
Valve connector type B , 10 mm contact spacing			
- Vertical M12 male connector			
- Horizontal M12 male connector			
Valve connector type BI , 11 mm contact spacing			
- Vertical M12 male connector			
- Horizontal M12 male connector			
DESINA valve connector type A , 18 mm contact spacing			
- Vertical M12 male connector			

Ordering data

Description	Type	Order No.	Pcs./Pkt.
Valve connector type AD , 18 mm contact spacing			
- Vertical M12 male connector	SAC-5P-MS/AD-2L SCO	1458596	1
- Horizontal M12 male connector	SAC-5P-MR/AD-2L SCO	1458606	1



Valve connector type B



Valve connector type BI



DESINA valve connector type A

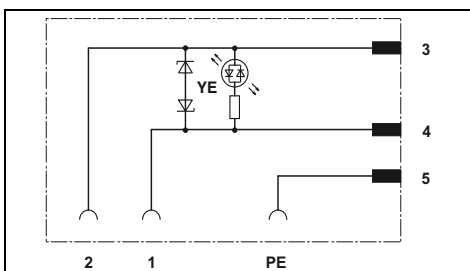

Technical data

IEC 61076-2-101
EN 175301-803
3
IP65 / IP67

24 V AC / 24 V DC
4 A
Yellow LED

CuSn
CuSn
Ni/Au
Sn
HB

-25 ... 85

Ordering data

Type	Order No.	Pcs./Pkt.
SAC-3P-MS/B-1L-Z SCO	1458541	1
SAC-3P-MR/B-1L-Z SCO	1458544	1

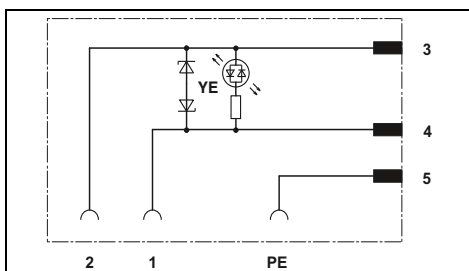

Technical data

IEC 61076-2-101
-
3
IP65 / IP67

24 V AC / 24 V DC
4 A
Yellow LED

CuSn
CuSn
Ni/Au
Sn
HB

-25 ... 85

Ordering data

Type	Order No.	Pcs./Pkt.
SAC-3P-MS/BI-1L-Z SCO	1458567	1
SAC-3P-MR/BI-1L-Z SCO	1458570	1

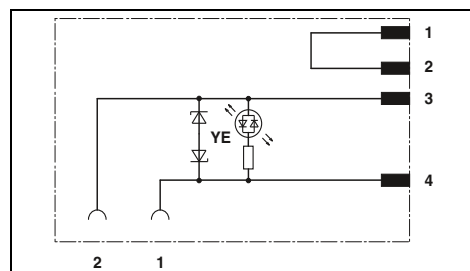

Technical data

IEC 61076-2-101
EN 175301-803
3
IP65 / IP67

24 V AC / 24 V DC
4 A
Yellow LED

CuSn
CuSn
Ni/Au
Sn
HB

-25 ... 85

Ordering data

Type	Order No.	Pcs./Pkt.
SAC-4P-MS/A-1L-Z D SCO	1458583	1

Sensor/actuator cabling

Distributors and adapters

Double valve connector adapters with M12 male connector, type A



Type A

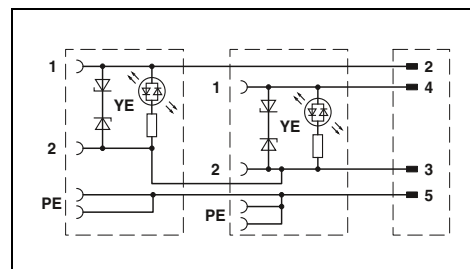

Technical data

General data	
M12 circular connector in accordance with:	IEC 61076-2-101
Valve connector in accordance with:	EN 175301-803
Degree of protection	IP65 / IP67
Electrical data	
Rated voltage	24 V AC / 24 V DC
Rated current	4 A
Material data	
Material contact M12	CuSn
Material contact valve connector	CuSn
Material contact surface M12	Ni/Au
Material contact surface valve connector	Sn
Material housing valve connector	TPU
Temperature data	
Valve connectors	-25 ... 85 [°C]

Ordering data

Description	Type	Order No.	Pcs./Pkt.
Double valve connector , plug distance: 10 cm, valve connector leading to valve connector adapter with:			
- Vertical M12 male connector	SAC-MS/0,1-116/2XA-1L-Z SCO	1458101	1
- Horizontal M12 male connector	SAC-MR/0,1-116/2XA-1L-Z SCO	1458130	1
Double valve connector , plug distance: 15 cm, valve connector leading to valve connector adapter with:			
- Vertical M12 male connector	SAC-MS/0,15-116/2XA-1L-Z SCO	1458114	1
- Horizontal M12 male connector	SAC-MR/0,15-116/2XA-1L-Z SCO	1458143	1
Double valve connector , plug distance: 20 cm, valve connector leading to valve connector adapter with:			
- Vertical M12 male connector	SAC-MS/0,2-116/2XA-1L-Z SCO	1458127	1
- Horizontal M12 male connector	SAC-MR/0,2-116/2XA-1L-Z SCO	1458156	1

Double valve connector adapters with M12 male, type B and BI



Type B



Type BI

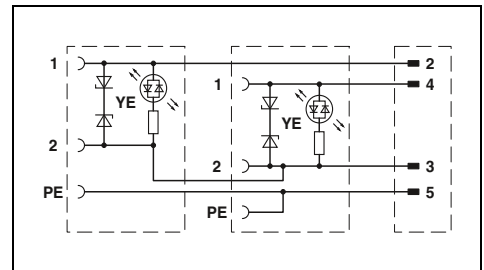
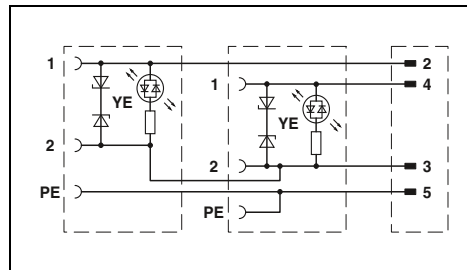

Technical data

Technical data

General data	
M12 circular connector in accordance with:	IEC 61076-2-101
Valve connector in accordance with:	EN 175301-803
Degree of protection	IP65 / IP67
Electrical data	
Rated voltage	24 V AC / 24 V DC
Rated current	4 A
Material data	
Material contact M12	CuSn
Material contact valve connector	CuSn
Material contact surface M12	Ni/Au
Material contact surface valve connector	Sn
Material housing valve connector	TPU
Temperature data	
Valve connectors	-25 ... 85 [°C]

General data	
M12 circular connector in accordance with:	IEC 61076-2-101
Valve connector in accordance with:	-
Degree of protection	IP65 / IP67
Electrical data	
Rated voltage	24 V AC / 24 V DC
Rated current	4 A
Material data	
Material contact M12	CuSn
Material contact valve connector	CuSn
Material contact surface M12	Ni/Au
Material contact surface valve connector	Sn
Material housing valve connector	TPU
Temperature data	
Valve connectors	-25 ... 85

Ordering data

Ordering data

Description
Double valve connector , plug distance: 10 cm, valve connector leading to valve connector adapter with: - Vertical M12 male connector - Horizontal M12 male connector
Double valve connector , plug distance: 15 cm, valve connector leading to valve connector adapter with: - Vertical M12 male connector - Horizontal M12 male connector
Double valve connector , plug distance: 20 cm, valve connector leading to valve connector adapter with: - Vertical M12 male connector - Horizontal M12 male connector

Type	Order No.	Pcs./Pkt.
SAC-MS/0,1-116/2XB-1L-Z SCO	1458282	1
SAC-MR/0,1-116/2XB-1L-Z SCO	1458318	1
SAC-MS/0,15-116/2XB-1L-Z SCO	1458295	1
SAC-MR/0,15-116/2XB-1L-Z SCO	1458321	1
SAC-MS/0,2-116/2XB-1L-Z SCO	1458305	1
SAC-MR/0,2-116/2XB-1L-Z SCO	1458334	1

Type	Order No.	Pcs./Pkt.
SAC-MS/0,1-116/2XBI-1L-Z SCO	1458460	1
SAC-MR/0,1-116/2XBI-1L-Z SCO	1458499	1
SAC-MS/0,15-116/2XBI-1L-Z SCO	1458473	1
SAC-MR/0,15-116/2XBI-1L-Z SCO	1458509	1
SAC-MS/0,2-116/2XBI-1L-Z SCO	1458486	1
SAC-MR/0,2-116/2XBI-1L-Z SCO	1458512	1

Distributor boxes

M8 distributors with metal thread



With a master cable



M12 male-in connection, vertical



M12 male-in connection, vertical

General data

Degree of protection in acc. with IEC 60529/EN 60529
M8 circular connector in accordance with:
M12 circular connector in accordance with:

Electrical data

Rated current for each I/O signal	[A]	2
Rated current per slot	[A]	2
Rated current, total	[A]	6

Dimensions

Width x height	[mm]	30 x 22
(Length (4 / 6 / 8 / 10 slots))	[mm]	102 / 122 / 141 / 161

Temperature data

Distributor box	[°C]	-30 ... 80
Master cable, fixed installation	[°C]	-
Master cable, flexible installation	[°C]	-

Status indication	Signal type	Rated voltage	Slots	Cable length
With LED	PNP	24 V DC	4	-
With LED	PNP	24 V DC	4	5 m
With LED	PNP	24 V DC	4	10 m
With LED	PNP	24 V DC	6	-
With LED	PNP	24 V DC	6	5 m
With LED	PNP	24 V DC	6	10 m
With LED	PNP	24 V DC	8	-
With LED	PNP	24 V DC	8	5 m
With LED	PNP	24 V DC	8	10 m
With LED	PNP	24 V DC	10	-
With LED	PNP	24 V DC	10	5 m
With LED	PNP	24 V DC	10	10 m

For accessories, see page
For master cable coils, see page
For master cable data, see page

Technical data		Technical data		Technical data	
IP65 / IP67 IEC 61076-2-104 -		IP65 / IP67 IEC 61076-2-104 IEC 61076-2-101		IP65 / IP67 IEC 61076-2-104 IEC 61076-2-101	
2 2 6		2 2 4		1.5 1.5 1.5	
30 x 22 102 / 122 / 141 / 161		30 x 27 93 / 113 / - / -		30 x 27 - / - / 133 / 152	
-30 ... 80 - -		-30 ... 80 - -		-30 ... 80 - -	
Ordering data		Ordering data		Ordering data	
Single occupancy	Double occupancy	Single occupancy	Double occupancy	Single occupancy	Double occupancy
-	-	1516234	-	-	-
1516014	-	-	-	-	-
1516027	-	-	-	-	-
-	-	1516247	-	-	-
1516030	-	-	-	-	-
1516043	-	-	-	-	-
-	-	-	-	1434840	-
1516056	1516111	-	-	-	-
1516069	1516124	-	-	-	-
-	-	-	-	1434853	-
1516072	-	-	-	-	-
1516085	-	-	-	-	-
Notes:		Notes:		Notes:	
311		311		311	
330		305		305	

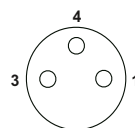

Pin assignment M8 female, 3-pos.

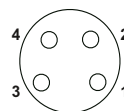

Pin assignment M8 female, 4-pos.

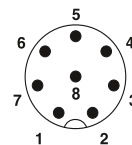

Connector pin assignment for M12 male-in connection, 8-pos.

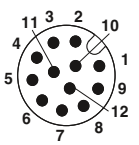

Pin assignment for M12 male-in connection, 12-pos.



M16 plug-in connection, vertical



Spring connection, horizontal



Plug-in screw connection, horizontal



Header for plug-in screw connection



Connector hood, with a master cable



Connector hood, without master cable

Technical data		Technical data		Technical data		Technical data		Technical data		Technical data	
IP65 / IP67 IEC 61076-2-104		IP65 / IP67 IEC 61076-2-104		IP65 / IP67 IEC 61076-2-104		IP65 / IP67 IEC 61076-2-104		IP65 / IP67		IP65 / IP67	
-		-		-		-		-		-	
2		2		2		2		2		2	
2		2		2		2		2		2	
6		6		8		8		8		-	
30 x 26 93 / 113 / 132 / 152		30 x 44 122 / 142 / 176 / 196		30 x 44 122 / 142 / 176 / 196		30 x 20 122 / 142 / 176 / 196		30 x 24 60 / 60 / 74 / 74		30 x 24 - / - / - / -	
-30 ... 80		-30 ... 80		-30 ... 80		-30 ... 80		-30 ... 80 -40 ... 90 -5 ... 80		-30 ... 80	
-		-		-		-		-		-	
Ordering data		Ordering data		Ordering data		Ordering data		Ordering data		Ordering data	
Single occupancy	Double occupancy	Single occupancy	Double occupancy	Single occupancy	Double occupancy	Single occupancy	Double occupancy	Single occupancy	Double occupancy	Single occupancy	Double occupancy
1516182	-	1503386	-	1503412	-	1516250	-	-	-	1521229	-
-	-	-	-	-	-	-	-	1516292	-	-	-
-	-	-	-	-	-	-	-	1516302	-	-	-
1516195	-	1503399	-	1503425	-	1516263	-	-	-	1521216	-
-	-	-	-	-	-	-	-	1516315	-	-	-
-	-	-	-	-	-	-	-	1516328	-	-	-
1516205	-	1511747	1503454	1511750	1503467	1516276	-	-	-	1516425	-
-	-	-	-	-	-	-	-	1516331	-	-	-
-	-	-	-	-	-	-	-	1516344	-	-	-
1516218	-	1503409	-	1503438	-	1516289	-	-	-	1516412	-
-	-	-	-	-	-	-	-	1516357	-	-	-
-	-	-	-	-	-	-	-	1516360	-	-	-
Notes:		Notes:		Notes:		Notes:		Notes:		Notes:	
310 305		310 305		310 305		310		310 330			

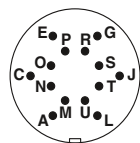

Connector pin assignment for M16 plug-in connection, 14-pos.

Sensor/actuator cabling

Distributor boxes

M12 distributors with plastic thread, middle duty



With a master cable



Spring connection, horizontal



Push-in spring connection, horizontal

General data	
Degree of protection in acc. with IEC 60529/EN 60529	
M12 circular connector in accordance with:	
Electrical data	
Rated current for each I/O signal	[A]
Rated current per slot	[A]
Rated current, total	[A]
Dimensions	
Width x height	[mm]
(Length (4 / 6 / 8 / 10 slots))	[mm]
Temperature data	
Distributor box	[°C]
Master cable, fixed installation	[°C]
Master cable, flexible installation	[°C]

Technical data		Technical data		Technical data	
IP65 / IP67		IP65 / IP67		IP65 / IP67	
IEC 61076-2-101		IEC 61076-2-101		IEC 61076-2-101	
2	4	2	4	2	4
12	-	12	-	-	-
54 x 23	117 / 123 / 149 / -	54 x 42	117 / 123 / 149 / -	54 x 43	117 / 123 / 149 / -
-25 ... 80	-40 ... 90	-25 ... 80	-	-25 ... 80	-
-	-5 ... 80	-	-	-	-

Status indication	Signal type	Rated voltage	Slots	Cable length
Without LED	Universal	120 V	4	-
Without LED	Universal	120 V	4	5 m
Without LED	Universal	120 V	6	-
Without LED	Universal	120 V	6	5 m
Without LED	Universal	120 V	6	10 m
Without LED	Universal	120 V	8	-
Without LED	Universal	120 V	8	5 m
Without LED	Universal	120 V	8	10 m
With LED	PNP	24 V DC	4	-
With LED	PNP	24 V DC	4	1.5 m
With LED	PNP	24 V DC	4	5 m
With LED	PNP	24 V DC	4	10 m
With LED	PNP	24 V DC	4	15 m
With LED	PNP	24 V DC	4	20 m
With LED	PNP	24 V DC	6	-
With LED	PNP	24 V DC	6	5 m
With LED	PNP	24 V DC	6	10 m
With LED	PNP	24 V DC	8	-
With LED	PNP	24 V DC	8	1.5 m
With LED	PNP	24 V DC	8	3 m
With LED	PNP	24 V DC	8	5 m
With LED	PNP	24 V DC	8	10 m
With LED	PNP	24 V DC	8	15 m
With LED	PNP	24 V DC	8	20 m
-	-	120 V	8	25 m
-	-	120 V	8	30 m
-	-	120 V	8	50 m
With LED	NPN	24 V DC	8	5 m
With LED	NPN	24 V DC	8	10 m

Ordering data		Ordering data		Ordering data	
Single occupancy	Double occupancy	Single occupancy	Double occupancy	Single occupancy	Double occupancy
-	-	1452929	1452932	-	-
1452398	1452424	-	-	-	-
-	-	1452945	1452958	-	-
-	1452482	-	-	-	-
1452466	1452495	-	-	-	-
-	-	-	1452974	-	-
1452518	1452547	-	-	-	-
1452521	1452550	-	-	-	-
-	-	1452987	1452990	-	1412058
-	1097569	-	-	-	-
1452576	1452602	-	-	-	-
1452589	1452615	-	-	-	-
-	1097602	-	-	-	-
-	1027009	-	-	-	-
-	-	1453009	1453012	-	1412059
1452631	1452660	-	-	-	-
1452644	1452673	-	-	-	-
-	-	1453025	1453038	-	1412060
-	1097612	-	-	-	-
-	1097629	-	-	-	-
1452699	1452725	-	-	-	-
1452709	1452738	-	-	-	-
-	1097635	-	-	-	-
-	1027000	-	-	-	-
-	-	-	-	-	-
-	-	-	-	-	-
-	-	-	-	-	-
1405737	1405739	-	-	-	-
1405738	1405740	-	-	-	-

For accessories, see page
 For master cable coils, see page
 For master cable data, see page

Notes:	Notes:	Notes:
312	312	312
331	305	305

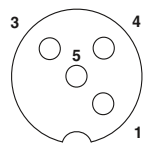

Pin assignment of M12 female, 4-pos.

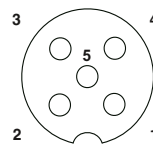

Pin assignment of M12 female, 5-pos.



Plug-in screw connection, horizontal







Header for plug-in screw connection



Connector hood, with master cable, with plug-in screw connection



Connector hood, without master cable, with plug-in screw connection

							
Technical data		Technical data		Technical data		Technical data	
IP65 / IP67 IEC 61076-2-101		IP65 / IP67 IEC 61076-2-101		IP65 / IP67 -		IP65 / IP67 -	
2	4	2	4	2	4	2	4
10		10		10		-	
54 x 43 117 / 123 / 149 / -		54 x 19 117 / 123 / 149 / -		54 x 25 34 / 34 / 34 / -		54 x 25 34 / 34 / 34 / -	
-25 ... 80		-25 ... 80		-25 ... 80 -40 ... 90 -5 ... 80		-25 ... 80	
Ordering data		Ordering data		Ordering data		Ordering data	
Single occupancy	Double occupancy	Single occupancy	Double occupancy	Single occupancy	Double occupancy	Single occupancy	Double occupancy
1452741	1452754	-	-	-	-	-	-
-	-	-	-	-	-	-	-
1452767	1452770	-	-	-	-	-	-
-	-	-	-	-	-	-	-
-	-	-	-	-	-	-	-
1452783	1452796	-	-	-	-	-	-
-	-	-	-	-	-	-	-
-	-	-	-	-	-	-	-
1452806	1452819	1452864	1452877	-	-	1453229	1453229
-	-	-	-	-	-	-	-
-	-	-	-	-	1453083	-	-
-	-	-	-	-	1453096	-	-
-	-	-	-	-	1422784	-	-
-	-	-	-	-	-	-	-
1452822	1452835	1452880	1452893	-	-	1453229	1453229
-	-	-	-	-	1453148	-	-
-	-	-	-	1453122	-	-	-
1452848	1452851	1452903	1452916	-	-	1453229	1453229
-	-	-	-	-	-	-	-
-	-	-	-	-	-	-	-
-	-	-	-	1453177	1453203	-	-
-	-	-	-	1453180	1453216	-	-
-	-	-	-	-	1422787	-	-
-	-	-	-	-	1097653	-	-
-	-	-	-	-	1097661	-	-
-	-	-	-	-	1097665	-	-
-	-	-	-	-	1097669	-	-
-	-	-	-	-	-	-	-
-	-	-	-	-	-	-	-
Notes:		Notes:		Notes:		Notes:	
312	305	312		312		312	
				331			

Distributor boxes

M12 distributors with metal thread, heavy-duty



With a master cable



With halogen-free master line



Plug-in screw connection, horizontal

General data	
Degree of protection in acc. with IEC 60529/EN 60529	
M12 circular connector in accordance with:	
Electrical data	
Rated current for each I/O signal	[A]
Rated current per slot	[A]
Rated current, total	[A]
Total rated current for electrical isolation	[A]
Dimensions	
Width x height	[mm]
(Length (4 / 6 / 8 / 10 slots))	[mm]
Temperature data	
Distributor box	[°C]
Master cable, fixed installation	[°C]
Master cable, flexible installation	[°C]

Technical data		Technical data		Technical data	
IP65 / IP67 / IP69K IEC 61076-2-101		IP65 / IP67 / IP69K IEC 61076-2-101		IP65 / IP67 / IP69K IEC 61076-2-101	
2	4	2	4	2	4
12	-	12	-	10	2x 8
58 x 26	117 / 126 / 153 / -	58 x 26	116 / 126 / 153 / -	58 x 45	117 / 126 / 153 / -
-30 ... 90	-40 ... 90	-30 ... 90	-40 ... 90	-30 ... 80	-
-5 ... 80	-5 ... 80	-5 ... 80	-	-	-

Status indication	Signal type	Rated voltage	Slots	Cable length
Without LED	Universal	120 V	4	-
Without LED	Universal	120 V	4	5 m
Without LED	Universal	120 V	4	10 m
Without LED	Universal	120 V	6	-
Without LED	Universal	120 V	6	5 m
Without LED	Universal	120 V	6	10 m
Without LED	Universal	120 V	8	-
Without LED	Universal	120 V	8	5 m
Without LED	Universal	120 V	8	10 m
With LED	PNP	24 V DC	4	-
With LED	PNP	24 V DC	4	5 m
With LED	PNP	24 V DC	4	10 m
With LED	PNP	24 V DC	6	-
With LED	PNP	24 V DC	6	5 m
With LED	PNP	24 V DC	6	10 m
With LED	PNP	24 V DC	8	-
With LED	PNP	24 V DC	8	1.5 m
With LED	PNP	24 V DC	8	5 m
With LED	PNP	24 V DC	8	10 m
With LED	NPN	24 V DC	4	-
With LED	NPN	24 V DC	6	-
With LED	NPN	24 V DC	8	-

Ordering data		Ordering data		Ordering data	
Single occupancy	Double occupancy	Single occupancy	Double occupancy	Single occupancy	Double occupancy
-	-	-	-	1516849	1516852
1516962	1516988	-	1517204	-	-
1516975	1516991	-	1517217	-	-
-	-	-	-	1516865	1516878
1517000	1517026	-	1517220	-	-
1517013	1517039	-	1517233	-	-
-	-	-	-	1516881	1516894
1517042	1517068	-	1517246	-	-
1517055	1517071	-	1517259	-	-
-	-	-	-	1516784	1516797
1517084	1517107	-	1517262	-	-
1517097	1517110	-	1517275	-	-
-	-	-	-	1516807	1516810
1517123	1517149	-	1517288	-	-
1517136	1517152	-	1517291	-	-
-	-	-	-	1516823	1516836
-	-	-	-	-	-
1517165	1517181	-	1517301	-	-
1517178	1517194	-	1517314	-	-
-	-	-	-	1537077	1537103
-	-	-	-	1537080	1537116
-	-	-	-	1537093	1537129

For accessories, see page
 For master cable coils, see page
 For master cable data, see page

Notes:	Notes:	Notes:
313	313	313
331	333	305

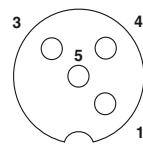

Pin assignment of M12 female, 4-pos.

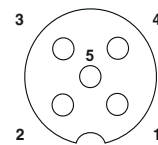

Pin assignment of M12 female, 5-pos.



Header for plug-in screw connection



Connector hood, with a master cable



Connector hood, without master cable



With master cable connection, rear



Plug-in spring connection, back



With FLK pin strip, rear

ERAC		ERAC		ERAC		ERAC		ERAC		ERAC	
Technical data		Technical data		Technical data		Technical data		Technical data		Technical data	
IP65 / IP67 / IP69K IEC 61076-2-101		IP65 / IP67 / IP69K -		IP65 / IP67 / IP69K -		IP54 IEC 61076-2-101		IP54 IEC 61076-2-101		IP54 IEC 61076-2-101	
2	4	2	4	2	4	2	4	2	4	0.5	0.5
10	2x 8	10	-	-	-	12	-	8	-	4	8
58 x 26	117 / 126 / 153 / -	58 x 21	34 / 34 / 34 / -	58 x 21	- / - / - / -	58 x 28	- / - / 159 / -	58 x 28	- / - / 159 / -	58 x 28	- / - / 159 / -
-30 ... 80	-	-30 ... 80	-40 ... 90	-5 ... 80	-	-30 ... 80	-	-30 ... 80	-	-30 ... 80	-
Ordering data		Ordering data		Ordering data		Ordering data		Ordering data		Ordering data	
Single occupancy	Double occupancy	Single occupancy	Double occupancy	Single occupancy	Double occupancy	Single occupancy	Double occupancy	Single occupancy	Double occupancy	Single occupancy	Double occupancy
-	-	-	-	-	-	-	-	-	-	-	-
-	-	-	-	-	-	-	-	-	-	-	-
-	-	-	-	-	-	-	-	-	-	-	-
1516726	1516739	-	-	1516713	1516713	-	-	-	-	-	-
-	-	1516353	1516593	-	-	-	-	-	-	-	-
-	-	1516548	1516603	-	-	-	-	-	-	-	-
1516742	1516755	-	-	1516713	1516713	-	-	-	-	-	-
-	-	1516551	1516616	-	-	-	-	-	-	-	-
-	-	1516564	1516629	-	-	-	-	-	-	-	-
1516768	1516771	-	-	1516713	1516713	-	-	-	1437232	1547928	-
-	-	1516577	1516632	-	-	1437245	-	-	-	-	-
-	-	1516580	1516645	-	-	-	-	-	-	-	-
-	-	-	-	-	-	-	-	-	-	-	-
-	-	-	-	-	-	-	-	-	-	-	-
-	-	-	-	-	-	-	-	-	-	-	-
Notes:	Notes:	Notes:	Notes:	Notes:	Notes:	Notes:	Notes:	Notes:	Notes:	Notes:	Notes:
313	313	313	313	313	313	313	313	313	313	313	313
	331							331			

Sensor/actuator cabling

Distributor boxes

QUICKON distributors,
connection cross section:
0.14 mm² ... 0.34 mm²



With a master cable



Plug-in screw connection,
horizontal

General data	
Degree of protection in acc. with IEC 60529/EN 60529	
Electrical data	
Rated current for each I/O signal	[A]
Rated current per slot	[A]
Rated current, total	[A]
Total rated current for electrical isolation	[A]
Dimensions	
Width x height	[mm]
(Length (4 / 6 / 8 / 10 slots))	[mm]
Temperature data	
Distributor box	[°C]
Master cable, fixed installation	[°C]
Master cable, flexible installation	[°C]

.FA US EAC		.FA US EAC	
Technical data		Technical data	
IP65 / IP67 / IP69K		IP65 / IP67 / IP69K	
2	2	4	4
4	4	10	10
12	10	2x 8	2x 8
-	2x 8	-	-
58 x 45	58 x 45	58 x 45	58 x 45
116 / - / 153 / -	117 / 126 / 153 / -	117 / 126 / 153 / -	117 / 126 / 153 / -
-30 ... 80	-30 ... 80	-30 ... 80	-30 ... 80
-40 ... 90	-	-	-
-5 ... 80	-	-	-

Status indication	Signal type	Rated voltage	Slots	Cable length
Without LED	Universal	48 V	4	-
Without LED	Universal	48 V	6	-
Without LED	Universal	48 V	8	-
With LED	PNP	24 V DC	4	-
With LED	PNP	24 V DC	4	5 m
With LED	PNP	24 V DC	4	10 m
With LED	PNP	24 V DC	6	-
With LED	PNP	24 V DC	8	-
With LED	PNP	24 V DC	8	5 m
With LED	PNP	24 V DC	8	10 m

Ordering data		Ordering data	
Single occupancy	Double occupancy	Single occupancy	Double occupancy
-	-	1548354	1548419
-	-	1548367	1548422
-	-	1548370	1548435
-	-	1548325	1548383
1548448	1548532	-	-
1548451	1548545	-	-
-	-	1548338	1548396
-	-	1548341	1548406
1548480	1548574	-	-
1548493	1548587	-	-

For accessories, see page
 For master cable coils, see page
 For master cable data, see page

Notes:	Notes:
315	315
330	305

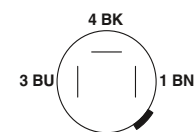

Pin assignment for
QUICKON connection, 3-pos.

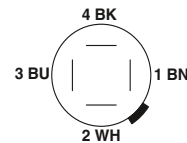

Pin assignment for
QUICKON connection, 4-pos.

**QUICKON distributors,
connection cross section:
0.34 mm² ... 0.75 mm²**



With a master cable



Spring connection,
horizontal

General data	
Degree of protection in acc. with IEC 60529/EN 60529	
Electrical data	
Rated current for each I/O signal	[A]
Rated current per slot	[A]
Rated current, total	[A]
Dimensions	
Width x height	[mm]
(Length (4 / 6 / 8 / 10 slots)	[mm]
Temperature data	
Distributor box	[°C]
Master cable, fixed installation	[°C]
Master cable, flexible installation	[°C]

Phoenix Contact		Phoenix Contact	
Technical data		Technical data	
IP65 / IP67		IP65 / IP67	
4	4	4	4
4	4	4	4
12	12	12	12
60 x 44		60 x 44	
97 / 134 / 170 / -		132 / 168 / 205 / -	
-25 ... 60		-25 ... 60	
-40 ... 90		-	
-5 ... 80		-	

Status indication	Signal type	Rated voltage	Slots	Cable length
Without LED	Universal	120 V	4	-
Without LED	Universal	120 V	4	5 m
Without LED	Universal	120 V	4	10 m
Without LED	Universal	120 V	6	-
Without LED	Universal	120 V	6	5 m
Without LED	Universal	120 V	6	10 m
Without LED	Universal	120 V	8	-
Without LED	Universal	120 V	8	5 m
Without LED	Universal	120 V	8	10 m
With LED	PNP	24 V DC	4	-
With LED	PNP	24 V DC	4	5 m
With LED	PNP	24 V DC	4	10 m
With LED	PNP	24 V DC	6	-
With LED	PNP	24 V DC	6	5 m
With LED	PNP	24 V DC	6	10 m
With LED	PNP	24 V DC	8	-
With LED	PNP	24 V DC	8	5 m
With LED	PNP	24 V DC	8	10 m
With LED	NPN	24 V DC	4	-
With LED	NPN	24 V DC	6	-
With LED	NPN	24 V DC	8	-

Phoenix Contact		Phoenix Contact	
Ordering data		Ordering data	
Single occupancy	Double occupancy	Single occupancy	Double occupancy
-	-	1683633	-
1683662	-	-	-
1683675	-	-	-
-	-	1683646	-
1683688	-	-	-
1683691	-	-	-
-	-	1683659	-
1683701	-	-	-
1683714	-	-	-
-	-	1662939	-
1695223	-	-	-
1695236	-	-	-
-	-	1662942	-
1695252	-	-	-
1695265	-	-	-
-	-	1662955	-
1695281	-	-	-
1695294	-	-	-
-	-	1680856	-
-	-	1680869	-
-	-	1680872	-

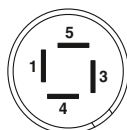

Pin assignment for
QUICKON connection, 4-pos.



Fast and secure connection

The M12 connectors snap into place quickly and securely with a single click thanks to the push-pull fast locking system. This offers significant advantages in particular in confined spaces or when the mating connector is difficult to see. The 360° shield connection and high vibration resistance also enable use in rail vehicles.



Connectors for assembly

With our M12 connectors for assembly, you can adapt the cabling flexibly to your requirements. In addition to connectors with convenient QUICKON (IDC) connection, we also offer versions with robust crimp and spring connection.



Assembled cables

The molded connectors in our M12 RAIL series provide a reliable cabling system for all control levels in the train. Choose your cabling from assembled sensor/actuator cables and data cables for communication networks and passenger information systems.



Flame-retardant

An important aspect in the selection of the plastics used in the railway industry is their flame retardancy. We satisfy stringent requirements regarding behavior in fire, thanks to our irradiated railway cables and PA 6.6 molding material.



Securely locked

The special vibration brake prevents the unintentional loosening of the plug-in connection in the event of vibrations.

The connectors are tested in accordance with EN 50155 for resistance to shock and vibrations.



Temperature-resistant

Particularly high or low temperatures and temperature shocks may not affect the electrical function of the components used either.

Our products are intensively tested for an extended temperature range and for resistance to temperature shocks.



Certified in accordance with IRIS

The Phoenix Contact Group is currently IRIS-certified. IRIS is an international rail industry standard for quality management systems.

Find out more with the web code

Detailed information on these products can be found on our website. Simply enter # followed by the numbers in the search field.





Resistance to cleaning agents

The connectors in a hygienic and washdown design are tested for resistance to cleaning agents commonly used in the food industry in accordance with Diversey and ECOLAB standards.



Product-contacting area

The components and devices used here must meet the highest hygienic requirements. Our cabling in a hygienic design is suitable for use in this area.



Splash zone

The products in a washdown design are suitable for the splash zone. Cost-effective features include resistance to cleaning agents and cleaning methods.



Connectors for the splash zone

For the special requirements of the food industry, we offer flush-type connectors and connectors with stainless steel components for assembly.



Assembled cables for all areas

Molded cables are available with connectors in sizes M8 and M12 in a hygienic or washdown design.



Distributor boxes for the splash zone

Distributor boxes with stainless steel housing and permanently connected PVC master cable in a washdown design are available for the splash zone.



Mechanical resistance

All components for the food industry are IP69K tested. This means guaranteed sealing for applications with steam jets, even after repeated temperature shocks.

Find out more with the web code

Detailed information on these products can be found on our website. Simply enter # followed by the numbers in the search field.





Adapted to the relevant requirements

Through the selection of special materials, the components are designed for use outdoors. The materials are resistant to UV, ozone, corrosion, and heat.



For a variety of applications

Outdoor components are particularly suitable for use in traffic management systems, snow cats and snow cannons, photovoltaic systems, and wind turbine generators.



UV and ozone testing

Testing with special climate cabinets ensures that the connectors and cables are suitable for the control of solar plants, for example, without any restrictions.



Connectors for assembly

The connector knurls are made from stainless steel and the plastics are resistant to atmospheric influences. The connectors are available with insulation displacement connection and screw connection.



Assembled cables

In addition to 3- to 8-pos. shielded and unshielded versions, PROFINET and Ethernet cables are also available for data applications.



Distributor boxes

Robust, fully molded sensor/actuator distributor boxes with 8 slots are available with fixed master cable or plug-in screw connection.



IP69K protection

For outdoor applications, a high IP protection class is essential because products are exposed to direct atmospheric influences.

Find out more with the web code

Detailed information on these products can be found on our website. Simply enter # followed by the numbers in the search field.



Sensor/actuator cabling

Cabling for robots and drag chains



High level of durability

With their special design, our cables provide a high level of durability under alternating bending stress, e.g., in drag chains.



High level of resistance to welding sparks

The robust TPE-U outer sheath of the highly flexible cables is resistant to welding sparks. The cables can therefore be used in resistance welding processes.



High level of durability under torsional stress

Our cables achieve a high level of durability – even with large angles of torsion and simultaneous bending stress.

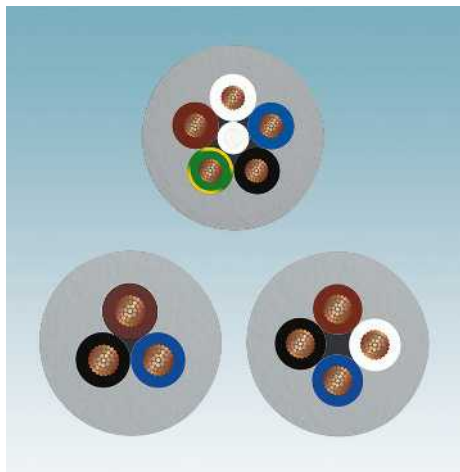

Large selection of number of positions

Our sensor/actuator cables for robots and drag chains are available in 3-, 4-, and 5-pos. versions.



Large selection of connectors

Sensor/actuator cables with molded plug-in plugs are available both as male and female connectors and with a straight or angled cable outlet.



Highly flexible master cables

For the distribution or grouping of signals at industrial robots, we offer a corresponding sensor/actuator box with special master cable.



100% tested

All supplied components are 100% electrically tested by Quality Assurance.

Find out more with the web code

Detailed information on these products can be found on our website. Simply enter # followed by the numbers in the search field.





Maximum power in a compact design

You can use the compact M12 POWER connectors to supply devices with up to 16 A or up to 630 V depending on the version. The M12 size therefore opens up new areas of application for supplying energy to your electrical devices.



DC application

The M12 POWER T and L DC codings are particularly suitable for the supply connection for decentral I/O modules and for DC motors.



AC application

The M12 POWER S, K, and M codings are designed for AC applications such as the power connection of a three-phase motor.



Connectors for assembly

The M12 connectors in straight and angled versions with crimp and screw connection are available for power transmission.



Safe transmission

With 360° shielded connectors and cables, you can transmit signals reliably even in critical EMI applications.



Power distributors

An M12 box with and without diagnostics function plus a Y-distributor with T-coding are available for power distribution.



100% tested

All supplied components are 100% electrically tested by Quality Assurance.

Find out more with the web code

Detailed information on these products can be found on our website. Simply enter # followed by the numbers in the search field.



Sensor/actuator cabling

M12 cabling for power applications

M12 POWER connectors, screw connection, crimp connection

Further power codings can be found on our website under web code:

i Your web code: #0024

new

new



T-coded, 4-pos.



L-coded, 4-pos., 4-pos.+FE



	Technical data			Technical data		
	4-pos., unshielded	4-pos., shielded		4-pos. + FE, shielded	4-pos., shielded	4-pos. + FE, shielded
General data						
Degree of pollution	3	3		3	3	3
Degree of protection	IP67	IP65		IP67	IP65	IP65
Connection method	Screw connection	Crimp connection		Screw connection	Crimp connection	Crimp connection
Connection cross section [mm ²]	0.75 mm ² ... 1.5 mm ²	1.5 mm ² ... 2.5 mm ²		1.5 mm ² ... 2.5 mm ²	1.5 mm ² ... 2.5 mm ²	1.5 mm ² ... 2.5 mm ²
Electrical data						
Rated voltage	63 V DC	63 V DC		63 V DC	63 V DC	63 V DC
Rated current	12 A (when using 1.5 mm ² conductors)	12 A (when using 1.5 mm ² conductors)		16 A (when using 2.5 mm ² conductors)	16 A (when using 2.5 mm ² conductors)	16 A (when using 2.5 mm ² conductors)
Insulation resistance	> 10 GΩ	≥ 100 MΩ		> 10 GΩ	≥ 100 MΩ	≥ 100 MΩ
Material data						
Material contact/contact surface	CuZn / Au	- / -		CuZn / Au	- / -	- / -
Contact carrier material	PA	PA		PA	PA	PA
Flammability rating in accordance with UL 94	V0	V0		V0	V0	V0
Temperature data						
Male connector/female connector [°C]	-40 ... 85	-40 ... 85		-40 ... 85	-40 ... 85	-40 ... 85
	Ordering data			Ordering data		
Description	Order No.	Pcs./Pkt.	Order No.	Pcs./Pkt.	Order No.	Pcs./Pkt.
	4-pos., unshielded		4-pos., shielded		4-pos. + FE, shielded	
Connector, cable diameter: 8 mm ... 10 mm						
Female, straight	1404644	1				
Male, straight	1404643	1				
Female, angled	1408989	1				
Male, angled	1408988	1				
...						
...						
...						
Connector, without contacts, cable diameter: 6.5 mm ... 11 mm						
Female, straight			1027466	1		
Male, straight			1027465	1		
Connector, without contacts, cable diameter: 8 mm ... 13 mm						
Female, straight					1027480	1
Male, straight					1027479	1
...						
...						
...						
Crimp contacts for male connector, gold-plated, for conductor cross-section:						
Male, 1.5 mm ² , AWG 14			1029394	1	1029394	1
Male, 2.5 mm ²			1029388	1	1029388	1
PE male, 1.5 mm ² , AWG 14			1029398	1		
PE male, 2.5 mm ²			1029389	1		
PE female, 1.5 mm ² , AWG 14						1029401
PE female, 2.5 mm ²						1029393
Crimp contacts for female connector, gold-plated, for conductor cross-section:						
Female, 1.5 mm ² , AWG 14			1029395	1	1029396	1
Female, 2.5 mm ²			1029390	1	1029392	1
PE female, 1.5 mm ² , AWG 14			1029400	1		
PE female, 2.5 mm ²			1029391	1		
PE male, 1.5 mm ² , AWG 14						1029398
PE male, 2.5 mm ²						1029389

new

M12 POWER connectors, screw connection, crimp connection

Further power codings can be found on our website under web code:

i Your web code: #0024



S-coded, 2-, 3-pos.+PE



K-coded, 4-pos.+PE



	Technical data			Technical data		
	2-pos. + PE, unshielded	3-pos. + PE, unshielded	3-pos. + PE, shielded	4-pos. + PE, unshielded	4-pos. + PE, shielded	
General data						
Degree of pollution	3	3	3	3	3	
Degree of protection	IP67	IP67	IP65	IP67	IP65	
Connection method	Screw connection	Screw connection	Crimp connection	Screw connection	Crimp connection	
Connection cross section [mm ²]	0.75 mm ² ... 1.5 mm ²	0.75 mm ² ... 1.5 mm ²	1.5 mm ² ... 2.5 mm ²	1.5 mm ² ... 2.5 mm ²	1.5 mm ² ... 2.5 mm ²	
Electrical data						
Rated voltage	230 V AC	630 V AC	690 V AC	630 V AC	690 V AC	
Rated current	16 A (when using 1.5 mm ² conductors)	12 A (when using 1.5 mm ² conductors)	12 A (when using 1.5 mm ² conductors)	12 A (when using 2.5 mm ² conductors)	16 A (when using 2.5 mm ² conductors)	
Insulation resistance	> 10 GΩ	> 10 GΩ	≥ 100 MΩ	> 10 GΩ	≥ 100 MΩ	
Material data						
Material contact/contact surface	CuZn / Au	CuZn / Au	- / -	CuZn / Au	- / -	
Contact carrier material	PA	PA	PA	PA	PA	
Flammability rating in accordance with UL 94	V0	V0	V0	V0	V0	
Temperature data						
Male connector/female connector	[°C]	[°C]	[°C]	[°C]	[°C]	
	-40 ... 85	-40 ... 85	-40 ... 85	-40 ... 85	-40 ... 85	
	Ordering data			Ordering data		
	Order No.	Pcs./ Pkt.	Order No.	Pcs./ Pkt.	Order No.	Pcs./ Pkt.
Connector, cable diameter: 6 mm ... 8 mm						
Female, straight	1419640	1				
Male, straight	1419639	1				
Female, angled	1419642	1				
Male, angled	1419641	1				
Connector, cable diameter: 8 mm ... 10 mm						
Female, straight			1404642	1		
Male, straight			1404641	1		
Female, angled			1408987	1		
Male, angled			1408985	1		
Connector, without contacts, cable diameter: 6.5 mm ... 11 mm						
Female, straight			1027469	1		
Male, straight			1027467	1		
Connector, without contacts, cable diameter: 8 mm ... 13 mm						
Female, straight					1027476	1
Male, straight					1027474	1
Crimp contacts for male connector, gold-plated, for conductor cross-section:						
Male, 1.5 mm ² , AWG 14			1029394	1	1029394	1
Male, 2.5 mm ²			1029388	1	1029388	1
PE male, 1.5 mm ² , AWG 14			1029398	1		
PE male, 2.5 mm ²			1029389	1		
PE female, 1.5 mm ² , AWG 14					1029401	1
PE female, 2.5 mm ²					1029393	1
Crimp contacts for female connector, gold-plated, for conductor cross-section:						
Female, 1.5 mm ² , AWG 14			1029395	1	1029396	1
Female, 2.5 mm ²			1029390	1	1029392	1
PE female, 1.5 mm ² , AWG 14			1029400	1		
PE female, 2.5 mm ²			1029391	1		
PE male, 1.5 mm ² , AWG 14					1029398	1
PE male, 2.5 mm ²					1029389	1

Sensor/actuator cabling

M12 cabling for power applications

M12 POWER device connectors, modular, 25 mm square flange, pre-assembled



Flange housing, 2.7 mm housing bore holes



Preassembled contact carrier and insulating body with 0.5 m long litz wires

ERC

ERC

Technical data

Technical data

General data		
Degree of pollution	-	
Degree of protection	-	
Connection method	-	
Electrical data		
Rated voltage		
Rated current	-	
Overvoltage category	-	
Material data		
Material contact/contact surface	- / -	
Contact carrier material	-	
Cable gland material	Zinc die-cast, nickel-plated	
Cable type	-	
Temperature data		
Male connector/female connector	[°C] -40 ... 85	

S-coded, 3-pos. + PE		T-coded, 4-pos.	
3		3	
IP67		IP67	
Individual wires		Individual wires	
630 V		63 V	
12 A		12 A	
III		III	
CuZn / Au		CuZn / Au	
PA6		PA6	
-		-	
UL/cUL flexible hook-up wire		UL/cUL flexible hook-up wire	
-25 ... 85		-25 ... 85	

Ordering data

Ordering data

Description	Order No.	Pcs./Pkt.	Order No.	Pcs./Pkt.
	Square flange housing, with flat gasket			
	1424131	10		
Assembled contact carrier and insulating body, with 0.5 m litz wires and crimp contacts				
Male				

S-coded, 3-pos. + PE		T-coded, 4-pos.	
Order No.	Pcs./Pkt.	Order No.	Pcs./Pkt.
1424129	1	1424130	1

**M12 POWER device connectors,
2-pos.+PE, S-coded**

- M16 fastening thread
- With 0.5 m long litz wires
- S-coded



**S-coded,
2-pos. + PE**



Technical data

	Technical data	
	Front mounting	Rear mounting
General data		
Degree of pollution	3	3
Degree of protection	-	IP65 / IP67
Connection method	Individual wires	Individual wires
Electrical data		
Rated voltage	630 V	630 V
Rated current	16 A	16 A
Material data		
Material contact/contact surface	CuZn / Au	CuZn / Au
Contact carrier material	PA	PA
Flammability rating in accordance with UL 94	V0	V0
Cable type	UL/cUL flexible hook-up wire	UL/cUL flexible hook-up wire
Conductor cross section	1.31 mm ²	1.31 mm ²
Conductor cross section [AWG]	16	16
Temperature data		
Male connector/female connector [°C]	-25 ... 85	-25 ... 85

Ordering data

Description	Coding	Ordering data			
		Order No.	Pcs./Pkt.	Order No.	Pcs./Pkt.
		Front mounting		Rear mounting	
Power device connectors					
Female	S power	1411654	1	1411652	1
Male	S power	1411655	1	1411653	1

Accessories

Flat nut, with: M16 thread	SACC-E-MU-M16	1504097	100
-------------------------------	---------------	---------	-----

Sensor/actuator cabling

M12 cabling for power applications

M12 POWER device connectors, 3-pos.+PE, S-coded, 4-pos., T-coded

- M16 fastening thread
- With 0.5 m long litz wires



S-coded,
3-pos. + PE



T-coded,
4-pos.



Technical data

Technical data

General data	
Degree of pollution	
Degree of protection	
Connection method	
Electrical data	
Rated voltage	
Rated current	
Material data	
Material contact/contact surface	
Contact carrier material	
Flammability rating in accordance with UL 94	
Cable type	
Conductor cross section	
Conductor cross section	[AWG]
Temperature data	
Male connector/female connector	[°C]

Front mounting	Rear mounting
3	3
IP67	IP67
Individual wires	Individual wires
630 V	630 V
12 A	12 A
CuZn / Au	CuZn / Au
PA	PA
V0	V0
UL/cUL flexible hook-up wire	UL/cUL flexible hook-up wire
1.31 mm ²	1.31 mm ²
16	16
-25 ... 85	-25 ... 85

Front mounting	Rear mounting
3	3
IP67	IP67
Individual wires	Individual wires
63 V	63 V
12 A	12 A
CuZn / Au	CuZn / Au
PA	PA
V0	V0
UL/cUL flexible hook-up wire	UL/cUL flexible hook-up wire
1.31 mm ²	1.31 mm ²
16	16
-25 ... 85	-25 ... 85

Ordering data

Ordering data

Description
Power device connectors
Female
Male

Order No.	Pcs./Pkt.	Order No.	Pcs./Pkt.
Front mounting		Rear mounting	
1424137	1	1424133	1
1424139	1	1424132	1

Order No.	Pcs./Pkt.	Order No.	Pcs./Pkt.
Front mounting		Rear mounting	
1424138	1	1424134	1
1424140	1	1424136	1

Accessories

Accessories

Flat nut, with: M16 thread

SACC-E-MU-M16	1504097	100
---------------	---------	-----

SACC-E-MU-M16	1504097	100
---------------	---------	-----

**M12 POWER XL device connectors,
3-pos.+PE, S-coded,
4-pos., T-coded**

- M16 fastening thread
- With 0.5 m long litz wires
- Tightening limitation
- Wrench size 19



**S-coded,
3-pos. + PE**



**T-coded,
4-pos.**



	Technical data	
	Front mounting	Rear mounting
General data		
Degree of pollution	3	3
Degree of protection	IP65/IP67	IP65/IP67
Connection method	Individual wires	Individual wires
Electrical data		
Rated voltage	630 V	630 V
Rated current	12 A	12 A
Material data		
Material contact/contact surface	CuZn / Au	CuZn / Au
Contact carrier material	PA	PA
Flammability rating in accordance with UL 94	V0	V0
Cable type	UL/cUL flexible hook-up wire	UL/cUL flexible hook-up wire
Conductor cross section	1.31 mm ²	1.31 mm ²
Conductor cross section [AWG]	16	16
Temperature data		
Male connector/female connector [°C]	-25 ... 85	-25 ... 85



	Technical data	
	Front mounting	Rear mounting
General data		
Degree of pollution	3	3
Degree of protection	IP65/IP67	IP65/IP67
Connection method	Individual wires	Individual wires
Electrical data		
Rated voltage	63 V	63 V
Rated current	12 A	12 A
Material data		
Material contact/contact surface	CuZn / Au	CuZn / Au
Contact carrier material	PA	PA
Flammability rating in accordance with UL 94	V0	V0
Cable type	UL/cUL flexible hook-up wire	UL/cUL flexible hook-up wire
Conductor cross section	1.31 mm ²	1.31 mm ²
Conductor cross section [AWG]	16	16
Temperature data		
Male connector/female connector [°C]	-25 ... 85	-25 ... 85

Description	Ordering data			
	Front mounting		Rear mounting	
	Order No.	Pcs./Pkt.	Order No.	Pcs./Pkt.
Power device connectors				
Female	1411605	1	1411598	1
Male	1411607	1	1411603	1

Description	Ordering data			
	Front mounting		Rear mounting	
	Order No.	Pcs./Pkt.	Order No.	Pcs./Pkt.
Power device connectors				
Female	1411606	1	1411599	1
Male	1411608	1	1411604	1

Flat nut, with: M16 thread	Accessories	
	Order No.	Pcs./Pkt.
	SACC-E-MU-M16	1504097 100

Flat nut, with: M16 thread	Accessories	
	Order No.	Pcs./Pkt.
	SACC-E-MU-M16	1504097 100

Sensor/actuator cabling

M12 cabling for power applications

M12 POWER XL device connectors, 4-pos.+PE, K-coded

- M16 fastening thread
- With 0.2 m long litz wires
- Tightening limitation
- Wrench size 19

new



**K-coded,
cable cross section:
2.5 mm², 4-pos.+PE**



**K-coded,
cable cross section:
1.31 mm², 4-pos.+PE**

	Technical data				Technical data			
	Front mounting		Rear mounting		Front mounting		Rear mounting	
General data								
Degree of pollution	3		3		3		3	
Degree of protection	IP65/IP67		IP65/IP67		IP65/IP67		IP65/IP67	
Connection method	Individual wires		Individual wires		Individual wires		Individual wires	
Electrical data								
Rated voltage	630 V		630 V		630 V		630 V	
Rated current	16 A		16 A		12 A		12 A	
Material data								
Material contact/contact surface	CuZn / Au		CuZn / Au		CuZn / Au		CuZn / Au	
Contact carrier material	PA		PA		PA		PA	
Flammability rating in accordance with UL 94	V0		V0		V0		V0	
Cable type	PEX litz wire		PEX litz wire		UL/cUL flexible hook-up wire		UL/cUL flexible hook-up wire	
Conductor cross section	2.5 mm²		2.5 mm²		1.31 mm²		1.31 mm²	
Conductor cross section [AWG]	14		14		16		16	
Temperature data								
Male connector/female connector	-25 ... 85		-40 ... 85		-25 ... 85		-25 ... 85	
	Ordering data				Ordering data			
Description	Order No.	Pcs./Pkt.	Order No.	Pcs./Pkt.	Order No.	Pcs./Pkt.	Order No.	Pcs./Pkt.
	Front mounting		Rear mounting		Front mounting		Rear mounting	
Power device connectors								
Female	1415292	1	1415294	1	1425636	1	1425638	1
Male	1415291	1	1415293	1	1425635	1	1425637	1
	Accessories				Accessories			
Flat nut, with: M16 thread	SACC-E-MU-M16		1504097	100	SACC-E-MU-M16		1504097	100

M12 POWER XL device connectors, 4-pos., L-coded

- M16 fastening thread
- With 0.2 m long litz wires
- Tightening limitation
- Wrench size 19
- PROFINET-specified versions



new

L-coded,
cable cross section:
2.5 mm², 4-pos.

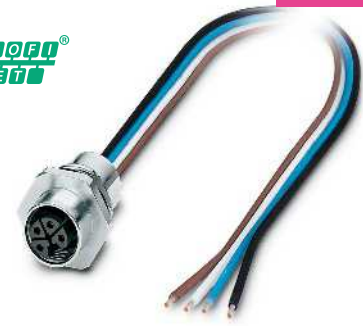

new

L-coded,
cable cross section:
1.31 mm², 4-pos.

	Technical data		Technical data	
	Front mounting	Rear mounting	Front mounting	Rear mounting
General data				
Degree of pollution	3	3	3	3
Degree of protection	IP65/IP67	IP65/IP67	IP65/IP67	IP65/IP67
Connection method	Individual wires	Individual wires	Individual wires	Individual wires
Electrical data				
Rated voltage	63 V	63 V	63 V	63 V
Rated current	16 A	16 A	12 A	12 A
Material data				
Material contact/contact surface	CuZn / Au	CuZn / Au	CuZn / Au	CuZn / Au
Contact carrier material	PA	PA	PA	PA
Flammability rating in accordance with UL 94	V0	V0	V0	V0
Cable type	PEX litz wire	PEX litz wire	UL/cUL flexible hook-up wire	UL/cUL flexible hook-up wire
Conductor cross section	2.5 mm ²	2.5 mm ²	1.31 mm ²	1.31 mm ²
Conductor cross section [AWG]	14	14	16	16
Temperature data				
Male connector/female connector [°C]	-25 ... 85	-25 ... 85	-25 ... 85	-25 ... 85
	Ordering data		Ordering data	
Description	Order No.	Pcs./Pkt.	Order No.	Pcs./Pkt.
	Front mounting		Rear mounting	
POWER device connector, PROFINET-specified				
Female	1425587	1	1425589	1
Male	1425586	1	1425588	1
	Accessories		Accessories	
Flat nut, with: M16 thread	SACC-E-MU-M16	1504097	100	
				SACC-E-MU-M16 1504097 100

Sensor/actuator cabling

M12 cabling for power applications

M12 POWER XL device connectors, 4-pos.+FE, L-coded

- M16 fastening thread
- With 0.2 m long litz wires
- Tightening limitation
- Wrench size 19
- PROFINET-specified versions



L-coded,
cable cross section:
2.5 mm², 4-pos.+FE



L-coded,
cable cross section:
1.31 mm², 4-pos.+FE

	Technical data				Technical data			
	Front mounting		Rear mounting		Front mounting		Rear mounting	
General data								
Degree of pollution	3		3		3		3	
Degree of protection	IP65/IP67		IP65/IP67		IP65/IP67		IP65/IP67	
Connection method	Individual wires		Individual wires		Individual wires		Individual wires	
Electrical data								
Rated voltage	63 V		63 V		63 V		63 V	
Rated current	16 A		16 A		12 A		12 A	
Material data								
Material contact/contact surface	CuZn / Au		CuZn / Au		CuZn / Au		CuZn / Au	
Contact carrier material	PA		PA		PA		PA	
Flammability rating in accordance with UL 94	V0		V0		V0		V0	
Cable type	PEX litz wire		PEX litz wire		UL/cUL flexible hook-up wire		UL/cUL flexible hook-up wire	
Conductor cross section	2.5 mm ²		2.5 mm ²		1.31 mm ²		1.31 mm ²	
Conductor cross section [AWG]	14		14		16		16	
Temperature data								
Male connector/female connector	-25 ... 85		-25 ... 85		-25 ... 85		-25 ... 85	
	Ordering data				Ordering data			
Description	Order No.	Pcs./Pkt.	Order No.	Pcs./Pkt.	Order No.	Pcs./Pkt.	Order No.	Pcs./Pkt.
	Front mounting		Rear mounting		Front mounting		Rear mounting	
Power device connectors								
Female	1415296	1	1415299	1				
Male	1415295	1	1415297	1				
POWER device connector, PROFINET-specified								
Female	1425583	1	1425585	1	1425628	1	1425630	1
Male	1425582	1	1425584	1	1425627	1	1425629	1
	Accessories				Accessories			
Flat nut, with: M16 thread	SACC-E-MU-M16		1504097	100	SACC-E-MU-M16		1504097	100

M12 POWER XL device connectors, 5-pos.+PE, M-coded

- M16 fastening thread
- With 0.2 m long litz wires
- Tightening limitation
- Wrench size 19



M-coded, 5-pos.+PE

Technical data		
	Front mounting	Rear mounting
General data		
Degree of pollution	3	3
Degree of protection	IP65/IP67	IP65/IP67
Connection method	Individual wires	Individual wires
Electrical data		
Rated voltage	630 V	630 V
Rated current	8 A	8 A
Material data		
Material contact/contact surface	CuZn / Au	CuZn / Au
Contact carrier material	PA	PA
Flammability rating in accordance with UL 94	V0	V0
Cable type	UL/cUL flexible hook-up wire	UL/cUL flexible hook-up wire
Conductor cross section	1.31 mm ²	1.31 mm ²
Conductor cross section [AWG]	16	16
Temperature data		
Male connector/female connector [°C]	-25 ... 85	-25 ... 85

Ordering data				
Description	Order No.	Pcs./Pkt.	Order No.	Pcs./Pkt.
	Front mounting		Rear mounting	
Power device connectors				
Female	1415301	1	1415303	1
Male	1415300	1	1415302	1

Accessories		
Flat nut, with: M16 thread	SACC-E-MU-M16	1504097 100

Sensor/actuator cabling

M12 cabling for power applications

M12 POWER cables, 2-pos.+PE, S-coded, cable type: PVC, unshielded

Notes:
For information about the cable qualities, see page 318

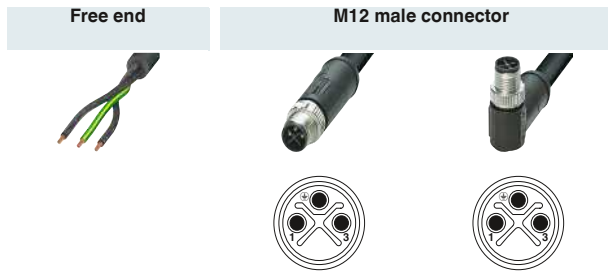

Free end	Ordering data		Ordering data		Ordering data	
	Order No.	Order No.	Order No.	Order No.	Order No.	Order No.
	1 m	1411636	1 m	1411640	1 m	1411640
	2 m	1411637	2 m	1411641	2 m	1411641
	5 m	1411638	5 m	1411642	5 m	1411642
	10 m	1411639	10 m	1411643	10 m	1411643
M12 female connector, straight 	1 m	1411644				
	2 m	1411645				
	5 m	1411646				
	10 m	1411647				
M12 female connector, connector, angled 	1 m	1411648				
	2 m	1411649				
	5 m	1411650				
	10 m	1411651				

Cable description	Cable type	Color coding		Pin assignment
PVC – black	PVC	BK1	1	1
		BK2	2	3
		GNYE		PE

		Technical data
		M12
Rated voltage		230 V AC
Rated current	[A]	16
Material contact M12		CuSn
Material contact surface M12		Ni/Au
Material handle M12		PA
Material, knurls		Zinc die-cast, nickel-plated
Degree of protection		IP65 / IP67 / IP68
Temperature data		
Male connector/female connector	[°C]	-25 ... 85

**M12 POWER cables,
3-pos.+PE, S-coded,
cable type: PUR**

Notes:
For information about the cable qualities, see page 318

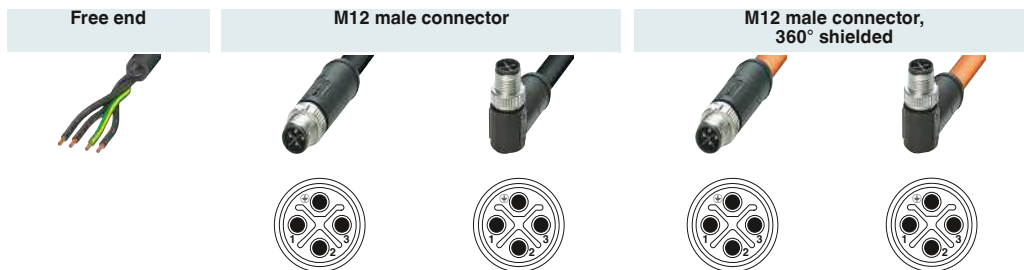

Free end	Ordering data	Ordering data	Ordering data	Ordering data	Ordering data	
	Order No.	Order No.	Order No.	Order No.	Order No.	
	1 m	1408835	1 m	1408839	1.5 m	1424104
	2 m	1408836	2 m	1408840	3 m	1424105
	5 m	1408837	5 m	1408841	5 m	1424245
	10 m	1408838	10 m	1408842	10 m	1424107
				1.5 m	1424108	
				3 m	1424109	
				5 m	1424110	
				10 m	1424111	

M12 female connector, straight	Ordering data	
	Order No.	
	1 m	1408843
	2 m	1408844
	5 m	1408845
	10 m	1408846

M12 female connector, angled	Ordering data	
	Order No.	
	1 m	1408848
	2 m	1408852
	5 m	1408853
	10 m	1408854

M12 female connector, straight, 360° shielded	Ordering data	
	Order No.	
	1.5 m	1424096
	3 m	1424097
	5 m	1424098
	10 m	1424099

M12 female connector, angled, 360° shielded	Ordering data	
	Order No.	
	1.5 m	1424100
	1.5 m	1424101
	1.5 m	1424102
	1.5 m	1424103

Cable description	Cable type	Color coding	Pin assignment
PUR, halogen-free – black (unshielded)	PUR	BK1	1
		BK2	2
		BK3	3
PUR, halogen-free – orange (shielded)	PUR	GNYE	PE

Technical data	
M12	
Rated voltage	690 V AC
Rated current	12 [A]
Material contact M12	CuZn
Material contact surface M12	Ni/Au
Material handle M12	PA
Material, knurls	Zinc die-cast, nickel-plated
Degree of protection	IP65 / IP67 / IP68
Temperature data	
Male connector/female connector	-25 ... 85 [°C]

Sensor/actuator cabling

M12 cabling for power applications

M12 POWER cables, 4-pos., T-coded, cable type: PUR

Notes:

For information about the cable qualities, see page 318

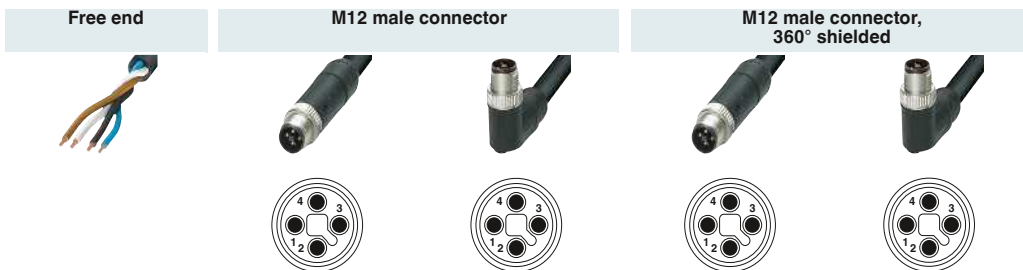

	Ordering data		Ordering data		Ordering data		Ordering data		Ordering data	
Free end	Order No.		Order No.		Order No.		Order No.		Order No.	
			1 m	1408812	1 m	1408816	1.5 m	1424120	1.5 m	1424124
			2 m	1408813	2 m	1408819	1.5 m	1424121	3 m	1424125
			5 m	1408814	5 m	1408820	1.5 m	1424122	5 m	1424126
			10 m	1408815	10 m	1408822	1.5 m	1424123	10 m	1424127
M12 female connector, straight			1 m	1408823	1 m	1408808				
			2 m	1408824	2 m	1408809				
			5 m	1408825	5 m	1408810				
			10 m	1408826	10 m	1408811				
M12 female connector, angled			1 m	1408827	1 m	1415196				
			2 m	1408828	2 m	1415197				
			5 m	1408829	5 m	1415198				
			10 m	1408830	10 m	1415199				
M12 female connector, straight, 360° shielded			1.5 m	1424112						
			3 m	1424113						
			5 m	1424114						
			10 m	1424115						
M12 female connector, angled, 360° shielded			1.5 m	1424116			1.5 m	1415202		
			3 m	1424117			3 m	1415203		
			5 m	1424118			5 m	1415204		
			10 m	1424128			10 m	1415205		

Cable description	Cable type	Color coding	Pin assignment
PUR, halogen-free – black	PUR	BN	1
		WH	2
		BK	4
		BU	3

		Technical data
		M12
Rated voltage		63 V DC
Rated current	[A]	12
Material contact M12		CuSn
Material contact surface M12		Ni/Au
Material handle M12		PA
Material, knurls		Zinc die-cast, nickel-plated
Degree of protection		IP65 / IP67 / IP68
Temperature data		
Male connector/female connector	[°C]	-25 ... 85

**M12 POWER cables,
4-pos., T-coded,
cable type: PVC, unshielded**

Notes:

For information about the cable qualities, see page 318

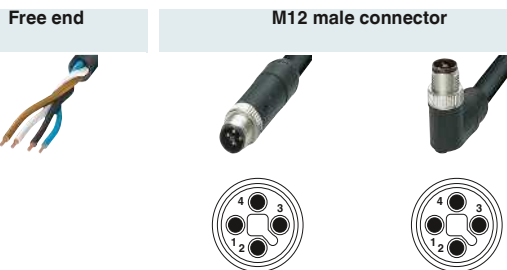

Free end	Ordering data		Ordering data		Ordering data	
	Order No.	Order No.	Order No.	Order No.	Order No.	Order No.
		1 m	1089952	1 m	1089958	
		2 m	1089953	2 m	1089961	
		5 m	1089955	5 m	1089965	
		10 m	1089956	10 m	1089968	
M12 female connector, straight 		1 m	1089970	1 m	1089988	
		2 m	1089971	2 m	1089997	
		5 m	1089972	5 m	1089998	
		10 m	1408826	10 m	1089973	
M12 female connector, angled 		1 m	1089977			
		2 m	1089981			
		5 m	1089984			
		10 m	1089987			

Cable description	Cable type	Color coding	Pin assignment
PVC – black (unshielded)	PVC	BN	1
		WH	2
		BK	4
		BU	3

Technical data	
M12	
Rated voltage	63 V DC
Rated current [A]	12
Material contact M12	CuSn
Material contact surface M12	Ni/Au
Material handle M12	PA
Material, knurls	Zinc die-cast, nickel-plated
Degree of protection	IP65 / IP67 / IP68
Temperature data	
Male connector/female connector [°C]	-25 ... 85

Sensor/actuator cabling

M12 cabling for power applications

M12 POWER cables, 4-pos.+PE, K-coded, cable type: PUR

Notes:
For information about the cable qualities, see page 318



Free end	Ordering data	Ordering data	Ordering data	Ordering data	Ordering data			
	Order No.	Order No.	Order No.	Order No.	Order No.			
	1.5 m	1414866	1.5 m	1414833	1.5 m	1414867	1.5 m	1414834
	3 m	1414870	3 m	1414837	3 m	1414871	3 m	1414838
	5 m	1414875	5 m	1414841	5 m	1414876	5 m	1414842
	10 m	1414879	10 m	1414846	10 m	1414880	10 m	1414847

M12 female connector, straight	Ordering data	Ordering data
	Order No.	Order No.
	1.5 m	1414770
	3 m	1414788
	5 m	1414804
	10 m	1414821

M12 female connector, angled	Ordering data	Ordering data
	Order No.	Order No.
	1.5 m	1414766
	3 m	1414784
	5 m	1414800
	10 m	1414817

M12 female connector, straight, 360° shielded	Ordering data	Ordering data
	Order No.	Order No.
	1.5 m	1414771
	3 m	1414789
	5 m	1414805
	10 m	1414822

M12 female connector, angled, 360° shielded	Ordering data	Ordering data
	Order No.	Order No.
	1.5 m	1414767
	3 m	1414785
	5 m	1414801
	10 m	1414818

Cable description	Cable type	Color coding	Pin assignment
PUR, halogen-free – black (unshielded)	PUR	BK1 1 BK2 2 BK3 3 BK4 4	1 2 3 4
PUR, halogen-free – orange (shielded)	PUR	GNYE PE	PE

Technical data	
M12	
Rated voltage	690 V AC
Rated current [A]	16
Material contact M12	CuSn
Material contact surface M12	Ni/Au
Material handle M12	PA
Material, knurls	Zinc die-cast, nickel-plated
Degree of protection	IP65 / IP67
Temperature data	
Male connector/female connector [°C]	-25 ... 85

**M12 POWER cables,
4-pos.+PE, K-coded,
cable type: PVC**

Notes:

For information about the cable qualities, see page 318

Free end



M12 male connector



Ordering data

Ordering data

Ordering data

Ordering data

Ordering data

Free end

Order No.

Order No.

Order No.

Order No.

Order No.



1.5 m
3 m
5 m
10 m

[1414868](#)
[1414872](#)
[1414877](#)
[1414881](#)

1.5 m
3 m
5 m
10 m

[1414835](#)
[1414839](#)
[1414843](#)
[1414848](#)

M12 female connector, straight



1.5 m
3 m
5 m
10 m

[1414780](#)
[1414796](#)
[1414812](#)
[1414829](#)

M12 female connector, angled



1.5 m
3 m
5 m
10 m

[1414774](#)
[1414792](#)
[1414808](#)
[1414825](#)

Cable description	Cable type	Color coding	Pin assignment
PVC – black (unshielded)	PVC	BK1	1
		BK2	2
		BK3	3
		BK4	4
		GNYE	PE

Technical data

		M12
Rated voltage		690 V AC
Rated current	[A]	16
Material contact M12		CuSn
Material contact surface M12		Ni/Au
Material handle M12		PA
Material, knurls		Zinc die-cast, nickel-plated
Degree of protection		IP65 / IP67
Temperature data		
Male connector/female connector	[°C]	-25 ... 85

Sensor/actuator cabling

M12 cabling for power applications

M12 POWER cables, 4-pos.+FE, L-coded, cable type: PUR, unshielded

Notes:
 For information about the cable qualities, see page 318
 For shielded power cables, visit phoenixcontact.net/products

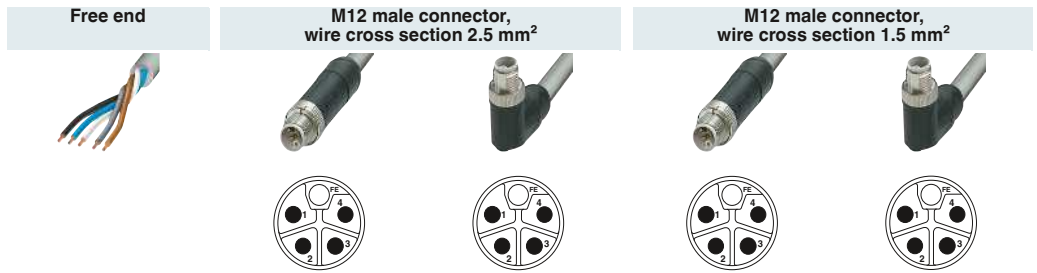

Free end	Ordering data	Ordering data	Ordering data	Ordering data	Ordering data	
	Order No.	Order No.	Order No.	Order No.	Order No.	
		1.5 m	1414883	1.5 m	1414850	
			3 m	1414887	3 m	1414854
			5 m	1414891	5 m	1414858
			10 m	1414895	10 m	1414862
M12 female connector, straight, wire cross section 2.5 mm² 	1.5 m	1414772	0.3 m	1425009		
	3 m	1414790	0.6 m	1425010		
	5 m	1414806	1.5 m	1425011		
	10 m	1414823	3 m	1425012		
M12 female connector, angled, wire cross section 2.5 mm² 	1.5 m	1414768				
	3 m	1414786				
	5 m	1414802				
	10 m	1414819				
M12 female connector, straight, wire cross section 1.5 mm² 	1.5 m	1424601		0.3 m	1425017	
	3 m	1424602		0.6 m	1425018	
	5 m	1424603		1.5 m	1425019	
	10 m	1424604		3 m	1425020	
M12 female connector, angled, wire cross section 1.5 mm² 	1.5 m	1424605				
	3 m	1424606				
	5 m	1424607				
	10 m	1424608				

Cable description	Cable type	Color coding	Pin assignment
PUR, halogen-free – gray Cable type 280 for 2.5 mm ²	280	BN	1
		WH	2
PUR, halogen-free – gray Cable type 290 for 1.5 mm ²	290	BU	3
		BK	4
		GY	5

		Technical data
		M12
Rated voltage		63 V DC
Rated current	[A]	16
Material contact M12		CuSn
Material contact surface M12		Ni/Au
Material handle M12		PA
Material, knurls		Zinc die-cast, nickel-plated
Degree of protection		IP65 / IP67
Temperature data		
Male connector/female connector	[°C]	-25 ... 85

**M12 POWER cables,
4-pos.+FE, L-coded,
cable type: PVC, unshielded**

Notes:
For information about the cable qualities, see page 318
For shielded power cables, visit phoenixcontact.net/products

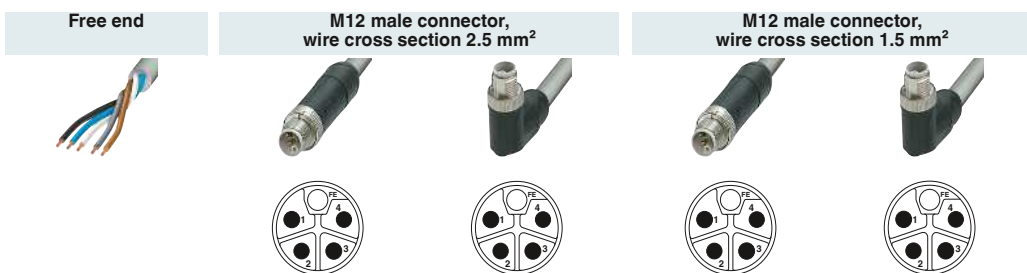

Free end	Ordering data		Ordering data		Ordering data		Ordering data	
	Order No.	Order No.	Order No.	Order No.	Order No.	Order No.	Order No.	
	1.5 m	1414885	1.5 m	1414852	1.5 m	1424609	1.5 m	1424613
	3 m	1414889	3 m	1414856	3 m	1424610	3 m	1424614
	5 m	1414893	5 m	1414860	5 m	1424611	5 m	1424615
	10 m	1414897	10 m	1414864	10 m	1424612	10 m	1424616
M12 female connector, straight, wire cross section 2.5 mm² 	1.5 m	1414782	0.3 m	1425013				
	3 m	1414798	0.6 m	1425014				
	5 m	1414814	1.5 m	1425015				
	10 m	1414831	3 m	1425016				
M12 female connector, angled, wire cross section 2.5 mm² 	1.5 m	1414777						
	3 m	1414794						
	5 m	1414810						
	10 m	1414827						
M12 female connector, straight, wire cross section 1.5 mm² 	1.5 m	1424617			0.3 m	1425021		
	1.5 m	1424618			0.6 m	1425022		
	1.5 m	1424619			1.5 m	1425023		
	1.5 m	1424620			3 m	1425024		
M12 female connector, angled, wire cross section 1.5 mm² 	1.5 m	1424621						
	3 m	1424622						
	5 m	1424623						
	10 m	1424624						

Cable description	Cable type	Color coding	Pin assignment
PVC – gray Cable type 500 for 2.5 mm ²	500	BN	1
		WH	2
PVC – gray Cable type 510 for 1.5 mm ²	510	BU	3
		BK	4
		GY	5

Technical data	
M12	
Rated voltage	63 V DC
Rated current [A]	16
Material contact M12	CuSn
Material contact surface M12	Ni/Au
Material handle M12	PA
Material, knurls	Zinc die-cast, nickel-plated
Degree of protection	IP65 / IP67
Temperature data	
Male connector/female connector [°C]	-25 ... 85

Sensor/actuator cabling

M12 cabling for power applications

M12 POWER cables, 4-pos., L-coded, cable type: PUR, unshielded

Notes:
 For information about the cable qualities, see page 318
 For shielded power cables, visit phoenixcontact.net/products



	Ordering data		Ordering data		Ordering data		Ordering data		Ordering data	
Free end	Order No.	Order No.	Order No.	Order No.	Order No.	Order No.	Order No.	Order No.	Order No.	
		1.5 m	1425065	1.5 m	1425069	1.5 m	1425025	1.5 m	1425029	
		3 m	1425066	3 m	1425070	3 m	1425026	3 m	1425030	
		5 m	1425067	5 m	1425071	5 m	1425027	5 m	1425031	
		10 m	1425068	10 m	1425072	10 m	1425028	10 m	1425032	
M12 female connector, straight, wire cross section 2.5 mm²		1.5 m	1425073	0.3 m	1425081					
		3 m	1425074	0.6 m	1425082					
		5 m	1425075	1.5 m	1425083					
		10 m	1425076	3 m	1425084					
M12 female connector, angled, wire cross section 2.5 mm²		1.5 m	1425077							
		3 m	1425078							
		5 m	1425079							
		10 m	1425080							
M12 female connector, straight, wire cross section 1.5 mm²		1.5 m	1425033			0.3 m	1425041			
		3 m	1425034			0.6 m	1425042			
		5 m	1425035			1.5 m	1425043			
		10 m	1425036			3 m	1425044			
M12 female connector, angled, wire cross section 1.5 mm²		1.5 m	1425037							
		3 m	1425038							
		5 m	1425039							
		10 m	1425040							

Cable description	Cable type	Color coding	Pin assignment
PUR, halogen-free – black Cable type PUR for 2.5 mm ²	PUR	BN WH	1 2
PUR, halogen-free – black Cable type 105 for 1.5 mm ²	105	BU BK	3 4

		Technical data
		M12
Rated voltage		63 V (DC) / 63 V DC
Rated current	[A]	16
Material contact M12		CuSn
Material contact surface M12		Ni/Au
Material handle M12		PA
Material, knurls		Zinc die-cast, nickel-plated
Degree of protection		IP65 / IP67
Temperature data		
Male connector/female connector	[°C]	-25 ... 85

**M12 POWER cables,
4-pos., L-coded,
cable type: PVC, unshielded**

Notes:
For information about the cable qualities, see page 318
For shielded power cables, visit phoenixcontact.net/products



Free end	Ordering data	Ordering data	Ordering data	Ordering data	Ordering data			
	Order No.	Order No.	Order No.	Order No.	Order No.			
	1.5 m	1425085	1.5 m	1425089	1.5 m	1425045	1.5 m	1425049
	3 m	1425086	3 m	1425090	3 m	1425046	3 m	1425050
	5 m	1425087	5 m	1425091	5 m	1425047	5 m	1425051
	10 m	1425088	10 m	1425092	10 m	1425048	10 m	1425052
M12 female connector, straight, wire cross section 2.5 mm² 	1.5 m	1425093	0.3 m	1425101				
	3 m	1425094	0.6 m	1425102				
	5 m	1425095	1.5 m	1425103				
	10 m	1425096	3 m	1425104				
M12 female connector, angled, wire cross section 2.5 mm² 	1.5 m	1425097						
	3 m	1425098						
	5 m	1425099						
	10 m	1425100						
M12 female connector, straight, wire cross section 1.5 mm² 	1.5 m	1425053			0.3 m	1425061		
	3 m	1425054			0.6 m	1425062		
	5 m	1425055			1.5 m	1425063		
	10 m	1425056			3 m	1425064		
M12 female connector, angled, wire cross section 1.5 mm² 	1.5 m	1425057						
	3 m	1425058						
	5 m	1425059						
	10 m	1425060						

Cable description	Cable type	Color coding	Pin assignment
PVC – black Cable type PVC for 2.5 mm ²	PVC	BN	1
		WH	2
PVC – black Cable type 110 for 1.5 mm ²	110	BU	3
		BK	4

		Technical data
		M12
Rated voltage		63 V DC
Rated current	[A]	16
Material contact M12		CuSn
Material contact surface M12		Ni/Au
Material handle M12		PA
Material, knurls		Zinc die-cast, nickel-plated
Degree of protection		IP65 / IP67
Temperature data		
Male connector/female connector	[°C]	-25 ... 85

Sensor/actuator cabling

M12 cabling for power applications

M12 POWER cables, 5-pos.+PE, M-coded, cable type: PUR

Notes:

For information about the cable qualities, see page 318

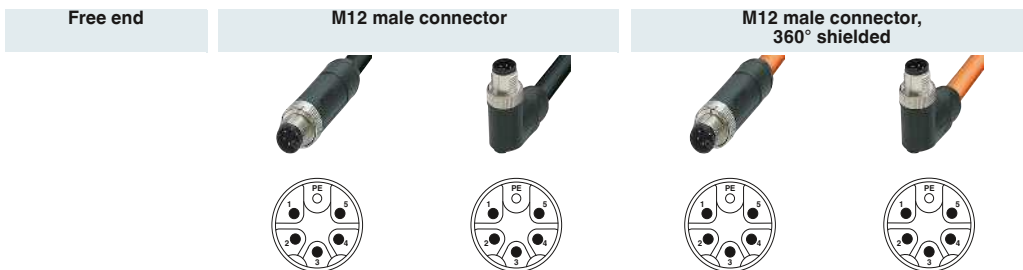

Free end	Ordering data		Ordering data		Ordering data		Ordering data	
	Order No.	Order No.	Order No.	Order No.	Order No.	Order No.	Order No.	
	1.5 m	1414949	1.5 m	1414932	1.5 m	1414950	1.5 m	1414933
	3 m	1414953	3 m	1414936	3 m	1414954	3 m	1414937
	5 m	1414957	5 m	1414941	5 m	1414958	5 m	1414942
	10 m	1414961	10 m	1414945	10 m	1414962	10 m	1414946

M12 female connector, straight

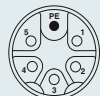

1.5 m	1414901
3 m	1414910
5 m	1414918
10 m	1414926

M12 female connector, angled



1.5 m	1414899
3 m	1414907
5 m	1414916
10 m	1414924

M12 female connector, straight, 360° shielded

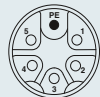

1.5 m	1414902
3 m	1414911
5 m	1414919
10 m	1414927

M12 female connector, angled, 360° shielded

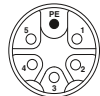

1.5 m	1414900
3 m	1414908
5 m	1414917
10 m	1414925

Cable description	Cable type	Color coding	Pin assignment
PUR, halogen-free – black (unshielded)	PUR	BK1	1
		BK2	2
		BK3	3
		BK4	4
		BK5	5
PUR, halogen-free – orange (shielded)	PUR	GNYE	PE

Technical data

		M12
Rated voltage		690 V AC
Rated current	[A]	8
Material contact M12		CuSn
Material contact surface M12		Ni/Au
Material handle M12		PA
Material, knurls		Zinc die-cast, nickel-plated
Degree of protection		IP65 / IP67
Temperature data		
Male connector/female connector	[°C]	-25 ... 85

M12 POWER cables, 5-pos.+PE, M-coded, cable type: PVC

Notes:
For information about the cable qualities, see page 318

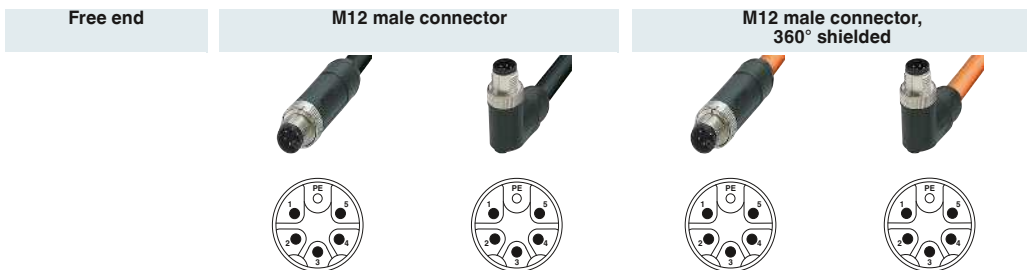

Free end	Ordering data	Ordering data	Ordering data	Ordering data	Ordering data	
	Order No.	Order No.	Order No.	Order No.	Order No.	
	1.5 m	1414951	1.5 m	1414934	1.5 m	1414952
	3 m	1414955	3 m	1414939	3 m	1414956
	5 m	1414959	5 m	1414943	5 m	1414960
	10 m	1414963	10 m	1414947	10 m	1414964
					1.5 m	1414935
					3 m	1414940
					5 m	1414944
					10 m	1414948

M12 female connector, straight



1.5 m	1414905
3 m	1414914
5 m	1414922
10 m	1414930

M12 female connector, angled



1.5 m	1414903
3 m	1414912
5 m	1414920
10 m	1414928

M12 female connector, straight, 360° shielded



1.5 m	1414906
3 m	1414915
5 m	1414923
10 m	1414931

M12 female connector, angled, 360° shielded



1.5 m	1414904
3 m	1414913
5 m	1414921
10 m	1414929

Cable description	Cable type	Color coding	Pin assignment
PVC – black (unshielded)	PVC	BK1	1
		BK2	2
		BK3	3
PVC – orange (shielded)	PVC	BK4	4
		BK5	5
		GNYE	PE

Technical data	
M12	
Rated voltage	690 V AC
Rated current [A]	8
Material contact M12	CuSn
Material contact surface M12	Ni/Au
Material handle M12	PA
Material, knurls	Zinc die-cast, nickel-plated
Degree of protection	IP65 / IP67
Temperature data	
Male connector/female connector [°C]	-25 ... 85

Sensor/actuator cabling

M12 cabling for power applications

Y distributors for M12 POWER connectors



Y-distributor, T-coded, 4-pos.

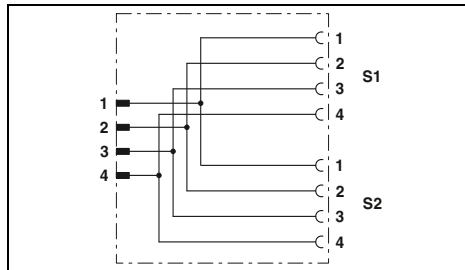

Technical data

General data	
Degree of pollution	3
Degree of protection	IP65 / IP67
Electrical data	
Rated voltage	63 V DC
Rated current	2x 12 A (at 40°C)
Material data	
Contact material	CuZn
Contact surface material	Ni/Au
Flammability rating in accordance with UL 94	HB
Temperature data	
Male connector/female connector	[°C] -25 ... 80

Ordering data

Description	Center distance	Type	Order No.	Pcs./Pkt.
Y distributor , unshielded, M12 male to 2 x M12 female	21 mm	SAC-4PY-MT/2XFV VP	1410632	5

Power distributors for M12 POWER connectors



**Power distributor
with plug-in crimp connection,
horizontal**

Technical data			
General data			
Degree of protection	IP66 / IP67		
Electrical data			
Rated voltage	24 V DC		
Perm. operating voltage	30.5 V DC		
Rated current for each I/O signal	10 A (M12 diagnostic socket for each channel max. 50 mA)		
Rated current per slot	2x 9.25 A (at 40°C)		
Total rated current	-		
Housing material	PBT		
Dimensions			
Width x height x length [mm]	60 x 52 x 212		
Temperature data			
Distributor box	-25°C ... 60°C		
Ordering data			
Description	Type	Order No.	Pcs./Pkt.
Power distributor , M12 female, 4 slots, 4-pos., unshielded, status indicator: yes			
- with diagnostics port	SACB-4/T-L-8FUSE DIAG CT AXL	1411048	1
- without diagnostic port	SACB-4/T-L-8FUSE CT AXL	1413929	1
Accessories			
M12 screw plug fast locking system			
for unused M12 sockets of sensor/actuator cables, boxes, and device connectors	PROT-MS SCO	1553129	5
UniCard , for labeling Phoenix Contact devices, AxioLine			
Lettering field size: 7 x 10 mm, 30 individual labels	UCT-EM (7X10)	0830765	10
Torque screwdriver			
With preset torque of 0.4 Nm and 4 mm hexagonal drive	TSD 04 SAC	1208429	1
Nut			
for assembling sensor/actuator cables with M12 connector and M12 connectors for assembly, with a knurl diameter of 15 mm, for 4 mm hexagonal drive	SAC BIT M12-D15	1208432	1
Nut			
for assembling M12 connectors for assembly, with a knurl diameter of 20 mm, for 4 mm hexagonal drive	SACC BIT M12-D20	1208445	1

Sensor/actuator cabling

By the meter

Cable coils for sensor cables

The standard SAC cables are also available in 100 m cable coils for connecting the M8 and M12 connectors for assembly.

Cables between 110 m and 500 m in length are supplied on cable drums. Please refer to the ordering example below.

Notes:
For information about the cable qualities, see page 318



Cable coil, 100 m, unshielded

Description	Ordering data		
	Type	Order No.	Pcs./Pkt.
PUR, halogen-free - black, cable type: PUR			
3 x 0.25 mm ² , conductor colors: BN/BU/BK	SAC-3P-100,0-PUR/0,25	1501689	1
3 x 0.34 mm ² , conductor colors: BN/BU/BK	SAC-3P-100,0-PUR/0,34	1501650	1
4 x 0.25 mm ² , conductor colors: BN/WH/BU/BK	SAC-4P-100,0-PUR/0,25	1501692	1
4 x 0.34 mm ² , conductor colors: BN/WH/BU/BK	SAC-4P-100,0-PUR/0,34	1501663	1
5 x 0.34 mm ² , conductor colors: BN/WH/BU/BK/GNYE	SAC-5P-100,0-PUR/0,34	1501676	1
6 x 0.25 mm ² , conductor colors: BN/WH/BU/BK/GY/PK	SAC-6P-100,0-PUR/0,25	1550614	1
8 x 0.25 mm ² , conductor colors: WH/BN/GN/YE/GY/PK/BU/RD	SAC-8P-100,0-PUR/0,25	1550630	1
PVC - black, cable type: PVC			
3 x 0.25 mm ² , conductor colors: BN/BU/BK	SAC-3P-100,0-PVC/0,25	1501854	1
3 x 0.34 mm ² , conductor colors: BN/BU/BK	SAC-3P-100,0-PVC/0,34	1501825	1
4 x 0.25 mm ² , conductor colors: BN/WH/BU/BK	SAC-4P-100,0-PVC/0,25	1501867	1
4 x 0.34 mm ² , conductor colors: BN/WH/BU/BK	SAC-4P-100,0-PVC/0,34	1501838	1
5 x 0.34 mm ² , conductor colors: BN/WH/BU/BK/GNYE	SAC-5P-100,0-PVC/0,34	1501841	1
8 x 0.25 mm ² , conductor colors: WH/BN/GN/YE/GY/PK/BU/RD	SAC-8P-100,0-PVC/0,25	1550698	1
12 x 0.14 mm ² , conductor colors: BN/BU/WH/GN/PK/YE/BK/GY/RD/VT/GYPK/RDBU	SAC-12P-100,0-PVC/0,14	1441532	1
17 x 0.14 mm ² , conductor colors: BN/BU/WH/GN/PK/YE/BK/GY/RD/VT/GYPK/RDBU/WHGN/BNGN/WHYE/YEBN/WHGY	SAC-17P-100,0-PVC/0,14	1441545	1
PUR/PVC - black, twisted pair, cable type: 35T			
12 x 0.14 mm ² , conductor colors: (BN/BU)/(WH/GN)/(PK/YE)/(BK/GY)/(RD/VT)/(GYPK/RDBU)			

Ordering example for cable drums with variable cable length:

For cable type: PVC, black, 5 x 0.34 mm², shielded and 340 m in length, the ordering data is as follows:

Order No. 1408527	Length [m] 340
Increment: 10 m	
Minimum length: 110 m	
Maximum length: 500 m	



Cable drum, 110 m to 500 m, unshielded



Cable coil, 100 m, shielded



Cable drum, 110 m to 500 m, shielded

Ordering data			Ordering data			Ordering data		
Type	Order No.	Pcs./Pkt.	Type	Order No.	Pcs./Pkt.	Type	Order No.	Pcs./Pkt.
SAC-3P-PUR-0,25/...	1408505	1	SAC-3P-100,0-PUR/SH-0,25	1526525	1	SAC-3P-PUR-0,25-SH/...	1408511	1
SAC-3P-PUR-0,34/...	1408506	1	SAC-3P-100,0-PUR/SH-0,34	1501702	1	SAC-3P-PUR-0,34-SH/...	1408512	1
SAC-4P-PUR-0,25/...	1408507	1	SAC-4P-100,0-PUR/SH-0,25	1535794	1	SAC-4P-PUR-0,25-SH/...	1408513	1
SAC-4P-PUR-0,34/...	1408508	1	SAC-4P-100,0-PUR/SH-0,34	1501715	1	SAC-4P-PUR-0,34-SH/...	1408514	1
SAC-5P-PUR-0,34/...	1408509	1	SAC-5P-100,0-PUR/SH-0,34	1501728	1	SAC-5P-PUR-0,34-SH/...	1408515	1
SAC-8P-PUR-0,25/...	1408510	1	SAC-6P-100,0-PUR/SH-0,14	1550627	1	SAC-8P-PUR-0,25-SH/...	1408516	1
SAC-8P-PUR-0,25/...	1408510	1	SAC-8P-100,0-PUR/SH-0,25	1550643	1			
SAC-3P-PVC-0,25/...	1408518	1				SAC-3P-PVC-0,34-SH/...	1408525	1
SAC-3P-PVC-0,34/...	1408519	1	SAC-3P-100,0-PVC/SH-0,34	1550656	1			
SAC-4P-PVC-0,25/...	1408521	1				SAC-4P-PVC-0,34-SH/...	1408526	1
SAC-4P-PVC-0,34/...	1408522	1	SAC-4P-100,0-PVC/SH-0,34	1550669	1			
SAC-5P-PVC-0,34/...	1408523	1	SAC-5P-100,0-PVC/SH-0,34	1550672	1	SAC-5P-PVC-0,34-SH/...	1408527	1
SAC-8P-PVC-0,25/...	1408524	1	SAC-8P-100,0-PVC/SH-0,25	1550708	1	SAC-8P-PVC-0,25-SH/...	1408528	1
			SAC-12P-100,0-35T/SH-0,14	1405789	1			

Sensor/actuator cabling

By the meter

Cable coils for valve connector cables

The special SAC cables are also available in 100 m cable coils for connecting the valve connectors for assembly.

Cables between 110 m and 500 m in length are supplied on cable drums. Please refer to the ordering example below.

Notes:
For information about the cable qualities, see page 318



Cable coil, 100 m, unshielded

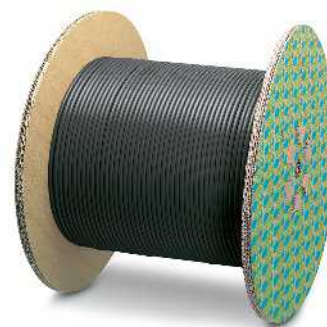

Cable drum, 110 m to 500 m, unshielded

Description	Ordering data			Ordering data		
	Type	Order No.	Pcs./Pkt.	Type	Order No.	Pcs./Pkt.
PUR, halogen-free - black, cable type: PUR						
3 x 0.5 mm ² , conductor colors: BK 1/BK 2/GNYE	SAC-3P-100,0-PUR/0,5	1457393	1	SAC-3P-PUR-0,5/...	1408529	1
5 x 0.5 mm ² , conductor colors: BK 1/BK 2/BK 3/BK 4/GNYE	SAC-5P-100,0-PUR/0,5	1457403	1	SAC-5P-PUR-0,5/...	1408530	1
PVC - black, cable type: 534						
3 x 0.75 mm ² , conductor colors: BK 1/BK 2/GNYE	SAC-3P-100,0-534/0,75	1457432	1			
5 x 0.75 mm ² , conductor colors: BK 1/BK 2/BK 3/BK 4/GNYE	SAC-5P-100,0-534/0,75	1457445	1			

Ordering example for cable drums with variable cable length:

For cable type: PUR, halogen-free, black, 5 x 0.5 mm², unshielded and 340 m in length, the ordering data is as follows:

Order No.	Length [m]
1408530	340
	Increment: 10 m Minimum length: 110 m Maximum length: 500 m

Master cable coils for sensor/actuator boxes

Master cable coils are available for distributor boxes with spring connection or plug-in screw connection. Similarly, master cables can also be connected to hoods and M23 sockets for assembly.

Notes:

For information about the cable qualities, see page 330



Description	Ordering data		
	Type	Order No.	Pcs./Pkt.
Master cable coil with PE conductor, PUR/PVC, unshielded, length: 50 m			
4 x 0.34 mm ² / 3 x 0.75 mm ²	SACB- 4X0,34/ 3X0,75-50,0 PUR	1503328	1
6 x 0.34 mm ² / 3 x 0.75 mm ²	SACB- 6X0,34/ 3X0,75-50,0 PUR	1503331	1
8 x 0.34 mm ² / 3 x 0.75 mm ²	SACB- 8X0,34/ 3X0,75-50,0 PUR	1503344	1
8 x 0.5 mm ² / 3 x 1.0 mm ²	SACB- 8X0,5/ 3X1,0-50,0 PUR	1503357	1
12 x 0.5 mm ² / 3 x 1.0 mm ²	SACB-12X0,5/ 3X1,0-50,0 PUR	1503360	1
16 x 0.5 mm ² / 3 x 1.0 mm ²	SACB-16X0,5/ 3X1,0-50,0 PUR	1503373	1
Master cable coil with PE conductor, PUR/PVC, unshielded, length: 200 m			
16 x 0.5 mm ² / 3 x 1.0 mm ²	SACB-16X0,5/ 3X1,0-200,0 PUR	1559893	1
Master cable coil with PE conductor, PUR/PVC, shielded, length: 50 m			
8 x 0.5 mm ² / 3 x 1.0 mm ²	SACB-8X0,5/3X1,0-50 PUR SH	1401240	1
16 x 0.5 mm ² / 3 x 1.0 mm ²	SACB-16X0,5/3X1,0-50 PUR SH	1539156	1
Master cable coil with PE conductor, PUR/PP halogen-free, unshielded, length: 50 m			
8 x 0.5 mm ² / 3 x 1.0 mm ²	SACB-8X0,5/3X1,0-50,0 HPUR	1401690	1
16 x 0.5 mm ² / 3 x 1.0 mm ²	SACB-16X0,5/ 3X1,0-50,0 VPUR	1430938	1
Master cable coil with PE conductor, PUR/PP, halogen-free, highly flexible, unshielded, length: 50 m			
16 x 0.5 mm ² / 3 x 1.0 mm ²	SACB-16X0,5/ 3X1,0-50,0 80MC	1402304	1
Master cable coil without PE conductor, PUR/PVC, unshielded, length: 50 m			
4 x 0.34 mm ² / 2 x 0.75 mm ²	SACB- 4X0,34/2X0,75-50 PUR	1517576	1
6 x 0.34 mm ² / 2 x 0.75 mm ²	SACB- 6X0,34/2X0,75-50 PUR	1517589	1
8 x 0.34 mm ² / 2 x 0.75 mm ²	SACB- 8X0,34/2X0,75-50 PUR	1517592	1
10 x 0.34 mm ² / 2 x 0.75 mm ²	SACB-10X0,34/2X0,75-50 PUR	1517602	1
16 x 0.34 mm ² / 2 x 0.75 mm ²	SACB-16X0,34/2X0,75-50 PUR	1539350	1

Accessories

Assembly tools for sensor/actuator cables

The screwdriver with preset torque is the ideal tool for screwing in all M12 and M8 circular connectors with lengthwise knurl. The advantage of this tool becomes particularly evident when connecting distributor boxes. The tight arrangement and the large number of slots rarely makes it possible to install them correctly by hand. Thanks to the open design of the top unit, tracking is especially easy when screwing in.



		Ordering data		
Description		Type	Order No.	Pcs./Pkt.
Torque screwdriver with preset torque of 0.2 Nm and 4 mm hexagonal drive	①	TSD 02 SAC	1208487	1
Nut for assembling M8 connectors with longitudinal knurl and a knurl diameter of 10 mm, for 4 mm hexagonal drive	②	SAC BIT M8-D10	1208461	1
Nut for assembling M8 connectors with longitudinal knurl and a knurl diameter of 12 mm, for 4 mm hexagonal drive	③	SACC BIT M8-D12	1208474	1
Torque screwdriver With preset torque of 0.4 Nm and 4 mm hexagonal drive	④	TSD 04 SAC	1208429	1
Nut for assembling sensor/actuator cables with M12 connector and M12 connectors for assembly, with a knurl diameter of 15 mm, for 4 mm hexagonal drive	⑤	SAC BIT M12-D15	1208432	1
for assembling sensor/actuator cables with M12 connector and M12 connectors for assembly, with a knurl diameter of 16 mm, for 4 mm hexagonal drive		SAC BIT M12-D16	1200305	1
Nut for assembling M12 connectors for assembly, with a knurl diameter of 20 mm, for 4 mm hexagonal drive	⑥	SACC BIT M12-D20	1208445	1

Assembly tools for sensor/actuator cables

To achieve tight plug-in connections, we recommend using assembly tools. M12 and 7/8" circular connectors can be assembled using a torque screwdriver and plug attachment.

The benefits of the plug attachment become particularly clear when connecting the connectors to the distributor boxes. Thanks to the open design, it enables quick adjustment and installation even when space is at a premium.

The version for M12 connectors with hexagonal high-grade steel knurl is also made from high-grade steel. This prevents the connector knurls from being contaminated by corrosive materials.

For greater flexibility, screwdrivers with adjustable torque are available. When used in conjunction with the adapter insert, the available nuts can also be accommodated.



		Ordering data		
Description		Type	Order No.	Pcs./Pkt.
Torque screwdriver with a preset torque of 0.8 Nm and a 4 mm hexagonal drive	①	TSD 08 SAC	1212597	1
Nut for assembling 7/8" connectors, with a knurl diameter of 25 mm, with 4 mm hexagonal drive	②	SAC BIT MIN-D25	1212512	1
Torque screwdriver with preset torque of 0.4 Nm and 4 mm hexagonal drive	③	TSD 04 SAC	1208429	1
Nut for assembling sensor/actuator cables with M12 connector and M12 connectors for assembly, with a hexagonal knurl wrench size of 14 mm, with 4 mm hexagonal drive	④	SAC BIT M12-W14	1212513	1
Torque screwdriver , accuracy in accordance with standard EN ISO 6789 adjustable from 0.3 ... 1.2 Nm adjustable from 1.2 ... 3 Nm adjustable from 3 ... 6 Nm	⑤	TSD-M 1,2NM TSD-M 3NM TSD-M 6NM	1212224 1212225 1212226	1 1 1
Adapter insert for torque screwdrivers with adjustable torque, for accommodating plug attachments with 4 mm hexagonal drive	⑥	TSD-M SAC-BIT ADAPTER	1212600	1

Sealing elements

During transport or when in the field, unused plug-in connections must be protected or sealed. Plastic or metal screw plugs, sealing caps, and sealing plugs can be used for this. IP65/IP67 and IP69K protection is achieved.



Description	Ordering data		
	Type	Order No.	Pcs./Pkt.
M5 screw plug for unused M5 sockets of sensor/actuator cables, boxes, and device connectors	① PROT-M5	1533288	10
M8 screw plug for unused M8 sockets of sensor/actuator cables, boxes, and device connectors	② PROT-M8	1682540	5
M12 screw plug for unused M12 sockets of sensor/actuator cables, boxes, and device connectors	③ PROT-M12	1680539	5
M12 screw plug fast locking system for unused M12 sockets of sensor/actuator cables, boxes, and device connectors	④ PROT-MS SCO	1553129	5
M12 sealing cap for unused M12 connectors of sensor/actuator cables, device connectors, and I/O devices in the field	⑤ PROT-M12 FS	1560251	5
M12 screw plug, metal for unused M12 sockets of shielded sensor/actuator cables, boxes, and device connectors	⑥ PROT-M12 SH	1503302	5
Metal M12 sealing cap for unused M12 connectors of sensor/actuator cables, device connectors, and I/O devices in the field	⑦ PROT-M12 FS-M	1430488	10
Stainless steel M12 screw plug for unused M12 sockets of sensor/actuator cables, boxes, and device connectors	⑧ PROT-M12 FB	1555538	5
Closing cap for Pg9/ Pg11, to close unoccupied connections	⑨ Q-PROT 9/11	1670235	10
M16 screw plug with flat nut for oval housing cutouts	⑩ SACC-M16-SEALING PLUG SET	1453368	10

Sealing elements with holding band or fixing chain

All IP67 interfaces can be closed tightly using the screw plugs and sealing caps in the sizes M8, M12 and 7/8". The holding bands are fastened on the cable or the housing and are thus held captive.

The M12 metal protective cap with fixing chain is suitable for all pin versions. It is used in harsh industrial environments or for EMC applications.



Description	Ordering data		
	Type	Order No.	Pcs./Pkt.
Screw plug made from plastic with retaining strap, for sealing unused sockets ① M8 for SAC cables M8 with 3 mm fastening eye M8 with 12 mm fastening eye M12 for SAC cables M12 with 15 mm fastening eye 7/8" for SAC cables	PROT-M 8 MS-PA-CHAIN PROT-M 8 MS-PA-CHAIN-EYE-DM3 PROT-M 8 MS-PA-CHAIN-EYE PROT-M12 MS-PA-CHAIN PROT-M12 MS-PA-CHAIN-EYE-DM14 PROT-MINMS-PA-CHAIN	1430860 1441105 1441095 1430899 1456200 1430925	10 10 10 5 5 10
Plastic sealing cap with holding band, for closing unoccupied connectors ② M8 for SAC cables M8 with 8 mm fastening eye M12 for SAC cables M12 with 12 mm fastening eye M12 with 15 mm fastening eye 7/8" for SAC cables	PROT-M 8 FS-PA-CHAIN PROT-M 8 FS-PA-CHAIN-EYE PROT-M12 FS-PA-CHAIN PROT-M12 FS-PA-CHAIN-EYE-DM12 PROT-M12 FS-PA-CHAIN-EYE-DM14 PROT-MINFS-PA-CHAIN	1430857 1441082 1430873 1456187 1456190 1430912	10 10 5 5 5 10
Sealing cap made of metal with fixing chain and 16 mm fastening eye, for sealing: ③ unused M12 connectors	PROT-M12 FS-M-CHAIN	1430491	10

Accessories

Accessories for M8 distributor boxes with plug-in master cable connection

The torque screwdriver with an M8 nut is the ideal tool for screwing in all M8 connectors with lengthwise knurl.

A replacement connector hood is available for distributors with 4 to 10 slots. The corresponding screwdriver, torque screwdriver, and W24 nut for defined tightening of the pressure nut can be found in the ordering data.

The PROT M8 screw plug, for unused slots, protects the distributor against foreign objects and water. IP65/IP67 protection is therefore achieved.

The slots can be marked using the marking material. Marking can be carried out by hand or using a plotter.



Notes:
Additional marking material and tools can be found in Catalog 3.

Description	Ordering data		
	Type	Order No.	Pcs./Pkt.
Sensor/actuator connector hood , with marking label, for sensor/actuator box with: ①			
4 single-occupancy M8 slots	SACB-C-H180- 4/3-M8	1521229	1
6 single-occupancy M8 slots	SACB-C-H180- 6/3-M8	1521216	1
8 single-occupancy M8 slots	SACB-C-H180- 8/3-M8	1516425	1
Ten single-occupancy M8 slots	SACB-C-H180-10/3-M8	1516412	1
M8 screw plug ② for unused M8 sockets of sensor/actuator cables, boxes, and device connectors	PROT-M8	1682540	5
Labeling material , 10-section ③ - Unprinted - Configurable	ZBF10:UNBEDRUCKT ZBF10 CUS	0809997 0825031	10 1
Torque screwdriver ④ with preset torque of 0.2 Nm and 4 mm hexagonal drive	TSD 02 SAC	1208487	1
Nut ⑤ for assembling M8 connectors with longitudinal knurl and a knurl diameter of 10 mm, for 4 mm hexagonal drive	SAC BIT M8-D10	1208461	1
Nut ⑥ for assembling M8 connectors with longitudinal knurl and a knurl diameter of 12 mm, for 4 mm hexagonal drive	SACC BIT M8-D12	1208474	1
Screwdriver ⑦ Size: PZ2 x 100 mm, length: 205 mm	SZK PZ2 VDE	1206463	10
Torque screwdriver ⑧ with a preset torque of 2.5 Nm and 4 mm hexagonal drive	TSD 25 SAC	1212315	1
Nut ⑨ for secure tightening of the pressure nuts with 24 mm wrench size, for TSD 25 SAC, for 2.5 Nm	SAC BIT HOOD-W 24	1212486	1

Accessories for M8 distributor boxes with M12 and M16 plug-in connection

Corresponding sockets in angled format for distributors with 4 to 10 slots are available in the ordering data. In order to use a master cable in accordance with the specific requirements, sockets for free assembly are available in straight and angled format.

The slots can be marked using the marking material. Marking can be carried out by hand or using a plotter.

The torque screwdriver with matching nuts is the ideal tool for screwing together all M8 connectors with lengthwise knurl.

The PROT M8 screw plug, for unused slots, protects the distributor against foreign objects and water. IP65/IP67 protection is therefore achieved.



Notes:
Additional marking material and tools can be found in Catalog 3.

Description	
M16 socket, angled, with master cable, for sensor/actuator box with:	①
4 slots, cable length: 5 m	
4 slots, cable length: 10 m	
6 slots, cable length: 5 m	
6 slots, cable length: 10 m	
8 slots, cable length: 5 m	
8 slots, cable length: 10 m	
10 slots, cable length: 5 m	
10 slots, cable length: 10 m	
M12 socket, angled, with connected master cable, for sensor/actuator box with:	②
4 slots, cable length: 5 m	
4 slots, cable length: 10 m	
4 slots, cable length: variable	
6 slots, cable length: 5 m	
6 slots, cable length: 10 m	
6 slots, cable length: variable	
M16 socket, 14-pos., straight, freely configurable, with solder connection, for external cable diameter of 6.0 mm ... 8.0 mm	③
M16 socket, 14-pos., angled, freely configurable, with solder connection, for external cable diameter of 6.0 mm ... 8.0 mm	④
M8 screw plug for unused M8 sockets of sensor/actuator cables, boxes, and device connectors	⑤
Labeling material, 10-section - Unprinted - Configurable	⑥
Torque screwdriver with preset torque of 0.2 Nm and 4 mm hexagonal drive	⑦
Nut for assembling M8 connectors with longitudinal knurl and a knurl diameter of 10 mm, for 4 mm hexagonal drive	⑧
Nut for assembling M8 connectors with longitudinal knurl and a knurl diameter of 12 mm, for 4 mm hexagonal drive	⑨

Ordering data			
Type	Order No.	Pcs./Pkt.	
SAC-8P- 5,0-PUR/M16FR	1693681	1	
SAC-8P-10,0-PUR/M16FR	1693694	1	
SAC-10P- 5,0-PUR/M16FR	1693704	1	
SAC-10P-10,0-PUR/M16FR	1693717	1	
SAC-12P- 5,0-PUR/M16FR	1693720	1	
SAC-12P-10,0-PUR/M16FR	1693733	1	
SAC-14P- 5,0-PUR/M16FR	1693746	1	
SAC-14P-10,0-PUR/M16FR	1693759	1	
SAC-6P- 5,0-PURMC/M12FR	1407820	1	
SAC-6P-10,0-PURMC/M12FR	1407821	1	
SAC-6P-M12FR-PURMC/	1520987	1	
SAC-8P- 5,0-PURMC/M12FR	1407822	1	
SAC-8P-10,0-PURMC/M12FR	1407823	1	
SAC-8P-M12FR-PURMC/	1520990	1	
SACC-M16FS-14CON-M	1500554	1	
SACC-M16FR-14CON-M	1500253	1	
PROT-M8	1682540	5	
ZBF10:UNBEDRUCKT	0809997	10	
ZBF10 CUS	0825031	1	
TSD 02 SAC	1208487	1	
SAC BIT M8-D10	1208461	1	
SACC BIT M8-D12	1208474	1	

Ordering example for a socket with variable master cable:

For an M12 socket for 4 slots and a master cable length of 15 m, the ordering data is as follows:

Order No.	Length [m]
1520987	40 m, maximum
	15.0
	Increments: 0.2 ... 3 m = 0.1 m > 3 m = 0.5 m

Accessories

Accessories for M12 distributor boxes with plastic thread and connector hood

The torque screwdriver with M12 nut is the ideal tool for screwing all M12 connectors with longitudinal knurl.

A replacement connector hood is available for the distributors. The corresponding screwdriver, torque screwdriver, and W24 nut for defined tightening of the pressure nut can be found in the ordering data.

The PROT-MS SCO screw plug, for unused slots, protects the distributor against foreign objects and water. IP65/IP67 protection is therefore achieved.

The slots can be marked using the marking material. Marking can be carried out by hand or using a plotter.



Notes:
Additional marking material and tools can be found in Catalog 3.

		Ordering data		
Description	Type	Order No.	Pcs./Pkt.	
Connector hood with integrated connector , for M12 sensor/actuator boxes with plastic thread and plug-in screw connection, for 4, 6 or 8 slots ①				
M12 screw plug fast locking system ② for unused M12 sockets of sensor/actuator cables, boxes, and device connectors	SACB-C-H180-8/16 SCO P	1453229	1	
Labeling material , 5-section ③ - Unprinted, white - Unprinted, yellow - Configurable, white - Configurable, yellow	PROT-MS SCO	1553129	5	
Torque screwdriver ④ with preset torque of 0.4 Nm and 4 mm hexagonal drive	UC-EM (17,5X9) UC-EM (17,5X9) YE UC-EM (17,5X9) CUS UC-EM (17,5X9) YE CUS	0827490 0827494 0828238 0828239	10 10 1 1	
Nut ⑤ for assembling sensor/actuator cables with M12 connector and M12 connectors for assembly, with a knurl diameter of 15 mm, for 4 mm hexagonal drive	TSD 04 SAC	1208429	1	
Nut ⑥ for assembling M12 connectors for assembly, with a knurl diameter of 20 mm, for 4 mm hexagonal drive	SAC BIT M12-D15	1208432	1	
Screwdriver ⑦ Size: PZ2 x 100 mm, length: 205 mm	SACC BIT M12-D20	1208445	1	
Torque screwdriver ⑧ with a preset torque of 2.5 Nm and 4 mm hexagonal drive	SZK PZ2 VDE	1206463	10	
Nut ⑨ for secure tightening of the pressure nuts with 24 mm wrench size, for TSD 25 SAC, for 2.5 Nm	TSD 25 SAC	1212315	1	
Screwdriver , suitable for all screw terminal blocks up to 1.5 mm ² connection cross section, without VDE approval ⑩ Blade: 0,4 x 2,0 x 60 mm, length: 157 mm	SAC BIT HOOD-W 24	1212486	1	
Ferrules , without plastic sleeves, CSA-certified ⑪	SZS 0,4X2,0	1205202	10	
0.5 mm ²	A 0,5 - 6	3200218	1000	
0.75 mm ²	A 0,75-10	3200234	1000	
1.0 mm ²	A 1 -10	3200250	1000	
1.5 mm ²	A 1,5 -10	3200276	1000	

Accessories for M12 distributor boxes with metal thread and pluggable screw connection

The torque screwdriver with M12 nut is the ideal tool for screwing all M12 connectors with longitudinal knurl.

A replacement connector hood is available for the distributors. The corresponding screwdriver, torque screwdriver, and W24 nut for defined tightening of the pressure nut can be found in the ordering data.

The PROT-MS SCO screw plug, for unused slots, protects the distributor against foreign objects and water. IP65/IP67 protection is therefore achieved.

The slots can be marked using the marking material. Marking can be carried out by hand or using a plotter.



Notes:

Additional marking material and tools can be found in Catalog 3.

Description	
Connector hood with integrated connector, for M12 sensor/actuator boxes with metal thread and plug-in screw connection, for 4, 6 or 8 slots	①
M12 screw plug fast locking system	②
for unused M12 sockets of sensor/actuator cables, boxes, and device connectors	
Labeling material , 5-section	③
- Unprinted, white	
- Unprinted, yellow	
- Configurable, white	
- Configurable, yellow	
Torque screwdriver with preset torque of 0.4 Nm and 4 mm hexagonal drive	④
Nut	⑤
for assembling sensor/actuator cables with M12 connector and M12 connectors for assembly, with a knurl diameter of 15 mm, for 4 mm hexagonal drive	
Nut	⑥
for assembling M12 connectors for assembly, with a knurl diameter of 20 mm, for 4 mm hexagonal drive	
Screwdriver	⑦
Size: PZ1 x 80 mm, length: 178 mm	
Torque screwdriver	⑧
with a preset torque of 2.5 Nm and 4 mm hexagonal drive	
Nut	⑨
for secure tightening of the pressure nuts with 24 mm wrench size, for TSD 25 SAC, for 2.5 Nm	

Ordering data

Type	Order No.	Pcs./Pkt.
SACB-C-H180 8/16 SCO	1516713	10
PROT-MS SCO	1553129	5
UC-EM (17,5X9)	0827490	10
UC-EM (17,5X9) YE	0827494	10
UC-EM (17,5X9) CUS	0828238	1
UC-EM (17,5X9) YE CUS	0828239	1
TSD 04 SAC	1208429	1
SAC BIT M12-D15	1208432	1
SACC BIT M12-D20	1208445	1
SZK PZ1 VDE	1206450	10
TSD 25 SAC	1212315	1
SAC BIT HOOD-W 24	1212486	1

Accessories

Accessories for shielded M12 distributor boxes

For the distributors, suitable shielded female connectors are available in angled design with a pre-assembled master cable. Further accessories include straight and angled M23 sockets for free assembly.

The PROT M12 SH screw plug, for unused slots, protects the distributor against foreign objects and water. IP65/IP67 protection is therefore achieved.

The slots can be marked using the marking material. Marking can be carried out by hand or using a plotter.

The torque screwdriver with matching nuts is the ideal tool for screwing together all M12 connectors with lengthwise knurl.



Notes:
Additional marking material and tools can be found in Catalog 3.

		Ordering data		
Description	Type	Order No.	Pcs./Pkt.	
M23 socket, 19-pos., angled, shielded, with connected master cable ①				
Conductor length: 5 m	RCK-TWGM/BL16+3/ 5,0PUR SH	1519529	1	
Conductor length: 10 m	RCK-TWGM/BL16+3/10,0PUR SH	1511828	1	
M23 socket, 19-pos., straight, shielded, freely configurable, with solder connection, for cable Ø: 9.5 mm ... 14.5 mm ②				
	RC/TGGM/KVD/LBL 16+3	1685505	1	
M23 socket, 19-pos., angled, shielded, freely configurable, with solder connection, for cable Ø: 9.5 mm ... 14.5 mm ③				
	RC/TWGM/KVD/LBL 16+3	1685518	1	
Special pipe spanner ④	PLUSCON-RCS	1665062	1	
Auxiliary tool for mounting the M23 connector housing that can be assembled				
M12 screw plug, metal ⑤	PROT-M12 SH	1503302	5	
for unused M12 sockets of shielded sensor/actuator cables, boxes, and device connectors				
Metal M23 sealing cap, for unused M23 connectors ⑥	MSK 1	1665897	10	
- without steel wire	MSK 2	1665907	1	
- with steel wire				
Sealing cap made of plastic, for unoccupied M23 connectors ⑦	KSK 1	1685013	10	
Labeling material ⑧	ZBN 18:UNBEDRUCKT	2809128	10	
- Unprinted, white	UC-TMF 16 YE	0819259	10	
- Unprinted, yellow	ZBN 18 CUS	0825059	1	
- Configurable, white	ZBN 18 YE CUS	0825058	1	
- Configurable, yellow				
Torque screwdriver ⑨	TSD 04 SAC	1208429	1	
with preset torque of 0.4 Nm and 4 mm hexagonal drive				
Nut ⑩	SAC BIT M12-D15	1208432	1	
for assembling sensor/actuator cables with M12 connector and M12 connectors for assembly, with a knurl diameter of 15 mm, for 4 mm hexagonal drive				
Nut ⑪	SACC BIT M12-D20	1208445	1	
for assembling M12 connectors for assembly, with a knurl diameter of 20 mm, for 4 mm hexagonal drive				

Accessories for QUICKON distributor boxes with a connection cross section of 0.14 mm² ... 0.34 mm²

The Q-PROT 9/11 sealing plug, for unused slots, protects the distributor against foreign objects and water. IP65/IP67 protection is therefore achieved.

A torque screwdriver with W13 nut is available for the fast connection pressure nut. The handling of the tools is self-explanatory.

A replacement connector hood is available for the distributors. The corresponding screwdriver, torque screwdriver, and W24 nut for defined tightening of the pressure nut can be found in the ordering data.

The slots can be marked using the marking material. Marking can be carried out by hand or using a plotter.

The QUICKON replacement set, consisting of splice ring, pressure nut, and cable seal.

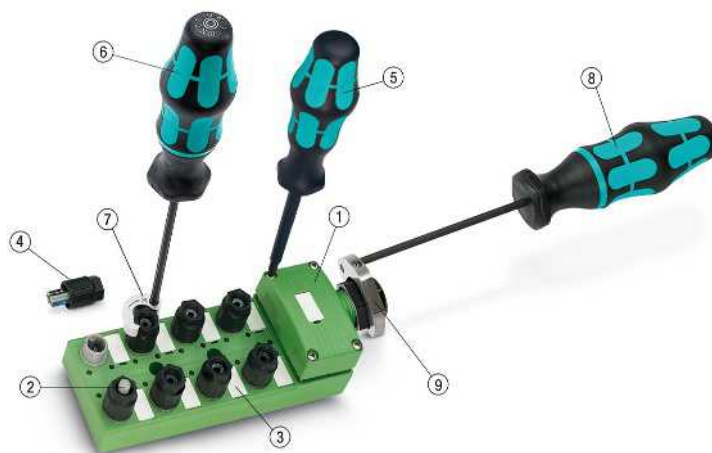

Notes:

Additional marking material and tools can be found in Catalog 3.

Description	
Connector hood with an integrated connector, for sensor/actuator boxes with QUICKON fast connection technology and plug-in screw connection, for 4, 6 or 8 slots	①
Closing cap for Pg9/ Pg11, to close unoccupied connections	②
Labeling material , 5-section - Unprinted, white - Unprinted, yellow - Configurable, white - Configurable, yellow	③
QUICKON set for replacement purposes, consisting of splice ring, pressure nut and conductor seal	④
Screwdriver Size: PZ1 x 80 mm, length: 178 mm	⑤
Torque screwdriver with a preset torque of 2.0 Nm and 4 mm hexagonal drive	⑥
Nut for secure tightening of the pressure nuts with 13 mm wrench size, for TSD 20 SAC, for 0.8 Nm, and 2.0 Nm	⑦
Torque screwdriver with a preset torque of 2.5 Nm and 4 mm hexagonal drive	⑧
Nut for secure tightening of the pressure nuts with 24 mm wrench size, for TSD 25 SAC, for 2.5 Nm	⑨

Ordering data

Type	Order No.	Pcs./Pkt.
SACB-C-H180 8/4 QO-0,34	1560235	1
Q-PROT 9/11	1670235	10
UC-EM (17,5X9)	0827490	10
UC-EM (17,5X9) YE	0827494	10
UC-EM (17,5X9) CUS	0828238	1
UC-EM (17,5X9) YE CUS	0828239	1
QO-SET	1548626	20
SZK PZ1 VDE	1206450	10
TSD 20 SAC	1212020	1
SAC BIT QUICKON-W13	1212033	1
TSD 25 SAC	1212315	1
SAC BIT HOOD-W 24	1212486	1

Sensor/actuator cabling

Accessories

Accessories for QUICKON distributor boxes with a connection cross section of 0.34 mm² ... 0.75 mm²

The distributors are supplied as standard with a black rubber seal for an external cable diameter of 6.5 mm to 9.5 mm. Further rubber seals for master cables from 4.0 mm to 6.5 mm (yellow seal) or 9.0 mm to 13.0 mm (red seal) are available in the ordering data. The torque screwdriver with W24 nut is suitable for the defined tightening of the pressure nut.

The QUICKON replacement set consists of pressure nut, cap, cable seal, and splice ring.

The socket wrench is used to conveniently loosen and fasten the QUICKON pressure nut.

The Q-PROT 9/11 sealing plug, for unused slots, protects the distributor against foreign objects and water. IP65/IP67 protection is therefore achieved.

The slots can be marked using the marking material. Marking can be carried out by hand or using a plotter.

Notes:
Additional marking material and tools can be found in Catalog 3.















		Ordering data		
Description		Type	Order No.	Pcs./Pkt.
Rubber seal for Pg13.5 screw connection	①			
for cable Ø: 4.0 mm ... 6.5 mm		SACB-D PG 13,5 (4,0-6,5) YE	1680377	10
Rubber seal for Pg13.5 screw connection	②			
for cable Ø: 6.5 mm ... 9.5 mm		SACB-D PG 13,5 (6,5-9,5) BK	1680380	10
Rubber seal for Pg13.5 screw connection	③			
for cable Ø: 9.0 mm ... 13.0 mm		SACB-D PG 13,5 (9,0-13,0) RD	1680393	10
Closing cap for Pg9/ Pg11, to close unoccupied connections	④	Q-PROT 9/11	1670235	10
Labeling material	⑤			
- Unprinted, white		ZBN 18:UNBEDRUCKT	2809128	10
- Unprinted, yellow		UC-TMF 16 YE	0819259	10
- Configurable, white		ZBN 18 CUS	0825059	1
- Configurable, yellow		ZBN 18 YE CUS	0825058	1
QUICKON set for replacement purposes, consisting of pressure nut, cap, conductor seal and splice ring	⑥	Q SET-11/4 COD1 SACB-Q	1670743	25
Screwdriver Size: PZ1 x 80 mm, length: 178 mm	⑦	SZK PZ1 VDE	1206450	10
Slotted socket wrench for QUICKON nuts and panel feed-throughs 1.5 mm ² , 5-pos. / 2.5 mm ² , 4-pos. / wrench size 22 mm	⑧	QSS 22	1670206	1
Torque screwdriver with a preset torque of 2.5 Nm and 4 mm hexagonal drive	⑨	TSD 25 SAC	1212315	1
Nut for secure tightening of the pressure nuts with 24 mm wrench size, for TSD 25 SAC, for 2.5 Nm	⑩	SAC BIT HOOD-W 24	1212486	1

Sensor/actuator cabling

Sensor/actuator cabling – cable range

Symbol key

	With UL style		Suitable for drag chain applications		Resistant to welding sparks
	UV-resistant		Flame-retardant		High temperature resistance
	Good oil resistance		Good resistance to chemicals		Suitable for torsional stress
	Halogen-free		Suitable for the food industry		Suitable for railway applications





PUR, halogen-free – PHOENIX CONTACT standard



Permanently flexible control cables designed for use in drag chains, revolving/swivel tables, and as machine control cables for extreme operating conditions. The control cables are suitable for bending cycle loads with long-term durability. The special PUR outer sheath offers excellent resistance to oils in accordance with DIN EN 60811-2-1, lubricants, cooling agents, and other aggressive substances.

Additional features of the control cables: halogen- and PVC-free, free of silicone and substances that would hinder coating with paint or varnish, resistant to hydrolysis, and flame-retardant in accordance with UL-FT2.

Outer sheath material	PUR
Minimum bending cycles	4 million
Minimum bending radius	10 x D
Traverse path	10 m
Acceleration	10 m/s²
Speed	3 m/s
Tested at	+20°C ... +25°C

Type	Number of positions	Application	Structure	Cross section	Wire colors	Wire insulation	Temperature range	Page
PUR Black	3-pos.	M8	3 x 0.25 mm ² (32 x 0.1 mm)		Brown, blue, black	PP	Moving: -25°C ... +80°C Fixed: -40°C ... +80°C	186 248 250 302
		M8 Shielded	3 x 0.25 mm ² (32 x 0.1 mm) Shielding: copper braid		Brown, blue, black	PP	Moving: -25°C ... +80°C Fixed: -40°C ... +80°C	193 302
		M12	3 x 0.34 mm ² (42 x 0.1 mm)		Brown, blue, black	PP	Moving: -25°C ... +80°C Fixed: -40°C ... +80°C	186 250 302
		M12 Shielded	3 x 0.34 mm ² (42 x 0.1 mm) Shielding: copper braid		Brown, blue, black	PP	Moving: -25°C ... +80°C Fixed: -40°C ... +80°C	193
		Valve connectors	3 x 0.5 mm ² (28 x 0.15 mm)		Black 1, black 2, green-yellow	PP	Moving: -15°C ... +80°C Fixed: -40°C ... +80°C	230 to 238 304

Type	Number of positions	Application	Structure	Cross section	Wire colors	Wire insulation	Temperature range	Page
PUR Black	4-pos.	M8	4 x 0.25 mm ² (32 x 0.1 mm)		Brown, white, blue, black	PP	Moving: -25°C ... +80°C Fixed: -40°C ... +80°C	186 194 302
		M8 Shielded	4 x 0.25 mm ² (32 x 0.1 mm) Shielding: copper braid		Brown, white, blue, black	PP	Moving: -25°C ... +80°C Fixed: -40°C ... +80°C	199 302
		M12	4 x 0.34 mm ² (42 x 0.1 mm)		Brown, white, blue, black	PP	Moving: -25°C ... +80°C Fixed: -40°C ... +80°C	194 249 302
		M12 Shielded	4 x 0.34 mm ² (42 x 0.1 mm) Shielding: copper braid		Brown, white, blue, black	PP	Moving: -25°C ... +80°C Fixed: -40°C ... +80°C	199 302
		M12 POWER	4 x 1.5 mm ² (84 x 0.15 mm)		Brown, white, blue, black	PP	Moving: -30°C ... +90°C Fixed: -40°C ... +90°C	290
		M12 POWER	4 x 1.5 mm ² (84 x 0.15 mm)		Black 1, black 2, black 3, green-yellow	PP	Moving: -30°C ... +90°C Fixed: -40°C ... +90°C	289
		M12 POWER Shielded	4 x 1.5 mm ² (78 x 0.15 mm) Shielding: copper braid		Brown, white, blue, black	PP	Moving: -30°C ... +90°C Fixed: -40°C ... +90°C	290
		M12 POWER	4 x 2.5 mm ² (141 x 0.15 mm)		Brown, white, blue, black	PP	Moving: -30°C ... +80°C Fixed: -50°C ... +80°C	296
		Valve connectors	4 x 0.5 mm ² (28 x 0.15 mm)		Black 1, black 2, black 3, green-yellow	PP	Moving: -20°C ... +80°C Fixed: -40°C ... +80°C	230 to 238
	5-pos.	M12	5 x 0.34 mm ² (42 x 0.1 mm)		Brown, white, blue, black, green-yellow	PP	Moving: -25°C ... +80°C Fixed: -40°C ... +80°C	201 302
		M12 Shielded	5 x 0.34 mm ² (42 x 0.1 mm) Shielding: copper braid		Brown, white, blue, black, gray	PP	Moving: -25°C ... +80°C Fixed: -40°C ... +80°C	204 302
		Valve connectors	5 x 0.5 mm ² (28 x 0.15 mm)		Black 1, black 2, black 3, black 4, green-yellow	PP	Moving: -15°C ... +80°C Fixed: -40°C ... +80°C	242 304

Sensor/actuator cabling

Sensor/actuator cabling – cable range

Type	Number of positions	Use	Structure	Cross section	Wire colors	Wire insulation	Temperature range	Page
PUR Black	5-pos.	M12 Power	5 x 2.5 mm ² (141 x 0.15 mm)		Black 1, black 2, black 3, black 4, green-yellow	PP	Mobile: -20°C ... +80°C Fixed: -40°C ... +80°C	292
		M12 Power Shielded	5 x 2.5 mm ² (141 x 0.15 mm)		Black 1, black 2, black 3, black 4, green-yellow	PP	Mobile: -20°C ... +80°C Fixed: -40°C ... +80°C	292
	6-pos.	M8	6 x 0.25 mm ² (32 x 0.1 mm)		Brown, white, blue, black, gray, pink	PP	Mobile: -25°C ... +80°C Fixed: -40°C ... +80°C	205 302
		M8 Shielded	6 x 0.14 mm ² (18 x 0.1 mm) Shielding: copper braid		Brown, white, blue, black, gray, pink	PP	Mobile: -25°C ... +80°C Fixed: -40°C ... +80°C	206 302
		M12 Power	6 x 1.5 mm ² (78 x 0.15 mm)		Black 1, black 2, black 3, black 4, black 5, green-yellow	PP	Mobile: -25°C ... +80°C Fixed: -40°C ... +80°C	See: phoenix contact.net/ products
		M12 Power Shielded	6 x 1.5 mm ² (78 x 0.15 mm)		Black 1, black 2, black 3, black 4, black 5, green-yellow	PP	Mobile: -25°C ... +80°C Fixed: -40°C ... +80°C	See: phoenix contact.net/ products
	8-pos.	M8	8 x 0.14 mm ² (18 x 0.1 mm)		In accordance with DIN 47100	PP	Mobile: -25°C ... +80°C Fixed: -40°C ... +80°C	207
		M8 Shielded	8 x 0.14 mm ² (18 x 0.1 mm) Shielding: copper braid		In accordance with DIN 47100	PP	Mobile: -25°C ... +80°C Fixed: -40°C ... +80°C	210
		M12	8 x 0.25 mm ² (32 x 0.1 mm)		In accordance with DIN 47100	PP	Mobile: -25°C ... +80°C Fixed: -40°C ... +80°C	208 302
		M12 Shielded	8 x 0.25 mm ² (32 x 0.1 mm) Shielding: copper braid		In accordance with DIN 47100	PP	Mobile: -25°C ... +80°C Fixed: -40°C ... +80°C	211 302
	12-pos.	M12	12 x 0.14 mm ² (18 x 0.1 mm)		In accordance with DIN 47100	PP	Mobile: -20°C ... +80°C Fixed: -40°C ... +80°C	212
	17-pos.	M12	17 x 0.14 mm ² (18 x 0.1 mm)		In accordance with DIN 47100	PP	Mobile: -20°C ... +80°C Fixed: -40°C ... +80°C	212

Type	Number of positions	Use	Structure	Cross section	Wire colors	Wire insulation	Temperature range	Page
PUR Orange	4-pos.	M12 Power Shielded	4 x 1.5 mm ² (78 x 0.15 mm) Shielding: copper braid		Black 1, black 2, black 3, green-yellow	PP	Mobile: -30°C ... +90°C Fixed: -40°C ... +90°C	289
115 Black	5-pos.	M8	5 x 0.25 mm ² (32 x 0.1 mm)		Brown, white, blue, black, gray	PP	Mobile: -25°C ... +80°C Fixed: -40°C ... +80°C	200
		M12	5 x 0.34 mm ² (42 x 0.1 mm)		Brown, white, blue, black, gray	PP	Mobile: -25°C ... +80°C Fixed: -40°C ... +80°C	201
121 Black	3-pos.	Valve connectors	3 x 1.0 mm ² (32 x 0.20 mm)		Black 1, black 2, green-yellow	PP	Mobile: -20°C ... +80°C Fixed: -40°C ... +80°C	230 232
240 Yellow	3-pos.	Valve connectors	3 x 0.5 mm ² (28 x 0.15 mm)		Black 1, black 2, green-yellow	PP	Mobile: -15°C ... +80°C Fixed: -40°C ... +80°C	230 to 238
	4-pos.	M12	4 x 0.34 mm ² (42 x 0.1 mm)		Brown, white, blue, black	PP	Mobile: -25°C ... +80°C Fixed: -40°C ... +80°C	194
	5-pos.	Valve connectors	5 x 0.5 mm ² (28 x 0.15 mm)		Black 1, black 2, black 3, black 4, green-yellow	PP	Mobile: -15°C ... +80°C Fixed: -40°C ... +80°C	230 to 238
280 Gray	3-pos.	M8	3 x 0.25 mm ² (32 x 0.1 mm)		Brown, blue, black	PP	Mobile: -25°C ... +80°C Fixed: -40°C ... +80°C	186 188 250
		M12	3 x 0.34 mm ² (42 x 0.1 mm)		Brown, blue, black	PP	Mobile: -25°C ... +80°C Fixed: -40°C ... +80°C	188 250
	4-pos.	Valve connectors	3 x 0.5 mm ² (28 x 0.15 mm)		Black 1, black 2, green-yellow	PP	Mobile: -15°C ... +80°C Fixed: -40°C ... +80°C	230 to 238
		M12	4 x 0.34 mm ² (42 x 0.1 mm)		Brown, white, blue, black	PP	Mobile: -25°C ... +80°C Fixed: -40°C ... +80°C	194

Sensor/actuator cabling

Sensor/actuator cabling – cable range

Type	Number of positions	Application	Structure	Cross section	Wire colors	Wire insulation	Temperature range	Page
280 Gray	5-pos.	Valve connectors	5 x 0.5 mm ² (28 x 0.15 mm)		Black 1, black 2, black 3, black 4, green-yellow	PP	Moving: -15°C ... +80°C Fixed: -40°C ... +80°C	242
		M12 POWER	5 x 2.5 mm ² (141 x 0.15 mm)		Brown, white, blue, black, gray	PP	Moving: -30°C ... +80°C Fixed: -50°C ... +80°C	294
	8-pos.	M12 Shielded	8 x 0.25 mm ² (32 x 0.1 mm) Shielding: copper braid		In accordance with DIN 47100	PP	Moving: -25°C ... +80°C Fixed: -40°C ... +80°C	211
290 Gray	5-pos.	M12 POWER	5 x 1.5 mm ² (78 x 0.15 mm)		Brown, white, blue, black, gray	PP	Moving: -30°C ... +80°C Fixed: -50°C ... +80°C	294

PUR/PVC (also applies to type PUR for M5 connectors)



The cables are designed for robust use in machine tools, assembly/production lines, as well as production involving metal cutting. The cables are free of silicone and substances that would hinder coating with paint or varnish and have a high resistance to abrasion. The outer sheath also offers excellent resistance to chemicals and oil in accordance with DIN EN 60811-2-1 and

is flame-retardant in accordance with DIN EN 50265. The outer sheath is manufactured using the coextrusion process.

Outer sheath material	PUR
Inner sheath material	PVC
Minimum bending cycles	2 million
Minimum bending radius	10 x D
Traversal path	5 m
For type 35 T	10 m
Acceleration	5 m/s²
For type 35 T	10 m/s²
Speed	3 m/s
Tested at	+20°C ... +25°C

Type	Number of positions	Application	Structure	Cross section	Wire colors	Wire insulation	Temperature range	Page
35T Black Twisted pair	12-pos.	M12 Shielded	6 x 2 x 0.14 mm ² (18 x 0.1 mm) Shielding: copper braid		In accordance with DIN 47100	PVC	Moving: -5°C ... +80°C Fixed: -40°C ... +80°C	214
	17-pos.	M12 Shielded	7 x 2 x 0.14 mm ² 1 x 3 x 0.14 mm ² (18 x 0.1 mm) Shielding: copper braid		In accordance with DIN 47100	PVC	Moving: -5°C ... +80°C Fixed: -40°C ... +80°C	215
PUR Black For M5	3-pos.	M5	3 x 0.14 mm ² (18 x 0.1 mm)		Brown, blue, black	PVC	Moving: -5°C ... +80°C Fixed: -15°C ... +80°C	See: phoenix contact.net/ products
	4-pos.	M5	4 x 0.14 mm ² (18 x 0.1 mm)		Brown, white, blue, black	PVC	Moving: -5°C ... +80°C Fixed: -15°C ... +80°C	See: phoenix contact.net/ products

PUR cross-linking through irradiation, resistant to welding sparks

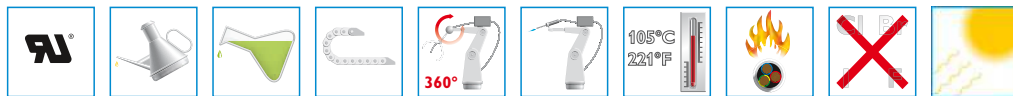

Due to the cross-linking of the PUR outer sheath through irradiation, the properties typical of PUR, e.g., resistance to temperature, UV, and welding sparks, are greatly improved. The cables are designed for robust use in the field of robot technology. Thanks to their very high durability, the cables are particularly suitable for welding robots.

Flame-retardant in accordance with DIN VDE 0472, Part 804, test type B.

Outer sheath material PUR irradiated

Minimum bending cycles	5 million
Minimum bending radius	10 x D
Traverse path	10 m
Acceleration	10 m/s²
Speed	3 m/s
Torsion	±360°
Tested at	+20°C ... +25°C

Type	Number of positions	Application	Structure	Cross section	Wire colors	Wire insulation	Temperature range	Page
150 Orange	3-pos.	M12	3 x 0.34 mm ² (42 x 0.1 mm)		Brown, blue, black	Halogen-free polyester-based plastic	Moving: -40°C ... +105°C Fixed: -50°C ... +105°C	188 250
		Valve connectors	3 x 0.5 mm ² (28 x 0.15 mm)		Black 1, black 2, green-yellow	Halogen-free polyester-based plastic	Moving: -40°C ... +105°C Fixed: -50°C ... +105°C	230 to 238
	4-pos.	M12	4 x 0.34 mm ² (42 x 0.1 mm)		Brown, white, blue, black	Halogen-free polyester-based plastic	Moving: -40°C ... +105°C Fixed: -50°C ... +105°C	194
		M12	4 x 0.34 mm ² + 1 x 0.5 mm ² (42 x 0.1 mm, 24 x 0.15 mm)		Brown, white, blue, black, green-yellow	Halogen-free polyester-based plastic	Moving: -40°C ... +105°C Fixed: -50°C ... +105°C	201
		Valve connectors	5 x 0.5 mm ² (28 x 0.15 mm)		Black 1, black 2, black 3, black 4, green-yellow	Halogen-free polyester-based plastic	Moving: -40°C ... +105°C Fixed: -50°C ... +105°C	242
160 Yellow	4-pos.	M12	4 x 0.34 mm ² (42 x 0.1 mm)		Brown, white, blue, black	Halogen-free polyester-based plastic	Moving: -40°C ... +105°C Fixed: -50°C ... +105°C	194

TPE-U highly flexible



Permanently flexible control cables excellent for use in drag chains and industrial robots. The cables can be used wherever extreme bending and torsional stress are present at the same time, and considerably longer durability has to be achieved. The control cables are resistant to welding sparks and are thus the only type suitable for use in resistance welding processes. The use of new materials eliminates irradiation cross-linking, which makes the cables easier to recycle. The cables thus meet the requirements of DIN EN ISO 14001.

Further features of the control cables: halogen and PVC-free, flame-retardant in accordance with UL-FT1, VW1 and 1581 §1061, very good resistance to oils in accordance with VDE 0250 Part 407 and chemicals, lubricants, and coolants as well as other aggressive substances.

Due to the very robust outer sheath, the cable sheath is only removed in 5 cm increments.

Outer sheath material	TPE-U
Minimum bending cycles	10 million
Minimum bending radius	
Fixed	5 x D
Moving	7.5 x D
Traversal path	5 m
Acceleration	20 m/s²
Speed	3.33 m/s
Torsion angle	±360°
Min. torsion cycles	13 million
Tested at	+20°C ... +25°C

Type	Number of positions	Application	Structure	Cross section	Wire colors	Wire insulation	Temperature range	Page
800 Gray	3-pos.	M8	3 x 0.25 mm ² (32 x 0.1 mm)		Brown, blue, black	Polyester	Moving: -30°C ... +90°C Fixed: -40°C ... +90°C 120°C ... 3,000 h	186 188 250
		M12	3 x 0.34 mm ² (42 x 0.1 mm)		Brown, blue, black	Polyester	Moving: -30°C ... +90°C Fixed: -40°C ... +90°C 120°C ... 3,000 h	188 250 192
	4-pos.	M8	4 x 0.25 mm ² (32 x 0.1 mm)		Brown, white, blue, black	Polyester	Moving: -30°C ... +90°C Fixed: -40°C ... +90°C 120°C ... 3,000 h	186 194
		M12	4 x 0.34 mm ² (42 x 0.1 mm)		Brown, white, blue, black	Polyester	Moving: -30°C ... +90°C Fixed: -40°C ... +90°C 120°C ... 3,000 h	194 198
	5-pos.	M12	5 x 0.34 mm ² (42 x 0.1 mm)		Brown, white, blue, black, gray	Polyester	Moving: -30°C ... +90°C Fixed: -40°C ... +90°C 120°C ... 3,000 h	201
	8-pos.	M12	8 x 0.25 mm ² (32 x 0.1 mm)		In accordance with DIN 47100	Polyester	Moving: -30°C ... +90°C Fixed: -40°C ... +90°C 120°C ... 3,000 h	208
802 Gray	5-pos.	M12	5 x 0.34 mm ² (42 x 0.1 mm)		Brown, white, blue, black, green-yellow	Polyester	Moving: -30°C ... +90°C Fixed: -40°C ... +90°C 120°C ... 3,000 h	203

PVC – 80°C and 105°C



This very reasonably priced high-quality cable is suitable for use under dry conditions and average mechanical strain associated with machine tools, packaging machines, and assembly/production lines. The cable offers a certain degree of resistance to chemicals and oil and is less susceptible to wear. Flame-retardant to VW-1 in accordance with UL 758.

VW-1 is the toughest flame test for single cables.

Outer sheath material PVC
Minimum bending radius 10 x D

Type	Number of positions	Application	Structure	Cross section	Wire colors	Wire insulation	Temperature range	Page
PVC Black	3-pos.	M8	3 x 0.25 mm ² (14 x 0.15 mm)		Brown, blue, black	PVC	Moving: -5°C ... +80°C Fixed: -25°C ... +80°C	188 250 302
		M12	3 x 0.34 mm ² (19 x 0.15 mm)		Brown, blue, black	PVC	Moving: -5°C ... +80°C Fixed: -25°C ... +80°C	188 250 302
		M12 Shielded	3 x 0.34 mm ² (42 x 0.1 mm) Shielding: copper braid		Brown, blue, black	PVC	Moving: -5°C ... +80°C Fixed: -25°C ... +80°C	193 302
		Valve connectors	3 x 0.5 mm ² (16 x 0.2 mm)		Black 1, black 2, green-yellow	PVC	Moving: -5°C ... +80°C Fixed: -40°C ... +80°C	230 to 238
	4-pos.	M8	4 x 0.25 mm ² (14 x 0.15 mm)		Brown, white, blue, black	PVC	Moving: -5°C ... +80°C Fixed: -25°C ... +80°C	194 302
		M12	4 x 0.34 mm ² (19 x 0.15 mm)		Brown, white, blue, black	PVC	Moving: -5°C ... +80°C Fixed: -25°C ... +80°C	194 302
		M12 Shielded	4 x 0.34 mm ² (42 x 0.1 mm) Shielding: copper braid		Brown, white, blue, black	PVC	Moving: -5°C ... +80°C Fixed: -25°C ... +80°C	199 302
		Valve connectors	4 x 0.5 mm ² (16 x 0.2 mm)		Black 1, black 2, black 3, green-yellow	PVC	Moving: -5°C ... +80°C Fixed: -40°C ... +80°C	242
		M12 POWER	4 x 2.5 mm ² (141 x 0.15 mm)		Brown, white, blue, black	PVC	Moving: -20°C ... +80°C Fixed: -40°C ... +80°C	297

Sensor/actuator cabling

Sensor/actuator cabling – cable range

Type	Number of positions	Application	Structure	Cross section	Wire colors	Wire insulation	Temperature range	Page	
PVC Black	5-pos.	M12	5 x 0.34 mm ² (19 x 0.15 mm)		Brown, white, blue, black, green-yellow	PVC	Moving: -5°C ... +80°C Fixed: -25° ... +80°C	201 302	
		M12 Shielded	5 x 0.34 mm ² (42 x 0.1 mm) Shielding: copper braid		Brown, white, blue, black, green-yellow	PVC	Moving: -5°C ... +80°C Fixed: -25° ... +80°C	204 302	
		Valve connectors	5 x 0.5 mm ² (28 x 0.15 mm)		Black 1, black 2, black 3, black 4, green-yellow	PVC	Moving: -5°C ... +80°C Fixed: -40° ... +80°C	230 to 238	
		M12 POWER	5 x 2.5 mm ² (141 x 0.15 mm)		Black 1, black 2, black 3, black 4, green-yellow	PVC	Moving: -20°C ... +80°C Fixed: -40° ... +80°C	293	
		M12 POWER Shielded	5 x 2.5 mm ² (141 x 0.15 mm)		Black 1, black 2, black 3, black 4, green-yellow	PVC	Moving: -20°C ... +80°C Fixed: -40° ... +80°C	293	
	6-pos.	M12 POWER	6 x 1.5 mm ² (78 x 0.15 mm)		Black 1, black 2, black 3, black 4, black 5, green-yellow	PVC	Moving: -20°C ... +80°C Fixed: -40° ... +80°C	See: phoenix contact.net/ products	
		M12 POWER Shielded	6 x 1.5 mm ² (78 x 0.15 mm)		Black 1, black 2, black 3, black 4, black 5, green-yellow	PVC	Moving: -20°C ... +80°C Fixed: -40° ... +80°C	See: phoenix contact.net/ products	
	8-pos.	M12	8 x 0.25 mm ² (14 x 0.15 mm)		White, brown, green, yellow, gray, pink, blue, red	PVC	Moving: -5°C ... +80°C Fixed: -25° ... +80°C	208 302	
		M12 Shielded	8 x 0.25 mm ² (32 x 0.1 mm) Shielding: copper braid and flexible filler lead		White, brown, green, yellow, gray, pink, blue, red	PVC	Moving: -5°C ... +105°C Fixed: -25° ... +105°C	211 302	
	12-pos.	M12	12 x 0.14 mm ² (18 x 0.1 mm)		In accordance with DIN 47100	PVC	Moving: -5°C ... +90°C Fixed: -40° ... +90°C	213 302	
	17-pos.	M12	17 x 0.14 mm ² (18 x 0.1 mm)		In accordance with DIN 47100	PVC	Moving: -5°C ... +90°C Fixed: -25° ... +90°C	213 302	
	110 Black	4-pos.	M12 POWER	4 x 1.5 mm ² (78 x 0.15 mm)		Brown, white, blue, black	PVC	Moving: -20°C ... +80°C Fixed: -40° ... +80°C	291 297

Type	Number of positions	Application	Structure	Cross section	Wire colors	Wire insulation	Temperature range	Page	
500 Gray	3-pos.	M8	3 x 0.25 mm ² (14 x 0.15 mm)		Brown, blue, black	PVC	Moving: -5°C ... +80°C Fixed: -25° ... +80°C	188 250	
		M12	3 x 0.34 mm ² (19 x 0.15 mm)		Brown, blue, black	PVC	Moving: -5°C ... +80°C Fixed: -25° ... +80°C	188 250	
		M12 Shielded	3 x 0.34 mm ² (42 x 0.1 mm) Shielding: copper braid		Brown, blue, black	PVC	Moving: -5°C ... +80°C Fixed: -25° ... +80°C	193	
	4-pos.	M8	4 x 0.25 mm ² (14 x 0.15 mm)		Brown, white, blue, black	PVC	Moving: -5°C ... +80°C Fixed: -25° ... +80°C	194	
		M12	4 x 0.34 mm ² (19 x 0.15 mm)		Brown, white, blue, black	PVC	Moving: -5°C ... +80°C Fixed: -25° ... +80°C	194	
		M12 Shielded	4 x 0.34 mm ² (42 x 0.1 mm) Shielding: copper braid		Brown, white, blue, black	PVC	Moving: -5°C ... +80°C Fixed: -25° ... +80°C	199	
	5-pos.	M12	5 x 0.34 mm ² (19 x 0.15 mm)		Brown, white, blue, black, green-yellow	PVC	Moving: -5°C ... +80°C Fixed: -25° ... +80°C	201	
		M12 Shielded	5 x 0.34 mm ² (42 x 0.1 mm) Shielding: copper braid		Brown, white, blue, black, gray	PVC	Moving: -5°C ... +80°C Fixed: -25° ... +80°C	204	
		M12 POWER	5 x 2.5 mm ² (141 x 0.15 mm)		Brown, white, blue, black, gray	PVC	Moving: -20°C ... +80°C Fixed: -40° ... +80°C	295	
	8-pos.	M12	8 x 0.25 mm ² (14 x 0.15 mm)		White, brown, green, yellow, gray, pink, blue, red	PVC	Moving: -5°C ... +80°C Fixed: -25° ... +80°C	208	
	510 Gray	5-pos.	M12 POWER	5 x 1.5 mm ² (78 x 0.15 mm)		Brown, white, blue, black, gray	PVC	Moving: -20°C ... +80°C Fixed: -40° ... +80°C	295
	515 Black	5-pos.	M12	5 x 0.34 mm ² (42 x 0.1 mm)		Brown, white, blue, black, gray	PVC	Moving: -5°C ... +80°C Fixed: -40° ... +80°C	201

Sensor/actuator cabling

Sensor/actuator cabling – cable range

Type	Number of positions	Use	Structure	Cross section	Wire colors	Wire insulation	Temperature range	Page
534 Black	3-pos.	Valve connectors	3 x 0.75 mm ² (24 x 0.2 mm)		Black 1, black 2, green-yellow	PVC	Mobile: -5°C ... +80°C Fixed: -40°C ... +80°C	230 to 238 304
	4-pos.	Valve connectors	4 x 0.75 mm ² (24 x 0.2 mm)		Black 1, black 2, black 3, green-yellow	PVC	Mobile: -5°C ... +80°C Fixed: -40°C ... +80°C	242
	5-pos.	Valve connectors	5 x 0.75 mm ² (24 x 0.2 mm)		Black 1, black 2, black 3, black 4, green-yellow	PVC	Mobile: -5°C ... +80°C Fixed: -40°C ... +80°C	242 304
540 Yellow	3-pos.	M12	3 x 0.34 mm ² (42 x 0.1 mm)		Brown, blue, black	PVC	Mobile: -5°C ... +80°C Fixed: -25°C ... +80°C	188 250
	4-pos.	M12	4 x 0.34 mm ² (42 x 0.1 mm)		Brown, white, blue, black	PVC	Mobile: -5°C ... +80°C Fixed: -25°C ... +80°C	194
	5-pos.	M12	5 x 0.34 mm ² (42 x 0.1 mm)		Brown, white, blue, black, gray	PVC	Mobile: -5°C ... +80°C Fixed: -25°C ... +80°C	201
542 Yellow	3-pos.	M12	3 x 0.34 mm ² (42 x 0.1 mm)		Brown, blue, black	PVC	Mobile: -5°C ... +105°C Fixed: -25°C ... +105°C	188 250
	4-pos.	M12	4 x 0.34 mm ² (42 x 0.1 mm)		Brown, white, blue, black	PVC	Mobile: -5°C ... +105°C Fixed: -25°C ... +105°C	194
	5-pos.	M12	5 x 0.34 mm ² (42 x 0.1 mm)		Brown, white, blue, black, gray	PVC	Mobile: -5°C ... +105°C Fixed: -25°C ... +105°C	201

Sensor/actuator cabling

Sensor/actuator boxes – cable range

PUR/PVC (for sensor/actuator boxes)









The cables are designed for robust use in machine tools, assembly/production lines, as well as production involving metal cutting. The cables are free of silicone and substances that would hinder coating with paint or varnish and have a high resistance to abrasion. The outer sheath also offers excellent resistance to chemicals and oil in accordance with VDE 0472 Part 803, is flame-retardant in accordance with DIN EN 50265, and is resistant to hydrolysis. The outer sheath is

manufactured using the coextrusion process.

Outer sheath material PUR
Inner sheath material PVC

Minimum bending cycles 1.5 ... 2 million
Minimum bending radius 10 x D
Traverse path 2 m
Speed 2 m/s
Tested at +20°C ... +25°C

Type	Number of positions	Application	Structure	Cross section	Wire colors	Wire insulation	Temperature range	Page
PUR/PVC Black	3-pos., single- occupancy	M8 and QUICKON up to 0.34 mm ² 4 slots	4 x 0.34 mm ² 2 x 0.75 mm ²		White, green, yellow, gray, brown, blue	PVC	Moving: -5°C ... +80°C Fixed: -40°C ... +90°C	260 266 305
		M8 and QUICKON up to 0.34 mm ² 6 slots	6 x 0.34 mm ² 2 x 0.75 mm ²		White, green, yellow, gray, pink, red, brown, blue	PVC	Moving: -5°C ... +80°C Fixed: -40°C ... +90°C	260 266 305
		M8 and QUICKON up to 0.34 mm ² 8 slots	8 x 0.34 mm ² 2 x 0.75 mm ²		White, green, yellow, gray, pink, red, black, violet, brown, blue	PVC	Moving: -5°C ... +80°C Fixed: -40°C ... +90°C	260 266 305
		M8 10 slots	10 x 0.34 mm ² 2 x 0.75 mm ²		White, green, yellow, gray, pink, red, black, violet, white-pink, pink-brown, brown, blue	PVC	Moving: -5°C ... +80°C Fixed: -40°C ... +90°C	260 305
	4-pos., double- occupancy	QUICKON up to 0.34 mm ² 4 slots	8 x 0.34 mm ² 2 x 0.75 mm ²		White, green, yellow, gray, gray-pink, red-blue, white-green, brown-green, brown, blue	PVC	Moving: -5°C ... +80°C Fixed: -40°C ... +90°C	266
		M8 and QUICKON up to 0.34 mm ² 8 slots	16 x 0.34 mm ² 2 x 0.75 mm ²		White, green, yellow, gray, pink, red, black, violet, gray-pink, red-blue, white-green, brown-green, white-yellow, yellow-brown, white-gray, gray-brown, brown, blue	PVC	Moving: -5°C ... +80°C Fixed: -40°C ... +90°C	260 266 305

Type	Number of positions	Application	Structure	Cross section	Wire colors	Wire insulation	Temperature range	Page
PUR/PVC Black	4-pos., single- occupancy	M12 and QUICKON up to 0.75 mm ² 4 slots	4 x 0.34 mm ² 3 x 0.75 mm ²		White, green, yellow, gray, brown, blue, green-yellow	PVC	Moving: -5°C ... +80°C Fixed: -40°C ... +90°C	262 264 267 305
		M12 and QUICKON up to 0.75 mm ² 6 slots	6 x 0.34 mm ² 3 x 0.75 mm ²		White, green, yellow, gray, pink, red, brown, blue, green-yellow	PVC	Moving: -5°C ... +80°C Fixed: -40°C ... +90°C	262 264 267 305
		M12 and QUICKON up to 0.75 mm ² 8 slots	8 x 0.34 mm ² 3 x 0.75 mm ²		White, green, yellow, gray, pink, red, black, violet, brown, blue, green-yellow	PVC	Moving: -5°C ... +80°C Fixed: -40°C ... +90°C	262 264 267 305
	5-pos., double- occupancy	M12 4 slots	8 x 0.50 mm ² 3 x 1.00 mm ²		White, green, yellow, gray, gray-pink, red-blue, white-green, brown-green, brown, blue, green-yellow	PVC	Moving: -5°C ... +80°C Fixed: -40°C ... +90°C	262 264 305
		M12 6 slots	12 x 0.50 mm ² 3 x 1.00 mm ²		White, green, yellow, gray, pink, red, gray-pink, red-blue, white-green, brown-green, white-yellow, yellow-brown, brown, blue, green-yellow	PVC	Moving: -5°C ... +80°C Fixed: -40°C ... +90°C	262 264 305
		M12 8 slots	16 x 0.50 mm ² 3 x 1.00 mm ²		White, green, yellow, gray, pink, red, black, violet, gray-pink, red-blue, white-green, brown-green, white-yellow, yellow-brown, white-gray, gray-brown, brown, blue, green-yellow	PVC	Moving: -5°C ... +80°C Fixed: -40°C ... +90°C	262 264 305

Sensor/actuator cabling

Sensor/actuator boxes – cable range

PUR/PVC shielded (for sensor/actuator boxes)



The cables are designed for robust use in machine tools, assembly/production lines, as well as production involving metal cutting. Thanks to the tin-plated copper braid with 85% coverage, the cables reliably protect analog signals against electromagnetic influences. The cables are free of silicone and substances that would hinder coating with paint or varnish and have a high

resistance to abrasion. The outer sheath also offers excellent resistance to oil and resistance to chemicals in accordance with VDE 0472 Part 803, is flame-retardant in accordance with DIN EN 50265, and is resistant to hydrolysis.

Outer sheath material	PUR
Inner sheath material	PVC
Minimum bending cycles	1.5 ... 2 million
Minimum bending radius	10 x D
Traverse path	2 m
Speed	2 m/s
Tested at	+20°C ... +25°C

Type	Number of positions	Application	Structure	Cross section	Wire colors	Wire insulation	Temperature range	Page
PUR/PVC shielded Black	5-pos., double-occupancy	M12 4 slots	8 x 0.50 mm ² 3 x 1.00 mm ²		White, green, yellow, gray, pink, red, blue, white-green, brown-green, brown, blue, green-yellow	PVC	Moving: -5°C ... +80°C Fixed: -40°C ... +90°C	305
		M12 6 slots	12 x 0.50 mm ² 3 x 1.00 mm ²		White, green, yellow, gray, pink, red, blue, white-green, brown-green, white-yellow, yellow-brown, brown, blue, green-yellow	PVC	Moving: -5°C ... +80°C Fixed: -40°C ... +90°C	305
		M12 8 slots	16 x 0.50 mm ² 3 x 1.00 mm ²		White, green, yellow, gray, pink, red, black, violet, gray-pink, red-blue, white-green, brown-green, white-yellow, yellow-brown, white-gray, gray-brown, brown, blue, green-yellow	PVC	Moving: -5°C ... +80°C Fixed: -40°C ... +90°C	305

PVC – for the food industry (for sensor/actuator boxes)



Master cable resistant to cleaning agents designed for use in the splash zone. Can be used together with our stainless steel sensor/actuator box to implement signal distribution in a washdown design. The cable is flame-retardant in accordance with IEC 60332-1-2 and UL 758 FT2 and has an oil-resistant outer sheath in accordance with DIN EN 60811-404.

Outer sheath material	PVC
Minimum bending radius	5 x D
Fixed	10 x D
Moving	

Type	Number of positions	Application	Structure	Cross section	Wire colors	Wire insulation	Temperature range	Page
PVC Black	5-pos., double-occupancy	M12 8 slots	16 x 0.50 mm ² 3 x 1.00 mm ²		White, green, yellow, gray, pink, red, black, violet, gray-pink, red-blue, white-green, brown-green, white-yellow, yellow-brown, white-gray, gray-brown, brown, blue, green-yellow	PVC	Moving: -5°C ... +90°C Fixed: -40°C ... +90°C	See: phoenix contact.net/ products

PUR, halogen-free (for sensor/actuator boxes)



Permanently flexible control cables designed for use in drag chains and as machine control cables for extreme operating conditions. The cables are suitable for bending cycle loads with long-term durability. The special PUR outer sheath offers excellent resistance to oils in accordance with VDE 0472 Part 803, lubricants, cooling agents, and other

aggressive substances. Additional features: halogen and PVC-free, free of silicone and substances that would hinder coating with paint or varnish, resistant to hydrolysis, and flame-retardant in accordance with DIN EN 50265.

Outer sheath material PUR
Minimum bending cycles 1.5 ... 2 million
Minimum bending radius 10 x D
Traverse path 2 m
Speed 2 m/s
Tested at +20°C ... +25°C

Type	Number of positions	Application	Structure	Cross section	Wire colors	Wire insulation	Temperature range	Page
PUR Black	5-pos., double- occupancy	M12 4 slots	8 x 0.50 mm ² 3 x 1.00 mm ²		White, green, yellow, gray, gray-pink, red-blue, white-green, brown-green, brown, blue, green-yellow	PP	Moving: -5°C ... +80°C Fixed: -40°C ... +90°C	264 305
		M12 6 slots	12 x 0.50 mm ² 3 x 1.00 mm ²		White, green, yellow, gray, pink, red, gray-pink, red-blue, white-green, brown-green, white-yellow, yellow-brown, brown, blue, green-yellow	PP	Moving: -5°C ... +80°C Fixed: -40°C ... +90°C	264 305
		M12 8 slots	16 x 0.50 mm ² 3 x 1.00 mm ²		White, green, yellow, gray, pink, red, black, violet, gray-pink, red-blue, white-green, brown-green, white-yellow, yellow-brown, white-gray, gray-brown, brown, blue, green-yellow	PP	Moving: -5°C ... +80°C Fixed: -40°C ... +90°C	264 305

80 MC – highly flexible (for sensor/actuator boxes)

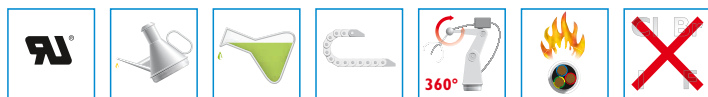

Permanently flexible cables designed for use in drag chains, industrial robots or portal tables. The cables are suitable for bending cycle loads and torsional stress with long-term durability. The special PUR outer sheath offers excellent resistance to oils in accordance with DIN EN 60811-2-1, chemicals, and hydrolysis.

The cable is also flame-retardant in accordance with DIN EN 50265-2-1 and is halogen-free.

Outer sheath material PUR
Minimum bending cycles 5 million
Minimum bending radius 10 x D
Traverse path 5 m
Acceleration 5 m/s²
Speed 3 m/s
Torsion angle +/- 120°
Min. torsion cycles 3 million
Test length 1 m
Tested at +20°C ... +25°C

Type	Number of positions	Application	Structure	Cross section	Wire colors	Wire insulation	Temperature range	Page
80MC Black	5-pos., double- occupancy	M12 8 slots	16 x 0.50 mm ² 3 x 1.00 mm ²		White, green, yellow, gray, pink, red, black, violet, gray-pink, red-blue, white-green, brown-green, white-yellow, yellow-brown, white-gray, gray-brown, brown, blue, green-yellow	PP	Moving: +5°C ... +70°C Fixed: -30°C ... +70°C	305



The following pages provide an overview of the appropriate installation of SAC cables in harsh industrial environments that will guarantee a long service life and reduce costs.

Bending radius

In the case of a moving installation, a generous bending radius can be advantageous. The greater the bending radius, the lower the stress that occurs as a result of movement. The result is an increased cable service life (take into account the minimum cable-specific bending radii).

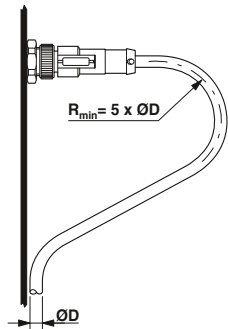

Fixed installation

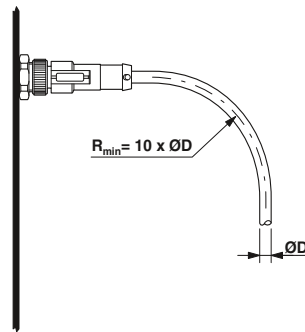

Moving installation

Moving installation

In the case of a moving installation, the cable length should be sufficient to adequately absorb the tensile loads as efficiently as possible. This can be realized, for example, via cable loops and C drag chains.



Load

Prevent the material from aging prematurely by creating a sufficient cable loop at the connection point. This provides sufficient play for absorbing any additional stress that may occur.

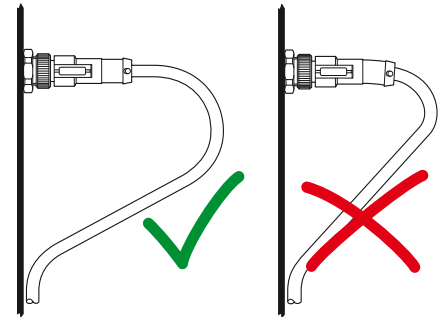

Strain relief for connectors

When installing connectors, make sure that they are protected against tensile loads that may occur. This applies in particular to moveable installations. Support the cables with cable ties, for example.

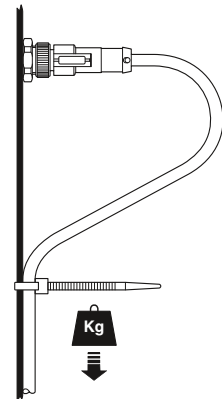

Cables in power track chains

Where possible, cables should be laid individually and loosely next to each other within power track chains. Isolating segments or bridges should be placed between the various cables. Or the cables may be arranged in separate drill holes in the neutral zone.

The laying of cables that have very different outer diameters next to or across each other is not recommended. If, however, this cannot be avoided for design reasons, isolating segments or bridges should be installed to ensure a long service life. If it is not possible to install isolating segments between each cable, we recommend that cables with an outer diameter of <10 mm are laid loose in a guide tube. When doing so, combine cables with similar cross sections.

When arranging the cables, it is important to ensure that heavy cables are routed on the outside and light cables, such as the SAC cables, are routed on the inside. Ensure that there is strain relief on both sides, or at least on the movable end of the drag chain. As a guide value, the distance between the bending motion end and the attachment should be 20 to 30 times the outer diameter.

The cables must be able to move completely freely within the radius of curvature in order to prevent forced guidance of the drag chain. Guide value: 10% of the outer diameter should be allocated as free space.

Note: When laying the cables, observe the information provided by the drag chain manufacturer.

Cable bundling

When bundling several individual cables, it is important to ensure that the cables can move freely within the bundle. The cables must not become deformed. Round cables with greatly varying outer diameters should only be laid next to each other when bridges are used.

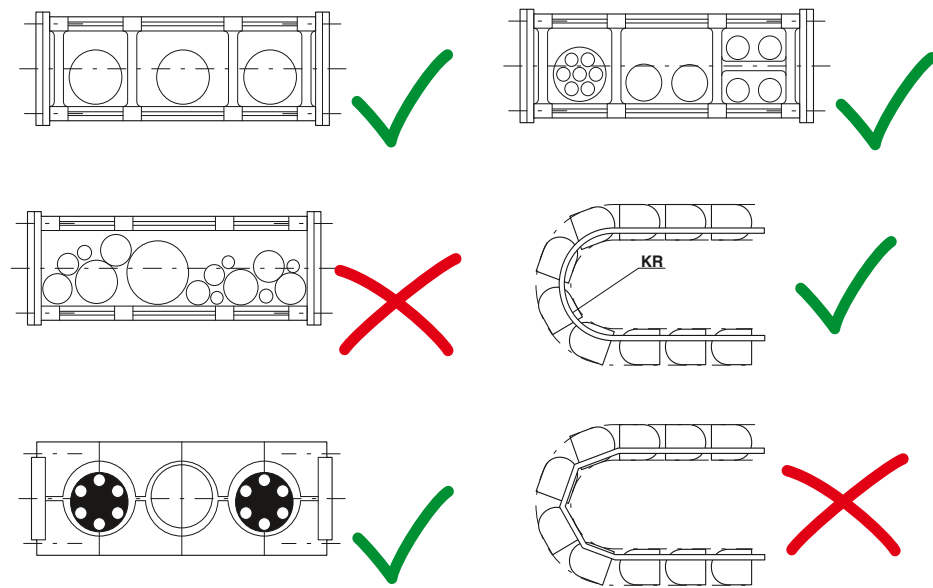
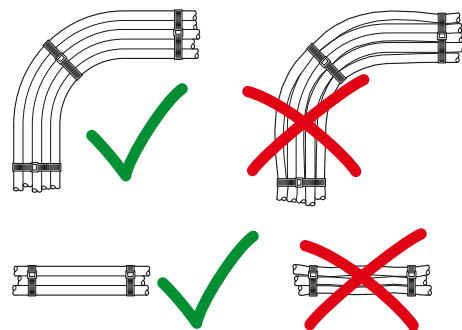

KR = radius of curvature



Data connectors and cables

Complex automation processes call for high volumes of data at ever-increasing transmission speeds. Transmit this data safely and reliably using connectors from Phoenix Contact which are suitable for industrial use.

When it comes to implementing networks, we offer solutions for Industrial Ethernet and PROFINET as well as EtherCAT®. Furthermore, we offer components for fieldbus systems such as PROFIBUS, CANopen®/DeviceNet™, and FOUNDATION Fieldbus.

The product range includes assembled cables, cable connectors, device connectors, and connectors for field assembly. For FO and copper-based cabling we also offer connector systems with innovative connection technologies. These can be wired quickly and securely without special tools.

Active components for networks and fieldbus systems can be found in Catalog 6.

Copper-based data connectors













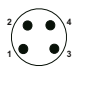
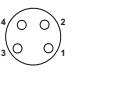
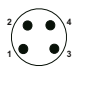
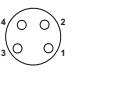
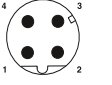
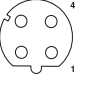
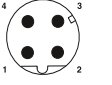
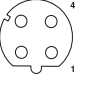
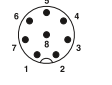
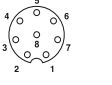
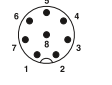
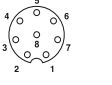

- Future-proof high-speed cabling up to 10 Gbps
- Solutions for IP20, IP65/IP67, and IP69K
- IDC, Push-in, crimp, spring, or pierce connection

Fiber optic-based data connectors

- Transmission speeds of up to 40 Gbps
- Solutions for IP20 and IP65/IP67
- POF, PCF, and GOF fiber types (multi and single mode)

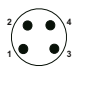
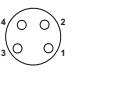
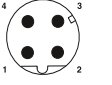
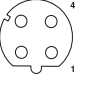
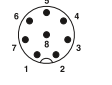
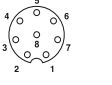
 Your web code: #0296

System overview - network	338
<hr/>	
System overview - fieldbuses	340
<hr/>	
Network components	
M12 connectors	342
Version 6 connectors	350
Version 14 connectors	357
IP20 connectors	372
Accessories	383
Patch cables	386
Assembled cables	392
Assembled FO cables	406
<hr/>	
Fieldbus components	
M12 connectors	422
M12 device connectors	424
Assembled cables	428
AS-Interface	438
D-SUB connectors	444
<hr/>	
D-SUB-based connectors	450
<hr/>	
USB connectors	452
<hr/>	
Cable range	454

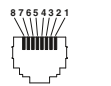
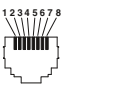
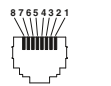
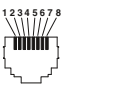
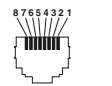
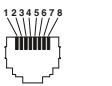
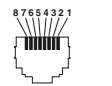
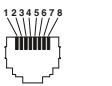
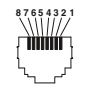
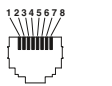
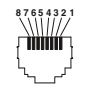
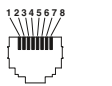
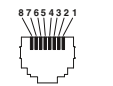
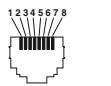
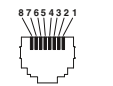
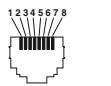
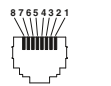
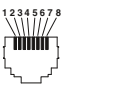
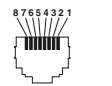
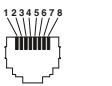
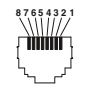
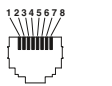
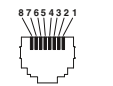
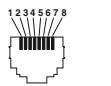
	Ethernet  EtherCAT	Ethernet	Ethernet	Ethernet  EtherNet/IP	Ethernet																																																																																																																		
Area of application	Ethernet M8 (4-pos.) All industrial environments	Ethernet M12 (4-pos.) All industrial environments	Ethernet M12 (8-pos.) All industrial environments	Ethernet M12/10G (8-pos.) All industrial environments	Ethernet hybrid M12 (8-pos.) All industrial environments																																																																																																																		
Topology	Star, tree, or line topology	Star, tree, or line topology	Star, tree, or line topology	Star, tree, or line topology	Star, tree, or line topology																																																																																																																		
Data transmission	Up to 100 Mbps	Up to 100 Mbps	Up to 1 Gbps	Up to 10 Gbps	Up to 100 Mbps																																																																																																																		
Special connectors				M12 with shield crossover	M12 with Y-shield																																																																																																																		
Pin assignment	<table border="1"> <thead> <tr> <th>Signal des.</th> <th colspan="2">Connector</th> </tr> <tr> <th></th> <th>RJ45</th> <th>M8</th> </tr> </thead> <tbody> <tr> <td>TD+</td> <td>1</td> <td>1</td> </tr> <tr> <td>TD-</td> <td>2</td> <td>4</td> </tr> <tr> <td>RD+</td> <td>3</td> <td>2</td> </tr> <tr> <td>RD-</td> <td>6</td> <td>3</td> </tr> </tbody> </table>	Signal des.	Connector			RJ45	M8	TD+	1	1	TD-	2	4	RD+	3	2	RD-	6	3	<table border="1"> <thead> <tr> <th>Signal des.</th> <th colspan="2">Connector</th> </tr> <tr> <th></th> <th>RJ45</th> <th>M12</th> </tr> </thead> <tbody> <tr> <td>TD+</td> <td>1</td> <td>1</td> </tr> <tr> <td>TD-</td> <td>2</td> <td>3</td> </tr> <tr> <td>RD+</td> <td>3</td> <td>2</td> </tr> <tr> <td>RD-</td> <td>6</td> <td>4</td> </tr> </tbody> </table>	Signal des.	Connector			RJ45	M12	TD+	1	1	TD-	2	3	RD+	3	2	RD-	6	4	<table border="1"> <thead> <tr> <th>Signal des.</th> <th colspan="2">Connector</th> </tr> <tr> <th></th> <th>RJ45</th> <th>M12</th> </tr> </thead> <tbody> <tr> <td>D1+</td> <td>1</td> <td>6</td> </tr> <tr> <td>D1-</td> <td>2</td> <td>4</td> </tr> <tr> <td>D3-</td> <td>5</td> <td>1</td> </tr> <tr> <td>D3+</td> <td>4</td> <td>7</td> </tr> <tr> <td>D2+</td> <td>3</td> <td>5</td> </tr> <tr> <td>D2-</td> <td>6</td> <td>8</td> </tr> <tr> <td>D4+</td> <td>7</td> <td>2</td> </tr> <tr> <td>D4-</td> <td>8</td> <td>3</td> </tr> </tbody> </table>	Signal des.	Connector			RJ45	M12	D1+	1	6	D1-	2	4	D3-	5	1	D3+	4	7	D2+	3	5	D2-	6	8	D4+	7	2	D4-	8	3	<table border="1"> <thead> <tr> <th>Signal des.</th> <th colspan="2">Connector</th> </tr> <tr> <th></th> <th>RJ45</th> <th>M12</th> </tr> </thead> <tbody> <tr> <td>D1+</td> <td>1</td> <td>1</td> </tr> <tr> <td>D1-</td> <td>2</td> <td>2</td> </tr> <tr> <td>D3-</td> <td>5</td> <td>7</td> </tr> <tr> <td>D3+</td> <td>4</td> <td>8</td> </tr> <tr> <td>D2+</td> <td>3</td> <td>3</td> </tr> <tr> <td>D2-</td> <td>6</td> <td>4</td> </tr> <tr> <td>D4+</td> <td>7</td> <td>5</td> </tr> <tr> <td>D4-</td> <td>8</td> <td>6</td> </tr> </tbody> </table>	Signal des.	Connector			RJ45	M12	D1+	1	1	D1-	2	2	D3-	5	7	D3+	4	8	D2+	3	3	D2-	6	4	D4+	7	5	D4-	8	6	<table border="1"> <thead> <tr> <th>Signal des.</th> <th colspan="2">Connector</th> </tr> <tr> <th></th> <th colspan="2">M12</th> </tr> </thead> <tbody> <tr> <td>TD+</td> <td colspan="2">1</td> </tr> <tr> <td>TD-</td> <td colspan="2">2</td> </tr> <tr> <td>RD+</td> <td colspan="2">3</td> </tr> <tr> <td>RD-</td> <td colspan="2">4</td> </tr> </tbody> </table>	Signal des.	Connector			M12		TD+	1		TD-	2		RD+	3		RD-	4	
Signal des.	Connector																																																																																																																						
	RJ45	M8																																																																																																																					
TD+	1	1																																																																																																																					
TD-	2	4																																																																																																																					
RD+	3	2																																																																																																																					
RD-	6	3																																																																																																																					
Signal des.	Connector																																																																																																																						
	RJ45	M12																																																																																																																					
TD+	1	1																																																																																																																					
TD-	2	3																																																																																																																					
RD+	3	2																																																																																																																					
RD-	6	4																																																																																																																					
Signal des.	Connector																																																																																																																						
	RJ45	M12																																																																																																																					
D1+	1	6																																																																																																																					
D1-	2	4																																																																																																																					
D3-	5	1																																																																																																																					
D3+	4	7																																																																																																																					
D2+	3	5																																																																																																																					
D2-	6	8																																																																																																																					
D4+	7	2																																																																																																																					
D4-	8	3																																																																																																																					
Signal des.	Connector																																																																																																																						
	RJ45	M12																																																																																																																					
D1+	1	1																																																																																																																					
D1-	2	2																																																																																																																					
D3-	5	7																																																																																																																					
D3+	4	8																																																																																																																					
D2+	3	3																																																																																																																					
D2-	6	4																																																																																																																					
D4+	7	5																																																																																																																					
D4-	8	6																																																																																																																					
Signal des.	Connector																																																																																																																						
	M12																																																																																																																						
TD+	1																																																																																																																						
TD-	2																																																																																																																						
RD+	3																																																																																																																						
RD-	4																																																																																																																						
Signal designation Wire assignment	<table border="1"> <thead> <tr> <th>Wire color</th> <th>Signal</th> </tr> </thead> <tbody> <tr> <td>YE</td> <td>TD+</td> </tr> <tr> <td>OG</td> <td>TD-</td> </tr> <tr> <td>WH</td> <td>RD+</td> </tr> <tr> <td>BU</td> <td>RD-</td> </tr> </tbody> </table>	Wire color	Signal	YE	TD+	OG	TD-	WH	RD+	BU	RD-	<table border="1"> <thead> <tr> <th>Wire color</th> <th>Signal</th> </tr> </thead> <tbody> <tr> <td>WHOG</td> <td>TD+</td> </tr> <tr> <td>OG</td> <td>TD-</td> </tr> <tr> <td>WHGN</td> <td>RD+</td> </tr> <tr> <td>GN</td> <td>RD-</td> </tr> </tbody> </table>	Wire color	Signal	WHOG	TD+	OG	TD-	WHGN	RD+	GN	RD-	<table border="1"> <thead> <tr> <th>Wire color</th> <th>Signal</th> </tr> </thead> <tbody> <tr> <td>WHOG</td> <td>D1+</td> </tr> <tr> <td>OG</td> <td>D1-</td> </tr> <tr> <td>WHBU</td> <td>D3-</td> </tr> <tr> <td>BU</td> <td>D3+</td> </tr> <tr> <td>WHGN</td> <td>D2+</td> </tr> <tr> <td>GN</td> <td>D2-</td> </tr> <tr> <td>WHBN</td> <td>D4+</td> </tr> <tr> <td>BN</td> <td>D4-</td> </tr> </tbody> </table>	Wire color	Signal	WHOG	D1+	OG	D1-	WHBU	D3-	BU	D3+	WHGN	D2+	GN	D2-	WHBN	D4+	BN	D4-	<table border="1"> <thead> <tr> <th>Wire color</th> <th>Signal</th> </tr> </thead> <tbody> <tr> <td>WHOG</td> <td>D1+</td> </tr> <tr> <td>OG</td> <td>D1-</td> </tr> <tr> <td>WHBU</td> <td>D3-</td> </tr> <tr> <td>BU</td> <td>D3+</td> </tr> <tr> <td>WHGN</td> <td>D2+</td> </tr> <tr> <td>GN</td> <td>D2-</td> </tr> <tr> <td>WHBN</td> <td>D4+</td> </tr> <tr> <td>BN</td> <td>D4-</td> </tr> </tbody> </table>	Wire color	Signal	WHOG	D1+	OG	D1-	WHBU	D3-	BU	D3+	WHGN	D2+	GN	D2-	WHBN	D4+	BN	D4-	<table border="1"> <thead> <tr> <th>Wire color</th> <th>Signal</th> </tr> </thead> <tbody> <tr> <td>WHOG</td> <td>TD+</td> </tr> <tr> <td>OG</td> <td>TD-</td> </tr> <tr> <td>WHGN</td> <td>RD+</td> </tr> <tr> <td>GN</td> <td>RD-</td> </tr> <tr> <td>WH</td> <td></td> </tr> <tr> <td>BN</td> <td></td> </tr> <tr> <td>BK</td> <td></td> </tr> </tbody> </table>	Wire color	Signal	WHOG	TD+	OG	TD-	WHGN	RD+	GN	RD-	WH		BN		BK																																											
Wire color	Signal																																																																																																																						
YE	TD+																																																																																																																						
OG	TD-																																																																																																																						
WH	RD+																																																																																																																						
BU	RD-																																																																																																																						
Wire color	Signal																																																																																																																						
WHOG	TD+																																																																																																																						
OG	TD-																																																																																																																						
WHGN	RD+																																																																																																																						
GN	RD-																																																																																																																						
Wire color	Signal																																																																																																																						
WHOG	D1+																																																																																																																						
OG	D1-																																																																																																																						
WHBU	D3-																																																																																																																						
BU	D3+																																																																																																																						
WHGN	D2+																																																																																																																						
GN	D2-																																																																																																																						
WHBN	D4+																																																																																																																						
BN	D4-																																																																																																																						
Wire color	Signal																																																																																																																						
WHOG	D1+																																																																																																																						
OG	D1-																																																																																																																						
WHBU	D3-																																																																																																																						
BU	D3+																																																																																																																						
WHGN	D2+																																																																																																																						
GN	D2-																																																																																																																						
WHBN	D4+																																																																																																																						
BN	D4-																																																																																																																						
Wire color	Signal																																																																																																																						
WHOG	TD+																																																																																																																						
OG	TD-																																																																																																																						
WHGN	RD+																																																																																																																						
GN	RD-																																																																																																																						
WH																																																																																																																							
BN																																																																																																																							
BK																																																																																																																							
Segment length	Up to 100 m from hub/switch to terminal device	Up to 100 m from hub/switch to terminal device	Up to 100 m from hub/switch to terminal device	Up to 100 m from hub/switch to terminal device	Up to 100 m from hub/switch to terminal device																																																																																																																		
User organization			www.odva.org (EtherNet/IP™)	www.odva.org (EtherNet/IP™)																																																																																																																			
Standardization of cabling	ISO/IEC 24702	ISO/IEC 24702	ISO/IEC 24702 (Ethernet) IEC 61784-5-2 (EtherNet/IP™)	ISO/IEC 24702 (Ethernet) IEC 61784-5-2 (EtherNet/IP™)																																																																																																																			
Connector pin assignments	<table border="1"> <tr> <td></td> <td></td> </tr> <tr> <td>Male</td> <td>Female</td> </tr> <tr> <td colspan="2">M8, 4-pos.</td> </tr> </table>			Male	Female	M8, 4-pos.		<table border="1"> <tr> <td></td> <td></td> </tr> <tr> <td>Male</td> <td>Female</td> </tr> <tr> <td colspan="2">M12, 4-pos., D-coded</td> </tr> </table>			Male	Female	M12, 4-pos., D-coded		<table border="1"> <tr> <td></td> <td></td> </tr> <tr> <td>Male</td> <td>Female</td> </tr> <tr> <td colspan="2">M12, 8-pos., A-coded</td> </tr> </table>			Male	Female	M12, 8-pos., A-coded		<table border="1"> <tr> <td></td> <td></td> </tr> <tr> <td>Male</td> <td>Female</td> </tr> <tr> <td colspan="2">M12, 8-pos., X-coded</td> </tr> </table>			Male	Female	M12, 8-pos., X-coded		<table border="1"> <tr> <td></td> <td></td> </tr> <tr> <td>Male</td> <td>Female</td> </tr> <tr> <td colspan="2">M12, hybrid, 8-pos., Y-coded</td> </tr> </table>			Male	Female	M12, hybrid, 8-pos., Y-coded																																																																																					
																																																																																																																							
Male	Female																																																																																																																						
M8, 4-pos.																																																																																																																							
																																																																																																																							
Male	Female																																																																																																																						
M12, 4-pos., D-coded																																																																																																																							
																																																																																																																							
Male	Female																																																																																																																						
M12, 8-pos., A-coded																																																																																																																							
																																																																																																																							
Male	Female																																																																																																																						
M12, 8-pos., X-coded																																																																																																																							
																																																																																																																							
Male	Female																																																																																																																						
M12, hybrid, 8-pos., Y-coded																																																																																																																							
	<table border="1"> <tr> <td></td> <td></td> </tr> <tr> <td>Male</td> <td>Female</td> </tr> <tr> <td colspan="2">RJ45, 8-pos.</td> </tr> </table>			Male	Female	RJ45, 8-pos.		<table border="1"> <tr> <td></td> <td></td> </tr> <tr> <td>Male</td> <td>Female</td> </tr> <tr> <td colspan="2">RJ45, 8-pos.</td> </tr> </table>			Male	Female	RJ45, 8-pos.		<table border="1"> <tr> <td></td> <td></td> </tr> <tr> <td>Male</td> <td>Female</td> </tr> <tr> <td colspan="2">RJ45, 8-pos.</td> </tr> </table>			Male	Female	RJ45, 8-pos.		<table border="1"> <tr> <td></td> <td></td> </tr> <tr> <td>Male</td> <td>Female</td> </tr> <tr> <td colspan="2">RJ45, 8-pos.</td> </tr> </table>			Male	Female	RJ45, 8-pos.																																																																																												
																																																																																																																							
Male	Female																																																																																																																						
RJ45, 8-pos.																																																																																																																							
																																																																																																																							
Male	Female																																																																																																																						
RJ45, 8-pos.																																																																																																																							
																																																																																																																							
Male	Female																																																																																																																						
RJ45, 8-pos.																																																																																																																							
																																																																																																																							
Male	Female																																																																																																																						
RJ45, 8-pos.																																																																																																																							
RJ45 connectors	-	Page 372	Page 372	Page 372	-																																																																																																																		
M12 connectors	-	Page 343	Page 343	Page 342	-																																																																																																																		
Cables	Page 394	Page 398	Page 400	Page 402	Page 405																																																																																																																		
Web code	#0957	#0957	#0957	#0957	#0957																																																																																																																		



Production, process automation in the automotive industry	Production, process automation in the automotive industry	Production, process automation in the automotive industry	Automation technology	Motion control applications	Automation technology
Typically active star topology	Star, line, tree, and ring structures. Hybrid forms also supported	Star, line, tree, and ring structures. Hybrid forms also supported	Line, tree, star, and combinations of these	Line, ring, and hierarchical, cascaded network structures	Tree, line, and star topology
Up to 10 Gbps	100 Mbps	1 Gbps to 10 Gbps	100 Mbps, upgrade to Gigabit Ethernet possible	Fast Ethernet with 100 Mbps	Up to Gigabit Ethernet

M12 with shield crossover

2+4 Power/Ethernet connection technology (IP65 and IP67)

Signal des.	Connector		Signal des.	Connector		Signal des.	Connector		Signal des.	Connector		Signal des.	Connector	
	RJ45	M12		RJ45	M12		RJ45	M12		RJ45	M12		RJ45	M12
D1+	1	1	TD+	1	1	D1+	1	1	TD+	1	1	TD+	2	2
D1-	2	2	TD-	2	3	D1-	2	2	TD-	2	3	TD-	1	3
D3-	5	7	RD+	3	2	D3-	5	7	RD+	3	2	RD+	3	5
D3+	4	8	RD-	6	4	D3+	4	8	RD-	6	4	RD-	6	8
D2+	3	3				D2+	3	3						
D2-	6	4				D2-	6	4						
D4+	7	5				D4+	7	5						
D4-	8	6				D4-	8	6						

Wire color	Signal	Wire color	Signal	Wire color	Signal	Wire color	Signal	Wire color	Signal	Wire color	Signal
WHOG	D1+	YE	TD+	WHOG	D1+	YE	TD+	YE	TD+	n. c.	
OG	D1-	OG	TD-	OG	D1-	OG	TD-	OG	TD-	OG	TD-
WHBU	D3-	WH	RD+	WHBU	D3-	WH	RD+	WH	RD+	WHOG	TD+
BU	D3+	BU	RD-	BU	D3+	BU	RD-	BU	RD-	n. c.	
WHGN	D2+			WHGN	D2+					WHGN	RD+
GN	D2-			GN	D2-					BU	
WHBN	D4+			WHBN	D4+					BN	
BN	D4-			BN	D4-					GN	RD-

Up to 100 m from hub/switch to terminal device	Up to 100 m from hub/switch to terminal device	Up to 100 m from hub/switch to terminal device	Up to 100 m from hub/switch to terminal device	Up to 100 m from hub/switch to terminal device	Up to 100 m from hub/switch to terminal device
--	--	--	--	--	--

www.cc-link.org	www.profinet.com	www.profinet.com	www.ethercat.org	www.sercos.de	www.varan-bus.net
--	--	--	--	--	--

IEEE 802.3	IEC 61784-5-3	IEC 61784-5-3	IEC 61784-5-12	IEC 61784-5-16	
------------	---------------	---------------	----------------	----------------	--

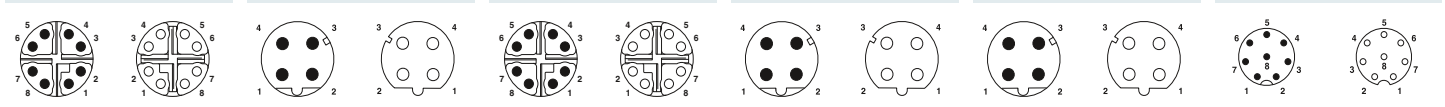

Male	Female	Male	Female	Male	Female	Male	Female	Male	Female	Male	Female
M12, 8-pos., X-coded		M12, 4-pos., D-coded		M12, 8-pos., X-coded		M12, 4-pos., D-coded		M12, 4-pos., D-coded		M12, 8-pos., A-coded	
RJ45, 8-pos.		RJ45, 8-pos.		RJ45, 8-pos.		RJ45, 8-pos.		RJ45, 8-pos.		RJ45, 8-pos.	

Page 372	Page 373	Page 373	Page 373	Page 373	Page 372
Page 342	Page 343	Page 342	Page 343	Page 343	Page 343
Page 402	Page 396	-	Page 396	-	-
#0957	#0957	#0957	#0957	#0957	#0957



Area of application	Sensor/actuator level, process automation, monitoring PC	Decentral I/O devices for networking several controllers	Process automation for potentially explosive areas (Ex zones 0 and 1)	Automation technology																																																																															
Topology	Active ring structure	Line, tree, ring, or star, depending on the physical network design	Line, tree, or ring	Line																																																																															
Data transmission	Between 500 kbps and 16 Mbps, depending on the segment length	Up to 12 Mbps	Up to 31.25 kbps	Up to 500 kBaud																																																																															
Special connectors																																																																																			
Pin assignment	<table border="1"> <thead> <tr> <th rowspan="2">Signal designation</th> <th colspan="2">Connector</th> </tr> <tr> <th>D-SUB 9</th> <th>M12</th> </tr> </thead> <tbody> <tr> <td>DO</td> <td>1</td> <td>2</td> </tr> <tr> <td>DO</td> <td>6</td> <td>1</td> </tr> <tr> <td>DI</td> <td>2</td> <td>4</td> </tr> <tr> <td>DI</td> <td>7</td> <td>3</td> </tr> <tr> <td>GND</td> <td>3</td> <td>5</td> </tr> </tbody> </table>	Signal designation	Connector		D-SUB 9	M12	DO	1	2	DO	6	1	DI	2	4	DI	7	3	GND	3	5	<table border="1"> <thead> <tr> <th rowspan="2">Signal designation</th> <th colspan="2">Connector</th> </tr> <tr> <th>D-SUB 9</th> <th>M12</th> </tr> </thead> <tbody> <tr> <td>A cable</td> <td>8</td> <td>2</td> </tr> <tr> <td>B cable</td> <td>3</td> <td>4</td> </tr> </tbody> </table>	Signal designation	Connector		D-SUB 9	M12	A cable	8	2	B cable	3	4	<table border="1"> <thead> <tr> <th rowspan="2">Signal designation</th> <th colspan="2">Connector</th> </tr> <tr> <th>M12</th> <th></th> </tr> </thead> <tbody> <tr> <td>DATA+</td> <td>1</td> <td></td> </tr> <tr> <td>DATA-</td> <td>3</td> <td></td> </tr> <tr> <td>Shield</td> <td>4</td> <td></td> </tr> </tbody> </table>	Signal designation	Connector		M12		DATA+	1		DATA-	3		Shield	4		<table border="1"> <thead> <tr> <th rowspan="2">Signal designation</th> <th colspan="4">Connector</th> </tr> <tr> <th>COMBICON</th> <th>M12</th> <th>7/8"</th> <th>M8</th> </tr> </thead> <tbody> <tr> <td>CAN_L</td> <td>2</td> <td>5</td> <td>5</td> <td>5</td> </tr> <tr> <td>CAN_H</td> <td>4</td> <td>4</td> <td>4</td> <td>3</td> </tr> <tr> <td>V+</td> <td>5</td> <td>2</td> <td>2</td> <td>2</td> </tr> <tr> <td>V-</td> <td>1</td> <td>3</td> <td>3</td> <td>4</td> </tr> <tr> <td>Drain</td> <td>3</td> <td>1</td> <td>1</td> <td>1</td> </tr> </tbody> </table>	Signal designation	Connector				COMBICON	M12	7/8"	M8	CAN_L	2	5	5	5	CAN_H	4	4	4	3	V+	5	2	2	2	V-	1	3	3	4	Drain	3	1	1	1
Signal designation	Connector																																																																																		
	D-SUB 9	M12																																																																																	
DO	1	2																																																																																	
DO	6	1																																																																																	
DI	2	4																																																																																	
DI	7	3																																																																																	
GND	3	5																																																																																	
Signal designation	Connector																																																																																		
	D-SUB 9	M12																																																																																	
A cable	8	2																																																																																	
B cable	3	4																																																																																	
Signal designation	Connector																																																																																		
	M12																																																																																		
DATA+	1																																																																																		
DATA-	3																																																																																		
Shield	4																																																																																		
Signal designation	Connector																																																																																		
	COMBICON	M12	7/8"	M8																																																																															
CAN_L	2	5	5	5																																																																															
CAN_H	4	4	4	3																																																																															
V+	5	2	2	2																																																																															
V-	1	3	3	4																																																																															
Drain	3	1	1	1																																																																															
Signal designation, wire assignment	<table border="1"> <thead> <tr> <th>Wire color</th> <th>Signal</th> </tr> </thead> <tbody> <tr> <td>YE</td> <td>DO</td> </tr> <tr> <td>GN</td> <td>DO</td> </tr> <tr> <td>GY</td> <td>DI</td> </tr> <tr> <td>PK</td> <td>DI</td> </tr> <tr> <td>BN</td> <td>GND</td> </tr> <tr> <td>WH</td> <td>NC</td> </tr> </tbody> </table>	Wire color	Signal	YE	DO	GN	DO	GY	DI	PK	DI	BN	GND	WH	NC	<table border="1"> <thead> <tr> <th>Wire color</th> <th>Signal</th> </tr> </thead> <tbody> <tr> <td>GN</td> <td>A cable</td> </tr> <tr> <td>RD</td> <td>B cable</td> </tr> </tbody> </table>	Wire color	Signal	GN	A cable	RD	B cable	<table border="1"> <thead> <tr> <th>Wire color</th> <th>Signal</th> </tr> </thead> <tbody> <tr> <td>OG</td> <td>DATA+</td> </tr> <tr> <td>BU</td> <td>DATA-</td> </tr> <tr> <td></td> <td>Flexible filler lead</td> </tr> </tbody> </table>	Wire color	Signal	OG	DATA+	BU	DATA-		Flexible filler lead	<table border="1"> <thead> <tr> <th>Wire color</th> <th>Signal</th> </tr> </thead> <tbody> <tr> <td>BU</td> <td>CAN_L</td> </tr> <tr> <td>WH</td> <td>CAN_H</td> </tr> <tr> <td>RD</td> <td>V+</td> </tr> <tr> <td>BK</td> <td>V-</td> </tr> </tbody> </table>	Wire color	Signal	BU	CAN_L	WH	CAN_H	RD	V+	BK	V-																																									
Wire color	Signal																																																																																		
YE	DO																																																																																		
GN	DO																																																																																		
GY	DI																																																																																		
PK	DI																																																																																		
BN	GND																																																																																		
WH	NC																																																																																		
Wire color	Signal																																																																																		
GN	A cable																																																																																		
RD	B cable																																																																																		
Wire color	Signal																																																																																		
OG	DATA+																																																																																		
BU	DATA-																																																																																		
	Flexible filler lead																																																																																		
Wire color	Signal																																																																																		
BU	CAN_L																																																																																		
WH	CAN_H																																																																																		
RD	V+																																																																																		
BK	V-																																																																																		
	Shield on housing	Shield on housing	Shield on pin	Shield on pin																																																																															
Segment length	400 m segment length between two devices; max. 13 km total length	Up to 1200 m with copper installation, up to 15 km with fiber optic installation	Max. 1900 m	Up to 500 m																																																																															
User organization	www.interbusclub.com	www.profibus.com	www.profibus.com	www.odva.org																																																																															
Standardization of cabling	IEC 61158	IEC 61158 / IEC 61784	IEC 61158 / IEC 61784	IEC 61158 IEC 61784-1 CPF2/3																																																																															
Connector pin assignments	<p>Male Female M12, 5-pos., B-coded</p> <p>Male Female D-SUB 9</p>	<p>Male Female M12, 5-pos., B-coded</p> <p>Male Female D-SUB 9</p>	<p>Male Female M12, 3-pos., A-coded</p>	<p>Male Female M8, 5-pos., B-coded</p> <p>Male Female M12, 5-pos., A-coded</p> <p>Male Female 7/8" 16UNF, 5-pos.</p>																																																																															
Connectors	Page 422	Page 422	Page 423	Page 423																																																																															
Cables	Page 428	Page 429	Page 430	Page 432																																																																															
Web code	#0957	#0957	#0957	#0957																																																																															



Automation technology and for networking within complex devices	Sensor/actuator level	Process automation	All industrial environments	Production level applications
Line or tree (when using repeaters)	Bus, star, ring, and tree structures	Point-to-point line (with branch lines), tree structure, combination of all topologies	Star topology; the connection is established at the star nodes via hubs	Bus, multi-drop, T-branching, star
10 kBaud to 1 Mbaud	167 kbps	H1: 31.25 kbps, IEC physical transmission channel, including Ex bus H2: 1.0 and 2.5 Mbps data rate, via two-wire cable or fiber optics	Up to 480 Mbps	Up to 10 Mbps

Signal designation	Connector					Signal designation	Connector	Signal designation	Connector		Signal designation	Connector		
	COMBICON	D-SUB 9	M12	RU45	7/8"				M12	7/8"			M12, MINI-USB	USB
CAN_L	2	2	5	2	5	AS-i+	1	DATA+	2	2	V _{BUS}	1	SLD	1
CAN_H	4	7	4	1	4	AS-i-	3	DATA-	1	1	D-	2	DB	2
V+	5	9	2	8	2			Shield	3	3	D+	3	DG	3
V-	1	3	3	3	3						ID	4	DA	4
Drain	3	4	1	6	1						GND	5		

Wire color	Signal	Wire color	Signal	Wire color	Signal	Wire color	Signal	Wire color	Signal
BU	CAN_L	BN	AS-i-	OG	DATA+	WHOG	D-	Shield	SLD
WH	CAN_H	WH				WH	V _{BUS}	WH	DB
RD	V+	BU	AS-i+	BU	DATA-	OG	D+	YE	DG
BK	V-	BK				n.c.	ID	BU	DA
					Flexible filler lead	BK	GND		

Shield on pin		Shield on pin 3			
---------------	--	-----------------	--	--	--

Up to 1000 m depending on the transmission speed, can be increased by using repeaters	Max. 100 m cable length, 300 m with termination resistors, 500 m with repeaters	Max. 1900 m; max. 9500 m when using repeaters depending on the selected cable	5 m per segment	Max. 1200 m; max. 13.2 km with repeaters
---	---	---	-----------------	--

www.can-cia.de	www.as-interface.net	www.fieldbus.org	www.usb.org	www.clpa-europe.com
EN 50325-4	EN 50295 and IEC 62026-2	IEC 1158 IEC 61158	Not specified	IEC 61784-1 CPF 8

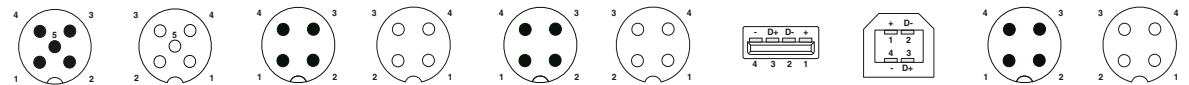

Male	Female	Male	Female	Male	Female	Male, type A	Female, type B	Male	Female
M12, 5-pos., A-coded		M12, 4-pos., A-coded		M12, 4-pos., A-coded		USB, 4-pos.		M12, 4-pos., A-coded	

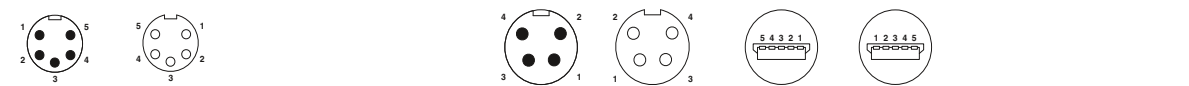

Male	Female	Male	Female	Male	Female
7/8" 16UNF, 5-pos.				7/8" 16UNF, 4-pos.	



Male	Female				
D-SUB 9					
Page 423					Page 423
Page 431	Page 438	Page 435	Page 452		
#0957	#0957	#0957	#0957	#0957	#0957

Connectors and cable connectors, for assembly



Insulation displacement connection QUICKKON



Piercecon® and crimp connection

ERC

ERC

	Technical data		Technical data	
	Ethernet/PROFINET	Ethernet/PROFINET	Ethernet	Ethernet/PROFINET
M12 circular connector in accordance with:	IEC 61076-2-109	-	IEC 61076-2-109	IEC 61076-2-109
Degree of pollution	3	3	3	3
Degree of protection	IP65 / IP67	IP65 / IP67	IP65	IP65 / IP67
Connection method	Insulation displacement connection	Insulation displacement connection	Piercecon®	Crimp connection
Connection cross section	0.14 mm ² ... 0.34 mm ²	0.14 mm ² ... 0.34 mm ²	0.14 mm ² ... 0.14 mm ²	0.14 mm ² ... 0.34 mm ²
External cable diameter	5 mm ... 9.7 mm	5 mm ... 9.7 mm	4 mm ... 8 mm	6.5 mm ... 10 mm
Electrical data				
Rated voltage	48 V AC / 60 V DC	50 V AC / 60 V DC	50 V AC / 60 V DC	48 V AC / 60 V DC
Rated current	0.5 A	0.5 A (30 W)	0.5 A (30 W)	0.5 A
Insulation resistance	≥ 100 MΩ	≥ 100 MΩ	≥ 100 MΩ	≥ 100 Ω
Transmission characteristics (category)	CAT6 _A	CAT6 _A	CAT6 _A	CAT6 _A
Material data				
Contact material	CuSn	CuSn	CuSn	-
Contact surface material	Ni/Au	Ni/Au	Ni/Au	-
Contact carrier material	PA 6.6	PA 6.6	PP	PA 6.6
Flammability rating in accordance with UL 94	V0	V0	V0	V0
Coding	X - data	-	X - data	X - data
Number of positions	8	8	8	8
Temperature data				
Male connector/female connector	-40 ... 85	-40 ... 85	-40 ... 85	-40 ... 85

Description	Ordering data				Ordering data			
	Order No.	Pcs./Pkt.	Order No.	Pcs./Pkt.	Order No.	Pcs./Pkt.	Order No.	Pcs./Pkt.
Connector , shielded, color-coded and numbered connection area								
Male, straight	1411043	1						
Female, straight	1414586	1						
Cable connector , shielded, color-coded and numbered connection area			1414412	1				
Connector , shielded, color-coded connection area								
Male, straight					1417430	1		
Male, angled					1417443	1		
Connector , without contacts, color-coded and numbered contact manager								
Male, straight							1422844	1
Male, angled							1422845	1

	Accessories			Accessories		
	Order No.	Pcs./Pkt.	Order No.	Pcs./Pkt.	Order No.	Pcs./Pkt.
Crimp contacts , gold-plated Male, for X-coded, 0.14 mm ² ... 0.34 mm ²					CC0,6-TS-0,34M AU	1423643 100
Crimping pliers , for turned contacts, universal cross section setting, up to a maximum of 2.5 mm ² , digital display with 0.01 mm increments, unlockable pressure lock, lateral entry, including positioning tool						
for turned contacts, four-mandrel crimping					CRIMPFOX-TC MP	1212510 1
Stripping tool , for multiple-stage repositioning of shielded conductors	VS-CABLE-STRIP-VARIO	1657407	1		VS-CABLE-STRIP-VARIO	1657407 1

M12 push-pull connectors, for assembly

new



Ethernet



Crimp connection

ERC

M12 circular connector in accordance with:

Degree of pollution
Degree of protection
Connection method
External cable diameter
Electrical data
Rated voltage
Rated current
Insulation resistance
Transmission characteristics (category)
Material data
Contact carrier material
Flammability rating in accordance with UL 94
Coding
Number of positions
Temperature data
Male connector/female connector [°C]

Technical data	
PROFINET	Ethernet/PROFINET
-	-
3	3
IP65 / IP67 / IP68 / IP69K	IP65 / IP67 / IP68 / IP69K
Crimp connection	Crimp connection
4.5 mm ... 7.5 mm	6.5 mm ... 10 mm
48 V AC / 60 V DC	48 V AC / 60 V DC
4 A	0.5 A
≥ 100 Ω	≥ 100 Ω
CAT5	CAT6 _A
PA 6.6	PA 6.6
V0	V0
D - data	X - data
4	8
-40 ... 85	-40 ... 85

Description
Push-pull connector, 100 Mbps, 4-pos., shielded
Male, straight
Male, angled
Push-pull connector, 8-pos., shielded
Male, straight
Male, angled

Ordering data			
Order No.	Pcs./Pkt.	Order No.	Pcs./Pkt.
PROFINET		Ethernet/PROFINET	
1021830	1		
1021831	1		
		1021783	1
		1021784	1

Crimp contacts, gold-plated
Male, for A-/D-coded, 0.14 mm ² ... 0.34 mm ²
Male, for A/D-coded, 0.34 mm ² ... 1.0 mm ²
Male, for X-coded, 0.14 mm ² ... 0.34 mm ²
Crimping pliers , for turned contacts, universal cross section setting, up to a maximum of 2.5 mm ² , digital display with 0.01 mm increments, unlockable pressure lock, lateral entry, including positioning tool
for turned contacts, four-mandrel crimping
Stripping tool , for multiple-stage repositioning of shielded conductors

Accessories		
CC1,0-TS-0,34M AU	1064040	100
CC1,0-TS-1,00M AU	1423645	100
CC0,6-TS-0,34M AU	1423643	100
CRIMPFox-TC MP	1212510	1
VS-CABLE-STRIP-VARIO	1657407	1

M12 push-pull locking, with 0.5 m litz wires

- Front mounting
- Manufacturer-independent M12 push-pull locking system



Technical data	
4-pos.	
General data	
M12 circular connector in accordance with:	-
Degree of pollution	3
Degree of protection	IP65/IP67
Connection method	Individual wires
Electrical data	
Rated voltage	250 V
Rated current	4 A
Material data	
Material contact/contact surface	CuZn / Ni/Au
Contact carrier material	PA 6.6
Flammability rating in accordance with UL 94	V0
Cable type	TPE litz wire
Temperature data	
Male connector/female connector	-25 ... 85 [°C]



Technical data	
5-pos.	
General data	
M12 circular connector in accordance with:	-
Degree of pollution	3
Degree of protection	IP65/IP67
Connection method	Individual wires
Electrical data	
Rated voltage	60 V
Rated current	4 A
Material data	
Material contact/contact surface	CuZn / Ni/Au
Contact carrier material	PA 6.6
Flammability rating in accordance with UL 94	V0
Cable type	TPE litz wire
Temperature data	
Male connector/female connector	-25 ... 85

Ordering data			
Description	Coding	Order No.	Pcs./Pkt.
		4-pos.	
Female	A-coded		
Female	D-coded	1027686	1

Ordering data			
Description	Coding	Order No.	Pcs./Pkt.
		5-pos.	
Female	A-coded	1027683	1

Data connectors and cables

Network components – M12 connectors

M12 push-pull locking, with 0.5 m litz wires

- Rear mounting
- Manufacturer-independent M12 push-pull locking system



Technical data

4-pos.

General data
M12 circular connector in accordance with:
Degree of pollution
Degree of protection
Connection method
Electrical data
Rated voltage
Rated current
Material data
Material contact/contact surface
Contact carrier material
Flammability rating in accordance with UL 94
Cable type
Temperature data
Male connector/female connector [°C]

IEC 61076-2-101
3
IP67
Individual wires

250 V
4 A

CuZn / Au
PA 6.6
V0
TPE litz wire

-25 ... 85

Ordering data

Description	Coding
Device connectors	
Female	A-coded
Female	D-coded

Order No. Pcs./Pkt.
4-pos.

1027670 1



Technical data

5-pos.

General data
M12 circular connector in accordance with:
Degree of pollution
Degree of protection
Connection method
Electrical data
Rated voltage
Rated current
Material data
Material contact/contact surface
Contact carrier material
Flammability rating in accordance with UL 94
Cable type
Temperature data
Male connector/female connector [°C]

IEC 61076-2-101
3
IP67
Individual wires

60 V
4 A

CuZn / Au
PA 6.6
V0
TPE litz wire

-25 ... 85

Ordering data

Description	Coding
Device connectors	
Female	A-coded
Female	D-coded

Order No. Pcs./Pkt.
5-pos.

1027666 1

Device connectors,
with 0.5 m litz wires



Front mounting,
4-pos.



Rear mounting,
4-pos.



	Technical data		Technical data	
	4-pos.	4-pos.	4-pos.	
General data				
M12 circular connector in accordance with:	IEC 61076-2-101	IEC 61076-2-101	IEC 61076-2-101	
Degree of pollution	3	3	3	
Degree of protection	IP65/IP67	IP67	IP65/IP67	
Connection method	Individual wires	Individual wires	Individual wires	
Electrical data				
Rated voltage	250 V	250 V	250 V	
Rated current	4 A	4 A	4 A	
Material data				
Material contact/contact surface	CuZn / Ni/Au	CuZn / Ni/Au	CuZn / Ni/Au	
Contact carrier material	PA 6.6	PA 6.6	PA 6.6	
Flammability rating in accordance with UL 94	V0	V0	V0	
Cable type	TPE litz wire	TPE litz wire	TPE litz wire	
Temperature data				
Male connector/female connector	[°C]	-25 ... 85	-25 ... 85	-25 ... 85
	Ordering data		Ordering data	
	Order No.	Pcs./Pkt.	Order No.	Pcs./Pkt.
Description	Coding			
Bus system flush-type socket, PROFINET, 4-pos., M12 SPEEDCON, D-coded, front/screw mounting with M16 thread, with 0.5 m TPE litz wire, 4 x 0.34 mm ²				
Female	D - data	1535202	1	
Bus system flush-type socket, PROFINET, 4-pos., M12 SPEEDCON, D-coded, front/screw mounting with M16 thread, can be positioned, with 0.5 m TPE litz wire, 4 x 0.34 mm ²				
Female	D - data		1535215	1
Bus system flush-type socket, PROFINET, 4-pos., M12 SPEEDCON, D-coded, rear/screw mounting with Pg9 thread, with 0.5 m TPE litz wire, 4 x 0.34 mm ²				
Female	D - data			1551529
				1

Control cabinet feed-throughs, bulkhead, M12 to RJ45 socket



**Bulkhead,
10 Gbps**



**Bulkhead,
100 Mbps and 1 Gbps**



Technical data

Electrical data	VS-BH-M12FSX-10G-RJ45...
Nominal voltage U_N	60 V
Rated current	0.5 A
Transmission characteristics (category)	CAT6 _A
Contact material	Copper alloy
Material of grip body	PA
Flammability rating in accordance with UL 94	V0
Insertion/withdrawal cycles	≥ 100
Temperature data	
Male connector/female connector	-25 ... 85 [°C]



Technical data

CUC-BH-M12A1PBK-A/R4BE	CUC-BH-M12D1PBK-A/R4BE
60 V	60 V
0.5 A	0.5 A
CAT5 (IEC 11801:2002)	CAT5 (IEC 11801:2002)
Copper alloy	Copper alloy
PA	PA
V0	V0
≥ 100	≥ 100
-25 ... 85	-25 ... 85

Ordering data

Description	Type	Order No.	Pcs./Pkt.
Control cabinet feed-through, CAT6_A, M12, 8-pos., X-coded to RJ45 socket			
Female exit 90°	VS-BH-M12FSX-10G-RJ45/90	1404548	1
Female exit 180°	VS-BH-M12FSX-10G-RJ45/180	1404549	1
Control cabinet feed-through, M12, 8-pos., A-coded on RJ45 socket			
Female exit 90°			
Female exit 180°			
Control cabinet feed-through, M12, 4-pos., D-coded on RJ45 socket			
Female exit 90°			
Female exit 180°			

Ordering data

Description	Type	Order No.	Pcs./Pkt.
Control cabinet feed-through, CAT5, M12, 8-pos., A-coded on RJ45 socket			
Female exit 90°	CUC-BH-M12A1PBK-A/R4BE	1414393	1
Female exit 180°	CUC-BH-M12A1PBK-S/R4BE	1414396	1
Control cabinet feed-through, CAT5, M12, 8-pos., D-coded on RJ45 socket			
Female exit 90°	CUC-BH-M12D1PBK-A/R4BE	1414397	1
Female exit 180°	CUC-BH-M12D1PBK-S/R4BE	1414398	1

Terminal outlets, IP65/IP67

- Easy installation, thanks to captive cover screws
- Robust design
- Integrated cable management system



**Terminal outlet
with 2 x M12 slots**

ERC

Technical data

VS-TO-RO-MCBK-F142...

Electrical data	
Transmission characteristics (category)	CAT5 (IEC 11801:2002)
Material data	
Housing material	Aluminum cast alloy, powder-coated
Mechanical data	
Color	black
Degree of protection	IP65/IP67

Ordering data

Description	Type	Order No.	Pcs./Pkt.
Terminal outlet, M12, IP65/67, 2 slots, with protective plugs, 2 cable entries			
M12 with 2 x female, 8-pos., A-keyed	VS-TO-RO-MCBK-F1422/1422	1404304	1
M12 with 2 x female, 4-pos., D-coded	VS-TO-RO-MCBK-F1421/1421	1404294	1

RJ45 connectors, IP65/67



RJ45 connector



RJ45 connector with field and crimp connection

Technical data	
Electrical data	
Rated voltage	72 V (DC)
Rated current	1.75 A
Overtoltage category	I
Material data	
Housing material	PA
Contact material	Copper alloy
Flammability rating in accordance with UL 94	V0
Degree of pollution	2
Connection data	
Connection method	IDC fast connection
Connection cross section AWG	26 ... 23 (rigid)
Connection cross section AWG	26 ... 23 (flexible)
External cable diameter	5 mm ... 8.5 mm
Insertion/withdrawal cycles	≥ 1000
Temperature data	
Ambient temperature (operation)	-20°C ... 70°C

Technical data	
VS-08-RJ45-5-Q/IP67...	CUC-V06-C1...-S/R4...8:1
Rated voltage	72 V (DC)
Rated current	1 A
Overtoltage category	I
Material data	
Housing material	PA
Contact material	Phosphor bronze
Flammability rating in accordance with UL 94	V0
Degree of pollution	2
Connection data	
Connection method	Crimp connection
Connection cross section AWG	27 ... 24 (flexible)
Connection cross section AWG	-
External cable diameter	5 mm ... 8.5 mm
Insertion/withdrawal cycles	≥ 750
Temperature data	
Ambient temperature (operation)	-25°C ... 60°C

Technical data	
VS-08-T-H-RJ45...	VS-08-ST-H21P-RJ45
Rated voltage	72 V (DC)
Rated current	1 A
Overtoltage category	I
Material data	
Housing material	PA
Contact material	Phosphor bronze
Flammability rating in accordance with UL 94	V2
Degree of pollution	2
Connection data	
Connection method	IDC connection technology
Connection cross section AWG	27 ... 24 (flexible)
Connection cross section AWG	-
External cable diameter	5 mm ... 8.5 mm
Insertion/withdrawal cycles	≥ 1000
Temperature data	
Ambient temperature (operation)	-25°C ... 60°C

Ordering data	
Description	
RJ45 connector , 8-pos., CAT5, with QUICKON fast connection technology, for 26 ... 24 AWG	
Military gray RAL 7042 deep black RAL 9005	
RJ45 connector , 8-pos., CAT6, 1 Gbps, with crimp connection, for 27 ... 24 AWG	
Military gray RAL 7042 deep black RAL 9005	
RJ45 connector , 8-pos., CAT6 _A , 10 Gbps, with crimp connection, for 27 ... 24 AWG	
Military gray RAL 7042 deep black RAL 9005	
Sleeve housing , for VS-08-ST-H...-RJ45 male insert, for cable diameter of 5.0 mm ... 8.5 mm	
Military gray RAL 7042 deep black RAL 9005	
RJ45 male insert , 8-pos., shielded, IDC connection technology, for 27 ... 26 AWG litz wires, with strain relief	
CAT5 CAT6	
RJ45 male insert , 8-pos., shielded, IDC pierce connection, for litz wires AWG 27 ... 24, with strain relief	
CAT6	
RJ45 male insert , CAT6 _A , 10 Gbps	

Type	Order No.	Pcs./Pkt.
VS-08-RJ45-5-Q/IP67	1656990	1
VS-08-RJ45-5-Q/IP67-BK	1658493	1
CUC-V06-C1PGY-S/R4CE8:1	1414383	1
CUC-V06-C1PBK-S/R4CE8:1	1414408	1
CUC-V06-C1PGY-S/R4CEA:1	1414406	1
CUC-V06-C1PBK-S/R4CEA:1	1414410	1
VS-08-T-H-RJ45/IP67	1652732	5
VS-08-T-H-RJ45/IP67-BK	1658671	5
VS-08-ST-H11-RJ45	1652716	5
VS-08-ST-H21-RJ45	1652729	5
VS-08-ST-H21P-RJ45	1404388	5
VS-08-RJ45-10G/C	1418853	5

Type	Order No.	Pcs./Pkt.
VS-08-T-H-RJ45/IP67	1652732	5
VS-08-T-H-RJ45/IP67-BK	1658671	5
VS-08-ST-H11-RJ45	1652716	5
VS-08-ST-H21-RJ45	1652729	5
VS-08-ST-H21P-RJ45	1404388	5
VS-08-RJ45-10G/C	1418853	5

Accessories	
Stripping tool , for multiple-stage repositioning of shielded conductors	
Crimp tool , pliers with die, for VS-08-ST-H...-RJ45	

Accessories	
VS-CABLE-STRIP-VARIO	1657407
VS-CT-RJ45-H	1653265

Accessories	
VS-CABLE-STRIP-VARIO	1657407
VS-CT-RJ45-H	1653265

RJ45 panel mounting frames and Freenet socket inserts, IP20



Keystone panel mounting frames and keystones



Freenet panel mounting frames and modules

	Technical data			Technical data		
	VS-08-...-RJ45-...			CUC-F-...-S/R4IDC8	VS-08-BU-RJ45-5-F/PK	
Electrical data						
Nominal voltage U _N	-			72 V (DC)	50 V	
Rated current	-			1.5 A	1 A	
Housing material	Zinc die-cast			Zinc die-cast	Copper alloy	
Contact material	Phosphor bronze			CuSn	Copper alloy	
Flammability rating in accordance with UL 94	V0			V0	V0	
Number of positions	8			8	8	
Connection method	2x RJ45			IDC connection	IDC	
Insertion/withdrawal cycles	≥ 750			≥ 750	≥ 750	
Temperature data						
Ambient temperature (operation)	-10°C ... 60°C			-25°C ... 70°C	-20°C ... 70°C	
	Ordering data			Ordering data		
Description	Type	Order No.	Pcs./Pkt.	Type	Order No.	Pcs./Pkt.
RJ45 socket insert, 8-pos., shielded, female to female						
CAT5	VS-08-BU-RJ45/BU	1689064	5			
CAT6	VS-08-BU-RJ45-6-MOD/BU	1653155	5			
RJ45 keystone panel mounting frame, Version 6, for round mounting cutout, with seal and central nut						
Military gray RAL 7042	VS-08-A-RJ45/MOD-1-R-IP67	1689844	1			
deep black RAL 9005	VS-08-A-RJ45/MOD-1-R-IP67 BK	1658053	5			
RJ45 keystone panel mounting frame, Version 6, with rectangular mounting cutout, with seal, without mounting screws						
Military gray RAL 7042	VS-08-A-RJ45/MOD-1-IP67	1689080	5			
deep black RAL 9005	VS-08-A-RJ45/MOD-1-IP67-BK	1658642	5			
RJ45 Freenet socket insert, 8-pos., shielded, with cable connection						
10 Gbps, CAT6 _A				CUC-F-J1ZNI-S/R4IDC8	1418984	1
RJ45 Freenet socket insert, 8-pos., shielded, with cable connection						
1 Gbps, CAT5				VS-08-BU-RJ45-5-F/PK	1652936	1
RJ45 Freenet socket insert, 8-pos., shielded, female to female						
1 Gbps, CAT6				CUC-F-D1ZNI-S/R4GC8	1419022	1
Freenet panel mounting frame, Version 6, for round mounting cutout, with seal, without mounting screws						
Military gray RAL 7042				VS-A-F-IP67	1653744	5
deep black RAL 9005				VS-A-F-IP67-BK	1658668	5
	Accessories			Accessories		
Protective cover for Version 6 panel mounting frame						
Military gray RAL 7042	VS-08-SD-F	1652606	5	VS-08-SD-F	1652606	5
deep black RAL 9005	VS-08-SD-F-BK	1658066	5	VS-08-SD-F-BK	1658066	5
Stripping tool, for multiple-stage repositioning of shielded conductors	VS-CABLE-STRIP-VARIO	1657407	1	VS-CABLE-STRIP-VARIO	1657407	1

RJ45 terminal outlets, IP65/IP67

- Robust design
- Including covers to protect against environmental influences
- Integrated cable management system



**Terminal outlet
with 2 x RJ45 slots**

ERC

Technical data

VS-TO-RO-MCBK-F141...

Electrical data

Transmission characteristics (category)

CAT6

Material data

Housing material

Aluminum cast alloy, powder-coated

Mechanical data

Color

black

Ordering data

Description

**Terminal outlet RJ45 IP65/67, 2 slots version 6,
with protective plugs, 2 cable entries**

2x RJ45

Type

Order No.

Pcs./Pkt.

VS-TO-RO-MCBK-F1418/1418

1404278

1

Field couplings, IP65/67

- Fixed mounting is also an option
- Including covers to protect against environmental influences



Field coupling
with RJ45



Technical data

VS-08-KU-IP67

Electrical data	
Rated voltage	72 V (DC)
Rated current	1 A
Transmission characteristics (category)	CAT5 (IEC 11801:2002)
Material data	
Housing material	PBT
Contact material	Copper alloy
Flammability rating in accordance with UL 94	V0
Mechanical data	
Number of positions	8
Temperature data	
Ambient temperature (operation)	-10°C ... 60°C

Ordering data

Description	Type	Order No.	Pcs./Pkt.
RJ45 coupling , IP67, CAT5, with protective cover			
Military gray RAL 7042	VS-08-KU-IP67	1689268	1
deep black RAL 9005	VS-08-KU-IP67-BK	1658684	1

FO connectors, IP65/67

Notes:
For further technical data, see:
phoenixcontact.net/products



SC-RJ connector
for polymer fiber 980/1000 µm



SC-RJ connector
for PCF fibers 200 / 230 µm and
polymer fibers 980 / 1000 µm

ERC®

Technical data

Material data
Housing material
Ferrule material
Flammability rating in accordance with UL 94
Color
Degree of protection
External cable diameter
Wire diameter
Ferrule diameter
Insertion/withdrawal cycles
Temperature data
Ambient temperature (operation)

PA
Copper alloy
V0
gray
IP67
5 mm ... 8.5 mm
2.2 mm
2.50 mm
≥ 1000

-20°C ... 70°C

Ordering data

Description
FO connector SC-RJ , duplex, with fast connection
POF fiber 980/1000 µm SC-RJ socket insert , duplex, for VARIOSUB IP67 panel mounting frame, can be used for GOF multimode, GOF single mode, PCF, and POF fiber types
1x SC-RJ/SC-RJ (duplex) VS-SC-RJ panel mounting frame , for use with an AVAGO transceiver, type: AFBR 5978Z
Freenet panel mounting frame , Version 6, for round mounting cutout, with seal, without mounting screws
Military gray RAL 7042 deep black RAL 9005

Type	Order No.	Pcs./Pkt.
VS-SCRJ-POF-FA-IP67	1657009	1

Accessories

Protective cover SC-RJ/IP67 , for covering the SC-RJ male insert on the SC-RJ/IP67 sleeve housing
Protective cover for Version 6 panel mounting frame Military gray RAL 7042 deep black RAL 9005
Tool set for POF assembly , for field installation of SC connectors.

VS-SCRJ-PC	1653757	5
TF-SCRJ-POF KONF SET	1405246	1

ERC

Technical data

PBT
Zirconia ceramics
V0
black
IP20
-
2.50 mm
≥ 500

-25°C ... 70°C

Ordering data

Type	Order No.	Pcs./Pkt.
VS-SCRJ-GOF-BU/BU	1652978	1
VS-SCRJ-A-TC-IP67	1658545	1
VS-A-F-IP67	1653744	5
VS-A-F-IP67-BK	1658668	5

Accessories

VS-08-SD-F	1652606	5
VS-08-SD-F-BK	1658066	5

**SC-RJ terminal outlets,
IP65/67**

- Easy installation, thanks to captive cover screws
- Robust design
- Including covers to protect against environmental influences
- Integrated cable management system



**Terminal outlet, IP67,
with 2 x SC-RJ slots**

ERC

Technical data

Material data	
Housing material	Aluminum cast alloy, powder-coated
Ferrule material	Zirconia ceramics
Mechanical data	
Color	black
Degree of protection	IP65/IP67
Fiber type	GOF, PCF, POF
Connection profile	SCRJ in accordance with DIN EN 50377-6-1
Insertion/withdrawal cycles	≥ 500

Ordering data

Description	Type	Order No.	Pcs./Pkt.
SC-RJ terminal outlet, IP65/IP67, 2 slots, Version 6, with protective plugs, 2 cable entries	VS-TO-RO-MCBK-F1420/1420	1404317	1

SC-RJ couplings, IP65/67

- Fixed mounting is also an option
- Including covers to protect against environmental influences
- Can be used for all fiber types



SC-RJ field coupling

ERC

Technical data

Material data	
Housing material	PBT
Contact material	-
Ferrule material	Zirconia ceramics
Flammability rating in accordance with UL 94	V0
Mechanical data	
Number of positions	2
Color	gray
Degree of protection	IP65/IP67
Temperature data	
Ambient temperature (operation)	-10°C ... 60°C

Ordering data

Description	Type	Order No.	Pcs./Pkt.
	SC-RJ coupling, IP67, duplex, can be used for GOF (multimode and single mode), PCF, and polymer fiber types	FOC-V06-D1PGY-S/SJBE4	1410050 1

Push-Pull ADVANCE connectors, IP65/IP67

- High resistance to ESD and EMI for reliable transmission
- Easy handling, thanks to one-piece design
- Locking system to prevent unintentional removal
- Consistent 360° shielding concept



RJ45 connector, straight cable outlet



RJ45 connector, cable outlet at the top

ERIC

	Technical data				Technical data			
Degree of protection	Ethernet IP65/IP67		PROFINET IP65/IP67		Ethernet IP65/IP67		PROFINET IP65/IP67	
Connection cross section AWG	26 ... 24 (rigid)		23 ... 22 (rigid)		26 ... 24 (rigid)		23 ... 22 (rigid)	
Transmission speed	1 Gbps		1 Gbps		1 Gbps		1 Gbps	
Housing material	Zinc die-cast		Zinc die-cast		Zinc die-cast		Zinc die-cast	
External cable diameter	5.5 mm ... 10 mm		5.5 mm ... 10 mm		5.5 mm ... 10 mm		5.5 mm ... 10 mm	
Insertion/withdrawal cycles	≥ 750		≥ 750		≥ 750		≥ 750	
Temperature data								
Ambient temperature (operation)	-40°C ... 70°C		-40°C ... 70°C		-40°C ... 70°C		-40°C ... 70°C	
	Ordering data				Ordering data			
Description	Order No.	Pcs./Pkt.	Order No.	Pcs./Pkt.	Order No.	Pcs./Pkt.	Order No.	Pcs./Pkt.
	Ethernet		PROFINET		Ethernet		PROFINET	
Push-pull ADVANCE , RJ45 industrial connector, IP67, 8-pos.								
Single pack	1422661	1	1422664	1	1422663	1	1422667	1
	Accessories				Accessories			
Stripping tool , for multiple-stage repositioning of shielded conductors	VS-CABLE-STRIP-VARIO		1657407	1	VS-CABLE-STRIP-VARIO		1657407	1
Electronic diagonal cutter , tapered head, without chamfer, with opening spring, non-reflective phosphate-treated surface, punched version	MICROFOX-SP-1		1212487	1	MICROFOX-SP-1		1212487	1

Push-Pull ADVANCE connectors, IP65/IP67



RJ45 connector,
cable outlet at the bottom



RJ45 connector,
straight cable outlet

ERC

	Technical data				Technical data			
	Ethernet		PROFINET		Ethernet		PROFINET	
Degree of protection	IP65/IP67		IP65/IP67		IP65/IP67		IP65/IP67	
Connection cross section AWG	26 ... 24 (rigid)		23 ... 22 (rigid)		27 ... 24 (flexible)		26 ... 22 (rigid)	
Transmission speed	1 Gbps		1 Gbps		10 Gbps		-	
Housing material	Zinc die-cast		Zinc die-cast		Plastic		PA-GF	
External cable diameter	5.5 mm ... 10 mm		5.5 mm ... 10 mm		5 mm ... 8 mm		5 mm ... 8 mm	
Insertion/withdrawal cycles	≥ 750		≥ 750		≥ 200		≥ 500	
Temperature data								
Ambient temperature (operation)	-40°C ... 70°C		-40°C ... 70°C		-25°C ... 60°C		-10°C ... 60°C	
	Ordering data				Ordering data			
	Order No.	Pcs./Pkt.	Order No.	Pcs./Pkt.	Order No.	Pcs./Pkt.	Order No.	Pcs./Pkt.
Description	Ethernet		PROFINET		Ethernet		PROFINET	
Push-pull ADVANCE , RJ45 industrial connector, IP67, 8-pos.								
Single pack	1422662	1	1422665	1				
Push/pull connector (version 14) for 10 Gbps, with RJ45 crimp connection, for 26 ... 24 AWG flexible conductors, 5.0 mm ... 8.0 mm cable diameter								
8-pos., 10 Gbps					1422205	1		
Push-pull connector (version 14) for PROFINET with RJ45 QUICKON fast connection technology, for 22 AWG 1 and 7-wire conductors, cable diameter of 5.0 mm ... 8.0 mm								
4-pos., 100 Mbps							1608126	1
4-pos., 1 Gbps							1404142	1
8-pos., 1 Gbps							1657834	1
	Accessories				Accessories			
Stripping tool , for multiple-stage repositioning of shielded conductors	VS-CABLE-STRIP-VARIO	1657407		1	VS-CABLE-STRIP-VARIO	1657407		1
Electronic diagonal cutter , tapered head, without chamfer, with opening spring, non-reflective phosphate-treated surface, punched version	MICROFOX-SP-1	1212487		1				
Protective cover, IP65 , with push/pull locking, for covering the contact insert in the push/pull connector for RJ45 and SC-RJ, plastic					VS-PPC-F1-PC-POBK	1405316		1
Shielding foil set , 25 pcs., replacement for VS-PN-RJ45-5-Q/IP20					VS-08-RJ45-FOLIEN-SET	1417184		1

Push-pull connectors,
IP65/IP67



RJ45 connector,
straight cable outlet



RJ45 connectors, EMC,
straight cable outlet



Degree of protection
Connection cross section AWG
Transmission speed
Housing material
External cable diameter
Insertion/withdrawal cycles
Temperature data
Ambient temperature (operation)

Technical data	
PROFINET	PROFINET
IP65/IP67	IP65/IP67
26 ... 22 (rigid)	26 ... 22 (rigid)
100 Mbps	-
Zinc die-cast	Zinc die-cast
5 mm ... 8 mm	5 mm ... 8 mm
≥ 500	≥ 500
-40°C ... 70°C	-40°C ... 70°C

Technical data	
PROFINET	PROFINET
IP65/IP67	IP65/IP67
22 ... 22 (rigid)	22 ... 22 (rigid)
-	-
Zinc die-cast	Zinc die-cast
5 mm ... 8 mm	5 mm ... 8 mm
≥ 500	≥ 500
-40°C ... 70°C	-40°C ... 70°C

Description

Ordering data			
Order No.	Pcs./Pkt.	Order No.	Pcs./Pkt.
PROFINET		PROFINET	

Ordering data			
Order No.	Pcs./Pkt.	Order No.	Pcs./Pkt.
PROFINET		PROFINET	

Push-pull connector (version 14) for PROFINET with RJ45 QUICKON fast connection technology, for 22 AWG 1 and 7-wire conductors, cable diameter of 5.0 mm ... 8.0 mm

4-pos., 100 Mbps
8-pos., 100 Mbps

1608100 1
1608016 1

Push-pull connector (version 14) for PROFINET with RJ45 QUICKON fast connection technology, for 22 AWG 1 and 7-wire conductors, cable diameter of 5.0 mm ... 8.0 mm

4-pos., 1 Gbps
8-pos., 1 Gbps

1405141 1
1404126 1

Push-pull connector (Version 14) optimized for use in environments subject to EMI, with RJ45 QUICKON fast connection technology, for 5.0 mm ... 8.0 mm cable diameter

4-pos., 100 Mbps
8-pos., 100 Mbps

1403366 1
1403367 1

Stripping tool, for multiple-stage repositioning of shielded conductors

Accessories		
VS-CABLE-STRIP-VARIO	1657407	1

Accessories		
VS-CABLE-STRIP-VARIO	1657407	1

RJ45 panel mounting frames and Freenet socket inserts, IP20



Panel mounting frame and modules



Freenet panel mounting frame with central nut and modules

	Technical data			Technical data		
Electrical data	VS-08-BU-RJ45-5-F/PK			CUC-F...-S/R4IDC8		
Nominal voltage U_N	50 V			-		
Rated current	1 A			-		
Housing material	Copper alloy			Zinc die-cast		
Contact material	Copper alloy			Spring steel		
Flammability rating in accordance with UL 94	V0			-		
Number of positions	8			8		
Connection method	IDC			Female		
Insertion/withdrawal cycles	≥ 750			≥ 750		
Temperature data						
Ambient temperature (operation)	-20°C ... 70°C			-10°C ... 60°C		
	Ordering data			Ordering data		
Description	Type	Order No.	Pcs./Pkt.	Type	Order No.	Pcs./Pkt.
RJ45 Freenet socket insert , 8-pos., shielded, with cable connection						
10 Gbps, CAT6 _A	CUC-F-J1ZNI-S/R4IDC8	1418984	1	CUC-F-J1ZNI-S/R4IDC8	1418984	1
RJ45 Freenet socket insert , 8-pos., shielded, with cable connection						
1 Gbps, CAT5	VS-08-BU-RJ45-5-F/PK	1652936	1	VS-08-BU-RJ45-5-F/PK	1652936	1
RJ45 Freenet socket insert , 8-pos., shielded, female to female						
1 Gbps, CAT6	CUC-F-D1ZNI-S/R4GC8	1419022	1	CUC-F-D1ZNI-S/R4GC8	1419022	1
RJ45 Freenet panel mounting frame , Version 14, IP65/IP67, for rectangular mounting cutout, with seal, without mounting screws						
Metal housing	VS-PPC-F1-RJ45-MNNA-1R-F	1405358	1			
RJ45 Freenet panel mounting frame , Version 14, IP65/IP67, for round mounting cutout, with seal and central nut						
Metal housing				VS-PPC-F1-RJ45-MNNA-1C-F	1405222	1
RJ45 panel mounting frame with socket insert, Version 14, IP65/IP67, for rectangular mounting cutout, with seal and mounting screws, 8-pos., shielded, with cable connection, CAT6 _A						
Zinc die-cast housing	CUC-V14-F1ZNI-EM/R4F8	1413961	1			
RJ45 panel mounting frame with socket insert, Version 14, IP65/IP67, for rectangular mounting cutout, with seal and mounting screws, 8-pos., shielded, female to female, CAT6						
Zinc die-cast housing	CUC-V14-F1ZNI-EM/R4B8	1413962	1			
Adapter , zinc die-cast						
45°	CUC-V14-A1ZNI-R45	1413988	1			
180°	CUC-V14-A1ZNI-S180	1413989	1			
	Accessories			Accessories		
Protective cover , for data port	VS-PPC-C1-PC-ROBK-L	1405293	1	VS-PPC-C1-PC-ROBK-L	1405293	1
Stripping tool , for multiple-stage repositioning of shielded conductors	VS-CABLE-STRIP-VARIO	1657407	1	VS-CABLE-STRIP-VARIO	1657407	1
Adapter , with filler plug and marking element	CUC-V14-A1RBK-PC	1413985	1			
Marking element , without filler plug	CUC-V14-A1PBK-BA:50	1413979	50			
Protective cover , with spring lid	CUC-V14-A1PBK-PC	1413970	1			
Screw set , M3x20 V2A, including plastic washers, toothed lock washers, and nuts	CUC-V14-A-SCREW-M3:20	1413987	20			
Strain relief plate	CUC-V14-A3ST-SR	1413990	1			

Field couplings,
IP65/67



RJ45 and power field coupling
with cable connection



RJ45 field coupling
with cable connection

	Technical data			Technical data		
Electrical data	VS-MP-PPC/CG-PO/10G			VS-MP-PPC/CG-10G		
Transmission characteristics (category)	CAT6 _A			CAT6 _A		
Material data	Aluminum press-drawn section / die-cast zinc			Aluminum press-drawn section / die-cast zinc		
Connection data	Spring connection / IDC			IDC		
Connection method	-			-		
Connection cross section AWG	5 mm ... 8 mm (Data cable gland)			5 mm ... 8 mm (Data cable gland)		
Cable diameter	> 1000 (Data)			> 1000 (Data)		
Insertion/withdrawal cycles	-			-		
Temperature data	-40°C ... 70°C			-40°C ... 70°C		
Ambient temperature (operation)						
	Ordering data			Ordering data		
Description	Type	Order No.	Pcs./Pkt.	Type	Order No.	Pcs./Pkt.
Multi-port connection , for passive PROFINET cabling to robots, including mounting foot, for cable diameter : 1 Gbps 10 Gbps Multi-port power connection : push-pull power, for passive PROFINET cabling to robots, including mounting foot	VS-MP-PPC/PPC-PO/1G	1406395	1	VS-MP-PPC/CG-10G	1403678	1
	VS-MP-PPC/CG-PO/10G	1403682	1			
	VS-MP-PPC/CG-PO	1403681	1			
	Accessories			Accessories		
Protective cover for data port	VS-PPC-C1-PC-ROBK-L	1405293	1	VS-PPC-C1-PC-ROBK-L	1405293	1
Stripping tool, for multiple-stage repositioning of shielded conductors	VS-CABLE-STRIP-VARIO	1657407	1	VS-CABLE-STRIP-VARIO	1657407	1

Power and data field couplings, IP65/67

- Fixed mounting is also an option
- Robust design
- Including covers to protect against environmental influences



RJ45 and power field coupling

ERC

Technical data

Electrical data	VS-MP-PPC/PPC-1G
Rated voltage	72 V (DC)
Rated current	-
Transmission characteristics (category)	CAT5
Material data	
Housing material	Aluminum press-drawn section / die-cast zinc
Contact material	Phosphor bronze
Flammability rating in accordance with UL 94	V0
Mechanical data	
Number of positions	8
Degree of protection	IP65
Temperature data	
Ambient temperature (operation)	-40°C ... 70°C

Ordering data

Description	Type	Order No.	Pcs./Pkt.
Multi-port data coupling: for passive PROFINET cabling to robots, including mounting foot	VS-MP-PPC/PPC-1G	1403685	1
Metal housing			
Multi-port power coupling: for passive PROFINET cabling to robots, including mounting foot	VS-MP-PPC/PPC-PO	1403684	1

**Terminal outlets,
IP65/67**

- Easy installation, thanks to captive cover screws
- Robust design
- Including covers to protect against environmental influences
- Integrated cable management system



**Terminal outlet
with 2 x RJ45 slots**



**Terminal outlet
with RJ45 and power slots**

ERIC

Technical data	
Electrical data	
Rated voltage	72 V (DC)
Rated current	-
Transmission characteristics (category)	CAT6
Material data	
Housing material	Aluminum cast alloy, powder-coated
Mechanical data	
Color	black
Degree of protection	IP65/IP67

Ordering data		
Type	Order No.	Pcs./Pkt.
Terminal outlet, IP65/IP67, 2 slots, Version 14, with protective plugs, 2 cable entries		
Push-pull with 2 x RJ45		
Terminal outlet, IP65/IP67, 2 slots, Version 14, with protective plugs, 2 cable entries	VS-TO-RO-MCBK-F1411/1411	1404281
Push-pull with 1 x Power and 1 x RJ45		

ERIC

Technical data	
Electrical data	
Rated voltage	72 V (DC)
Rated current	-
Transmission characteristics (category)	CAT6
Material data	
Housing material	Aluminum cast alloy, powder-coated
Mechanical data	
Color	black
Degree of protection	IP65/IP67

Ordering data		
Type	Order No.	Pcs./Pkt.
Terminal outlet, IP65/IP67, 2 slots, Version 14, with protective plugs, 2 cable entries		
Push-pull with 1 x Power and 1 x RJ45		
Terminal outlet, IP65/IP67, 2 slots, Version 14, with protective plugs, 2 cable entries	VS-TO-RO-MCBK-F1411/1413	1404333
Push-pull with 1 x Power and 1 x RJ45		

Push-pull power connectors, IP65/IP67

- Fixed coding for PROFINET
- Flexible coding
- Various solder versions
- Spring connection



Push-pull connector



Push-pull panel mounting side



Technical data			Technical data			
Electrical data	CUC-PPC-C2ZNI-S.../24FKP5		VS-MSTBA...-BK-A	VS-PPC-F2-MSTB-MNNA...		
Rated current	16 A (at 20°C)		16 A	-		
Material data						
Housing material	Zinc die-cast		-	Zinc die-cast		
Flammability rating in accordance with UL 94	V0		V0	V0		
Conductor cross section	0.75 mm ² ... 2.5 mm ²		-	-		
Connection cross section AWG	18 ... 13		-	-		
Insertion/withdrawal cycles	≥ 100		≥ 100	≥ 500		
Temperature data						
Ambient temperature (operation)	-40°C ... 85°C		-40°C ... 70°C	-40°C ... 80°C		
Ordering data			Ordering data			
Description	Type	Order No.	Pcs./Pkt.	Type	Order No.	Pcs./Pkt.
MSTB connector, IP67 , with push-pull interlocking, 5-pos., with spring connection, metal housing, 24 V, molded coding						
for cable diameter of 6.5 mm ... 9 mm	CUC-PPC-C2ZNI-SX/24FKP5	1421783	1			
for cable diameter of 9 mm ... 13 mm	CUC-PPC-C2ZNI-SS/24FKP5	1421785	1			
MSTB connector, IP67, without logo , with push-pull locking, 5-pos., with spring connection, metal housing, 24 V, molded coding						
for cable diameter of 9 mm ... 13 mm	CUC-PPC-C2ZNI-SX/24FKP5:WO	1032276	1			
MSTB connector, IP67 , with push-pull interlocking, 5-pos., with spring connection, metal housing, 24 V, variable coding						
for cable diameter of 6.5 mm ... 9 mm	CUC-PPC-C2ZNI-SS/24FKP5:FC	1425515	1			
for cable diameter of 9 mm ... 13 mm	CUC-PPC-C2ZNI-SX/24FKP5:FC	1425514	1			
MSTB connector, IP67, without logo , with push-pull locking, 5-pos., with spring connection, metal housing, 24 V, variable coding						
for cable diameter of 9 mm ... 13 mm	CUC-PPC-C2ZNI-SX/24FKP5:FCWO	1032275	1			
Blind plug , for MSTB connectors	CUC-PPC-C2ZNI-DC	1001432	1			
MSTB contact insert , for PCB mounting, 24 V, 5-pos., RAL 9005 (black), for panel mounting frame VS-PPC-F2-MSTB-...-1R-P				VS-MSTBAH 2,5/ 5-GB-5,08-BK-A	1657915	50
Angled solder pins				VS-MSTBVA 2,5/ 5-GB-5,08-BK-A	1609565	50
Straight solder pins						
MSTB panel mounting frame, IP67 , for Push-Pull locking, for PCB connection, for rectangular assembly opening, with gasket, without mounting screws						
Metal housing				VS-PPC-F2-MSTB-MNNA-1R-P	1608087	1
MSTB panel mounting frame, IP67 , for push-pull interlocking, with integrated contact insert for conductor connection, spring connection, for rectangular mounting cutout, with seal, without mounting screws						
24 V, metal				VS-PPC-F2-MSTB-MNNA-1R-SPSA5	1608249	1
MSTB panel mounting frame, IP67 , for push-pull interlocking, metal, with integrated contact insert for conductor connection, spring connection, for round mounting cutout, with seal, without mounting screws						
24 V				VS-PPC-F2-MSTB-MNNA-1C-SPSA5	1405248	1
Protective cover , for MSTB panel mounting frame				CUC-PPC-A2RBK-PC	1424989	1
Protective cap, IP65 , with push-pull locking for covering the contact insert in the push-pull connector for Power, plastic						
				VS-PPC-F2-PC-POBK	1405329	1

Push-pull power distributors, IP65/IP67



Push-pull Y-distributor



Push-pull H-distributor

ERIC

Technical data

Electrical data	VS-PPC-J-1220-1227-1020-0,2
Rated voltage	24 V
Rated current	16 A
Material data	
Housing material	Aluminum die-cast
Mechanical data	
Number of positions	5
Degree of protection	IP65/IP67
Temperature data	
Ambient temperature (operation)	-40°C ... 70°C (cable, fixed installation)

Ordering data

Description	Type	Order No.	Pcs./Pkt.
PROFINET Y-distributor with assembled power cable, 5-pos., IP65/IP67, MSTB connector with metal housing to 2 x socket in the metal housing, cable length:			
0.2 m	VS-PPC-J-1220-1227-1020-0,2	1404799	1
Variable	VS-PPC-J-1220-1227-1020-...	1405484	1
Power H distributor , 4 x MSTB contact inserts, metal housing, without mounting screws			

Accessories

Description	Type	Order No.	Pcs./Pkt.
Mounting foot for power distributors, plastic	VS-PPC-J-M	1405390	1

ERIC

Technical data

Electrical data	VS-PPC-J-4X-1227
Rated voltage	24 V
Rated current	16 A (at 20°C)
Material data	
Housing material	Zinc die-cast
Mechanical data	
Number of positions	5
Degree of protection	IP65/IP67
Temperature data	
Ambient temperature (operation)	-40°C ... 85°C

Ordering data

Description	Type	Order No.	Pcs./Pkt.
Power H distributor , 4 x MSTB contact inserts, metal housing, without mounting screws			
	VS-PPC-J-4X-1227	1405387	1

Accessories

Description	Type	Order No.	Pcs./Pkt.
Mounting foot for power distributors, plastic	VS-PPC-J-M	1405390	1

Ordering example for products with variable cable length:

For a distributor with a cable length of 34.5 m,
the ordering data is as follows:

Order No.	Length [m]
1405484	34.5
	Increment: 0.5 m
	Maximum length: 50 m

Data connectors and cables

Network components – version 14 connectors

Assembled power cables 2.5 mm²

Power, metal, 24 V
2.5 mm²

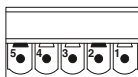

Ordering data

Power, metal, 24 V, 2.5 mm²

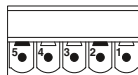

Order No.

1609170

1609183

1609196

Variable

1609206

Ordering example for cables with variable cable length:

Assembled PROFINET power cable for 24 V, with two metal push-pull connectors and a cable length of 34.5 m.

Order No.	Length [m] Max. 100 m
1609206	34.5
Increments: 1.0 m ... 3.0 m = 0.1 m > 3.0 m = 0.5 m	

Technical data

Technical data		Power, metal, 24 V 1.5 mm ²
Housing material		Zinc die-cast
Outer sheath, material		PVC
Conductor cross section	[mm ²]	2.5
External cable diameter	[mm]	11.8
Degree of protection		IP65
Ambient temperature		
Fixed installation	[°C]	-40 ... 70
Flexible installation	[°C]	-5 ... 70
Male connector/female connector	[°C]	-40 ... 70

**Push-Pull ADVANCE connectors,
IP65/IP67**

- Easy handling, thanks to one-piece design
- Locking system to prevent unintentional removal



SC-RJ connector, cable outlet straight,
for polymer fibers 980 / 1000 µm



SC-RJ connector, cable outlet at the top,
for polymer fibers 980 / 1000 µm

ERIC®

Technical data

Degree of protection	IP65/IP67
Housing material	Zinc die-cast
External cable diameter	5.5 mm ... 10 mm
Insertion/withdrawal cycles	≥ 100
Temperature data	
Ambient temperature (operation)	-25°C ... 70°C

Degree of protection	IP65/IP67
Housing material	Zinc die-cast
External cable diameter	5.5 mm ... 10 mm
Insertion/withdrawal cycles	≥ 100
Temperature data	
Ambient temperature (operation)	-25°C ... 70°C

Ordering data

Type	Order No.	Pcs./Pkt.
FOC-V14-C1ZNI-S/SJFP	1407896	1

Type	Order No.	Pcs./Pkt.
FOC-V14-C1ZNI-T/SJFP	1408028	1

Accessories

Tool set for POF assembly, for field installation of SC connectors.	TF-SCRJ-POF KONF SET	1405246	1
---	----------------------	---------	---

Tool set for POF assembly, for field installation of SC connectors.	TF-SCRJ-POF KONF SET	1405246	1
---	----------------------	---------	---

ERIC®

Technical data

Degree of protection	IP65/IP67
Housing material	Zinc die-cast
External cable diameter	5.5 mm ... 10 mm
Insertion/withdrawal cycles	≥ 100
Temperature data	
Ambient temperature (operation)	-25°C ... 70°C

Ordering data

Type	Order No.	Pcs./Pkt.
FOC-V14-C1ZNI-T/SJFP	1408028	1

Accessories

Tool set for POF assembly, for field installation of SC connectors.	TF-SCRJ-POF KONF SET	1405246	1
---	----------------------	---------	---

Push-Pull ADVANCE connectors, IP65/IP67



SC-RJ connector, cable outlet at the bottom,
for polymer fibers 980 / 1000 µm

ERC®

Technical data

Degree of protection	IP65/IP67
Housing material	Zinc die-cast
External cable diameter	5.5 mm ... 10 mm
Insertion/withdrawal cycles	≥ 100
Temperature data	
Ambient temperature (operation)	-25°C ... 70°C

Ordering data

Description	Type	Order No.	Pcs./Pkt.
Push-pull ADVANCE, SC-RJ connector Single pack	FOC-V14-C1ZNI-B/SJFP	1407902	1

Accessories

Tool set for POF assembly, for field installation of SC connectors.	TF-SCRJ-POF KONF SET	1405246	1
---	----------------------	---------	---

FO connectors, panel mounting frames, and couplings



SC-RJ panel mounting side

ERC

Technical data

Housing material	Zinc die-cast
Flammability rating in accordance with UL 94	V0
Degree of protection	IP65/IP67
Insertion/withdrawal cycles	≥ 50
Temperature data	
Ambient temperature (operation)	-40°C ... 70°C

Ordering data

Description	Type	Order No.	Pcs./Pkt.
SC-RJ panel mounting frame, IP67 , for push-pull interlocking, for rectangular mounting cutout, for AVAGO transceiver (type: AFBR5978BZ) on PCB, with seal and mounting screws			
Zinc die-cast housing SC-RJ panel mounting frame, IP67, incl. SC-RJ coupling , for push-pull interlocking, for rectangular mounting cutout, with seal and mounting screws	FOC-V14-F1ZNI-EM/SJO	1413981	1
Zinc die-cast housing SC-RJ panel mounting frame, IP67, incl. SC-RJ coupling , for push-pull interlocking, for round mounting cutout, with seal	FOC-V14-F1ZNI-EM/SJB	1413964	1
Adapter, zinc die-cast	VS-PPC-F1-SCRJ-MNNA-1C-F	1405235	1
45°	CUC-V14-A1ZNI-R45	1413988	1
180°	CUC-V14-A1ZNI-S180	1413989	1

Accessories

Protective cover , for data port	VS-PPC-C1-PC-ROBK-L	1405293	1
Adapter , with filler plug and marking element	CUC-V14-A1RBK-PC	1413985	1
Marking element , without filler plug	CUC-V14-A1PBK-BA:50	1413979	50
Protective cover , with spring lid	CUC-V14-A1PBK-PC	1413970	1
Screw set , M3x20 V2A, including plastic washers, toothed lock washers, and nuts	CUC-V14-A-SCREW-M3:20	1413987	20

Power and data field couplings, IP65/67



SC-RJ and power field coupling with cable connection



SC-RJ field coupling with cable connection

Material data
Housing material
Connection data
Connection profile
Insertion/withdrawal cycles
Temperature data
Ambient temperature (operation)

Technical data	
VS-MP-PPC/CG-PO/FO	VS-MP-PPC/CG-PO
Aluminum press-drawn section / die-cast zinc	Aluminum press-drawn section / die-cast zinc
Data/power: SCRJ/5-pos. ≥ 500 (Data)	Power: 5-pos. ≤ 100 (Power)
-40°C ... 70°C	-40°C ... 70°C

Technical data	
VS-MP-PPC/CG-FO	
Aluminum press-drawn section / die-cast zinc	
Data: SCRJ ≥ 500 (Data)	
-40°C ... 70°C	

Description
Multi-port connection , for passive PROFINET cabling to robots, including mounting foot
Multi-port power connection , push-pull power, for passive PROFINET cabling to robots, including mounting foot
Multi-port power coupling , for passive PROFINET cabling to robots, including mounting foot

Ordering data		
Type	Order No.	Pcs./Pkt.
VS-MP-PPC/CG-PO/FO	1404321	1
VS-MP-PPC/CG-PO	1403681	1
VS-MP-PPC/PPC-PO	1403684	1

Ordering data		
Type	Order No.	Pcs./Pkt.
VS-MP-PPC/CG-FO	1404319	1

Protective cover for data port
Stripping tool , for multiple-stage repositioning of shielded conductors

Accessories		
VS-PPC-C1-PC-ROBK-L	1405293	1
VS-CABLE-STRIP-VARIO	1657407	1

Accessories		
VS-CABLE-STRIP-VARIO	1657407	1

Terminal outlets and couplings, IP65/67

- Easy installation, thanks to captive cover screws
- Robust design
- Including covers to protect against environmental influences
- Integrated cable management system



Terminal outlet with SC-RJ and power slots



SC-RJ field coupling

ERIC

ERIC®

Technical data		
Material data	Aluminum cast alloy, powder-coated	
Housing material		
Connection data		
Connection profile	-	
Insertion/withdrawal cycles	-	
Temperature data		
Ambient temperature (operation)	-40°C ... 70°C	
Ordering data		
Type	Order No.	Pcs./Pkt.
Terminal outlet SC-RJ/Power IP65/67 Push-Pull, 2 slots version 14, with protective plugs, 2 cable entries	VS-TO-RO-MCBK-F1417/1413	1404346 1
Terminal outlet SC-RJ IP65/67 Push-Pull, 2 slots version 14, with protective plugs, 2 cable entries	VS-TO-RO-MCBK-F1417/1417	1404320 1

Technical data		
Material data	Zinc die-cast	
Housing material		
Connection data		
Connection profile	-	
Insertion/withdrawal cycles	≥ 500	
Temperature data		
Ambient temperature (operation)	-40°C ... 70°C	
Ordering data		
Type	Order No.	Pcs./Pkt.
SC-RJ push/pull coupling, IP67, metal, with protective cover, color: nickel-plated	VS-PPC-J-1-SCRJ-MNBK	1405206 1

RJ45 connectors, IP20



RJ45 crimp connectors



RJ45 field connection connectors

ERC

ERC

	Technical data	
	VS-08-RJ45-10G/C	VS-08-ST-H21P-RJ45
Electrical data		
Transmission characteristics (category)	CAT6 _A	-
Overvoltage category	I	I
Material data		
Housing material	-	-
Contact material	Phosphor bronze	Copper alloy
Flammability rating in accordance with UL 94	V2	V2
Degree of pollution	-	2
External cable diameter	-	-
Insertion/withdrawal cycles	≥ 750	≥ 750
Temperature data		
Ambient temperature (operation)	-25°C ... 60°C	-25°C ... 60°C

	Technical data	
	VS-08-RJ45-5-Q/IP20...	CUC-STD-C1P..
Electrical data		
Transmission characteristics (category)	CAT5 (IEC 11801:2002)	CAT6
Overvoltage category	I	-
Material data		
Housing material	PA	PA
Contact material	Cu/Sn	Phosphor bronze
Flammability rating in accordance with UL 94	V0	V2
Degree of pollution	1	2
External cable diameter	4.5 mm ... 8 mm	7 mm
Insertion/withdrawal cycles	≥ 1000	≥ 750
Temperature data		
Ambient temperature (operation)	-20°C ... 70°C	-25°C ... 60°C

	Ordering data		
Description	Type	Order No.	Pcs./Pkt.
RJ45 connector , IP20, CAT5, 8-pos., with QUICKON fast connection technology, for 1-wire and 7-wire 26 to 23 AWG conductors, color: gray black			
RJ45 connector , IP20, CAT6 _A , 8-pos., with QUICKON fast connection technology, for 26 ... 24 AWG 1-wire and 7-wire conductors, color: black			
RJ45 connector , 4-pos., with QUICKON fast connection technology, for 22 AWG, color: gray			
RJ45 connector , IP20, CAT6, 8-pos., with crimp connection, for 27 ... 24 AWG, color: gray green	CUC-STD-C1PGY-S/R4E8:1 CUC-STD-C1PGN-S/R4E8:1	1414382 1414400	1 1
RJ45 connector , IP20, CAT6 _A , 8-pos., with crimp connection, for 27 ... 24 AWG, color: gray green	CUC-STD-C1PGY-S/R4EA:1 CUC-STD-C1PGN-S/R4EA:1	1414395 1414402	1 1
RJ45 male insert , CAT6 _A , 10 Gbps	VS-08-RJ45-10G/C	1418853	5
RJ45 male insert , 8-pos., shielded, IDC connection technology, for 27 ... 26 AWG litz wires, with strain relief			
CAT5	VS-08-ST-H11-RJ45	1652716	5
RJ45 bend protection sleeve , for VS-08-ST-H11-RJ45 and VS-08-RJ45-10G/C male inserts, for cable diameter up to 7 mm, color: gray green	VS-08-KS-H/GY VS-08-KS-H/GN	1654743 1654756	5 5

	Ordering data		
Description	Type	Order No.	Pcs./Pkt.
	VS-08-RJ45-5-Q/IP20 VS-08-RJ45-5-Q/IP20 BK	1656725 1658008	1 1
	VS-08-RJ45-10G/Q	1419001	1
	VS-PN-RJ45-5-Q/IP20	1658435	1

	Accessories		
Crimp tool , pliers with die, for VS-08-ST-H...-RJ45	VS-CT-RJ45-H	1653265	1
Stripping tool , for multiple-stage repositioning of shielded conductors	VS-CABLE-STRIP-VARIO	1657407	1
Shielding foil set , 25 pcs., replacement for VS-PN-RJ45-5-Q/IP20			

	Accessories		
	VS-CABLE-STRIP-VARIO	1657407	1
	VS-08-RJ45-FOLIEN-SET	1417184	1

RJ45 industrial connectors, IP20

- Optimized for industrial use with a high degree of resistance to vibration
- High resistance to ESD and EMI for reliable transmission
- Easy handling, thanks to one-piece design
- Metal locking mechanism



RJ45 industrial, straight cable outlet



RJ45 industrial, cable outlet at the bottom and top



Technical data

Degree of protection	IP20
Connection cross section AWG	26 ... 24 (rigid)
Connection cross section AWG	26 ... 24 (flexible)
Transmission speed	1 Gbps
Housing material	Zinc die-cast
External cable diameter	5 mm ... 9 mm
Insertion/withdrawal cycles	≥ 750
Temperature data	
Ambient temperature (operation)	-40°C ... 70°C

Ethernet	PROFINET
IP20	IP20
26 ... 24 (rigid)	23 ... 22 (rigid)
26 ... 24 (flexible)	23 ... 22 (flexible)
1 Gbps	1 Gbps
Zinc die-cast	Zinc die-cast
5 mm ... 9 mm	5 mm ... 9 mm
≥ 750	≥ 750
-40°C ... 70°C	-40°C ... 70°C



Technical data

Ethernet	PROFINET
IP20	IP20
26 ... 24 (rigid)	23 ... 22 (rigid)
26 ... 24 (flexible)	23 ... 22 (flexible)
1 Gbps	1 Gbps
Zinc die-cast	Zinc die-cast
5 mm ... 9 mm	5 mm ... 9 mm
≥ 750	≥ 750
-40°C ... 70°C	-40°C ... 70°C

Ordering data

Description	Order No.	Pcs./Pkt.	Order No.	Pcs./Pkt.
	Ethernet		PROFINET	
RJ45 industrial connector, 8-pos.	1421607	1	1421126	1
RJ45 industrial connector, 8-pos., cable outlet at the bottom				
RJ45 industrial connector, 8-pos., cable outlet at the top				

Order No.	Pcs./Pkt.	Order No.	Pcs./Pkt.
Ethernet		PROFINET	
1421607	1	1421126	1

Ordering data

Order No.	Pcs./Pkt.	Order No.	Pcs./Pkt.
Ethernet		PROFINET	
1421877	1	1421128	1
1421876	1	1421127	1

Accessories

Stripping tool , for multiple-stage repositioning of shielded conductors	VS-CABLE-STRIP-VARIO	1657407	1
Electronic diagonal cutter , tapered head, without chamfer, with opening spring, non-reflective phosphate-treated surface, punched version	MICROFOX-SP-1	1212487	1
Markers for terminal blocks, roll , unmarked, can be marked with: THERMOMARK ROLL, THERMOMARK X, THERMOMARK S1.1 white	TMT 5 R	0816430	1
Marker for terminal blocks, sheet , white, unmarked, can be marked with: BLUEMARK CLED, BLUEMARK LED, plotter	UC-TMF 5	0818153	10

VS-CABLE-STRIP-VARIO	1657407	1
MICROFOX-SP-1	1212487	1
TMT 5 R	0816430	1
UC-TMF 5	0818153	10

Accessories

VS-CABLE-STRIP-VARIO	1657407	1
MICROFOX-SP-1	1212487	1
TMT 5 R	0816430	1
UC-TMF 5	0818153	10

RJ45 panel mounting frames and inserts, IP20



Keystone panel mounting frame and keystones

ERC

Technical data

Electrical data	VS-08-BU-RJ45-6/KA/LSA
Rated current	2 A
Transmission characteristics (category)	CAT6
Material data	
Housing material	PC+ABS
Contact material	Phosphor bronze
Flammability rating in accordance with UL 94	V0
Mechanical data	
Number of positions	8
Connection method	LSA
Conductor cross section	0.13 mm ² ... 0.25 mm ² (rigid)
Connection cross section AWG	26 ... 23 (rigid)
Temperature data	
Ambient temperature (operation)	-20°C ... 70°C

Ordering data

Description	Type	Order No.	Pcs./Pkt.
RJ45 socket insert , 8-pos., shielded, female to female			
CAT5	VS-08-BU-RJ45/BU	1689064	5
RJ45 socket insert , 8-pos., shielded, female to female			
CAT6	VS-08-BU-RJ45-6-MOD/BU	1653155	5
RJ45 socket insert , 8-pos., shielded, with cable connection			
CAT6 _A	CUC-K-J1ZNI-S/R4IDC8	1419021	1
RJ45 panel mounting frame , single, for modular female inserts (Keystone), without mounting screws			
	VS-08-A-RJ45/MOD-1-IP20	1689433	5

Accessories

Stripping tool , for multiple-stage repositioning of shielded conductors	VS-CABLE-STRIP-VARIO	1657407	1
---	----------------------	---------	---

DIN rail adapters

new



DIN rail adapter



DIN rail adapter housing, inserts

ERC

	Technical data			Technical data		
Electrical data	FL-PP-RJ45-...			FOC-I-D1PGN-S/...	CUC-I-...1ZNI-S/R4...	
Transmission characteristics (category)	CAT6			-	CAT6 _A	
Material data						
Housing material	PC-GF			PBT	Zinc die-cast	
Contact material	CuSn			-	CuSn	
Flammability rating in accordance with UL 94	V0			V0	-	
Mechanical data						
Number of positions	8			-	8	
Color	gray			-	-	
Degree of protection	IP20			IP20	IP20	
Connection method	Coupling			Coupling	IDC connection	
Connection cross section AWG	-			-	26 ... 22 (rigid)	
Temperature data						
Ambient temperature (operation)	-10°C ... 60°C			-10°C ... 70°C	-25°C ... 70°C	
	Ordering data			Ordering data		
Description	Type	Order No.	Pcs./Pkt.	Type	Order No.	Pcs./Pkt.
DIN rail adapter , IP20, coupler module						
CAT6 for 1 Gbps	CUC-PP-D1PGY/R4GC8	1418094	1			
DIN rail adapter , IP20, CAT6 _A , connection cross section: 26 ... 22 AWG						
CAT6 _A for 10 Gbps	CUC-PP-D1PGY/R4IDC8	1419024	1			
DIN rail adapter , patch panel, SC-RJ, IP20, female/female, can be used with glass, multimode, HCS, and polymer fibers						
	VS-PP-F-SCRJ	1658121	1			
DIN rail adapter housing						
Insert , for DIN rail adapter housings				NBC-PP-G1PGY	1041740	1
LC duplex coupling				FOC-I-D1PGN-S/LCGCSM	1041780	1
SC simplex coupling				FOC-I-D1PGR-S/SCGCSM	1041800	1
MTP coupling, type A				FOC-I-D1PGY-S/MPAGC	1041820	1
MTP coupling, type B				FOC-I-D1PGY-S/MPBGC	1041840	1
RJ45 female insert, CAT6 _A				CUC-I-J1ZNI-S/R4IDC8	1417274	1
RJ45 coupling, CAT6 _A				CUC-I-D1ZNI-S/R4GC8	1041760	1
	Accessories			Accessories		
Plug Guard Security frame , white, for DIN rail adapters, for securing the RJ45 interface against unauthorized disconnection, with key element						
Dust protection flap , gray, for DIN rail adapters				NBC-PP-F1PWH:10	1041881	10
Port Guard Security element , red, for securing the RJ45 interface against unauthorized access, with key element				NBC-PP-P1PGY:10	1041860	10
				NBC-PP-A1PRD:10	1041900	10

FO connectors, IP20



POF, 980/1000 μm



PCF, 200/230 μm, 2.9 mm

ERC

Technical data

Material data
Housing material
Ferrule material
Flammability rating in accordance with UL 94
Color
Degree of protection
Insertion/withdrawal cycles
Temperature data
Ambient temperature (operation)

PBT
Copper alloy
V0
black
IP20
≥ 500
-25°C ... 70°C

Ordering data

Description
FO connector SC-RJ, duplex, with fast connection
IP20
IP20, for single wire diameter: 2.9 mm
FO connector for 200/230 μm PCF fibers, crimp connection
- SC-RJ
- SC duplex
Connector set for polymer fibers (diameter of the individual elements: 2.2 mm), for self-assembly, with bend protection
- F-SMA set, 4 connectors
Connector set for PCF fibers (diameter of the individual elements: 2.9 mm), for self-assembly, with bend protection
- F-SMA set, 4 connectors
- B-FOC (ST®) set, 4 connectors
Connector set for PROFINET PCF fibers (diameter of the individual elements: 2.2 mm), for self-assembly, with bend protection
- SC duplex set, 2 duplex connectors
- B-FOC (ST®) set, 4 connectors

Type	Order No.	Pcs./Pkt.
VS-SCRJ-POF-FA-IP20	1654879	1
PSM-SET-FSMA/4-KT	2799720	1

Accessories

Tool set for POF assembly , for field installation of SC connectors.
Tool set for PCF assembly , for field installation of SC connectors
PCF (GI) DIY case for SC-RJ and SC duplex quick mounting connectors, stripping blade, stripping pliers, aramid yarn scissors, fiber stripper, fiber cleaving tool, and microscope

TF-SCRJ-POF KONF SET	1405246	1
----------------------	---------	---

ERC

Technical data

PBT
Copper alloy
V0
black
IP20
≥ 1000
-20°C ... 70°C

Ordering data

Type	Order No.	Pcs./Pkt.
VS-SCRJ-HCS-FA-IP20	1654866	1
PSM-SET-FSMA/4-HCS	2799487	1
PSM-SET-B-FOC/4-HCS	2708481	1

Accessories

--	--	--



PCF, 200/230 μm, 2.2 mm



PCF, 200/230 μm

ERC

ERC

Technical data
PBT
Copper alloy
V0
black
IP20
≥ 1000
-20°C ... 70°C

Technical data
PBT
Zirconia ceramics
V0
beige
IP20
≥ 500
-40°C ... 70°C

Ordering data		
Type	Order No.	Pcs./Pkt.
PSM-SET-SC-DUPLEX/2-HCS/PN	2313779	1
PSM-SET-B-FOC/4-HCS/PN	2313782	1

Ordering data		
Type	Order No.	Pcs./Pkt.
FOC-C-SCRJ-PCF	1411304	1
FOC-C-SCDU-PCF	1411305	1

Accessories		
Type	Order No.	Pcs./Pkt.
PSM-HCS-KONFTOOL/SC-RJ	2708876	1

Accessories		
Type	Order No.	Pcs./Pkt.
FOC-TOOL-PCF KONF SET	1411051	1
PSM-HCS-KONFTOOL/SC-RJ	2708876	1

Network components – IP20 connectors

FO connectors, IP20, field connection

- Cleave technology
- Reusable connectors
- Optimum attenuation values with easy assembly
- No bonding or polishing



LC duplex connector,
1.25 mm - ferrules



LC simplex connector for pigtails,
1.25 mm - ferrules

ERC

Technical data

Material data
Housing material
Ferrule material
Flammability rating in accordance with UL 94
Color
Degree of protection
Insertion/withdrawal cycles
Temperature data
Ambient temperature (operation)

PBT
Zirconia ceramics
V0
beige
IP20
≥ 500 (in accordance with IEC 61300-2-2)
-10°C ... 60°C (IEC 61300-2)

Ordering data

Description
FO connector, fast connection, reusable
GOF, 50/125 μm, multimode
GOF, 9/125 μm, single mode (APC)
GOF, 9/125 μm, single mode (PC)
FO connector, fast connection, reusable, value pack
GOF, 50/125 μm, multimode
GOF, 9/125 μm, single mode (APC)
GOF, 9/125 μm, single mode (PC)

Type	Order No.	Pcs./Pkt.
FOC-C-LCDU-GOF-MM	1411052	1
FOC-C-LCDU-GOF-SM-APC	1412472	1
FOC-C-LCDU-GOF-SM-PC	1411053	1
FOC-C-LCDU-GOF-MM/10	1411298	1
FOC-C-LCDU-GOF-SM-APC/10	1412479	1
FOC-C-LCDU-GOF-SM-PC/10	1411299	1

Accessories

Tool set for GOF assembly, for field installation of LC and SC connectors
--

FOC-TOOL-GOF KONF SET	1411049	1
-----------------------	---------	---

ERC

Technical data

-
Zirconia ceramics
V0
beige
IP20
≥ 500 (in accordance with IEC 61300-2-2)
-10°C ... 60°C (IEC 61300-2)

Ordering data

Type	Order No.	Pcs./Pkt.
FOC-C-LC:P-GOF-MM	1411294	1
FOC-C-LC:P-GOF-SM-APC	1412476	1
FOC-C-LC:P-GOF-SM-PC	1411295	1
FOC-C-LC:P-GOF-MM/10	1411294	1
FOC-C-LC:P-GOF-SM-APC/10	1412476	1
FOC-C-LC:P-GOF-SM-PC/10	1411295	1

Accessories

FOC-TOOL-GOF KONF SET	1411049	1
-----------------------	---------	---



SC duplex connector,
2.5 mm - ferrules



SC simplex connector for pigtailed,
2.5 mm - ferrules



SC-RJ connector,
2.5 mm - ferrules

ERC

ERC

ERC

Technical data		
-		
Zirconia ceramics		
V0		
green		
IP20		
≥ 500 (in accordance with IEC 61300-2-2)		
-10°C ... 60°C (IEC 61300-2)		
Ordering data		
Type	Order No.	Pcs./Pkt.
FOC-C-SCDU-GOF-MM	1411292	1
FOC-C-SCDU-GOF-SM-APC	1412474	1
FOC-C-SCDU-GOF-SM-PC	1411293	1
FOC-C-SCDU-GOF-MM/10	1411302	1
FOC-C-SCDU-GOF-SM-APC/10	1412481	1
FOC-C-SCDU-GOF-SM-PC/10	1411303	1
Accessories		
FOC-TOOL-GOF KONF SET	1411049	1

Technical data		
-		
Zirconia ceramics		
V0		
blue		
IP20		
≥ 500 (in accordance with IEC 61300-2-2)		
-10°C ... 60°C (IEC 61300-2)		
Ordering data		
Type	Order No.	Pcs./Pkt.
FOC-C-SC:P-GOF-MM	1411296	1
FOC-C-SC:P-GOF-SM-APC	1412478	1
FOC-C-SC:P-GOF-SM-PC	1411297	1
Accessories		
FOC-TOOL-GOF KONF SET	1411049	1

Technical data		
-		
Zirconia ceramics		
V0		
beige		
IP20		
≥ 500 (in accordance with IEC 61300-2-2)		
-10°C ... 60°C (IEC 61300-2)		
Ordering data		
Type	Order No.	Pcs./Pkt.
FOC-C-SCRJ-GOF-MM	1411290	1
FOC-C-SCRJ-GOF-SM-APC	1412473	1
FOC-C-SCRJ-GOF-SM-PC	1411291	1
FOC-C-SCRJ-GOF-MM/10	1411300	1
FOC-C-SCRJ-GOF-SM-APC/10	1412480	1
FOC-C-SCRJ-GOF-SM-PC/10	1411301	1
Accessories		
FOC-TOOL-GOF KONF SET	1411049	1

Fiber optic couplings

Suitable for fiber types:

- POF (980/1000 μm), PCF (200/230 μm), GOF MM (50/125 μm), GOF SM (9/125 μm)



SC-RJ coupling



Couplings for connecting FO cables

ERC

Technical data

Material data	
Housing material	PBT
Ferrule material	Zirconia ceramics
Flammability rating in accordance with UL 94	V0
Color	black
Degree of protection	IP20
Insertion/withdrawal cycles	≥ 500
Temperature data	
Ambient temperature (operation)	-25°C ... 70°C

Ordering data

Description	
SC-RJ coupling , for terminal outlets VS-TO-... and 19" patch panels VS-PP-19-1HE-16-F and front plate VS-SI-FP-2F	
1x SC-RJ (duplex)	
Coupling ; set, consisting of:	
2 x F-SMA/F-SMA	
2 x B-FOC (ST®)/B-FOC (ST®)	
1x SC-RJ/SC-RJ (duplex)	
1 x LC/LC (duplex, multimode fiber)	
1x LC/LC (duplex, single-mode fiber (PC))	
1x SC duplex/SC duplex	

Type	Order No.	Pcs./Pkt.
VS-SCRJ-GOF-KU	1654358	1

ERC

Technical data

	-
	-
	V0
	bare metallic
	IP20
	-
	-25°C ... 85°C

Ordering data

Type	Order No.	Pcs./Pkt.
PSM-SET-FSMA-LINK/2	2799416	1
PSM-SET-BFOC-LINK/2	2799429	1
VS-SCRJ-GOF-BU/BU	1652978	1
FL MM PATCH COUPLER LC-LC	2700312	1
FL SM PATCH COUPLER LC-LC	2700313	1
FL COUPLER SC-DUPLEX	2901788	1

FO splice boxes, FDX 20 series, IP20

- Compact dimensions despite large splice comb
- Snap-in adapter for easy DIN rail mounting
- Ready for equipotential bonding
- Suitable for industrial applications
- Up to twelve duplex front connections
- Preassembly ready for splicing
- Intuitive front operation



new

FDX 20 splice box,
DIN rail mounting

Technical data			
Material data			
Housing material	Sheet steel		
Ferrule material	Zirconia ceramics		
Flammability rating in accordance with UL 94	V0		
Color	traffic gray A RAL 7042		
Degree of protection	IP20		
Insertion/withdrawal cycles	≥ 500		
Temperature data			
Ambient temperature (operation)	-40°C ... 85°C		
Ordering data			
Description	Type	Order No.	Pcs./Pkt.
DIN rail splice box , for 6 x LC duplex			
Without pigtails	FOC-FDX20-PP-LCD6-MM	1019710	1
OM2 (G50 / 125 µm)	FOC-FDX20-PP-LCD6-OM2-PT9	1019713	1
OM4 (G50 / 125 µm)	FOC-FDX20-PP-LCD6-OM4-PT9	1019712	1
OS2 (PC) (E9 / 125 µm)	FOC-FDX20-PP-LCD6-OSP-PT9	1019711	1
OS2 (APC) (E9 / 125 µm)	FOC-FDX20-PP-LCD6-OSA-PT9	1083665	1
DIN rail splice box , for 12 x LC duplex			
Without pigtails	FOC-FDX20-PP-LCQ6-MM	1019705	1
OM2 (G50 / 125 µm)	FOC-FDX20-PP-LCQ6-OM2-PT9	1019709	1
OM4 (G50 / 125 µm)	FOC-FDX20-PP-LCQ6-OM4-PT9	1019708	1
OS2 (PC) (E9 / 125 µm)	FOC-FDX20-PP-LCQ6-OSP-PT9	1019707	1
DIN rail splice box , for 6 x SC duplex			
Without pigtails	FOC-FDX20-PP-SCD6-MM	1019686	1
OM2 (G50 / 125 µm)	FOC-FDX20-PP-SCD6-OM2-PT9	1019700	1
OM4 (G50 / 125 µm)	FOC-FDX20-PP-SCD6-OM4-PT9	1019698	1
OS2 (PC) (E9 / 125 µm)	FOC-FDX20-PP-SCD6-OSP-PT9	1019692	1
DIN rail splice box , for 6 x ST duplex			
Without pigtails	FOC-FDX20-PP-STD6-MM	1019681	1
OM1 (G62,5 / 125 µm)	FOC-FDX20-PP-STD6-OM1-PT9	1019684	1
OM2 (G50 / 125 µm)	FOC-FDX20-PP-STD6-OM2-PT9	1019683	1
OS2 (PC) (E9 / 125 µm)	FOC-FDX20-PP-STD6-OSP-PT9	1019682	1
DIN rail splice box , for 6 x LSH duplex			
OS2 (APC) (E9 / 125 µm)	FOC-FDX20-PP-E2D6-OSA-PT9	1019680	1
Accessories			
Shrink splice protection , for FDX 20 splice boxes	FOC-SHRINKSPLICE-PROTECT	1019676	12
Crimp splice protection , for FDX 20 splice boxes	FOC-CRIMPSPLICE-PROTECT	1019678	12

FO 19" splice boxes



19" splice box

Technical data			
Material data			
Housing material	Sheet steel		
Flammability rating in accordance with UL 94	V0		
Color	light gray RAL 7035		
Degree of protection	IP20		
Insertion/withdrawal cycles	min. 1000		
Temperature data			
Ambient temperature (operation)	-10°C ... 60°C		
Ordering data			
Description	Type	Order No.	Pcs./Pkt.
19" splice box , 1 RU, fully pre-assembled ready to splice, for 12x LC duplex			
gray, OM2	FOC-SB-FR19:1U-LCD12-OM2 GY	1418815	1
black, OM4	FOC-SB-FR19:1U-LCD12-OM4 BK	1418817	1
19" splice box , 1 RU, fully pre-assembled ready to splice, for 24x LC duplex			
gray, OM2	FOC-SB-FR19:1U-LCD24-OM2 GY	1418816	1
black, OM4	FOC-SB-FR19:1U-LCD24-OM4 BK	1418818	1

Accessories for fiber optic assembly



Ferrule cleaner



Fiber stripper

Ordering data		Ordering data	
Description	Type	Order No.	Pcs./Pkt.
Ferrule cleaner , approx. 500 cleaning cycles			
1.25 mm, for LC	FOC-TOOL-FERRULECLEANER-1.25	1407032	1
2.50 mm, for ST, SC, FC	FOC-TOOL-FERRULECLEANER-2.50	1407029	1
Stick cleaner for couplings and plug end faces			
1.25 mm, for LC	FOC-TOOL-STICKCLEANER-1.25	1407000	1
2.50 mm, for ST, SC, FC	FOC-TOOL-STICKCLEANER-2.50	1407002	1

Tools for processing fiber optics



Fiber and T-stripper



Solvent dispenser and ceramic blade

Description	Ordering data			Type	Ordering data		
	Type	Order No.	Pcs./Pkt.		Order No.	Pcs./Pkt.	
Fiber stripper , for stripping the coating from 250 µm to 125 µm							
For 1 fiber	FOC-TOOL-STRIPPING-1HOLE-250	1407004	1				
For 2 fibers	FOC-TOOL-STRIPPING-2HOLE-250	1407008	1				
T-stripper							
AWG 18 ... 10/1.0 mm ... 2.6 mm	FOC-TOOL-STRIPPING-T-1	1407016	1				
AWG 30 ... 22 / 0.25 mm ... 0.64 mm	FOC-TOOL-STRIPPING-T-2	1407014	1				
Solvent dispenser , 100 ml, lockable pump dispenser				FOC-TOOL-DISPENSER	1406995	1	
Ceramic blade				FOC-TOOL-CERAMIC-BLADE	1407019	1	

Polishing accessories fiber optic connectors



Polishing film



Polishing disc

Description	Ordering data			Type	Ordering data		
	Type	Order No.	Pcs./Pkt.		Order No.	Pcs./Pkt.	
Polishing film , silicon carbide							
15 µm	FOC-POLISHINGFILM-SK-15.0	1407034	25				
Polishing film , ALO ²							
1 µm	FOC-POLISHINGFILM-AO-01.0	1407037	25				
3 µm	FOC-POLISHINGFILM-AO-03.0	1407039	25				
Polishing film , diamond							
0.1 µm	FOC-POLISHINGFILM-D-00.1	1407046	10				
1 µm	FOC-POLISHINGFILM-D-01.0	1407042	10				
9 µm	FOC-POLISHINGFILM-D-09.0	1407044	10				
Polishing disc							
1.25 mm, for LC				FOC-POLISHINGDISC-1.25	1407024	1	
2.50 mm, for ST, SC, FC				FOC-POLISHINGDISC-2.50	1407021	1	

Data connectors and cables

Network components – Accessories

Tools for FO cabling, POF

- For quick and easy field assembly
- No bonding or polishing
- Blade can be replaced easily on site
- Optimum attenuation values with easy assembly
- Reusable connectors



ERC

Description	Ordering data			Ordering data		
	Type	Order No.	Pcs./Pkt.	Type	Order No.	Pcs./Pkt.
Polymer fiber DIY Case , consisting of: Stripping knife, stripping pliers, polishing wheel for F-SMA and SC-RJ quick mounting connectors, polishing pad and emery paper						
Power meter measuring case , comprising an optical power meter, F-SMA and B-FOC (ST®) coupling, reference fibers, and operating instructions	PSM-POF-KONFTOOL	2744131	1			
Powermeter supplementary set for devices with SC-RJ interface, comprising one-meter polymer reference fiber (SC Simplex connector to F-SMA connector), one-meter PCF GI reference fiber (SC Simplex connector to B-FOC (ST®) connector), and SC-RJ coupling				PSM-FO-POWERMETER	2799539	1
Tool set for POF assembly , for field installation of SC connectors.				PSM-FO-POWERMETER SCRJ-SET	2901560	1
Cutting tool , SC-RJ, for polymer fiber				TF-SCRJ-POF KONF SET	1405246	1
Sheath stripping tool , for polymer fiber				CUTFOX-SCRJ-POF	1405247	1
Electrician's scissors , high cutting performance, thanks to micro-serrated cutting area, suitable for copper, aluminum (flexible), Kevlar® fibers, and plastic, two-component non-slip soft-grip handles, ergonomic design, adjustable screw joint				WIREFOX-PN POF	1405249	1
				CUTFOX-ES	1212621	1

Tools for FO cabling, PCF

- Cleave technology
- For quick and easy field assembly
- No bonding or polishing
- A real alternative to splicing
- Optimum attenuation values with easy assembly



Description	Ordering data		
	Type	Order No.	Pcs./Pkt.
Tool set for PCF assembly , for field installation of SC connectors			
PCF assembly case , stripping knife, stripping pliers, Aramid yarn scissors, fiber stripper, fiber cleaving tool and microscope - For SCRJ/SC duplex connectors - For B-FOC (ST®) connectors - For F-SMA connectors	FOC-TOOL-PCF KONF SET	1411051	1
Fiber cleaving tool for PCF fiber - For SCRJ/SC duplex connectors - For B-FOC (ST®) connectors - For F-SMA connectors	PSM-HCS-KONFTOOL/SC-RJ PSM-HCS-KONFTOOL/B-FOC PSM-HCS-KONFTOOL	2708876 2708465 2799526	1 1 1
	PSM-HCS-CLEAVETOOL/SCRJ PSM-HCS-CLEAVETOOL/B-FOC PSM-HCS-CLEAVETOOL	2313122 2708478 2744995	1 1 1

Tools for FO cabling, GOF

- Cleave technology
- For quick and easy field assembly
- No bonding or polishing
- A real alternative to splicing
- Optimum attenuation values with easy assembly
- Reusable connectors



Description	Ordering data		
	Type	Order No.	Pcs./Pkt.
Tool set for GOF assembly , for field installation of LC and SC connectors			
	FOC-TOOL-GOF KONF SET	1411049	1

RJ45 Ethernet cables

Notes:

For accessories, see page: 388

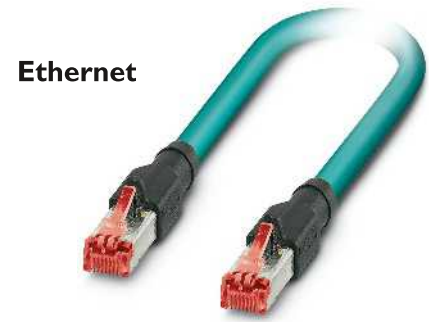

Ethernet

**RJ45 Ethernet cable
for IP20 applications**

		Technical data		
Cable, properties				
Transmission characteristics (category)		CAT5		
Conductor structure		7x 0.16 mm		
Conductor cross section		4x 2x 0.14 mm ²		
Conductor structure for signal		7x 0.16 mm		
AWG signal line		26		
Cable diameter		6.2 mm		
Conductor resistance		≤ 290 Ω/km (at 20°C)		
Type of shield		Tinned copper braided shield		
Conductor material		Bare Cu litz wires		
Outer sheath material		PUR		
Color of outer sheath		water blue RAL 5021		
Color, single wire		white/blue-blue, white/orange-orange, white/green-green, white/brown-brown		
General data				
Ambient temperature (operation)		-20°C ... 70°C (RJ45 connector)		
		Ordering data		
Description	Length of cable	Type	Order No.	Pcs./Pkt.
Ethernet cable, CAT5, pre-assembled				
	0.3 m	NBC-R4AC/0,3-94Z/R4AC	1423032	1
	0.5 m	NBC-R4AC/0,5-94Z/R4AC	1403926	1
	1 m	NBC-R4AC/1,0-94Z/R4AC	1403927	1
	1.75 m	NBC-R4AC/1,75-94Z/R4AC	1423433	1
	2 m	NBC-R4AC/2,0-94Z/R4AC	1403929	1
	3 m	NBC-R4AC/3,0-94Z/R4AC	1403930	1
	5 m	NBC-R4AC/5,0-94Z/R4AC	1403933	1
	10 m	NBC-R4AC/10,0-94Z/R4AC	1403934	1
	15 m	NBC-R4AC/15,0-94Z/R4AC	1410797	1
	20 m	NBC-R4AC/20,0-94Z/R4AC	1423033	1

RJ45 patch cables

Notes:

For accessories, see page: 388

Ethernet

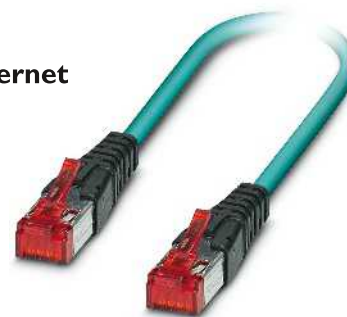
RJ45 patch cable
for IP20 applications

ERIC

Technical data

Cable, properties	
Transmission characteristics (category)	CAT6 _A
Conductor structure	6.00 mm +0.2 mm -0.1 mm
Conductor structure for signal	6.00 mm +0.2 mm -0.1 mm
AWG signal line	26
Type of shield	S/FTP
Outer sheath material	PUR
General data	
Ambient temperature (operation)	-25°C ... 70°C (RJ45 connector)

Ordering data

Description	Length of cable	Type	Order No.	Pcs./Pkt.
Patch cable, CAT6_A, pre-assembled, outer sheath color: water blue	0.3 m	NBC-R4AC1/0,3-94G/R4AC1-BU	1413158	1
	0.5 m	NBC-R4AC1/0,5-94G/R4AC1-BU	1413159	1
	1 m	NBC-R4AC1/1,0-94G/R4AC1-BU	1413160	1
	2 m	NBC-R4AC1/2,0-94G/R4AC1-BU	1413161	1
	3 m	NBC-R4AC1/3,0-94G/R4AC1-BU	1413162	1
	5 m	NBC-R4AC1/5,0-94G/R4AC1-BU	1413163	1
	10 m	NBC-R4AC1/10,0-94G/R4AC1-BU	1413164	1
	15 m	NBC-R4AC1/15,0-94G/R4AC1-BU	1413165	1
	20 m	NBC-R4AC1/20,0-94G/R4AC1-BU	1413166	1
	Patch cable, CAT6_A, pre-assembled, outer sheath color: yellow	0.3 m	NBC-R4AC1/0,3-94G/R4AC1-YE	1421168
0.5 m		NBC-R4AC1/0,5-94G/R4AC1-YE	1421169	1
1 m		NBC-R4AC1/1,0-94G/R4AC1-YE	1421170	1
2 m		NBC-R4AC1/2,0-94G/R4AC1-YE	1421171	1
3 m		NBC-R4AC1/3,0-94G/R4AC1-YE	1421172	1
5 m		NBC-R4AC1/5,0-94G/R4AC1-YE	1421173	1
10 m		NBC-R4AC1/10,0-94G/R4AC1-YE	1421174	1
15 m		NBC-R4AC1/15,0-94G/R4AC1-YE	1421175	1
20 m		NBC-R4AC1/20,0-94G/R4AC1-YE	1421176	1
Patch cable, CAT6_A, pre-assembled, outer sheath color: red		0.3 m	NBC-R4AC1/0,3-94G/R4AC1-RD	1421138
	0.5 m	NBC-R4AC1/0,5-94G/R4AC1-RD	1421139	1
	1 m	NBC-R4AC1/1,0-94G/R4AC1-RD	1421140	1
	2 m	NBC-R4AC1/2,0-94G/R4AC1-RD	1421141	1
	3 m	NBC-R4AC1/3,0-94G/R4AC1-RD	1421143	1
	5 m	NBC-R4AC1/5,0-94G/R4AC1-RD	1421144	1
	10 m	NBC-R4AC1/10,0-94G/R4AC1-RD	1421145	1
	15 m	NBC-R4AC1/15,0-94G/R4AC1-RD	1421146	1
	20 m	NBC-R4AC1/20,0-94G/R4AC1-RD	1421147	1

Accessories

The reliability of networks is becoming more and more important and is a decisive factor for the future of entire companies. Independent studies show that more than 70% of network errors and crashes are due to faulty cabling infrastructure and manipulation of the connecting cables.

With the new accessories for Factoryline patch cables, the various safety requirements for automation are comprehensively met.



Dust protection for SFN switches and FL MC 1000 and 2000 media converters



Security lock for SFN switches and FL MC 1000 and 2000 media converters

Description	Ordering data			Ordering data		
	Type	Order No.	Pcs./Pkt.	Type	Order No.	Pcs./Pkt.
Dust protection with color marking , for SFN switch and angled patch connector - Black - Blue - Brown - Yellow - Gray - Green - Red - Violet - White	FL DUST CVR BK FL DUST CVR BU FL DUST CVR BN FL DUST CVR YE FL DUST CVR GY FL DUST CVR GN FL DUST CVR RD FL DUST CVR VT FL DUST CVR WH	2891107 2891204 2891301 2891408 2891505 2891602 2891709 2891806 2891903	10 10 10 10 10 10 10 10 10			
Security frame for SFN switch and patch fields - Green - Red - White				FL PLUG GUARD GN FL PLUG GUARD RD FL PLUG GUARD WH	2891615 2891712 2891819	20 20 20
Locking element for security frame FL PLUG GUARD... - Locking element - Key				FL PORT GUARD FL PLUG GUARD KEY	2891220 2891327	20 1
Color marking for FL CAT... Patch... - Black - Blue - Brown - Yellow - Gray - Green - Red - Violet						
Security element for FL CAT ...patch... - Security element - Security element, lockable - Key						
Dust protection cap for RJ45 socket - Black - Gray						





Color coding
for RJ45 FL patch cables



Security element
for RJ45 FL patch cables



Dust protection
for RJ45 sockets

Ordering data			Ordering data			Ordering data		
Type	Order No.	Pcs./Pkt.	Type	Order No.	Pcs./Pkt.	Type	Order No.	Pcs./Pkt.
FL PATCH CCODE BK	2891194	20						
FL PATCH CCODE BU	2891291	20						
FL PATCH CCODE BN	2891495	20						
FL PATCH CCODE YE	2891592	20						
FL PATCH CCODE GY	2891699	20						
FL PATCH CCODE GN	2891796	20						
FL PATCH CCODE RD	2891893	20						
FL PATCH CCODE VT	2891990	20						
			FL PATCH SAFE CLIP	2891246	20			
			FL PATCH GUARD	2891424	20			
			FL PATCH GUARD KEY	2891521	1			
						FL RJ45 PROTECT CAP	2832991	10
						FL RJ45 PROTECT CAP GY	1065531	100



19" patch bays

new

new



19" patch bay



19" mounting frame

	Technical data			Technical data		
Material data	FOC-FR19:1U-2OS12-LCD12-OM1			FOC-FR19:3U		
Housing material	Aluminum alloy			Aluminum alloy		
Flammability rating in accordance with UL 94	V0			V0		
Temperature data						
Ambient temperature (operation)	-10°C ... 60°C (IEC 61300-2-22)			-20°C ... 60°C (IEC 61300-2-22)		
	Ordering data			Ordering data		
Description	Type	Order No.	Pcs./Pkt.	Type	Order No.	Pcs./Pkt.
19" patch bay, 1 RU, 2 x Q-ODC-12 female to 12 x LC duplex coupling	FOC-FR19:1U-2OS12-LCD12-OM1	1419973	1			
19" mounting frame, 3 RU, modular, unassembled				FOC-FR19:3U	1419976	1
Module insert, marshalling panel, for 19" mounting frame, 3 RU, 1 x Q-ODC-12 female to 6 x LC duplex coupling				FOC-MODUL:3U-OS12-LCD6-OM1	1419978	1
	Accessories			Accessories		
Patch cable, IP68, 10 meters, Q-ODC-12 male to Q-ODC-12 male	FOC-OP12-OP12-GL02/10	1415353	1	FOC-OP12-OP12-GL02/10	1415353	1

19" patch bays



Ethernet



Patch bay for 19" rack and matching female inserts



Ethernet



Patch bay for 19" rack and matching female inserts

	Technical data			Technical data		
Material data	VS-PP-19-1HE-16-F			CUC-PP-FR19:1U-I-EMPTY:24		
Housing material	PC-GF			PC-GF		
Flammability rating in accordance with UL 94	V0			V0		
Temperature data	5°C ... 55°C			5°C ... 55°C		
Ambient temperature (operation)	5°C ... 55°C			5°C ... 55°C		
	Ordering data			Ordering data		
Description	Type	Order No.	Pcs./Pkt.	Type	Order No.	Pcs./Pkt.
Patch panel , 19" mounting, IP20, with 16 installation slots for contact inserts with Freenet system	VS-PP-19-1HE-16-F	1652994	1			
Patch bay , 19" mounting, IP20, with 24 installation slots for RJ45 cable connection module, adapter-free						
gray				CUC-PP-FR19:1U-I-EMPTY:24	1422978	1
black				CUC-PP-FR19:1U-I-EMPTY:24 BK	1422979	1
	Accessories			Accessories		
RJ45 Freenet socket insert , 8-pos., shielded, with cable connection						
1 Gbps, CAT5	VS-08-BU-RJ45-5-F/PK	1652936	1			
SC-RJ coupling , for terminal outlets VS-TO-... and 19" patch panels VS-PP-19-1HE-16-F and front plate VS-SI-FP-2F						
1x SC-RJ (duplex)	VS-SCRJ-GOF-KU	1654358	1			
LC/LC coupling for mounting in angled patch connectors and patch panels with Freenet slots						
1 x LC/LC (duplex, multimode fiber)	FL MM PATCH COUPLER LC-LC	2700312	1			
1x LC/LC (duplex, single-mode fiber (PC))	FL SM PATCH COUPLER LC-LC	2700313	1			
Insert , for patch bay						
MTP coupling, type A				FOC-I-D1PGY-S/MPAGC	1041820	1
MTP coupling, type B				FOC-I-D1PGY-S/MPBGC	1041840	1
LC duplex coupling				FOC-I-D1PGN-S/LCGCSM	1041780	1
SC simplex coupling				FOC-I-D1PGR-S/SCGCSM	1041800	1
RJ45 female insert, CAT6 _A				CUC-I-J1ZNI-S/R4IDC8	1417274	1
USB socket insert , 4-pos., female USB to flat-ribbon cable terminal strip, 2.54 pitch, socket, type A	VS-04-BUA-FK-F/IP67	1653854	1			
USB socket insert , 4-pos., female USB to flat-ribbon cable terminal strip, 2.54 pitch, socket, type B	VS-04-BUB-FK-F/IP67	1653867	1			

Data connectors and cables

Network components – Assembled cables

Network cables, sold by the meter, PROFINET, EtherCAT®, shielded

Notes:
For information about the cable qualities, see page 454



4-wire, star quad, cable coil



4-wire, star quad, cable drum

ERC

Description	Ordering data			Ordering data		
	Type	Order No.	Pcs./Pkt.	Type	Order No.	Pcs./Pkt.
PVC rigid - green , 1 x 4 x 22 AWG, CAT5, SF/TQ, type A						
Cable coil: 100 m	VS-OE-OE-93A-100,0	1416392	1			
Cable coil: 1 m ... 100 m	VS-93A/...	1416486	1			
PVC flexible - green , 1 x 4 x 22 AWG, CAT5, SF/TQ, type B						
Cable coil: 100 m	VS-OE-OE-93B-100,0	1416389	1			
Cable coil: 1 m ... 100 m	VS-OE-OE-93B/...	1417362	1	NBC-93B/...	1408537	1
Cable drum: 110 m ... 500 m						
PUR suitable for use with drag chain - green, 1 x 4 x 22 AWG, CAT5, SF/TQ, type C						
Cable coil: 100 m	VS-OE-OE-93C-100,0	1416376	1			
Cable coil: 1 m ... 100 m	VS-OE-OE-93C/...	1417491	1	NBC-93C/...	1408538	1
Cable drum: 110 m ... 500 m						
PUR suitable for use with robots - green, 1 x 4 x 22 AWG, CAT5, S/TQ						
Cable coil: 100 m	VS-OE-OE-93R-100,0	1416363	1			
Cable coil: 1 m ... 100 m	VS-OE-OE-93R/...	1417388	1	NBC-93R/...	1408539	1
Cable drum: 110 m ... 500 m						
RADOX® for railway applications - black, 1 x 4 x 22 AWG, CAT5, SF/TQ						
Cable coil: 1 m ... 100 m	VS-OE-OE-937/...	1402687	1	NBC-937/...	1408540	1
Cable drum: 110 m ... 500 m						

Ordering example for cables with variable cable length:

For a 34.0 m long type 93A network cable, the ordering data is as follows:

Order No.	Length [m]
1416486	34.0
	100 m, maximum
	Increment:
	1.0 m ... 100 m = 1.0 m
	110 m ... 500 m = 10 m

**Network cables, sold by the meter,
Ethernet, shielded**

Notes:
For information about the cable qualities, see page 454

Ethernet



**2-pair,
twisted pair**

Ethernet



**4-pair,
twisted pair**

ERC

ERC

Description	Ordering data			Ordering data		
	Type	Order No.	Pcs./Pkt.	Type	Order No.	Pcs./Pkt.
PUR flexible - blue, 2 x 2 x 26 AWG, CAT5, SF/UTP						
Cable coil: 100 m	VS-OE-OE-93E-100,0	1416295	1			
Cable coil: 1 m ... 100 m	VS-OE-OE-93E/...	1417320	1			
Cable drum: 110 m ... 500 m	NBC-93E/...	1408534	1			
PUR rigid - blue, 4 x 2 x 24 AWG, CAT5, SF/UTP						
Cable coil: 100 m				VS-OE-OE-94A-100,0	1416305	1
Cable coil: 1 m ... 100 m				VS-94A/...	1416415	1
PUR flexible - blue, 4 x 2 x 26 AWG, CAT5, SF/UTP						
Cable coil: 100 m				VS-OE-OE-94B-100,0	1416567	1
Cable coil: 1 m ... 100 m				VS-OE-OE-94B/...	1417333	1
Cable drum: 110 m ... 500 m				NBC-94B/...	1408535	1
PUR suitable for use with drag chain - blue, 4 x 2 x 26 AWG, CAT5, S/UTP						
Cable coil: 100 m				VS-OE-OE-94C-100,0	1416318	1
Cable coil: 1 m ... 100 m				VS-OE-OE-94C/...	1417346	1
Cable drum: 110 m ... 500 m				NBC-94C/...	1408536	1
PVC flexible, outdoor - black, 4 x 2 x 26 AWG, CAT5, SF/UTP						
Cable coil: 100 m				VS-OE-OE-94D-100,0	1416334	1
Cable coil: 1 m ... 100 m				VS-94D/...	1416444	1
FRNC rigid - blue, 4 x 2 x 23 AWG, CAT7, S/FTP						
Cable coil: 100 m				VS-OE-OE-94E-100,0	1416350	1
Cable coil: 1 m ... 100 m				VS-94E/...	1416460	1
PUR flexible - blue, 4 x 2 x 26 AWG, CAT6 _A , S/FTP						
Cable coil: 100 m				VS-OE-OE-94F-100,0	1416347	1
Cable coil: 1 m ... 100 m				VS-OE-OE-94F/...	1417359	1

**Ordering example for cables with
variable cable length:**

For a 34.0 m long **type 94A** network cable,
the ordering data is as follows:

Order No.	Length [m]
1416415	34.0 100 m, maximum
	Increment: 1.0 m ... 100 m = 1.0 m 110 m ... 500 m = 10 m

Assembled cables,
PROFINET, EtherCAT®, Ethernet,
4-pos., shielded, A-coded



PROFINET Ethernet

EtherCAT

M8 male connector

M8 female connector



M8MS

M8FS

Ordering data

Ordering data

Order No.

Order No.

Open cable end



OE

1 m 1407344
2 m 1407345
5 m 1407346
10 m 1407347

Variable 1408719

Variable 1408716

M8 male connector



M8MS

1 m 1407348
2 m 1407349
5 m 1407350
10 m 1407351

Variable 1408718

Variable 1408715

RJ45 connector, IP20



R4AC

1 m 1407352
2 m 1407353
5 m 1407354
10 m 1407355

Variable 1408717

Variable 1408714

Information for products with fixed cable length:

Products with fixed cable length are produced with the 93B cable type and are available from stock.

Ordering data for cables with variable cable length:

For a 4.5 m long type 93B network cable with M8 male connector, straight and RJ45 connector, IP20, the ordering data is as follows:

Order No.	Cable type	Length [m] Max. 40 m
1408717	93B	4.5
Minimum order qty: 25 pcs.		
Increments: 0.2 ... 3 m = 0.1 m > 3 m = 0.5 m		

Pin	Wire color		Signal
	M8	RJ45	
2	1	YE	TD+
3	2	OG	TD-
1	3	WH	RD+
4	6	BU	RD-

Technical data

PROFINET PVC flexible CAT5 [93B]

Transmission characteristics (category)
Cable structure
Conductor cross section
Conductor structure for signal
AWG signal line
Cable diameter
Conductor resistance
Type of shield

Conductor material
Outer sheath material
Color of outer sheath
Color, single wire

Ambient temperature
Fixed installation [°C]
Flexible installation [°C]

CAT5
1x4xAWG22/7; SF/TQ
4x 0.34 mm²
7x 0.25 mm
22
6.5 mm
-
Aluminum-coated foil, tinned copper braided shield
Tin-plated Cu litz wires
PVC
green RAL 6018
White, yellow, blue, orange

-40 ... 70
-40 ... 70

Assembled cables,
PROFINET, EtherCAT®, Ethernet,
4-pos., shielded, D-coded



Open cable end



OE

M8 male connector



M8MSD

M8 male connector



M8MRD

RJ45 connector, IP20



R4AC

M8 male connector



M8MSD

M8 male connector



M8MRD

Ordering data

Order No.

1 m	1423703
2 m	1423704
5 m	1423705
10 m	1423706

Ordering data

Order No.

1 m	1080526
2 m	1080528
5 m	1080530
10 m	1080531

1 m	1423707
2 m	1423708
5 m	1423709
10 m	1423710

1 m	1080538
2 m	1080539
5 m	1080540
10 m	1080542

1 m	1080532
2 m	1080535
5 m	1080536
10 m	1080537

1 m	1423711
2 m	1423712
5 m	1423713
10 m	1423714

1 m	1080543
2 m	1080544
5 m	1080545
10 m	1080546

Information for products with fixed cable length:

Products with fixed cable length are produced with the 93C cable type and are available from stock.

Pin	RJ45	Wire color	Signal
1	1	YE	TD+
3	2	OG	TD-
2	3	WH	RD+
4	6	BU	RD-

Technical data

PROFINET drag chain CAT5 [93C]

CAT5
1x4xAWG22/7; SF/TQ
4x 0.34 mm ²
7x 0.25 mm
22
6.5 mm
-
Aluminum-coated foil, tinned copper braided shield
Tin-plated Cu litz wires
PUR
green RAL 6018
White, yellow, blue, orange

Transmission characteristics (category)

Cable structure
Conductor cross section
Conductor structure for signal
AWG signal line
Cable diameter
Conductor resistance
Type of shield

Conductor material
Outer sheath material
Color of outer sheath
Color, single wire

Ambient temperature

Fixed installation	[°C]	-40 ... 70
Flexible installation	[°C]	-40 ... 70

Data connectors and cables

Network components – Assembled cables

Assembled cables,
PROFINET, EtherCAT®,
4-pos., shielded, CAT5



Open cable end



OE

RJ45 connector, IP20



R4AC

RJ45 connector, IP20



R4ACR

RJ45 connector, Version 14, metal



R4RC

RJ45 connector, Version 14, plastic



R4QC

M12 male connector



MSD SCO

M12 male connector



MRD SCO

	RJ45 connector, IP20	RJ45 connector, IP20	RJ45 connector, Version 14, metal
	R4AC	R4ACR	R4RC
Ordering data	Ordering data	Ordering data	Ordering data
Order No.	Order No.	Order No.	Order No.
Open cable end			5.00 m 1416162
RJ45 connector, IP20	Variable 1411857	Variable 1411858	Variable 1411859
	1.00 m 1408968	1.00 m 1418248	
	2.00 m 1408969	2.00 m 1418277	
	5.00 m 1408970		5.00 m 1416138
	10.00 m 1408971		
	Variable 1411861	Variable 1411862	Variable 1411863
RJ45 connector, IP20		1.00 m 1409002	
		2.00 m 1409003	
		5.00 m 1409004	
		10.00 m 1409005	
		Variable 1411865	
RJ45 connector, Version 14, metal			1.00 m 1408974
			2.00 m 1408975
			5.00 m 1408972
			10.00 m 1408976
			Variable 1411866
RJ45 connector, Version 14, plastic			
M12 male connector			
M12 male connector			

Information for products with fixed cable length:

Products with fixed cable length are produced with the 93B cable type and are available from stock.

Ordering data for cables with variable cable length:

For a 4.5 m long type 93C network cable with M12 male connector, straight and RJ45 connector, IP20, the ordering data is as follows:

Cable description	Cable type	Pin		Wire color	Signal
		M12	RJ45		
PVC flexible – green, 1 x 4, CAT5	93B	1	1	YE	TD+
		3	2	OG	TD-
PUR suitable for drag chain applications – green, 1 x 4, CAT5	93C	2	3	WH	RD+
		4	6	BU	RD-
PUR for robot applications – green, 1 x 4, CAT5	93R				
RADOX® for railway applications – black, 1 x 4, CAT5	937				
PUR flexible – green, 1 x 4, CAT5	93M				

Order No.	Cable type	Length [m] Max. 40 m
1408639	93C	4.5
Minimum order qty: 25 pcs.		Increments: 0.2 ... 3 m = 0.1 m > 3 m = 0.5 m

Note:
The maximum length is 100 m for 2 x RJ45 connectors and 1 x RJ45 connector with open cable end.

RJ45 connector, Version 14, plastic	M12 male connector	M12 male connector	M12 female connector	M12 female connector	M12 flush-type female connector, rear mounting
					
R4QC	MSD SCO	MRD SCO	FSD SCO	FRD SCO	FSDBP
Ordering data	Ordering data	Ordering data	Ordering data	Ordering data	Ordering data
Order No.	Order No.	Order No.	Order No.	Order No.	Order No.
5.00 m 1416168	1 m 1407495 2 m 1407496 5 m 1407497 10 m 1407498 Variable 1408640	Variable 1408633	1 m 1407528 2 m 1407529 5 m 1407530 10 m 1407531 Variable 1408623	Variable 1408615	1 m 1437779 2 m 1437782 5 m 1437795
5.00 m 1416141	1 m 1407499 2 m 1407500 5 m 1407501 10 m 1407502 Variable 1408639	Variable 1408632	1 m 1407532 2 m 1407533 5 m 1407534 10 m 1407535 Variable 1408622	Variable 1408613	
	1 m 1407508 2 m 1407509 5 m 1407510 10 m 1407511 Variable 1408638	Variable 1408631	1 m 1407536 2 m 1407537 5 m 1407538 10 m 1407539 Variable 1408621	Variable 1408612	
	1 m 1407516 2 m 1407517 5 m 1407518 10 m 1407519 Variable 1408636	Variable 1408628	1 m 1407544 2 m 1407545 5 m 1407546 10 m 1407547 Variable 1408619	Variable 1408610	
1.00 m 1408978 2.00 m 1408979 5.00 m 1408977 10.00 m 1408980 Variable 1411867	1 m 1407520 2 m 1407521 5 m 1407522 10 m 1407523 Variable 1408635	Variable 1408626	1 m 1407548 2 m 1407549 5 m 1407551 10 m 1407552 Variable 1408618	Variable 1408609	
	1 m 1407524 2 m 1407525 5 m 1407526 10 m 1407527 Variable 1408634	Variable 1408625	1 m 1407553 2 m 1407554 5 m 1407555 10 m 1407556 Variable 1408617	Variable 1408608	
		Variable 1408624	Variable 1408616	Variable 1408607	

	Technical data	Technical data	Technical data	Technical data
Transmission characteristics (category)	PROFINET PVC flexible CAT5 [93B]	PROFINET drag chain CAT5 [93C]	PROFINET robot CAT5 [93R]	PROFINET railway applications [937]
Cable structure	CAT5 1x4xAWG22/7; SF/TQ	CAT5 1x4xAWG22/7; SF/TQ	CAT5 1x4xAWG22/19; S/TQ	CAT5 1x4xAWG22/7; SF/TQ
Conductor cross section	4x 0.34 mm ²	4x 0.34 mm ²	4x 0.34 mm ²	4x 0.34 mm ²
Conductor structure for signal	7x 0.25 mm	7x 0.25 mm	19x 0.15 mm	7x 0.25 mm
AWG signal line	22	22	22	22
Cable diameter	6.5 mm	6.5 mm	6.5 mm	6.6 mm
Conductor resistance	-	-	-	≤ 54.4 Ω/km
Type of shield	Aluminum-coated foil, tinned copper braided shield	Aluminum-coated foil, tinned copper braided shield	Tinned copper braided shield	Plastic-coated aluminum foil, tinned copper braided shield
Conductor material	Tin-plated Cu litz wires	Tin-plated Cu litz wires	Tin-plated Cu litz wires	silver-plated Cu litz wires
Outer sheath material	PVC	PUR	PUR	PE-X
Color of outer sheath	green RAL 6018	green RAL 6018	green RAL 6018	black RAL 9005
Color, single wire	White, yellow, blue, orange	White, yellow, blue, orange	White, yellow, blue, orange	white-blue, orange-yellow
Ambient temperature				
Fixed installation	[°C] -40 ... 70	[°C] -40 ... 70	[°C] -40 ... 80	[°C] -50 ... 90
Flexible installation	[°C] -40 ... 70	[°C] -40 ... 70	[°C] -40 ... 80	[°C] -40 ... 90

Network components – Assembled cables

**Assembled cables,
Ethernet, 4-pos.,
shielded, CAT5**



Ethernet

Open cable end



OE

RJ45 connector, IP20



R4AC

RJ45 connector, Version 6



R4MC

RJ45 connector, Version 14, metal



R4RC

RJ45 connector, Version 14, plastic



R4QC

M12 male connector



MSD SCO

M12 male connector



MRD SCO

	RJ45 connector, IP20	RJ45 connector, Version 6	RJ45 connector, Version 14, metal
	R4AC	R4MC	R4RC
Ordering data	Ordering data	Ordering data	Ordering data
Order No.	Order No.	Order No.	Order No.
1.00 m	1405633	2.00 m	1405675
2.00 m	1405675	5.00 m	1405743
5.00 m	1405743	Variable	1411829
Variable	1411827	Variable	1411828
1.00 m	1408933	2.00 m	1405921
2.00 m	1408934	5.00 m	1405992
5.00 m	1408935	Variable	1411833
10.00 m	1408936	Variable	1411832
Variable	1411831	1.00 m	1408937
		2.00 m	1408938
		5.00 m	1408939
		10.00 m	1408940
		Variable	1411835
		1.00 m	1408941
		2.00 m	1408942
		5.00 m	1408943
		10.00 m	1408945
		Variable	1411836

Information for products with fixed cable length:

Products with fixed cable length are produced with the 93E cable type and are available from stock.

Ordering data for cables with variable cable length:

For a 4.5 m long type 93E network cable with M12 male connector, straight and RJ45 connector, IP20, the ordering data is as follows:

Order No.	Cable type	Length [m] Max. 40 m
1408712	93E	4.5
Minimum order qty: 25 pcs.		Increments: 0.2 ... 3 m = 0.1 m > 3 m = 0.5 m

Note:
The maximum length is 100 m for 2 x RJ45 connectors and 1 x RJ45 connector with open cable end.

Cable description	Cable type	Pin		Wire color	Signal
		M12	RJ45		
PUR flexible – blue, 2 x 2, CAT5	93E	1	1	WHOG	TD+
		3	2	OG	TD-
		2	3	WHGN	RD+
		4	6	GN	RD-

RJ45 connector, Version 14, plastic	M12 male connector	M12 male connector	M12 female connector	M12 female connector	M12 flush-type female connector, rear mounting
R4QC	MSD SCO	MRD SCO	FSD SCO	FRD SCO	FSDBP
Ordering data	Ordering data	Ordering data	Ordering data	Ordering data	Ordering data
Order No.	Order No.	Order No.	Order No.	Order No.	Order No.
5.00 m 1405772	1 m 1407356 2 m 1407357 5 m 1407358 10 m 1407359 Variable 1408713	Variable 1408705	1 m 1407380 2 m 1407381 5 m 1407382 10 m 1407383 Variable 1408697	Variable 1408690	2 m 1405866
5.00 m 1406030	1 m 1407360 2 m 1407361 5 m 1407362 10 m 1407363 Variable 1408712	Variable 1408704	1 m 1407384 2 m 1407385 5 m 1407386 10 m 1407387 Variable 1408696	Variable 1408689	2.00 m 1406085
	1 m 1407364 2 m 1407365 5 m 1407366 10 m 1407367 Variable 1408710	Variable 1408703	1 m 1407388 2 m 1407389 5 m 1407390 10 m 1407391 Variable 1408695	Variable 1408688	2.00 m 1406247
	1 m 1407368 2 m 1407369 5 m 1407370 10 m 1407371 Variable 1408709	Variable 1408702	1 m 1407392 2 m 1407393 5 m 1407394 10 m 1407395 Variable 1408694	Variable 1408687	2.00 m 1406519
1.00 m 1408947 2.00 m 1408948 5.00 m 1408946 10.00 m 1408949 Variable 1411837	1 m 1407372 2 m 1407373 5 m 1407374 10 m 1407375 Variable 1408707	Variable 1408701	1 m 1407396 2 m 1407397 5 m 1407398 10 m 1407399 Variable 1408693	Variable 1408686	2.00 m 1406603
	1 m 1407376 2 m 1407377 5 m 1407378 10 m 1407379 Variable 1408706	Variable 1408700	1 m 1407400 2 m 1407401 5 m 1407402 10 m 1407403 Variable 1408692	Variable 1408684	
		Variable 1408699	Variable 1408691	Variable 1408683	

Technical data

PUR ETHERNET 2x2 FLEX [93E]

Transmission characteristics (category)
Cable structure
Conductor cross section
Conductor structure for signal
AWG signal line
Cable diameter
Conductor resistance
Type of shield

CAT5
2x2xAWG26/7; SF/UTP
2x 2x 0.14 mm²
7x 0.16 mm
26
6.4 mm
-
Aluminum-coated foil,
tinned copper braided shield

Conductor material
Outer sheath material
Color of outer sheath
Color, single wire

Bare Cu litz wires
PUR
water blue RAL 5021
white/orange-orange,
white/green-green

Ambient temperature

Fixed installation	[°C]	-40 ... 80
Flexible installation	[°C]	-20 ... 80

Network components – Assembled cables

Assembled cables, Ethernet, 8-pos., shielded, CAT5



Ethernet

Open cable end



OE

RJ45 connector, IP20



R4AC

RJ45 connector, Version 6



R4MC

RJ45 connector, Version 14, metal



R4RC

RJ45 connector, Version 14, plastic



R4QC

M12 male connector



MS SCO

M12 male connector



MR SCO

	RJ45 connector, IP20	RJ45 connector, Version 6	RJ45 connector, Version 14, metal
	R4AC	R4MC	R4RC
Ordering data	Ordering data	Ordering data	Ordering data
Order No.	Order No.	Order No.	Order No.
5.00 m	1407699	5.00 m 1407725	5.00 m 1407783
Variable	1411838	Variable 1411839	Variable 1411840
1.00 m	1408950		
2.00 m	1408951		
5.00 m	1408952	5.00 m 1407932	5.00 m 1407990
10.00 m	1408953		
Variable	1411842	Variable 1411843	Variable 1411844
		1.00 m 1408955	
		2.00 m 1408956	
		5.00 m 1408954	
		10.00 m 1408958	
		Variable 1411846	
			1.00 m 1408961
			2.00 m 1408962
			5.00 m 1408959
			10.00 m 1408963
			Variable 1411847

Information for products with fixed cable length:

Products with fixed cable length are produced with the **94B** cable type and are available from stock.

Ordering data for cables with variable cable length:

For a **4.5 m long type 94C** network cable with **M12 male connector, straight** and **RJ45 connector, IP20**, the ordering data is as follows:

Order No.	Cable type	Length [m] Max. 40 m
1408681	94C	4.5
Minimum order qty: 25 pcs.		Increments: 0.2 ... 3 m = 0.1 m > 3 m = 0.5 m

Note:
The maximum length is 100 m for 2 x RJ45 connectors and 1 x RJ45 connector with open cable end.

Cable description	Cable type	Pin		Wire color	Signal
		M12	RJ45		
PUR flexible – blue, 4 x 2, CAT5	94B	6	1	WHOG	D1+
		4	2	OG	D1–
		1	5	WHBU	D3–
		7	4	BU	D3+
		5	3	WHGN	D2+
		8	6	GN	D2–
		2	7	WHBN	D4+
		3	8	BN	D4–
PUR suitable for drag chain applications – blue, 4 x 2, CAT5	94C				

RJ45 connector, Version 14, plastic	M12 male connector	M12 male connector	M12 female connector	M12 female connector	M12 flush-type female connector, rear mounting
R4QC	MS SCO	MR SCO	FS SCO	FR SCO	FSBP
Ordering data	Ordering data	Ordering data	Ordering data	Ordering data	Ordering data
Order No.	Order No.	Order No.	Order No.	Order No.	Order No.
5.00 m 1407819	1 m 1407404 2 m 1407405 5 m 1407406 10 m 1407407	Variable 1408675	1 m 1407439 2 m 1407440 5 m 1407441 10 m 1407442	Variable 1408657	5 m 1407877
Variable 1411841	Variable 1408682		Variable 1408665		
5.00 m 1412024	1 m 1407414 2 m 1407415 5 m 1407416 10 m 1407417	Variable 1408674	1 m 1407443 2 m 1407444 5 m 1407445 10 m 1407446	Variable 1408655	5.00 m 1412082
Variable 1411845	Variable 1408681		Variable 1408664		
	2 m 1407423 5 m 1407424 10 m 1407425	Variable 1408671	1 m 1407451 2 m 1407452 5 m 1407453 10 m 1407454	Variable 1408653	
	Variable 1408679		Variable 1408662		
	1 m 1407426 2 m 1407427 5 m 1407428 10 m 1407429	Variable 1408670	1 m 1407455 2 m 1407456 5 m 1407457 10 m 1407458	Variable 1408652	5.00 m 1412503
	Variable 1408678		Variable 1408661		
1.00 m 1408965 2.00 m 1408966 5.00 m 1408964 10.00 m 1408967	1 m 1407430 2 m 1407431 5 m 1407432 10 m 1407433	Variable 1408668	1 m 1407459 2 m 1407460 5 m 1407461 10 m 1407462	Variable 1408651	5.00 m 1412590
Variable 1411848	Variable 1408677		Variable 1408660		
	1 m 1407434 2 m 1407435 5 m 1407436 10 m 1407438	Variable 1408667	1 m 1407463 2 m 1407464 5 m 1407465 10 m 1407466	Variable 1408650	
	Variable 1408676		Variable 1408659		
		Variable 1408666	Variable 1408658	Variable 1408649	

	Technical data	Technical data
	Ethernet, flexible, CAT5 [94B]	Ethernet drag chain CAT5 [94C]
Transmission characteristics (category)	CAT5	CAT5
Cable structure	4x2xAWG26/7; SF/UTP	4x2xAWG26/19; S/UTP
Conductor cross section	4x 2x 0.14 mm ²	4x 2x 0.14 mm ²
Conductor structure for signal	7x 0.16 mm	19x 0.10 mm
AWG signal line	26	26
Cable diameter	6.4 mm	6.9 mm
Conductor resistance	≤ 290 Ω/km	-
Type of shield	Aluminum-coated foil, tinned copper braided shield	Tinned copper braided shield
Conductor material	Bare Cu litz wires	Bare Cu litz wires
Outer sheath material	PUR	PUR
Color of outer sheath	water blue RAL 5021	water blue RAL 5021
Color, single wire	white/blue-blue, white/orange-orange, white/green-green, white/brown-brown	white/blue-blue, white/orange-orange, white/green-green, white/brown-brown
Ambient temperature		
Fixed installation	[°C] -40 ... 80	-40 ... 80
Flexible installation	[°C] -20 ... 80	-20 ... 80

Data connectors and cables

Network components – Assembled cables

Assembled cables,
Ethernet, CC-Link IE, 8-pos.,
shielded, CAT6_A



Ethernet 

CC-Link IE

	RJ45 connector, IP20	RJ45 connector, Version 6	RJ45 connector, Version 14, metal
			
	R4AC	R4MC	R4RC
Ordering data	Ordering data	Ordering data	Ordering data
Order No.	Order No.	Order No.	Order No.
Open cable end			
			
OE	Variable	Variable	Variable
RJ45 connector, IP20	1411853	1415639	1415637
	1.00 m 1418866		
R4AC	2.00 m 1408360		
RJ45 connector, Version 6	5.00 m 1418879		
	10.00 m 1408367		
R4MC	Variable 1411854	Variable 1414321	Variable 1411855
RJ45 connector, Version 14, metal		Variable 1414322	
			
R4RC			Variable 1414323
RJ45 connector, Version 14, plastic			
			
R4QC			
M12 male connector			
			
MSX SCO			
M12 male connector			
			
M12MRX			

Information for products with fixed cable length:

Products with fixed cable length are produced with the 94F cable type and are available from stock.

Ordering data for cables with variable cable length:

For a 4.5 m long type 94F network cable with M12 male connector, straight and RJ45 connector, IP20, the ordering data is as follows:

Order No.	Cable type	Length [m] Max. 40 m
1408647	94F	4.5
Minimum order qty: 25 pcs.		Increments: 0.2 ... 3 m = 0.1 m > 3 m = 0.5 m

Note:
The maximum length is 100 m for 2 x RJ45 connectors and 1 x RJ45 connector with open cable end.

Cable description	Cable type	Pin		Wire color	Signal
		M12	RJ45		
PUR flexible – blue, 4 x 2, CAT6 _A	94F	1	1	WHOG	D1+
		2	2	OG	D1–
		7	5	WHBU	D3–
		8	4	BU	D3+
		3	3	WHGN	D2+
		4	6	GN	D2–
5	7	WHBN	D4+		
6	8	BN	D4–		

RJ45 connector, Version 14, plastic	M12 male connector	M12 male connector	M12 female connector	M12 female connector	M12 flush-type female connector, rear mounting
					
R4QC	MSX SCO	M12MRX	M12FSX	M12FRX	FSBPX
Ordering data	Ordering data	Ordering data	Ordering data	Ordering data	Ordering data
Order No.	Order No.	Order No.	Order No.	Order No.	Order No.
	1 m 1407467 2 m 1407468 5 m 1407469 10 m 1407470 Variable 1415638	1 m 1080716 2 m 1080717 5 m 1080718 10 m 1080719	1 m 1080728 2 m 1080729 5 m 1080731 10 m 1080732	1 m 1080746 2 m 1080747 5 m 1080748 10 m 1080750	0.5 m 1424135 1 m 1424148 2 m 1424151 5 m 1424164
	1 m 1407471 2 m 1407472 5 m 1407473 10 m 1407474 Variable 1411856		1 m 1080733 2 m 1080734 5 m 1080736 10 m 1080737		
	1 m 1407475 2 m 1407476 5 m 1407477 10 m 1407478 Variable 1408646		1 m 1080738 2 m 1080739 5 m 1080740 10 m 1080741		
	1 m 1407479 2 m 1407480 5 m 1407481 10 m 1407482 Variable 1414324				
	1 m 1407483 2 m 1407484 5 m 1407485 10 m 1407486 Variable 1408644	1 m 1080724 2 m 1080725 5 m 1080726 10 m 1080727	1 m 1080742 2 m 1080743 5 m 1080744 10 m 1080745	1 m 1080751 2 m 1080752 5 m 1080753 10 m 1080754	
		1 m 1080720 2 m 1080721 5 m 1080722 10 m 1080723			

Technical data

Ethernet 10 Gbit [94F]

Transmission characteristics (category)	CAT6 _A
Cable structure	4x2xAWG26/7; S/FTP
Conductor cross section	4x 2x 0.14 mm ²
Conductor structure for signal	7x 0.16 mm
AWG signal line	26
Cable diameter	6.4 mm
Conductor resistance	-
Type of shield	Tinned copper braided shield
Type of pair shielding	Aluminum-lined foil
Conductor material	Bare Cu litz wires
Outer sheath material	PUR
Color of outer sheath	water blue RAL 5021
Color, single wire	white/blue-blue, white/orange-orange, white/green-green, white/brown-brown

Ambient temperature	
Fixed installation	[°C] -40 ... 80
Flexible installation	[°C] -20 ... 80

Assembled cables for railway applications, Ethernet, shielded, CAT6_A



Ethernet



Open cable end



OE

M12 male connector, straight



MSX SCO

M12 male connector



MSX SCO

Ordering data

Order No.

2 m	1415599
5 m	1415600
10 m	1415601

2 m	1415595
5 m	1415598

Pin M12	Wire color	Signal
1	WHOG	D1+
2	OG	D1-
7	WHBU	D3-
8	BU	D3+
3	WHGN	D2+
4	GN	D2-
5	WHBN	D4+
6	BN	D4-

Transmission characteristics (category)
 Cable structure
 Conductor cross section
 Conductor structure for signal
 AWG signal line
 Cable diameter
 Conductor resistance
 Type of shield

Type of pair shielding

Conductor material
 Outer sheath material
 Color of outer sheath
 Color, single wire

Ambient temperature
 Fixed installation

Technical data

Ethernet for rail applications [94S]

CAT7
 4x2xAWG26/7; S/FTP
 4x 2x 0.14 mm²
 7x 0.16 mm
 26
 6.6 mm
 ≤ 145 Ω/km
 Tinned copper braided shield

Aluminum-lined polyester foil

Tin-plated Cu litz wires
 PE-X
 black
 White-blue, white-orange,
 white-green, white-brown

[°C]

-40 ... 80

**Assembled cables,
Ethernet hybrid, 4+4-pos.,
shielded, CAT5**



Ethernet

Open cable end



OE

M12 male connector



MSY SCO

M12 male connector



MSY SCO

M12 flush-type
female connector,
rear mounting



FSBPY

Ordering data

Ordering data

Order No.

Order No.

1 m	1407487
2 m	1407488
5 m	1407489
10 m	1407490
Variable	1408642

0.5 m	1407504
1 m	1407505
2 m	1407506
5 m	1407507

1 m	1407491
2 m	1407492
5 m	1407493
10 m	1407494
Variable	1408641

Notes:

For H, Y, and T distributors, see page 436

**Information for products with
fixed cable length:**

Products with fixed cable length are produced with the **94H** cable type and are available from stock.

**Ordering data for cables with
variable cable length:**

For a 4.5 m long type 94H network cable with **M12 male connector, straight** and **RJ45 connector, IP20**, the ordering data is as follows:

Order No.	Cable type	Length [m] Max. 40 m
1408717	94H	4.5
Increments: 0.2 ... 3 m = 0.1 m > 3 m = 0.5 m		

Minimum order qty:
25 pcs.

Pin M12	Wire color	Signal
1	WHOG	TD+
2	OG	TD-
3	WHGN	RD+
4	GN	RD-
5	BU	
6	WH	
7	BN	
8	BK	

Transmission characteristics (category)
 Cable structure
 Conductor cross section for signal [mm²]
 Conductor structure for signal
 AWG signal line
 Conductor cross section for power [mm²]
 Conductor structure for power
 AWG power supply
 Cable diameter
 Type of shield

Conductor material
 Outer sheath material
 Color of outer sheath
 Color, single wire

Ambient temperature	
Fixed installation	[°C]
Flexible installation	[°C]

Technical data

Ethernet hybrid [94H]
 CAT5
 1x4xAWG26+1x4xAWG20
 0.15
 19x 0.10 mm
 26
 0.6
 19x 0.20 mm
 20
 7.6 mm
 Tinned copper braided shield

Bare Cu litz wires
 PUR
 black RAL 9005
 White/orange, orange,
 white/green, green, white, blue,
 brown, black

Fiber optics patch cables

Connectors:

- LC
- SC duplex
- B-FOC (ST®)

Fixed lengths:

- 1 m
- 2 m
- 5 m

Fiber types:

- Single-mode fiberglass (SM)

Sheath colors:

- Single-mode: yellow

Technical Data:

- Halogen-free
- Flame-retardant
- No corrosive or toxic fumes
- External dimensions: 2.8 mm x 5.7 mm



LC connector

ERC

Cable, properties	
Individual wire diameter	900 µm
Outer sheath, material	FRNC
External sheath, strain relief elements	Non-metallic, aramide fiber
Lateral pressure, long-term	60.00 N/cm
Tensile strength short-term/long-term	600 N
Halogen-free	In accordance with IEC 60754-2
General data	
Ambient temperature (storage/transport)	-25°C ... 70°C
Ambient temperature (installation)	-5°C ... 50°C
Ambient temperature (operation)	-5°C ... 70°C

Technical data		
Individual wire diameter	900 µm	
Outer sheath, material	FRNC	
External sheath, strain relief elements	Non-metallic, aramide fiber	
Lateral pressure, long-term	60.00 N/cm	
Tensile strength short-term/long-term	600 N	
Halogen-free	In accordance with IEC 60754-2	
Ambient temperature (storage/transport)	-25°C ... 70°C	
Ambient temperature (installation)	-5°C ... 50°C	
Ambient temperature (operation)	-5°C ... 70°C	

Description	Length of cable
FO patch cable with single mode fiberglass (OS1) - LC plug to LC, SC duplex or B-FOC plug	1 m 2 m 5 m
FO patch cable with single mode fiberglass (OS1) - SC duplex plug to SC duplex or B-FOC plug	1 m 2 m 5 m
FO patch cable with single mode fiberglass (OS1) - B-FOC plug to B-FOC plug	1 m 2 m 5 m

Ordering data		
Type	Order No.	Pcs./Pkt.
FL SM PATCH 1,0 LC-LC	2989187	1
FL SM PATCH 2,0 LC-LC	2989284	1
FL SM PATCH 5,0 LC-LC	2901826	1



SC duplex connector



B-FOC connector

ERIC

Technical data
900 µm
FRNC
Non-metallic, aramide fiber
60.00 N/cm
600 N
In accordance with IEC 60754-2
-25°C ... 70°C
-5°C ... 50°C
-5°C ... 70°C

Technical data
900 µm
FRNC
Non-metallic, aramide fiber
60.00 N/cm
600 N
In accordance with IEC 60754-2
-25°C ... 70°C
-5°C ... 50°C
-5°C ... 70°C

Ordering data		
Type	Order No.	Pcs./Pkt.
FL SM PATCH 1,0 LC-SC	2989190	1
FL SM PATCH 2,0 LC-SC	2989297	1
FL SM PATCH 5,0 LC-SC	2901827	1
FL SM PATCH 1,0 SC-SC	2901829	1
FL SM PATCH 2,0 SC-SC	2901830	1
FL SM PATCH 5,0 SC-SC	2901831	1

Ordering data		
Type	Order No.	Pcs./Pkt.
FL SM PATCH 1,0 LC-ST	2989242	1
FL SM PATCH 2,0 LC-ST	2989349	1
FL SM PATCH 5,0 LC-ST	2901828	1
FL SM PATCH 1,0 SC-ST	2901832	1
FL SM PATCH 2,0 SC-ST	2901833	1
FL SM PATCH 5,0 SC-ST	2901834	1
FL SM PATCH 1,0 ST-ST	2901836	1
FL SM PATCH 2,0 ST-ST	2901837	1
FL SM PATCH 5,0 ST-ST	2901838	1

Data connectors and cables

Network components – Assembled fiber optic cables

Fiber optic outdoor cables, sold by the meter

- Robust round cables for outdoor installation
- Ozone and UV resistant
- Watertight lengthwise
- Integrated vapor barrier and rodent-proof scrim



GOF fiber type



PCF fiber type

	Technical data		Technical data	
	FOC-OE-OE-GB01/...	FOC-OE-OE-GB02/...	FOC-OE-OE-GB03/...	FOC-OE-OE-HB01/...
Cable data				
Cable abbreviation in accordance with IEC 61977:2010	02-G50/FJ(ZNG)H-...22	02-G50/FJ(ZN)Z-...22	04-G50/FJ(ZNG)H-...22	02-H200/VJ(ZNG)H-...22
Fibers	50/125 µm OM2	50/125 µm OM2	50/125 µm OM2	200/230 µm
Attenuation, typical	2.7 dB/km (at 850 nm); 0.8 dB/km (at 1300 nm)	2.7 dB/km (at 850 nm); 0.8 dB/km (at 1300 nm)	2.7 dB/km (at 850 nm); 0.8 dB/km (at 1300 nm)	10 dB/km (at 660 nm), 8 dB/km (at 850 nm)
Outer sheath				
Material	PE	PUR	PE	PE
Color	black	black	black	black
Strain relief elements	Aramide/glass fibers	Non-metallic, aramide fiber	Aramide/glass fibers	Aramide/glass fibers
Diameter	7.5 mm	7.5 - 8 mm	9 mm	7.5 mm
Individual wire				
Color	Black/orange	Black/orange	Black/orange	Black/orange
Diameter	2.2 mm	2.2 mm	2.15 mm	2.2 mm
Strain relief elements	Non-metallic, aramide fibers	Non-metallic, aramide fibers	Non-metallic, aramide fibers	Non-metallic, aramide fibers
General data				
Weight	59.00 kg/km	46.00 kg/km	90.00 kg/km	67.00 kg/km
Ambient temperature (operation)	-40°C ... 70°C	-40°C ... 85°C	-40°C ... 70°C	-20°C ... 70°C
Ambient temperature (storage/transport)	-45°C ... 70°C	-45°C ... 85°C	-40°C ... 70°C	-25°C ... 70°C
Ambient temperature (installation)	-20°C ... 60°C	-20°C ... 60°C	-20°C ... 60°C	-10°C ... 60°C
Halogen-free:	In acc. with IEC 60754-1/2	In acc. with IEC 60754-1/2	In acc. with IEC 60754-1/2	In acc. with IEC 60754-1/2

	Ordering data			Ordering data		
	Type	Order No.	Pcs./Pkt.	Type	Order No.	Pcs./Pkt.
Description						
GOF outdoor cable, 2-wire, full breakout cable for fixed installation	FOC-OE-OE-GB01/...	1406429	1			
GOF outdoor cable, 2-wire, full breakout cable for flexible installation	FOC-OE-OE-GB02/...	1406430	1			
GOF outdoor cable, 4-wire, full breakout cable for fixed installation	FOC-OE-OE-GB03/...	1406431	1			
PCF outdoor cable, 2-wire, full breakout cable for fixed installation	FOC-OE-OE-HB01/...	1406432	1			

Ordering example for cables by the meter:

For a 34.0 m long FO outdoor type GB02 cable, the ordering data is as follows:

Order No.	Length [m] Max. 1000 m
1406430	34
	Increment: 1 m ... 1000 m = 1 m

Assembled FO cables

- Universal installation cables for fixed installation indoors
- 2.2 mm individual wires made from extremely hard-wearing polyvinyl chloride (PVC)
- Ozone and UV resistant
- PVC outer cable sheath
- PROFINET type B

Ethernet



Assembled FO cable, SC-RJ to BFOC (ST®)

Technical data

FOC-SJ:14-ST/.../.../...

Cable data	
Cable abbreviation in accordance with IEC 61977:2010	AT-V(ZN)YY 2K200/230 HCS
Fibers	200/230 µm
Attenuation, typical	10 dB/km (at 660 nm), 8 dB/km (at 850 nm)
Outer sheath	
Material	PVC
Color	green
Strain relief elements	Non-metallic, aramide fiber
Diameter	6.7 - 7.7 mm
Individual wire	
Color	Black and orange with arrow labeling
Diameter	2.2 mm ±0.1 mm
Strain relief elements	Non-metallic, aramide fibers
General data	
Weight	45.00 kg/km
Ambient temperature (operation)	-30°C ... 70°C
Ambient temperature (storage/transport)	-40°C ... 70°C
Ambient temperature (installation)	-5°C ... 50°C
Halogen-free:	yes

Ordering data

Description	Type	Order No.	Pcs./Pkt.
Assembled FO cable , PROFINET cable type B with SC-RJ Push-Pull metal housing to BFOC (ST®) male connector		1417723	1
	FOC-SJ:14-ST/.../.../...		

Ordering example for a configured cable:

For an HCS cable, fitted with an SC-RJ push-pull male connector on one end and a B-FOC(ST®) male connector, IP20 on the other end, and a length of 15 m, the ordering data is as follows:

Order No.	Length [m]
1417723	Max. 2000 m
	15
	Increment:
	1 m ... 5 m = 0.25 m
	5 m ... 1000 m = 1 m

Network components – Assembled fiber optic cables

Universal PROFINET B PCF cables for free assembly, type PN-B-PCF-1018

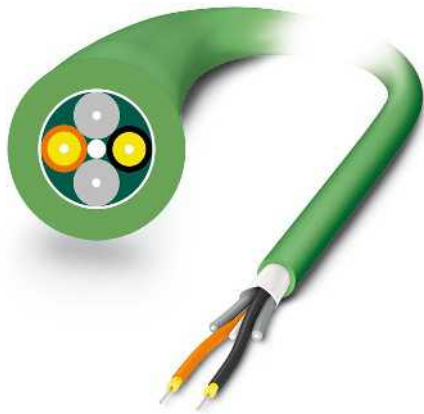

- Universal installation cables for fixed installation indoors
- 2.2 mm individual wires made from extremely hard-wearing polyvinyl chloride (PVC)
- Ozone and UV resistant
- PVC outer cable sheath
- PROFINET type B

Ethernet



Free end



OE

FSMA connector, IP20



FSMA

SC-RJ connectors, IP20



SCRJ

SC duplex connector, IP20



SCDUP

B-FOC (ST®) connector, IP20



BFOC

LC male connector



LC

Push/pull SC-RJ, plastic



PPCPL

Push/pull SC-RJ, metal



PPCME

Free end	FSMA connector, IP20	SC-RJ connector, IP20
OE	FSMA	SCRJ
Ordering data	Ordering data	Ordering data
Order No.	Order No.	Order No.
By the meter 2313766	Variable 2901556	Variable 2901556
Variable 2901556	Variable 2901556	Variable 2901556
Variable 2901556	Variable 2901556	Variable 2901556
Variable 2901556	Variable 2901556	Variable 2901556
Variable 2901556	Variable 2901556	Variable 2901556
Variable 2901556	Variable 2901556	Variable 2901556
Variable 1402190	Variable 1402190	Variable 1402190
Variable 1402190	Variable 1402190	Variable 1402190

Ordering example for configured cable:

For an HCS cable, fitted at one end with an SC-RJ connector and a B-FOC(ST®) connector, IP20 at the other end, and a length of 15 m, the ordering data as follows:

Order No.	Connector 1	Connector 2	Length [m]
2901556	SCRJ	BFOC	15

Length:	Min. 1 m Max. 2000 m
Increment:	0.25 m 1 m ... 5 m 1 m 5 m ... 2000 m





Ordering example for cable sold by the meter:

For an HCS cable with a length of 70 m, the ordering data is as follows:

Order No.	Length [m]
2313766	70

Length:	Min. 1 m Max. 2000 m/cable drum
Increment:	0.25 m 1 m ... 5 m 1 m 5 m ... 2000 m

Network components – Assembled fiber optic cables

SC duplex connector, IP20	B-FOC (ST®) connector, IP20	LC connector	Push/pull SC-RJ, plastic	Push/pull SC-RJ, metal
				
SCDUP	BFOC	LC	PPCPL	PPCME
Ordering data	Ordering data	Ordering data	Ordering data	Ordering data
Order No.	Order No.	Order No.	Order No.	Order No.

Variable 2901556	Variable 2901556	Variable 2901556	Variable 1402190	Variable 1402190
Variable 2901556	Variable 2901556	Variable 2901556	Variable 1402190	Variable 1402190

Variable 2901556	Variable 2901556	Variable 2901556	Variable 1402190	Variable 1402190
Variable 2901556	Variable 2901556	Variable 2901556	Variable 1402190	Variable 1402190

Variable 2901556	Variable 2901556	Variable 2901556	Variable 1402190	Variable 1402190
Variable 2901556	Variable 2901556	Variable 2901556	Variable 1402190	Variable 1402190

Variable 1402190	Variable 1402190	Variable 1402190	Variable 1402190	Variable 1402190
Variable 1402190	Variable 1402190	Variable 1402190	Variable 1402190	Variable 1402190

Technical data	
Cable data	
Cable abbreviation in accordance with IEC 61977:2010	AT-V(ZN)YY 2K200/230 HCS
Fibers	HCS, 200/230 µm
Attenuation, typical	10 dB/km
Outer sheath	
Material	PVC
Color	green
Diameter	6.7 - 7.7 mm
Strain relief elements	Non-metallic, aramide fiber
Individual wire	
Structure	PVC
Color	Black and orange with arrow labeling
Diameter	2.2 mm ±0.1 mm
Strain relief elements	Non-metallic, aramide fibers
General data	
Weight	45 kg/km
Ambient temperature (operation)	-40°C ... 90°C
Ambient temperature (storage/transport)	-40°C ... 90°C
Ambient temperature (installation)	-5°C ... 50°C
Halogen-free:	-

Network components – Assembled fiber optic cables

Robust PCF cables for free assembly, type PCF-RUGGED-1014

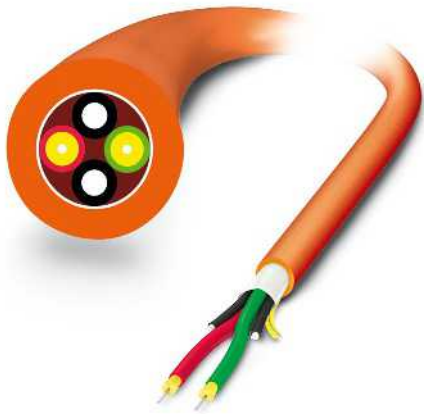

- Robust installation cables for indoor use
- Highly tear-resistant aramid strain relief elements
- 2.9 mm individual wires made from highly flexible FRNC material
- Halogen-free, ozone and UV resistant
- Robust polyurethane (PUR) outer cable sheath

	Free end	FSMA connector, IP20	SC-RJ connector, IP20
	OE	FSMA	SCRJ
	Ordering data	Ordering data	Ordering data
	Order No.	Order No.	Order No.
Free end			
	OE		
FSMA connector, IP20			
	FSMA		
SC-RJ connectors, IP20			
	SCRJ		
SC duplex connector, IP20			
	SCDUP		
B-FOC (ST®) connector, IP20			
	BFOC		
LC connector			
	LC		
Push/pull SC-RJ, plastic			
	PPCPL		
Push/pull SC-RJ, metal			
	PPCME		
SC-RJ male connector, IP67			
	IP67		
	By the meter 2799885	Variable 2901555	Variable 2901555
	Variable 2901555	Variable 2901555	Variable 2901555
	Variable 2901555	Variable 2901555	Variable 2901555
	Variable 2901555	Variable 2901555	Variable 2901555
	Variable 2901555	Variable 2901555	Variable 2901555
	Variable 2901555	Variable 2901555	Variable 2901555
	Variable 1402191	Variable 1402191	Variable 1402191
	Variable 1402191	Variable 1402191	Variable 1402191
	Variable 1402191	Variable 1402191	Variable 1402191
	Variable 1402191	Variable 1402191	Variable 1402191

Ordering example for configured cable:

For an HCS cable, fitted at one end with an SC-RJ connector and a B-FOC(ST®) connector, IP20 at the other end, and a length of 15 m, the ordering data is as follows:

Order No.	Connector 1	Connector 2	Length [m]
2901555	SCRJ	BFOC	15

Length:	Min. 1 m Max. 2000 m
Increment:	0.25 m 1 m ... 5 m 1 m 5 m ... 2000 m







Ordering example for cable sold by the meter:

For an HCS cable with a length of 70 m, the ordering data is as follows:

Order No.	Length [m]
2799885	70

Length:	Min. 1 m Max. 2000 m/cable drum
Increment:	0.25 m 1 m ... 5 m 1 m 5 m ... 2000 m

Network components – Assembled fiber optic cables

SC duplex connector, IP20	B-FOC (ST®) connector, IP20	LC connector	Push/pull SC-RJ, plastic	Push/pull SC-RJ, metal	SC-RJ male connector, IP67
					
SCDUP	BFOC	LC	PPCPL	PPCME	IP67
Ordering data	Ordering data	Ordering data	Ordering data	Ordering data	Ordering data
Order No.	Order No.	Order No.	Order No.	Order No.	Order No.

Variable 2901555	Variable 2901555	Variable 2901555	Variable 1402191	Variable 1402191	Variable 1402191
Variable 2901555	Variable 2901555	Variable 2901555	Variable 1402191	Variable 1402191	Variable 1402191

Variable 2901555	Variable 2901555	Variable 2901555	Variable 1402191	Variable 1402191	Variable 1402191
Variable 2901555	Variable 2901555	Variable 2901555	Variable 1402191	Variable 1402191	Variable 1402191

Variable 2901555	Variable 2901555	Variable 2901555	Variable 1402191	Variable 1402191	Variable 1402191
Variable 2901555	Variable 2901555	Variable 2901555	Variable 1402191	Variable 1402191	Variable 1402191

Variable 1402191	Variable 1402191	Variable 1402191	Variable 1402191	Variable 1402191	Variable 1402191
Variable 1402191	Variable 1402191	Variable 1402191	Variable 1402191	Variable 1402191	Variable 1402191

Variable 1402191	Variable 1402191	Variable 1402191	Variable 1402191	Variable 1402191	Variable 1402191
-------------------------	-------------------------	-------------------------	-------------------------	-------------------------	-------------------------

	Technical data
Cable data	
Cable abbreviation in accordance with IEC 61977:2010	I-VH11Y 2K200/230 HCS
Fibers	HCS, 200/230 µm
Attenuation, typical	10 dB/km
Outer sheath	
Material	PUR
Color	orange
Diameter	7.5 - 8.5 mm
Individual wire	
Structure	FRNC material
Color	Red/Green
Diameter	2.9 mm ±0.1 mm
Strain relief elements	Non-metallic, aramide fibers
General data	
Weight	54 kg/km
Ambient temperature (operation)	-40°C ... 70°C
Ambient temperature (storage/transport)	-40°C ... 70°C
Ambient temperature (installation)	-20°C ... 60°C

Network components – Assembled fiber optic cables

Zip cord fiberglass cables for assembly, OM1

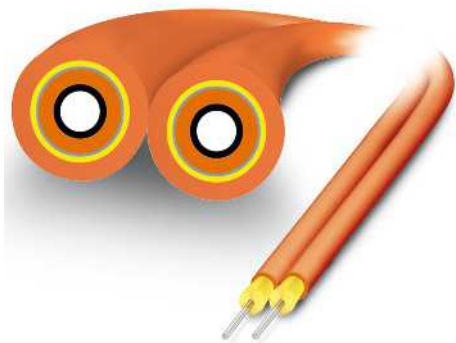

- Multimode patch cables for indoor installation
- Ideal for use in distributor systems and for connecting termination devices
- 2.8 mm single elements made from halogen-free and flame-retardant material
- UL approval type OFNR (riser) for USA and Canada

	Free end	FSMA connector, IP20	SC duplex connector, IP20
	OE	FSMA	SCDUP
	Ordering data	Ordering data	Ordering data
	Order No.	Order No.	Order No.
Free end	Variable	1411566	
FSMA connector, IP20		1.00 m	1409855
		Variable	1406532
SC duplex connector, IP20		1.00 m	1409857
		Variable	1406536
		1.00 m	1413828
		Variable	1406536
		Variable	1413790
B-FOC (ST®) connector, IP20		1.00 m	1409856
		Variable	1406535
LC duplex connector, IP20		1.00 m	1413825
		Variable	1413787
		1.00 m	1413827
		Variable	1413789

Ordering example for a configured cable:

For a 15 m long zip cord fiberglass cable, fitted with an FSMA male connector, IP20, at one end and an SC Duplex connector, IP20, at the other end, the ordering data is as follows:

Order No.	Length [m]
1406536	15

Length:	Min. 1 m	Max. 1000 m
Increment:	1 m	1 m ... 1000 m

B-FOC (ST®) connector, IP20



BFOC

Ordering data

Order No.

LC duplex connector, IP20



LC

Ordering data

Order No.

1.00 m **1409856**

Variable **1406535**

1.00 m **1413830**

Variable **1413791**

1.00 m **1413832**

Variable **1413821**

1.00 m **1413831**

Variable **1413792**

1.00 m **1413825**

Variable **1413787**

1.00 m **1413827**

Variable **1413789**

1.00 m **1413831**

Variable **1413792**

1.00 m **1413826**

Variable **1413788**

Technical data

Cable data

Cable abbreviation in accordance with IEC 61977:2010

Fibers

Attenuation, typical

I-V(ZN)H

-

3.2 dB/km (at 850 nm);
0.9 dB/km (at 1300 nm)

Outer sheath

Material

Color

Diameter

Strain relief elements

Individual wire

Structure

Color

Diameter

General data

Weight

Ambient temperature (operation)

Ambient temperature (storage/transport)

Ambient temperature (installation)

Halogen-free:

-

orange

2.8 - 5.7 mm

-

-

-

-

-

15.80 kg/km

-10°C ... 60°C

-10°C ... 60°C

-5°C ... 50°C

In accordance with IEC 60754-2

Data connectors and cables

Network components – Assembled fiber optic cables

Zip cord fiberglass cables for assembly, OM2

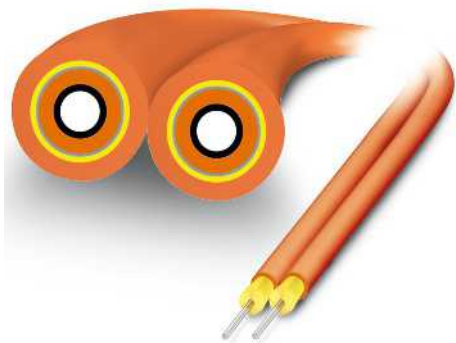

- Multimode patch cables for indoor installation
- Ideal for use in distributor systems and for connecting termination devices
- 2.8 mm single elements made from halogen-free and flame-retardant material
- UL approval type OFNR (riser) for USA and Canada

	Free end	SC-RJ connector, IP20	SC duplex connector, IP20
	OE	SCRJ	SCDUP
	Ordering data	Ordering data	Ordering data
	Order No.	Order No.	Order No.
Free end			
	Variable	1411561	
SC-RJ connector, IP20			
		1.00 m 1409813 2.00 m 1400697	1.00 m 1409810 2.00 m 1400690
SCRJ		Variable 1405703	Variable 1405700
SC duplex connector, IP20			1.00 m 1409798 2.00 m 1400685
			Variable 1405697
SCDUP			
B-FOC (ST®) connector, IP20			
BFOC			
LC duplex connector, IP20			1.00 m 1409790 2.00 m 1400639
			Variable 1405691
LC			

Ordering example for a configured cable:

For a 15 m long zip cord fiberglass cable, fitted with an SC duplex connector, IP20, at one end and an SC-RJ connector, IP20, at the other end, the ordering data is as follows:

Order No.	Length [m]
1405700	15

Length:	1 m, minimum 1000 m, maximum
Increment:	1 m 1 m ... 1000 m

B-FOC (ST®) connector,
IP20

LC duplex connector,
IP20



BFOC

LC

Ordering data

Ordering data

Order No.

Order No.

1.00 m **1409822**
2.00 m **1400706**

1.00 m **1409793**
2.00 m **1400682**

Variable **1405710**

Variable **1405694**

1409819
1400703

Variable **1405708**

1.00 m **1409824**
2.00 m **1404768**

Variable **1405712**

1.00 m **1409816**
2.00 m **1400701**

1.00 m **1409787**
2.00 m **1400604**

Variable **1405706**

Variable **1405688**

Technical data

Cable data

Cable abbreviation in accordance with IEC 61977:2010

I-V(ZN)H

Fibers

-

Attenuation, typical

2.7 dB/km (at 850 nm);
0.8 dB/km (at 1300 nm)

Outer sheath

Material

-

Color

orange

Diameter

2.8 - 5.7 mm

Strain relief elements

-

Individual wire

Structure

-

Color

-

Diameter

900 µm

General data

Weight

15.80 kg/km

Ambient temperature (operation)

-10°C ... 60°C

Ambient temperature (storage/transport)

-10°C ... 60°C

Ambient temperature (installation)

-5°C ... 50°C

Halogen-free:

In acc. with IEC 60754-1/2

Data connectors and cables

Network components – Assembled fiber optic cables

Zip cord fiberglass cables for assembly, OM3

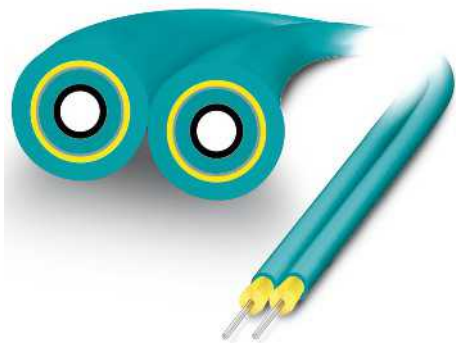

- Multimode patch cables for indoor installation
- Ideal for use in distributor systems and for connecting termination devices
- 2.8 mm single elements made from halogen-free and flame-retardant material
- UL approval type OFNR (riser) for USA and Canada
- Low-bend fiber
- Data rate: up to 10 Gbps up to 300 m

Free end	SC-RJ male connector, IP20	SC duplex connector, IP20
OE	SCRJ	SCDUP
Ordering data	Ordering data	Ordering data
Order No.	Order No.	Order No.
Free end		
OE		
SC-RJ connector, IP20		
SCRJ		
SC duplex connector, IP20		
SCDUP		
LC duplex connector, IP20		
LC		
Variable	1411563	
	1.00 m 1409814	1.00 m 1409811
	2.00 m 1400699	2.00 m 1400691
	Variable 1405704	Variable 1405701
		1.00 m 1409799
		2.00 m 1400688
		Variable 1405698
		1.00 m 1409791
		2.00 m 1400673
		Variable 1405692

Ordering example for a configured cable:

For a 15 m long zip cord fiberglass cable, fitted with an SC duplex connector, IP20, at one end and an SC-RJ connector, IP20, at the other end, the ordering data is as follows:

Order No.	Length [m]
1405701	15

Length:	1 m, minimum 1000 m, maximum
Increment:	1 m 1 m ... 1000 m

B-FOC (ST®) connector, IP20



BFOC

Ordering data

Order No.

LC duplex connector, IP20



LC

Ordering data

Order No.

1.00 m **1409823**
2.00 m **1400711**

Variable **1405711**

1.00 m **1409821**
2.00 m **1400705**

Variable **1405709**

1.00 m **1409818**
2.00 m **1400702**

Variable **1405707**

1.00 m **1409796**
2.00 m **1400683**

Variable **1405695**

1.00 m **1409788**
2.00 m **1400621**

Variable **1405695**

Technical data

Cable data

Cable abbreviation in accordance with IEC 61977:2010

Fibers

Attenuation, typical

Smallest bending radius, fixed installation

Smallest bending radius, movable installation

Outer sheath

Material

Color

Diameter

Strain relief elements

Individual wire

Structure

Color

Diameter

General data

Weight

Ambient temperature (operation)

Ambient temperature (storage/transport)

Ambient temperature (installation)

Halogen-free:

I-V(ZN)H

-

2.5 dB/km (at 850 nm),
0.7 dB/km (at 1300 nm)

15 mm

30 mm

-

aqua

2.8 - 5.7 mm

-

-

-

-

15.80 kg/km

-10°C ... 60°C

-10°C ... 60°C

-5°C ... 50°C

In acc. with IEC 60754-1/2

Data connectors and cables

Network components – Assembled fiber optic cables

Zip cord fiberglass cables for assembly, OM4

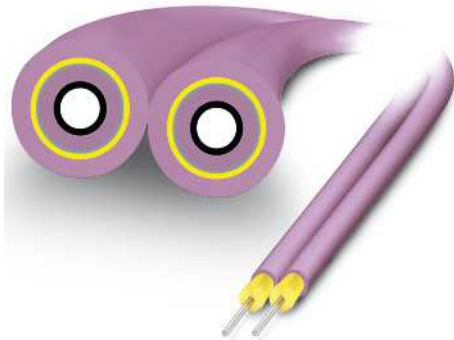

- Multimode patch cables for indoor installation
- Ideal for use in distributor systems and for connecting termination devices
- 2.8 mm single elements made from halogen-free and flame-retardant material
- UL approval type OFNR (riser) for USA and Canada
- Low-bend fiber
- Data rate: up to 10 Gbps up to 550 m

Free end	SC-RJ connector, IP20	SC duplex connector, IP20
OE	SCRJ	SCDUP
Ordering data	Ordering data	Ordering data
Order No.	Order No.	Order No.
Free end		
OE		
SC-RJ connector, IP20		
SCRJ		
SC duplex connector, IP20		
SCDUP		
LC duplex connector, IP20		
LC		
Variable	1411564	
	1.00 m 1409815	1.00 m 1409812
	2.00 m 1400700	2.00 m 1400695
	Variable 1405705	Variable 1405702
		1.00 m 1409801
		2.00 m 1400689
		Variable 1405699
		1.00 m 1409792
		2.00 m 1400681
		Variable 1405693

Ordering example for a configured cable:

For a 15 m long zip cord fiberglass cable, fitted with an SC duplex connector, IP20, at one end and an SC-RJ connector, IP20, at the other end, the ordering data is as follows:

Order No.	Length [m]
1405702	15

Length:	1 m, minimum 1000 m, maximum
Increment:	1 m 1 m ... 1000 m

LC duplex connector,
IP20

LC

Ordering data

Order No.

1.00 m	1409797
2.00 m	1400684

Variable	1405696
----------	---------

1.00 m	1409789
2.00 m	1400622

Variable	1405690
----------	---------

Technical data

Cable data

Cable abbreviation in accordance with IEC 61977:2010	I-V(ZN)H
Fibers	-
Attenuation, typical	2.5 dB/km (at 850 nm), 0.7 dB/km (at 1300 nm)
Smallest bending radius, fixed installation	15 mm
Smallest bending radius, movable installation	30 mm
Outer sheath	
Material	-
Color	Violet
Diameter	2.8 - 5.7 mm
Strain relief elements	-
Individual wire	
Structure	-
Color	-
Diameter	-
General data	
Weight	15.80 kg/km
Ambient temperature (operation)	-10°C ... 60°C
Ambient temperature (storage/transport)	-10°C ... 60°C
Ambient temperature (installation)	-5°C ... 50°C
Halogen-free:	In acc. with IEC 60754-1/2

Connectors, for assembly



INTERBUS



PROFIBUS DP



	Technical data	
	Push-in connection IEC 61076-2-101	Screw connection IEC 61076-2-101
M12 circular connector in accordance with:		
Degree of pollution	3	3
Degree of protection	IP65 / IP67	IP67
Connection method	Push-in connection	Screw connection
Connection cross section	0.14 mm ² ... 0.75 mm ²	0.25 mm ² ... 0.75 mm ²
External cable diameter	4 mm ... 8 mm	6.5 mm ... 8.5 mm
Electrical data		
Rated voltage	48 V AC / 60 V DC	48 V AC / 60 V DC
Rated current	4 A	4 A
Insulation resistance	≥ 100 MΩ	≥ 100 MΩ
Material data		
Contact material	CuSn	CuZn
Contact surface material	Ni/Au	Au
Contact carrier material	PA 6.6	PA 6.6
Flammability rating in accordance with UL 94	V0	HB
Coding	B - inverse	B - inverse
Number of positions	5	5
Temperature data		
Male connector/female connector [°C]	-40 ... 85	-40 ... 85



	Technical data	
	Push-in connection IEC 61076-2-101	Screw connection IEC 61076-2-101
M12 circular connector in accordance with:		
Degree of pollution	3	3
Degree of protection	IP65 / IP67	IP67
Connection method	Push-in connection	Screw connection
Connection cross section	0.14 mm ² ... 0.75 mm ²	0.25 mm ² ... 0.75 mm ²
External cable diameter	4 mm ... 8 mm	6.5 mm ... 8.5 mm
Electrical data		
Rated voltage	48 V AC / 60 V DC	48 V AC / 60 V DC
Rated current	4 A	4 A
Insulation resistance	≥ 100 MΩ	≥ 100 MΩ
Material data		
Contact material	CuSn	CuZn
Contact surface material	Ni/Au	Au
Contact carrier material	PA 6.6	PA 6.6
Flammability rating in accordance with UL 94	V0	HB
Coding	B - inverse	B - inverse
Number of positions	2	5
Temperature data		
Male connector/female connector [°C]	-40 ... 85	-40 ... 85

Ordering data

Description	Order No.	Pcs./Pkt.	Order No.	Pcs./Pkt.
	Push-in connection		Screw connection	
Connectors				
Female, straight	1424676	1	1507777	1
Male, straight	1424674	1	1507764	1
Female, angled	1424677	1	1430420	1
Male, angled	1424675	1	1430417	1
Cable connector , shielded, color-coded and numbered connection area				

Description	Order No.	Pcs./Pkt.	Order No.	Pcs./Pkt.
	Push-in connection		Screw connection	
Connectors				
Female, straight	1424680	1	1507777	1
Male, straight	1424678	1	1507764	1
Female, angled	1424681	1	1430420	1
Male, angled	1424679	1	1430417	1
Cable connector , shielded, color-coded and numbered connection area				

Ordering data

Description	Order No.	Pcs./Pkt.	Order No.	Pcs./Pkt.
	Push-in connection		Screw connection	
Connectors				
Female, straight	1424680	1	1507777	1
Male, straight	1424678	1	1507764	1
Female, angled	1424681	1	1430420	1
Male, angled	1424679	1	1430417	1
Cable connector , shielded, color-coded and numbered connection area				

Accessories

Description	Type	Order No.	Pcs./Pkt.
Stripping tool , for multiple-stage repositioning of shielded conductors	VS-CABLE-STRIP-VARIO	1657407	1

Description	Type	Order No.	Pcs./Pkt.
Stripping tool , for multiple-stage repositioning of shielded conductors	VS-CABLE-STRIP-VARIO	1657407	1

Description	Type	Order No.	Pcs./Pkt.
Stripping tool , for multiple-stage repositioning of shielded conductors	VS-CABLE-STRIP-VARIO	1657407	1



PROFIBUS DP, PROFIBUS PA



CANopen®, DeviceNet™



CC-Link

ERC

ERC

ERC

Technical data	
PROFIBUS DP in accordance with IEC 61076-2-101 3 IP65 / IP67 Insulation displacement connection 0.25 mm ² ... 0.75 mm ² 5 mm ... 9.7 mm	PROFIBUS PA in accordance with IEC 61076-2-101 3 IP65 / IP67 Insulation displacement connection 0.25 mm ² ... 0.75 mm ² 5 mm ... 9.7 mm
48 V AC / 60 V DC 4 A ≥ 100 MΩ	30 V DC 4 A ≥ 100 MΩ
CuSn Ni/Au PA 6.6 V0 B - inverse 2	CuSn Ni/Au PA 6.6 V0 A - standard 2
-40 ... 85	-40 ... 85

Technical data	
Push-in connection IEC 61076-2-101 3 IP65 / IP67 Push-in connection 0.14 mm ² ... 0.75 mm ² 4 mm ... 8 mm	Insulation displacement connection in accordance with IEC 61076-2-101 3 IP65 / IP67 Insulation displacement connection 0.14 mm ² ... 0.75 mm ² 5 mm ... 9.7 mm
48 V AC / 60 V DC 4 A ≥ 100 MΩ	48 V AC / 60 V DC 4 A ≥ 100 MΩ
CuSn Ni/Au PA 6.6 V0 A - standard 5	CuSn Ni/Au PA 6.6 V0 A - standard 5
-40 ... 85	-40 ... 85

Technical data	
Push-in connection IEC 61076-2-101 3 IP65 / IP67 Push-in connection 0.14 mm ² ... 0.75 mm ² 4 mm ... 8 mm	
48 V AC / 60 V DC 4 A ≥ 100 MΩ	
CuSn Ni/Au PA 6.6 V0 A - standard 4	
-40 ... 85	

Ordering data			
Order No.	Pcs./Pkt.	Order No.	Pcs./Pkt.
PROFIBUS DP		PROFIBUS PA	
1413932	1	1413934	1
1413931	1	1413933	1
1420426	1		

Ordering data			
Order No.	Pcs./Pkt.	Order No.	Pcs./Pkt.
Push-in connection		Insulation displacement connection	
1424672	1	1422760	1
1424670	1	1422759	1
1424673	1		
1424671	1		

Ordering data			
Order No.	Pcs./Pkt.	Order No.	Pcs./Pkt.
Push-in connection			
1424700	1		
1424699	1		

Accessories		
Type	Order No.	Pcs./Pkt.
VS-CABLE-STRIP-VARIO	1657407	1

Accessories		
Type	Order No.	Pcs./Pkt.
VS-CABLE-STRIP-VARIO	1657407	1

Accessories		
Type	Order No.	Pcs./Pkt.
VS-CABLE-STRIP-VARIO	1657407	1

Device connectors, shielded



With 0.5 m long litz wires,
front mounting



Technical data

M12 circular connector in accordance with:	IEC 61076-2-101
Degree of pollution	3
Degree of protection	IP67
Connection method	Individual wires
Electrical data	
Rated voltage	250 V
Rated current	4 A
Contact resistance	≤ 3 mΩ
Insulation resistance	≥ 100 MΩ
Material data	
Material contact/contact surface	CuZn / Ni/Au
Contact carrier material	PA66 GF
Flammability rating in accordance with UL 94	V0
Temperature data	
Male connector/female connector	-25 ... 85 [°C]

Ordering data

Description	Coding	Type	Order No.	Pcs./Pkt.
Device connectors				
Female	A - standard	SACC-E-M12FS-4CON-PG9/0,5 FFVA	1431429	1
Male	A - standard	SACC-E-M12MS-4CON-PG9/0,5 FFVA	1431432	1

Device connectors, with assembled cable, type 900



Rear mounting



Front mounting, can be positioned

ERC

Technical data

M16 fastening thread	Pg9 fastening thread
IEC 61076-2-101	IEC 61076-2-101
3	3
IP67	IP67
60 V	60 V
4 A	4 A
≤ 3 mΩ	≤ 3 mΩ
≥ 100 MΩ	≥ 100 MΩ
CuZn / Ni/Au	CuZn / Ni/Au
PA 6.6	PA 6.6
V0	V0
-25 ... 85	-25 ... 85

ERC

Technical data

M16 fastening thread
IEC 61076-2-101
3
IP67
60 V
4 A
≤ 3 mΩ
≥ 100 MΩ
CuZn / Ni/Au
PA 6.6
V0
-25 ... 85

Ordering data

Order No.	Pcs./Pkt.	Order No.	Pcs./Pkt.
M16 fastening thread		Pg9 fastening thread	
1534546	1	1437601	1
1534504	1	1437643	1
1534559	1	1437614	1
1534517	1	1437656	1
1534562	1	1437627	1
1534520	1	1437669	1
1534575	1	1437630	1
1534533	1	1437672	1

Ordering data

Order No.	Pcs./Pkt.	Order No.	Pcs./Pkt.
M16 fastening thread		M16 fastening thread	
1529742	1	1529629	1
1529755	1	1529755	1
1530223	1	1529768	1
1529726	1	1529726	1
1529771	1	1529771	1
1529739	1	1529739	1

M12 circular connector in accordance with:

Degree of pollution	
Degree of protection	
Electrical data	
Rated voltage	
Rated current	
Contact resistance	
Insulation resistance	
Material data	
Material contact/contact surface	
Contact carrier material	
Flammability rating in accordance with UL 94	
Temperature data	
Male connector/female connector	[°C]

Device connector, B-coded, with bus system cable, 6-wire, shielded, PUR, halogen-free, green outer sheath, 3 x 2 x 0.25 mm²

Description	Cable length
Female	0.5 m
Male	0.5 m
Female	1 m
Male	1 m
Female	2 m
Male	2 m
Female	5 m
Male	5 m

EMC hexagonal nut with fine toothing, for all device connectors with:

M16 fastening thread	1440164	10
Pg9 fastening thread	1440177	10

Device connectors, with assembled cable, type 910



Rear mounting



Front mounting, can be positioned

ERC

Technical data

M12 circular connector in accordance with:

Degree of pollution	3
Degree of protection	IP67
Electrical data	
Rated voltage	60 V
Rated current	4 A
Contact resistance	≤ 3 mΩ
Insulation resistance	≥ 100 MΩ
Material data	
Material contact/contact surface	CuZn / Ni/Au
Contact carrier material	PA 6.6
Flammability rating in accordance with UL 94	V0
Temperature data	
Male connector/female connector	[°C]

M16 fastening thread	Pg9 fastening thread
IEC 61076-2-101	IEC 61076-2-101
3	3
IP67	IP67
60 V	60 V
4 A	4 A
≤ 3 mΩ	≤ 3 mΩ
≥ 100 MΩ	≥ 100 MΩ
CuZn / Ni/Au	CuZn / Ni/Au
PA 6.6	PA 6.6
V0	V0
-25 ... 85	-25 ... 85

ERC

Technical data

M16 fastening thread
IEC 61076-2-101
3
IP67
60 V
4 A
≤ 3 mΩ
≥ 100 MΩ
CuZn / Ni/Au
PA 6.6
V0
-25 ... 85

Ordering data

Description	Cable length
Device connector , B-coded, with bus system cable, 2-wire, shielded, PUR, halogen-free, violet outer sheath, 1 x 2 x 0.25 mm ²	
Female	0.5 m
Male	0.5 m
Female	1 m
Male	1 m
Female	2 m
Male	2 m
Female	5 m
Male	5 m
EMC hexagonal nut with fine toothing, for all device connectors with:	
M16 fastening thread	
Pg9 fastening thread	

Order No.	Pcs./Pkt.	Order No.	Pcs./Pkt.
M16 fastening thread		Pg9 fastening thread	
1534384	1	1437449	1
1534342	1	1437481	1
1534397	1	1437452	1
1534355	1	1437494	1
1534407	1	1437465	1
1534368	1	1437504	1
1534410	1	1437478	1
1534371	1	1437517	1
1440164	10	1440177	10

Ordering data

Order No.	Pcs./Pkt.	Order No.	Pcs./Pkt.
M16 fastening thread			
1525597	1		
1525555	1		
1525607	1		
1525568	1		
1519574	1		
1519561	1		
1525610	1		
1525571	1		

Device connectors,
with assembled cable,
type 920

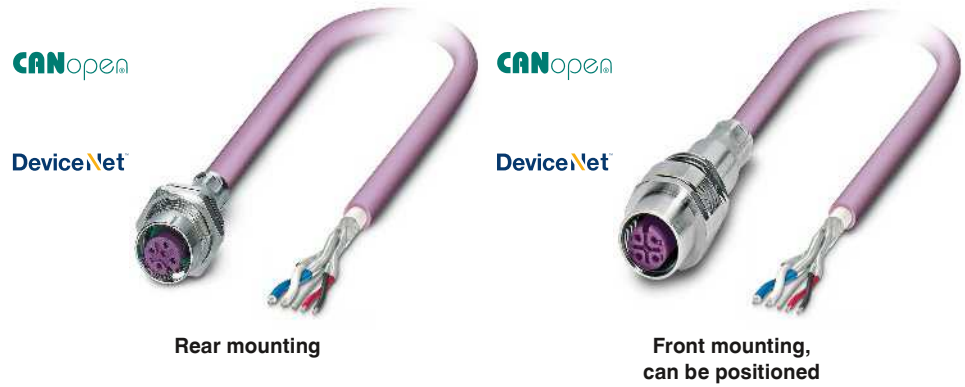

ERC

ERC



		Technical data				Technical data			
		M16 fastening thread		Pg9 fastening thread		M16 fastening thread			
		IEC 61076-2-101		IEC 61076-2-101		IEC 61076-2-101			
M12 circular connector in accordance with:		3		3		3			
Degree of pollution		IP67		IP67		IP67			
Electrical data									
Rated voltage		60 V		60 V		60 V			
Rated current		4 A		2 A		4 A			
Contact resistance		≤ 3 mΩ		≤ 3 mΩ		≤ 3 mΩ			
Insulation resistance		≥ 100 MΩ		≥ 100 MΩ		≥ 100 MΩ			
Material data									
Material contact/contact surface		CuZn / Ni/Au		CuZn / Ni/Au		CuZn / Ni/Au			
Contact carrier material		PA 6.6		PA 6.6		PA 6.6			
Flammability rating in accordance with UL 94		V0		V0		V0			
Temperature data									
Male connector/female connector		[-25 ... 85		[-25 ... 85		[-25 ... 85			
		Ordering data				Ordering data			
		Order No.	Pcs./Pkt.	Order No.	Pcs./Pkt.	Order No.	Pcs./Pkt.	Order No.	Pcs./Pkt.
		M16 fastening thread		Pg9 fastening thread		M16 fastening thread			
Description									
Cable length									
Device connector, A-coded, with bus system cable, 4-wire, shielded, PUR, halogen-free, violet outer sheath, 2 x 0.34 mm ² ; 2 x 0.25 mm ²									
Female	0.5 m	1534465	1	1437520	1	1525678	1		
Male	0.5 m	1534423	1	1437562	1	1525623	1		
Female	1 m	1534478	1	1437533	1	1525681	1		
Male	1 m	1534436	1	1437575	1	1525636	1		
Female	2 m	1534481	1	1437546	1	1525694	1		
Male	2 m	1534449	1	1437588	1	1525649	1		
Female	5 m	1534494	1	1437559	1	1525704	1		
Male	5 m	1534452	1	1437591	1	1525652	1		
EMC hexagonal nut with fine toothing, for all device connectors with:									
M16 fastening thread		1440164	10						
Pg9 fastening thread				1440177	10				

Fieldbus components – Assembled cables

Assembled cables, INTERBUS, M12

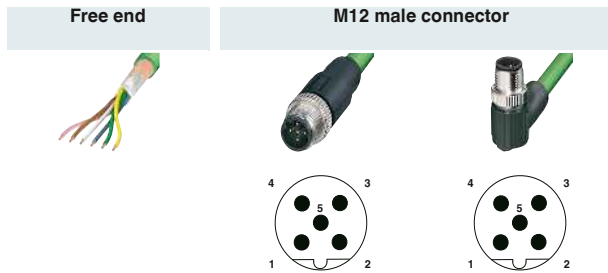
Notes:
For information about the cable qualities, see page 454

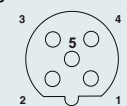

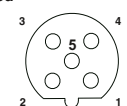
	Ordering data		Ordering data		Ordering data	
Free end	Order No.	Order No.	Order No.	Order No.	Order No.	Order No.
	Variable	2723123	2 m	1507065	Variable	1430970
			5 m	1507078		
			10 m	1507081		
			15 m	1507094		
M12 female connector, straight	Variable	1537983	Variable	1537983	Variable	1430970
			0.3 m	1507162		
			0.5 m	1507175		
			1 m	1507188		
			2 m	1507191		
			5 m	1507201		
			10 m	1507214		
			15 m	1507227		
	Variable	1538005	Variable	1538021	Variable	1431005
M12 female connector, angled	Variable	1430983	Variable	1430996	Variable	1431018
						
						

Ordering example for cable with connector assembly:

For an INTERBUS bus cable, straight M12 socket to straight M12 pin and 34.5 m cable length, the ordering data is as follows:

Order No.	Length [m]
1538021	40 m, maximum
	34.5
	Increments:
	0.2 ... 3.0 m = 0.1 m
	> 3.0 m = 0.5 m

Ordering example for cable without connector assembly:

For an INTERBUS bus cable with 34.5 m cable length, the ordering data is as follows:

Order No.	Length [m]
2723123	400 m, maximum
	34.5
	Increments:
	0.5 ... 400.0 m = 0.5 m

Technical data	
M12	
Rated voltage	48 V AC / 60 V DC
Rated current [A]	4
Contact resistance	≤ 5 mΩ
Contact material	CuSn
Contact surface material	Ni/Au
Material of grip body	TPU, hardly inflammable, self-extinguishing
Degree of protection	IP65 / IP67
Temperature data	
Male connector/female connector [°C]	-25 ... 90

**Assembled cables,
PROFIBUS DP, M12**

Notes:
 For information about the cable qualities, see page 454
 For H, Y, and T distributors, see page 436
 For termination resistors, see page 437

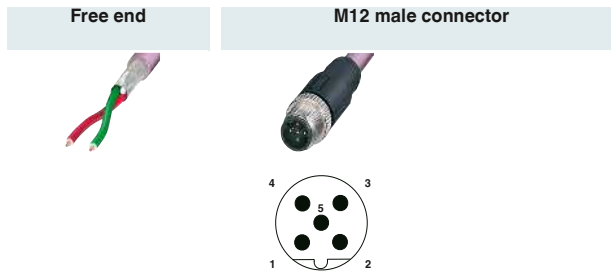

Free end	Ordering data		Ordering data		Ordering data	
	Order No.	Order No.	Order No.	Order No.	Order No.	Order No.
 M12 female connector, straight	2 m	1511491	2 m	1507243		
	5 m		5 m	1507256		
	10 m		10 m	1507269		
	15 m		15 m	1507272		
	Variable	1511491	Variable	1538047		
	0.3 m		0.3 m	1507340		
	0.5 m		0.5 m	1507353		
	1 m		1 m	1507366		
	2 m		2 m	1507379		
	5 m		5 m	1507382		
10 m		10 m	1507395			
15 m		15 m	1507405			
Variable	1538063	Variable	1538089			

**Ordering example for cable with
connector assembly:**

For a PROFIBUS bus cable, straight M12 socket to straight M12 pin and 34.5 m cable length, the ordering data is as follows:

Order No.	Length [m]
1538089	34.5
	40 m, maximum
	Increments:
	0.2 ... 3.0 m = 0.1 m
	> 3.0 m = 0.5 m

**Ordering example for cable without
connector assembly:**

For a PROFIBUS bus cable with 34.5 m cable length, the ordering data is as follows:

Order No.	Length [m]
1511491	34.5
	400 m, maximum
	Increments:
	0.5 ... 400.0 m = 0.5 m

Technical data	
M12	
Rated voltage	48 V AC / 60 V DC
Rated current [A]	4
Contact resistance	≤ 5 mΩ
Contact material	CuSn
Contact surface material	Ni/Au
Material of grip body	TPU, hardly inflammable, self-extinguishing
Degree of protection	IP65 / IP67
Temperature data	
Male connector/female connector [°C]	-25 ... 90

Data connectors and cables

Fieldbus components – Assembled cables

Assembled cables, PROFIBUS PA, M12 stainless steel

Notes:
For information about the cable qualities, see page 456
For H, Y, and T distributors, see page 436

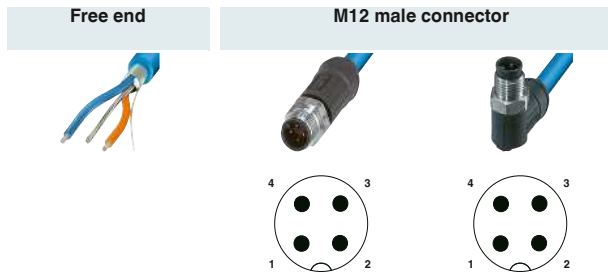

Free end	Order No.	Order No.	Order No.
	2 m	1419092	2 m 1419097
	5 m	1419093	5 m 1419098
	10 m	1419094	10 m 1419099
	15 m	1419095	15 m 1419100
	20 m	1419096	20 m 1419101

M12 female connector, straight	Order No.	Order No.	Order No.
	0.3 m	1419102	0.3 m 1419110
	0.5 m	1419103	0.5 m 1419111
	1 m	1419104	1 m 1419112
	2 m	1419105	2 m 1419113
	5 m	1419106	5 m 1419114
	10 m	1419107	10 m 1419115
	15 m	1419108	15 m 1419116
	20 m	1419109	20 m 1419117
	0.3 m	1419118	0.3 m 1419126
	0.5 m	1419119	0.5 m 1419127
	1 m	1419120	1 m 1419128
	2 m	1419121	2 m 1419129
	5 m	1419122	5 m 1419130
	10 m	1419123	10 m 1419131
	15 m	1419124	15 m 1419132
	20 m	1419125	20 m 1419133

Color coding	Pin assignment M12
OG	1
n.c.	2
BU	3
Shield	4

Technical data	
M12	
Rated voltage	48 V AC / 60 V DC
Rated current [A]	4
Contact resistance	≤ 5 mΩ
Contact material	CuSn
Contact surface material	Ni/Au
Material of grip body	TPU, hardly inflammable, self-extinguishing
Degree of protection	IP65 / IP67 / IP68 / IP69K
Temperature data	
Male connector/female connector [°C]	-25 ... 90

**Assembled cables,
DeviceNet™/CANopen®,
M12, unshielded**

Notes:
For information about the cable qualities, see page 455
For H, Y, and T distributors, see page 436
For termination resistors, see page 437

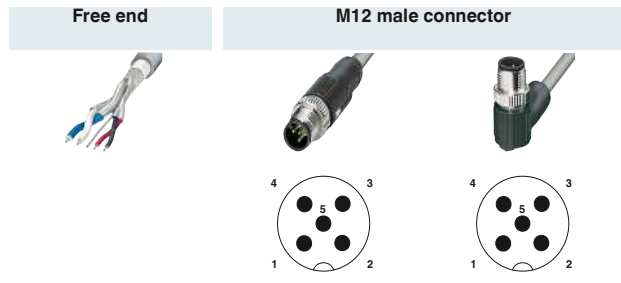

Ordering data

Free end	Order No.	Order No.	Order No.
		2 m	1419039
		5 m	1419040
		10 m	1419041
		15 m	1419042
		20 m	1419043
		0.3 m	1419049
		0.5 m	1419050
		1 m	1419051
		2 m	1419052
		5 m	1419053
		0.3 m	1419065
		0.5 m	1419066
		1 m	1419067
		2 m	1419068
		5 m	1419069

Color coding	Pin assignment
Shield	1
RD	2
BK	3
WH	4
BU	5

Technical data	
M12	
Rated voltage	48 V AC / 60 V DC
Rated current [A]	4
Contact resistance	< 5 mΩ
Contact material	CuSn
Contact surface material	Ni/Au
Material of grip body	TPU
Degree of protection	IP65 / IP67
Temperature data	
Male connector/female connector	[-25 ... 90

Data connectors and cables

Fieldbus components – Assembled cables

Assembled cables, DeviceNet™/CANopen®, M8

Notes:

For information about the cable qualities, see page 455





For termination resistors, see page 437

Free end



M8 male connector



	Ordering data		Ordering data		Ordering data	
Free end	Order No.	Order No.	Order No.	Order No.	Order No.	Order No.
		2 m	1575712			
		5 m	1575725			
		10 m	1575738			
		15 m	1575754			
		Variable	1575767	Variable	1575903	
M8 female connector, straight  		0.3 m	1575822			
		0.5 m	1575835			
		1 m	1575848			
	2 m	1575770	2 m	1575851		
	5 m	1575783	5 m	1575864		
	10 m	1575796	10 m	1575877		
	15 m	1575806	15 m	1575880		
Variable	1575819	Variable	1575893	Variable	1575932	
M8 female connector, angled  						
	Variable	1575916			Variable	1575945

Ordering example for cable with variable cable length:

For a DeviceNet™ bus cable, straight M8 female to straight M8 male and 34.5 m cable length, the ordering data is as follows:

Order No.	Length [m]
	40 m, maximum
1575893	34.5
	Increments:
	0.2 ... 3.0 m = 0.1 m
	> 3.0 m = 0.5 m

Technical data

		M8
Rated voltage		30 V AC / 30 V DC
Rated current	[A]	4
Contact resistance		≤ 5 mΩ
Contact material		CuSn
Contact surface material		Ni/Au
Material of grip body		TPU, hardly inflammable, self-extinguishing
Degree of protection		IP65 / IP67
Temperature data		
Male connector/female connector	[°C]	-25 ... 90

Assembled cables, DeviceNet™/CANopen®, M12

Notes:
 For information about the cable qualities, see page 455
 For H, Y, and T distributors, see page 436
 For termination resistors, see page 437

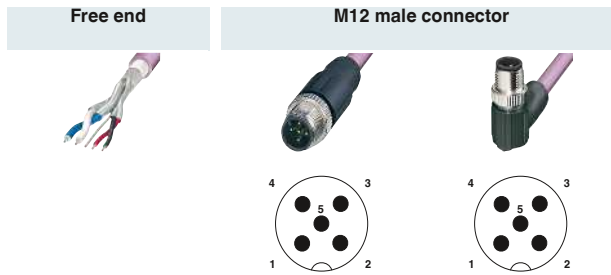

Ordering data

Free end	Order No.	Order No.	Order No.	
		2 m	1507421	
		5 m	1507434	
		10 m	1507447	
		15 m	1507450	
	Variable	1511504	Variable	1538102
M12 female connector, straight 		0.3 m	1507528	
		0.5 m	1507531	
		1 m	1507544	
		2 m	1507557	
		5 m	1507560	
		10 m	1507573	
		15 m	1507586	
Variable	1538128	Variable	1538144	
M12 female connector, angled 				
	Variable	1431092	Variable	1431102
			Variable	1431128

Ordering example for cable with connector assembly:

For a DeviceNet™ bus cable, straight M12 socket to straight M12 pin and 34.5 m cable length, the ordering data is as follows:

Order No.	Length [m]
1538144	34.5
	Increments:
	0.2 ... 3.0 m = 0.1 m
	> 3.0 m = 0.5 m

Ordering example for cable without connector assembly:

For a DeviceNet™ bus cable with 34.5 m cable length, the ordering data is as follows:

Order No.	Length [m]
1511504	34.5
	Increments:
	0.5 ... 400.0 m = 0.5 m

Technical data	
M12	
Rated voltage	48 V AC / 60 V DC
Rated current [A]	4
Contact resistance	≤ 5 mΩ
Contact material	CuSn
Contact surface material	Ni/Au
Material of grip body	TPU, hardly inflammable, self-extinguishing
Degree of protection	IP65 / IP67
Temperature data	
Male connector/female connector [°C]	-25 ... 90

Fieldbus components – Assembled cables

M12 Y distributors, DeviceNet™/CANopen®, unshielded

Notes:
For information about the cable qualities, see page 455
For H, Y, and T distributors, see page 436
For termination resistors, see page 437



Bus system cable



Bus system cable

ERC

Technical data

Electrical data	
Rated voltage	48 V AC / 60 V DC
Rated current	4 A
Contact resistance	≤ 5 mΩ
Material data	
Contact material	CuSn
Contact surface material	Ni/Au
Contact carrier material	TPU GF
Flammability rating in accordance with UL 94	HB
Mechanical data	
Number of positions	5
Degree of pollution	3
Degree of protection	IP65/IP67
External cable diameter	6.70 mm
Conductor cross section for signal	0.2 mm ²
Conductor structure signal line	19x 0.12 mm
Conductor cross section for power	0.32 mm ²
Conductor structure, voltage supply	19x 0.15 mm
Temperature data	
Male connector/female connector	[°C] -25 ... 90
Cable, fixed installation	[°C] -40 ... 80
Cable, flexible installation	[°C] -20 ... 80

ERC

Technical data

Electrical data	
Rated voltage	48 V AC / 60 V DC
Rated current	4 A
Contact resistance	≤ 5 mΩ
Material data	
Contact material	CuSn
Contact surface material	Ni/Au
Contact carrier material	TPU GF
Flammability rating in accordance with UL 94	HB
Mechanical data	
Number of positions	5
Degree of pollution	3
Degree of protection	IP65/IP67
External cable diameter	6.70 mm
Conductor cross section for signal	0.2 mm ²
Conductor structure signal line	19x 0.12 mm
Conductor cross section for power	0.32 mm ²
Conductor structure, voltage supply	19x 0.15 mm
Temperature data	
Male connector/female connector	[°C] -25 ... 90
Cable, fixed installation	[°C] -40 ... 80
Cable, flexible installation	[°C] -20 ... 80

Ordering data

Description	Type	Order No.	Pcs./Pkt.
Bus system Y-cable , 5-pos., shielded, PUR, halogen-free, violet, unshielded straight M12 Y-female to straight M12 female and straight M12 connector			
- Conductor length 0.3 m	SAC-5PY-F/2X 0,3-920-MS-FS	1436013	1
- Conductor length 0.5 m	SAC-5PY-F/2X 0,5-920-MS-FS	1436026	1
- Conductor length 1.0 m	SAC-5PY-F/2X 1,0-920-MS-FS	1436039	1
- Conductor length 2.0 m	SAC-5PY-F/2X 2,0-920-MS-FS	1436042	1
- Conductor length 5.0 m	SAC-5PY-F/2X 5,0-920-MS-FS	1436055	1
- Conductor length 10.0 m	SAC-5PY-F/2X10,0-920-MS-FS	1436068	1
- Conductor length 15.0 m	SAC-5PY-F/2X15,0-920-MS-FS	1436071	1
Bus system Y-cable , 5-pos., shielded, PUR, halogen-free, violet, unshielded straight M12 Y-connector to free cable ends			
- Conductor length 2.0 m			
- Conductor length 5.0 m			
- Conductor length 10.0 m			
- Conductor length 15.0 m			
Bus system Y-cable , 5-pos., shielded, PUR, halogen-free, violet, unshielded straight M12 Y-female to free cable ends			
- Conductor length 2.0 m			
- Conductor length 5.0 m			
- Conductor length 10.0 m			
- Conductor length 15.0 m			

Ordering data

Description	Type	Order No.	Pcs./Pkt.
Bus system Y-cable , 5-pos., shielded, PUR, halogen-free, violet, unshielded straight M12 Y-connector to free cable ends			
- Conductor length 2.0 m	SAC-5PY-M/2X 2,0-920	1436084	1
- Conductor length 5.0 m	SAC-5PY-M/2X 5,0-920	1436097	1
- Conductor length 10.0 m	SAC-5PY-M/2X10,0-920	1436107	1
- Conductor length 15.0 m	SAC-5PY-M/2X15,0-920	1436110	1
Bus system Y-cable , 5-pos., shielded, PUR, halogen-free, violet, unshielded straight M12 Y-female to free cable ends			
- Conductor length 2.0 m	SAC-5PY-F/2X 2,0-920	1436123	1
- Conductor length 5.0 m	SAC-5PY-F/2X 5,0-920	1436136	1
- Conductor length 10.0 m	SAC-5PY-F/2X10,0-920	1436149	1
- Conductor length 15.0 m	SAC-5PY-F/2X15,0-920	1436152	1

Assembled cables, FOUNDATION Fieldbus, M12 stainless steel

Notes:
 For H, Y, and T distributors, see page 436
 For termination resistors, see page 437

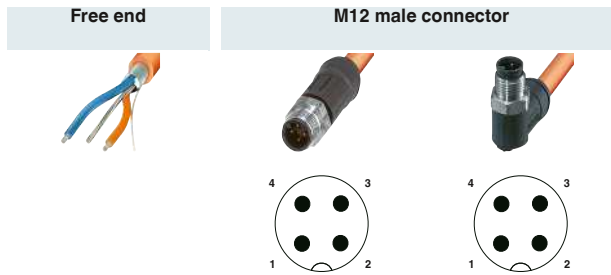

	Ordering data	Ordering data	Ordering data	
Free end	Order No.	Order No.	Order No.	
		2 m	1431173	
		5 m	1431186	
		10 m	1431199	
		15 m	1431209	
	Variable	1432389	Variable	1431322
M12 female connector, straight 	Variable	1431335		
		0.3 m	1431254	
		0.5 m	1431267	
		1 m	1431270	
		2 m	1431283	
		5 m	1431296	
		10 m	1431306	
		15 m	1431319	
	Variable	1431348	Variable	1431364
	Variable	1431377		
M12 female connector, angled 	Variable	1431351	Variable	1431380
	Variable	1431393		
	Variable	1431393		

Ordering example for products with variable cable:

For a 34.5 m long FOUNDATION Fieldbus cable, fitted with a straight M12 male at one end and an M12 female at the other end, the ordering data is as follows:

Order No.	Length [m] max. 50 m
1431364	34.5 Increment: 0.5 m

Color coding	Pin assignment
	M12
BU	1
BN	2
Shield	3
n. c.	4

Technical data	
Connectors	
M12	
Rated voltage	48 V AC / 60 V DC
Rated current	[A] 4
Contact resistance	≤ 5 mΩ
Contact material	CuSn
Contact surface material	Ni/Au
Material of grip body	TPU, hardly inflammable, self-extinguishing
Material, knurls	Stainless steel
Degree of protection	IP65 / IP67 / IP68 / IP69K
Temperature data	
Male connector/female connector	[°C] -25 ... 90

H, Y, and T distributors



H and Y distributors



T-distributor

ERC

Technical data

	H distributor, 5-pos.	Y distributor, hybrid
General data		
Degree of protection	IP65 / IP67	IP67
Electrical data		
Rated voltage	48 V AC / 60 V DC	30 V AC (Power and data) / 30 V DC (Power and data)
Insulation resistance	≥ 100 MΩ	≥ 100 MΩ
Overvoltage category / Degree of pollution	II / 3	III / 3
Material data		
Contact material	CuZn	CuZn
Contact surface material	Ni/Au	Ni/Au
Contact carrier material	TPU GF	-
Material of grip body	TPU, hardly inflammable, self-extinguishing	TPU, hardly inflammable, self-extinguishing
Temperature data		
Male connector/female connector [°C]	-25 ... 90	-25 ... 80

ERC

Technical data

	T distributor, 4-pos.	T distributor, 5-pos.
General data		
Degree of protection	IP65 / IP67 / IP68	IP65 / IP67
Electrical data		
Rated voltage	48 V AC / 60 V DC	48 V AC / 60 V DC
Insulation resistance	≥ 100 MΩ	≥ 100 MΩ
Overvoltage category / Degree of pollution	II / 3	II / 3
Material data		
Contact material	CuZn	CuZn
Contact surface material	Ni/Au	Ni/Au
Contact carrier material	TPU GF	TPU GF
Material of grip body	TPU, hardly inflammable, self-extinguishing	TPU, hardly inflammable, self-extinguishing
Temperature data		
Male connector/female connector [°C]	-25 ... 90	-25 ... 90

Ordering data

Description	Order No.	Pcs./Pkt.	Order No.	Pcs./Pkt.
	H distributor, 5-pos.		Y distributor, hybrid	
Bus system H distributor, for DeviceNet™ with two mounting holes				
M12 male to 3x M12 female	1417414	1		
Hybrid Y distributor, 4+4-pos., for data and power				
M12 connector (Y-coded) to M12 female (D-coded) and M12 connector (A-coded)			1410630	1

Ordering data

Description	Order No.	Pcs./Pkt.	Order No.	Pcs./Pkt.
	T distributor, 4-pos.		T distributor, 5-pos.	
Bus system T distributor, for PROFIBUS, B-coded, shielded 360°				
M12 female to 2x M12 connector			1424711	1
M12 female to M12 male and fixed M12 male			1424713	1

Bus system T distributor, for CANopen® and DeviceNet™, M12 female to M12 female and M12 connector				
Green			1541186	1
black, with two mounting holes			1424712	1
Bus system T distributor, for CC-Link				
M12 female on M12 female and M12 male			1559783	5
Bus system T distributor, for FOUNDATION Fieldbus and PROFIBUS PA (M12), with stainless steel knurl				
M12 female on M12 female and M12 male			1431416	5

Termination resistors



M8 termination resistor



M12 termination resistor



Technical data

	SAC-5P-M 8MS DN TR
Electrical data	
Nominal voltage U_N	30 V
Insulation resistance	-
Overvoltage category / Degree of pollution	II / 3
Material data	
Contact material	CuSn
Contact surface material	Ni/Au
Contact carrier material	TPU GF
Material of grip body	TPU, hardly inflammable, self-extinguishing
Degree of protection	IP65/IP67/IP69K
Temperature data	
Male connector/female connector	-25 ... 90 [°C]

Ordering data

Description	Type	Order No.	Pcs./Pkt.
Termination resistor, M8 male			
- DeviceNet™	SAC-5P-M 8MS DN TR	1435988	5
Termination resistor, M12 male			
- PROFIBUS			
- DeviceNet™/CANopen®			
- CC-Link			
Termination resistor, M12 male, high-grade steel knurl			
- FOUNDATION Fieldbus			



Technical data

	SAC-5P-M12MS PB TR	SAC-4P-M12MS FF TR VA
Electrical data		
Nominal voltage U_N	48 V AC	24 V
Insulation resistance	$\geq 100 \text{ M}\Omega$	$\geq 100 \text{ M}\Omega$
Overvoltage category / Degree of pollution	II / 3	II / 3
Material data		
Contact material	CuSn	CuZn
Contact surface material	Ni/Au	Ni/Au
Contact carrier material	TPU GF	TPU GF
Material of grip body	TPU, hardly inflammable, self-extinguishing	TPU, hardly inflammable, self-extinguishing
Degree of protection	-	IP65/IP68/IP69K
Temperature data		
Male connector/female connector	-25 ... 90	-25 ... 90

Ordering data

Description	Type	Order No.	Pcs./Pkt.
Termination resistor, M12 male			
- PROFIBUS	SAC-5P-M12MS PB TR	1507803	5
- DeviceNet™/CANopen®	SAC-5P-M12MS CAN TR	1507816	5
- CC-Link	SAC-4P-M12MS CCL TR	1558470	1
Termination resistor, M12 male, high-grade steel knurl			
- FOUNDATION Fieldbus	SAC-4P-M12MS FF TR VA	1431403	5

Fieldbus components – AS-Interface

Flat-ribbon conductors, flat-ribbon conductor connectors and panel feed-throughs



Flat-ribbon conductors and accessories



Flat-ribbon conductors and panel feed-throughs with QUICKON fast connection technology



	Technical data	
	VS-ASI-FC-PVC...	VS-ASI-FC-PUR...
Mechanical data		
Number of positions	2	2
Degree of protection	-	-
Cable data		
Outer sheath material	PVC	PUR
Conductor cross section	1.5 mm ²	1.5 mm ²
Connector data QUICKON connection		
Conductor cross section [mm ²]	-	-
Conductor cross section [AWG]	-	-
Temperature data		
Male connector/female connector	[°C]	-
Cable, fixed installation	[°C]	-30 ... 90
Cable, flexible installation	[°C]	-20 ... 90

	Technical data	
	Q 1,5/4IDC	Q 1,5/4M20
Mechanical data		
Number of positions	4	4
Degree of protection	IP65 / IP67	IP65 / IP67
Cable data		
Outer sheath material	-	-
Conductor cross section	-	-
Connector data QUICKON connection		
Conductor cross section [mm ²]	0.75 mm ² ... 1.5 mm ²	0.75 mm ² ... 1.5 mm ²
Conductor cross section [AWG]	18 ... 16	18 ... 16
Temperature data		
Male connector/female connector	-25 ... 80	-25 ... 80
Cable, fixed installation	-	-
Cable, flexible installation	-	-

		Ordering data		
Description	Cable length	Type	Order No.	Pcs./Pkt.
AS-Interface EPDM flat-ribbon conductor, 2 x 1.5 mm²				
yellow	100 m	VS-ASI-FC-EPDM-YE 100M	1432402	1
black	100 m	VS-ASI-FC-EPDM-BK 100M	1432415	1
AS-Interface PVC flat-ribbon conductor to UL, 2 x 1.5 mm²				
yellow	100 m	VS-ASI-FC-PVC-UL-YE 100M	1404906	1
black	100 m	VS-ASI-FC-PVC-UL-BK 100M	1404919	1
AS-Interface TPE flat-ribbon conductor to UL, 2 x 1.5 mm²				
yellow	100 m	VS-ASI-FC-TPE-UL-YE 100M	1404922	1
black	100 m	VS-ASI-FC-TPE-UL-BK 100M	1404935	1
AS-Interface PUR flat-ribbon conductor, 2 x 1.5 mm²				
yellow	100 m	VS-ASI-FC-PUR-YE 100M	1404883	1
black	100 m	VS-ASI-FC-PUR-BK 100M	1404896	1
Flat connector, 4-pos., for connecting one or two AS-i flat-ribbon conductors				
Panel feed-through, for accommodating one or two AS-i flat-ribbon conductors, on the rear side with manual solder/slip-on connection 4.8 x 0.8 mm				
Panel feed-through, for accommodating one or two AS-Interface flat-ribbon conductors, on the rear side with four individual 1.5 mm² wires				
	0.5 m			
Metal gland, for AS-Interface flat-ribbon conductor				
Thread type: M20				
Thread type: M25				

		Ordering data		
Type	Order No.	Pcs./Pkt.		
Q 1,5/4IDC/24-24KU-KU-ASI-BK	1585058	1		
Q 1,5/4FL/24-M20KU-ESA-ASI BK	1437261	1		
Q 1,5/4A50/24-M20KU-ESA-ASI BK	1437274	1		
HC-M-KV-M20(1ASI)	1584017	10		
HC-M-KV-M25(1ASI)	1584020	10		

Distributors with spring connection and with round cables



Flat-ribbon conductor distributor and distributor with spring connection



Distributor with round cable and over-molded M12 connector

ERC

Technical data	
SAC-ASI-J-Y-B-FFKDS	SAC-ASI-J-YY-N
Rated voltage	≤ 32 V DC
Rated current	4 A
Material specifications for exit	
Material of grip body	-
Material specifications for distributor	
Housing material	PBT
Mechanical data	
Number of positions	4
Degree of protection	IP20
Connection data for spring-cage terminal blocks	
Conductor cross section	0.2 mm ² ... 1.5 mm ² (without ferrule)
Connection cross section AWG	24 ... 16 (without ferrule)
Cable data	
Outer sheath material	-
External cable diameter	-
Conductor cross section	-
Temperature data	
Male connector/female connector	[°C] -25 ... 75
Cable, fixed installation	[°C] -
Cable, flexible installation	[°C] -

ERC

Technical data	
SAC-ASI-J-Y-N...	SAC-ASI-J-Y-B...
Rated voltage	≤ 32 V DC
Rated current	4 A
Material specifications for exit	
Material of grip body	-
Material specifications for distributor	
Housing material	PBT
Mechanical data	
Number of positions	2
Degree of protection	IP65 / IP67
Connection data for spring-cage terminal blocks	
Conductor cross section	-
Connection cross section AWG	-
Cable data	
Outer sheath material	PUR
External cable diameter	4.3 mm
Conductor cross section	4x 0.34 mm ² (signal line)
Temperature data	
Male connector/female connector	[°C] -25 ... 75
Cable, fixed installation	[°C] -40 ... 80
Cable, flexible installation	[°C] -25 ... 80

Ordering data			
Description	Cable length	Type	Order No.
AS-Interface distributor with IP20 protection for 2 flat-ribbon conductors , 4-pos., with spring terminal blocks		SAC-ASI-J-Y-B-FFKDS	1407579
AS-Interface H-distributor with high degree of protection, parallel wired , for distribution from one to two flat-ribbon conductors		SAC-ASI-J-YY-N	1405622
AS-Interface distributor for 1 flat cable, with PUR round cable and molded, straight , A-coded, 2-pos. M12 female	1 m 2 m		
AS-Interface distributor for 2 flat cables, with PUR round cable and molded, straight , A-coded, 4-pos. M12 female	1 m 2 m		
AS-Interface distributor for 2 flat cables, with PUR round cable and molded, angled , A-coded, 4-pos. M12 female	1 m 2 m		
AS-Interface distributor for 1 flat-ribbon conductor, with 2.0 m PUR round cable and open cable end	2 m		
AS-Interface distributor for 2 flat-ribbon conductors, with 2.0 m PUR round cable and open cable end	2 m		

Ordering data			
Description	Cable length	Type	Order No.
AS-Interface distributor for 1 flat cable, with PUR round cable and molded, straight , A-coded, 2-pos. M12 female	1 m 2 m	SAC-ASI-J-Y-N-PUR-1,0-FS SCO	1407573
AS-Interface distributor for 2 flat cables, with PUR round cable and molded, straight , A-coded, 4-pos. M12 female	1 m 2 m	SAC-ASI-J-Y-N-PUR-2,0-FS SCO	1407574
AS-Interface distributor for 2 flat cables, with PUR round cable and molded, angled , A-coded, 4-pos. M12 female	1 m 2 m	SAC-ASI-J-Y-B-PUR-1,0-FS SCO	1407575
AS-Interface distributor for 2 flat cables, with PUR round cable and molded, angled , A-coded, 4-pos. M12 female	1 m 2 m	SAC-ASI-J-Y-B-PUR-2,0-FS SCO	1407576
AS-Interface distributor for 1 flat-ribbon conductor, with 2.0 m PUR round cable and open cable end	2 m	SAC-ASI-J-Y-B-PUR-1,0-FR SCO	1407577
AS-Interface distributor for 2 flat-ribbon conductors, with 2.0 m PUR round cable and open cable end	2 m	SAC-ASI-J-Y-B-PUR-2,0-FR SCO	1407578
AS-Interface distributor for 1 flat-ribbon conductor, with 2.0 m PUR round cable and open cable end	2 m	SAC-ASI-J-Y-N-PUR-2,0-OE	1407580
AS-Interface distributor for 2 flat-ribbon conductors, with 2.0 m PUR round cable and open cable end	2 m	SAC-ASI-J-Y-B-PUR-2,0-OE	1407581

Digital I/O devices with M8 connection method

The digital I/O devices are particularly suitable for use in machines close to the process.

Features:

- Optimized for 30 mm mounting profile
- M12 connection technology with fast locking system for the AS-Interface connection
- M8 connection technology for inputs and outputs



4 digital inputs



4 digital inputs and 4 digital outputs

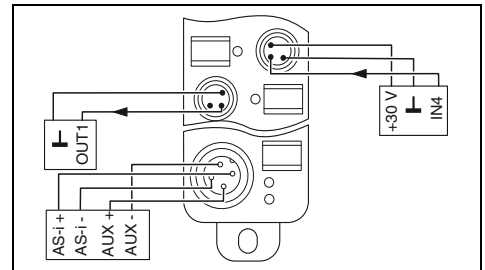
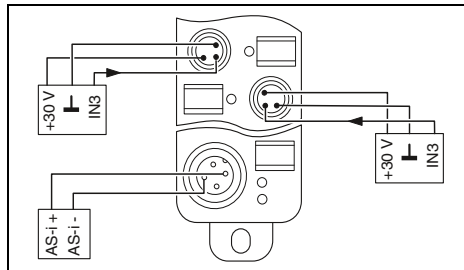

Technical data

Interface	
Fieldbus system	AS-i
Connection method	M12 connector, (A-coded)
AS-Interface	
AS-i specification	2.0
Required master specification	>= 2.0
AS-i profile	S-0.0
Digital inputs	
Connection method	M8 connector
Connection technology	2, 3-wire
Maximum number of inputs	-
Input characteristic curve	-
Digital outputs	
Connection method	-
Connection technology	-
Maximum number of outputs	-
Maximum output current per channel	-
Maximum output current per module / terminal block	-
General data	
Weight	85 g
Drill hole spacing	93 mm
Dimensions	W / H / D 30 mm / 26 mm / 103 mm
Degree of protection	IP65/IP67
Ambient temperature (operation)	-25°C ... 70°C
EMC note	Class A product, see page 727

Technical data

Interface	
Fieldbus system	AS-i
Connection method	M12 connector, (A-coded)
AS-Interface	
AS-i specification	2.0
Required master specification	>= 2.0
AS-i profile	S-7.0
Digital inputs	
Connection method	M8 connector
Connection technology	2, 3-wire
Maximum number of inputs	-
Input characteristic curve	-
Digital outputs	
Connection method	M8 connector
Connection technology	2-wire
Maximum number of outputs	-
Maximum output current per channel	1 A
Maximum output current per module / terminal block	4 A
General data	
Weight	125 g
Drill hole spacing	133 mm
Dimensions	W / H / D 30 mm / 26 mm / 143 mm
Degree of protection	IP65/IP67
Ambient temperature (operation)	-25°C ... 70°C
EMC note	Class A product, see page 727

Ordering data

Description	
Fieldline Extension AS-i digital input device	
- 4 inputs	
Fieldline Extension AS-i digital I/O device	
- 4 inputs, 4 outputs, 1 A	

Type	Order No.	Pcs./Pkt.
FLX ASI DI 4 M8	2773403	1

Ordering data

Type	Order No.	Pcs./Pkt.
FLX ASI DIO 4/4 M8-1A	2773416	1

Accessories

M8 screw plug	PROT-M8	1682540	5
Zack marker strip, flat, 10-section, without color print	ZBF 8:UNBEDRUCKT	0808781	10
Manual addressing device, for AS-Interface devices	ASI CC ADR	2741338	1

M8 screw plug	PROT-M8	1682540	5
Zack marker strip, flat, 10-section, without color print	ZBF 8:UNBEDRUCKT	0808781	10
Manual addressing device, for AS-Interface devices	ASI CC ADR	2741338	1

Accessories

M8 screw plug	PROT-M8	1682540	5
Zack marker strip, flat, 10-section, without color print	ZBF 8:UNBEDRUCKT	0808781	10
Manual addressing device, for AS-Interface devices	ASI CC ADR	2741338	1

Digital I/O devices with M12 connection method

The innovative locking mechanism enables quick and easy installation of the I/O devices.

Features:

- Optimized for direct mounting and DIN rail mounting
- Tool-free connection to AS-Interface, thanks to piercing technology
- M12 connection technology with fast locking system for the inputs and outputs



4 digital inputs



4 digital outputs

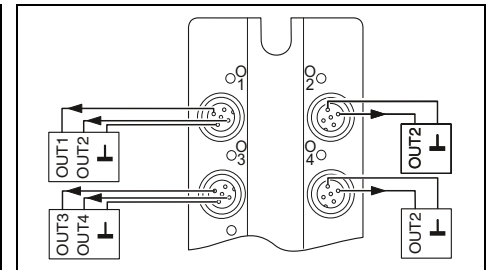
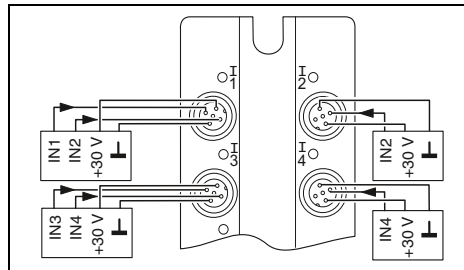

Technical data

Technical data

Interface	
Fieldbus system	AS-i
Connection method	Flat-ribbon cable penetration technique
AS-Interface	
AS-i specification	2.1
Required master specification	>= 2.0
AS-i profile	S-0.A.2
Digital inputs	
Connection method	M12 connector
Connection technology	2, 3-wire
Maximum number of inputs	-
Input characteristic curve	-
Digital outputs	
Connection method	-
Connection technology	-
Maximum number of outputs	-
Maximum output current per channel	-
Maximum output current per module / terminal block	-
General data	
Weight	195 g
Drill hole spacing	108 mm
Dimensions	58 mm / 118 mm / 35 mm
Degree of protection	IP65/IP67
Ambient temperature (operation)	-25°C ... 70°C
EMC note	Class A product, see page 727

Interface	
Fieldbus system	AS-i
Connection method	Flat-ribbon cable penetration technique
AS-Interface	
AS-i specification	2.0
Required master specification	>= 2.0
AS-i profile	S-8.1
Digital inputs	
Connection method	-
Connection technology	-
Maximum number of inputs	-
Input characteristic curve	-
Digital outputs	
Connection method	M12 connector
Connection technology	2-wire
Maximum number of outputs	4
Maximum output current per channel	2 A
Maximum output current per module / terminal block	4 A
General data	
Weight	195 g
Drill hole spacing	108 mm
Dimensions	58 mm / 118 mm / 35 mm
Degree of protection	IP65/IP67
Ambient temperature (operation)	-25°C ... 70°C
EMC note	Class A product, see page 727

Ordering data

Ordering data

Description	Type	Order No.	Pcs./Pkt.
Fieldline Extension AS-i digital input device			
- 4 inputs	FLX ASI DI 4 M12	2773429	1
Fieldline Extension AS-i digital output device			
- 4 outputs, 2 A			
Fieldline Extension AS-i digital I/O device			
- 2 inputs, 2 outputs, 2 A			
- 4 inputs, 3 outputs, 2 A			
- 4 inputs, 4 outputs, 2 A			

Description	Type	Order No.	Pcs./Pkt.
Fieldline Extension AS-i digital input device			
- 4 inputs	FLX ASI DI 4 M12	2773429	1
Fieldline Extension AS-i digital output device			
- 4 outputs, 2 A	FLX ASI DO 4 M12-2A	2773458	1
Fieldline Extension AS-i digital I/O device			
- 2 inputs, 2 outputs, 2 A			
- 4 inputs, 3 outputs, 2 A			
- 4 inputs, 4 outputs, 2 A			

Accessories

Accessories

M12 screw plug	PROT-M12	1680539	5
Label sheet for laser printers, 64 x 16 mm, color: white	BMKL 64X16 WH	0821807	2
Manual addressing device , for AS-Interface devices	ASI CC ADR	2741338	1
Programming cable , for addressing the AS-i devices	ASI CC ADR CAB CINCH	2741341	1

M12 screw plug	PROT-M12	1680539	5
Label sheet for laser printers, 64 x 16 mm, color: white	BMKL 64X16 WH	0821807	2
Manual addressing device , for AS-Interface devices	ASI CC ADR	2741338	1
Programming cable , for addressing the AS-i devices	ASI CC ADR CAB CINCH	2741341	1



2 digital inputs
and 2 digital outputs



4 digital inputs
and 3 digital outputs



4 digital inputs
and 4 digital outputs

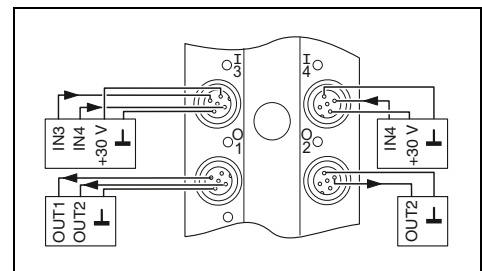
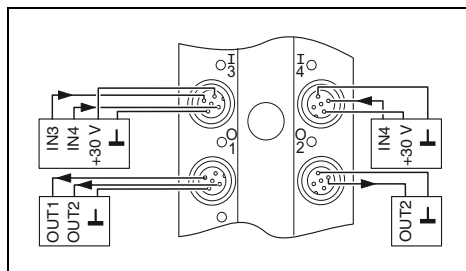
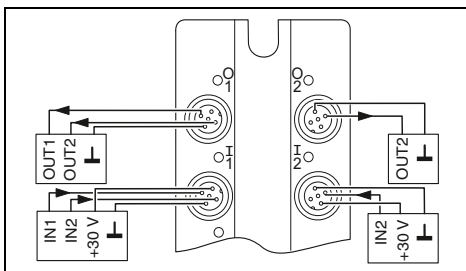

Technical data

AS-i
Flat-ribbon cable penetration technique

2.1
≥ 2.0
S-B.A.2

M12 connector
2, 3-wire

M12 connector
2-wire

2 A
4 A

195 g
108 mm
58 mm / 118 mm / 35 mm
IP65/IP67
-25°C ... 70°C
Class A product, see page 727

Technical data

AS-i
Flat-ribbon cable penetration technique

2.1
≥ 2.0
S-7.A.2

M12 connector
2, 3-wire

M12 connector
2-wire

2 A
4 A

245 g
108 mm
58 mm / 150 mm / 35 mm
IP65/IP67
-25°C ... 70°C
Class A product, see page 727

Technical data

AS-i
Flat-ribbon cable penetration technique

3.0
≥ 3.0
S-7.A.7

M12 connector
2, 3-wire

M12 connector
2-wire

2 A
4 A

245 g
108 mm
58 mm / 150 mm / 35 mm
IP65/IP67
-25°C ... 70°C
Class A product, see page 727

Ordering data

Type	Order No.	Pcs./Pkt.
FLX ASI DIO 2/2 M12-2A	2773432	1

Ordering data

Type	Order No.	Pcs./Pkt.
FLX ASI DIO 4/3 M12-2A	2773445	1

Ordering data

Type	Order No.	Pcs./Pkt.
FLX ASI 3.0 DIO 4/4 M12-2A	2773474	1

Accessories

PROT-M12	1680539	5
BMKL 64X16 WH	0821807	2
ASI CC ADR	2741338	1
ASI CC ADR CAB CINCH	2741341	1

Accessories

PROT-M12	1680539	5
ASI CC ADR	2741338	1
ASI CC ADR CAB CINCH	2741341	1

Accessories

PROT-M12	1680539	5
ASI CC ADR	2741338	1
ASI CC ADR CAB CINCH	2741341	1

D-SUB connectors, IP67



D-SUB complete connector for INTERBUS in IP67 protection



D-SUB connector set IP67, consisting of: sleeve housing, panel mounting frame and accessories, shielded design

ERC

Technical data

Electrical data	
Rated voltage	63 V
Rated current	1 A
Overvoltage category	II
Material data	
Housing material	PA
Contact material	Copper alloy
Contact surface material	Gold over nickel
Contact carrier material	PBTP
Flammability rating in accordance with UL 94	V0
Mechanical data	
Number of positions	9
Color	gray
Degree of pollution	2
Degree of protection	IP67
Connection method	Screw connection
Conductor cross section	0.14 mm ² ... 0.5 mm ²
Connection cross section AWG	26 ... 20
Insertion/withdrawal cycles	≥ 200
Temperature data	
Ambient temperature (operation)	-20°C ... 70°C

ERC

Technical data

Electrical data	
Rated voltage	-
Rated current	-
Overvoltage category	-
Material data	
Housing material	PA
Contact material	-
Contact surface material	-
Contact carrier material	-
Flammability rating in accordance with UL 94	V0
Mechanical data	
Number of positions	9
Color	gray
Degree of pollution	2
Degree of protection	IP67
Connection method	-
Conductor cross section	-
Connection cross section AWG	-
Insertion/withdrawal cycles	≥ 1000
Temperature data	
Ambient temperature (operation)	-40°C ... 80°C

Ordering data

Description	
D-SUB complete connector , for INTERBUS, shell size 1, screw connection, shielded	
Male	VS-09-IBS-ST
Female	VS-09-IBS-BU
D-SUB complete connector , for PROFIBUS, shell size 1, male, shielded	
Screw connection	VS-09-PROFIBUS-SC
Spring-cage connection	VS-09-PROFIBUS-SP
D-SUB complete connector , for CANopen®, shell size 1, female, screw connection, shielded	
Female	VS-09-CAN
D-SUB panel mounting frame , for taking up D-SUB contact inserts	
D-SUB 09	
D-SUB EMC shroud , for the IP67 panel mounting frame, for shield contacting to the housing panel	
D-SUB 09	
D-SUB connector set	
D-SUB 09	

Type	Order No.	Pcs./Pkt.
VS-09-IBS-ST	1689271	1
VS-09-IBS-BU	1689284	1
VS-09-PROFIBUS-SC	1654549	1
VS-09-PROFIBUS-SP	1654345	1
VS-09-CAN	1689307	1

Ordering data

Type	Order No.	Pcs./Pkt.
VS-09-A	1688366	5
VS-09-A-EMV-S	1688463	5
VS-09-SET-EMV	1689158	1

**D-SUB connectors,
IP20/IP67**



Screw connection
Fixing: 2.5 mm hole



**D-SUB panel mounting frame IP67,
with integrated gender changer**

ERC

Technical data

Electrical data	
Rated voltage	60 V
Rated current	5 A
Overvoltage category	III
Material data	
Housing material	Steel
Contact material	Cu
Contact surface material	Au/Ni
Contact carrier material	PBTP
Flammability rating in accordance with UL 94	V0
Mechanical data	
Number of positions	9
Color	-
Degree of pollution	2
Degree of protection	IP20
Connection method	Screw connection
Conductor cross section	0.14 mm ² ... 0.5 mm ²
Connection cross section AWG	26 ... 20
Insertion/withdrawal cycles	≥ 200
Temperature data	
Ambient temperature (operation)	-20°C ... 80°C

ERC

Technical data

125 V	125 V
5 A	5 A
III	III
Material data	
PA	PA
Copper alloy	Copper alloy
Hard gold-plated over nickel	Hard gold-plated over nickel
Polyester GF	Polyester GF
V0	V0
Mechanical data	
9	9
gray	gray
2	2
IP67	IP67
-	-
-	-
-	-
≥ 200	≥ 200
Temperature data	
-40°C ... 80°C	-40°C ... 80°C

Ordering data

Description			
D-SUB contact insert			
Male	VS-09-ST-DSUB/10-MPT-0,5	1688379	10
Female	VS-09-BU-DSUB/9-MPT-0,5	1688395	10
D-SUB panel mounting frame, with integrated gender changer, shielded			
D-SUB 09, male/male			
D-SUB 09, female/female			
D-SUB coupling, with integrated gender changer, shielded			
D-SUB 09, male/male			
D-SUB 09, female/female			

Ordering data

Description			
D-SUB panel mounting frame, with integrated gender changer, shielded			
D-SUB 09, male/male	VS-09-A-GC-ST/ST	1689705	5
D-SUB 09, female/female	VS-09-A-GC-BU/BU	1689695	5
D-SUB coupling, with integrated gender changer, shielded			
D-SUB 09, male/male	VS-09-KU-ST/ST	1689640	5
D-SUB 09, female/female	VS-09-KU-BU/BU	1689637	5

D-SUB-based connectors

Signal contacts



Contacts for standard D-SUB contact carriers



Contacts for high density D-SUB contact carriers

ERC

Technical data

	AWG 28 ... 26	AWG 24 ... 20
Electrical data		
Rated voltage	-	-
Rated current	5 A (at 20°C)	5 A (at 20°C)
Contact material	Copper alloy	Copper alloy
Contact surface material	0.2 µm, gold over nickel	0.2 µm, gold over nickel
Mechanical data		
Connection method	Crimp connection	Crimp connection
Conductor cross section	0.08 mm ² ... 0.12 mm ²	0.2 mm ² ... 0.5 mm ²
Connection cross section AWG	28 ... 26	24 ... 20
Insertion/withdrawal cycles	≥ 200	≥ 200
Temperature data		
Ambient temperature (operation)	-55°C ... 130°C	-55°C ... 130°C

Ordering data

Description	Type	Order No.	Pcs./Pkt.
Turned male crimp contacts , for D-SUB contact inserts with standard contact density, gold-plated surface			
AWG 28 ... 26	CUC-DSC-C1BAU-S/DSC28	1418784	100
AWG 24 ... 20	CUC-DSC-C1BAU-S/DSC24	1418786	100
Turned female crimp contacts , for D-SUB contact inserts with standard contact density, gold-plated surface			
AWG 28 ... 26	CUC-DSC-J1BAU-S/DSC28	1418787	100
AWG 24 ... 20	CUC-DSC-J1BAU-S/DSC24	1418788	100
Turned crimp contacts , for D-SUB contact inserts with high density, gold-plated surface			
AWG 28 ... 22, male			
AWG 28 ... 22, female			

ERC

Technical data

	CUC-DSC...BAU-S/DSC22
Electrical data	
Rated voltage	-
Rated current	3 A
Contact material	Copper alloy
Contact surface material	0.2 µm, gold over nickel
Mechanical data	
Connection method	Crimp connection
Conductor cross section	0.08 mm ² ... 0.34 mm ²
Connection cross section AWG	28 ... 22
Insertion/withdrawal cycles	≥ 200
Temperature data	
Ambient temperature (operation)	-55°C ... 115°C

Ordering data

Description	Type	Order No.	Pcs./Pkt.
Turned crimp contacts , for D-SUB contact inserts with high density, gold-plated surface			
AWG 28 ... 22, male	CUC-DSC-C1BAU-S/DSC22	1418789	100
AWG 28 ... 22, female	CUC-DSC-J1BAU-S/DSC22	1418790	100

Accessories

Description	Type	Order No.	Pcs./Pkt.
Crimping pliers , for turned contacts, universal cross section setting, up to a maximum of 2.5 mm ² , digital display with 0.01 mm increments, unlockable pressure lock, lateral entry, including positioning tool			
for turned contacts, four-mandrel crimping	CRIMPFOX-TC MP	1212510	1
Insertion/Extraction Tool , for fitting and removing the D-SUB standard signal contacts			
	VS-IET-DSUB-SIGNAL-STD	1658794	1
Insertion/Extraction Tool , for fitting and removing the D-SUB High Density signal contacts			

Accessories

Description	Type	Order No.	Pcs./Pkt.
Crimping pliers , for turned contacts, universal cross section setting, up to a maximum of 2.5 mm ² , digital display with 0.01 mm increments, unlockable pressure lock, lateral entry, including positioning tool			
for turned contacts, four-mandrel crimping	CRIMPFOX RC 2,5	1205448	1
Insertion/Extraction Tool , for fitting and removing the D-SUB High Density signal contacts			
	VS-IET-DSUB-SIGNAL-HD	1658503	1

Power contacts



With straight solder cups or angled solder pins

With screw connection

ERC

ERC

Technical data	
VS.../2,6	VS-.../4,6
Electrical data	
Rated voltage	-
Rated current	20 A (at 20°C) 40 A (at 20°C)
Material data	
Contact material	Copper alloy Copper alloy
Contact surface material	Au/Sn Au/Sn
Mechanical data	
Connection method	Solder cup Solder cup
Conductor cross section	2 mm ² ... 3.5 mm ² 5 mm ² ... 8.5 mm ²
Connection cross section AWG	14 ... 12 10 ... 8
Insertion/withdrawal cycles	≥ 500 ≥ 500
Temperature data	
Ambient temperature (operation)	-55°C ... 130°C -55°C ... 130°C

Technical data	
VS-...SC-2,6	
Electrical data	
Rated voltage	-
Rated current	20 A
Material data	
Contact material	Copper alloy
Contact surface material	Hard gold-plated over nickel
Mechanical data	
Connection method	Screw connection
Conductor cross section	0.75 mm ² ... 2 mm ²
Connection cross section AWG	18 ... 14
Insertion/withdrawal cycles	≥ 500
Temperature data	
Ambient temperature (operation)	-55°C ... 155°C

Ordering data				
Description	Type	Order No.	Pcs./Pkt.	
Power contact , for D-SUB combination inserts, with straight solder cup, gold-plated surface	Up to 20 A, male	VS-ST-LK-3,6/22,4/2,6	1688243	100
	Up to 40 A, male	VS-ST-LK-3,6/22,4/4,6	1688269	100
	Up to 20 A, female	VS-BU-LK-3,6/22,8/2,6	1688256	100
	Up to 40 A, female	VS-BU-LK-3,6/22,8/4,6	1688272	100
	Power contact , for D-SUB combination inserts, with straight solder pin, gold-plated surface	Up to 20 A, male	CUC-DSC-J1MAU-S/DLSL:100	1426074
Up to 20 A, female		CUC-DSC-C1MAU-S/DLSL:100	1426073	100
Power contact , for D-SUB combination inserts, with angled solder pins for PCB mounting, gold-plated surface	Up to 40 A, male	VS-ST-LH-3,6/18/3,8	1655467	100
	Up to 40 A, female	VS-BU-LH-3,6/18/3,8	1655454	100
Power contact , for D-SUB combination inserts, with straight screw connection, gold-plated surface	Up to 40 A, male			
	Up to 40 A, female			

Ordering data				
Description	Type	Order No.	Pcs./Pkt.	
Power contact , for D-SUB combination inserts, with straight screw connection, gold-plated surface	Up to 40 A, male	VS-ST-SC-2,6	1655483	30
	Up to 40 A, female	VS-BU-SC-2,6	1655470	30



Accessories			
Removal tool	HC-M4-KOAX-EWZ	1676747	1

Accessories			
Removal tool	HC-M4-KOAX-EWZ	1676747	1



Data connectors and cables

D-SUB-based connectors

Sleeve housings and contact inserts with IP20 degree of protection

Signal		
Solder connection		
		
Solder cups		
VS-...-ST-DSUB-EG VS-...-BU-DSUB-EG	VS-...-ST-DSUB-HD-EG VS-...-BU-DSUB-HD-EG	
D-SUB contact insert Fixing: 3 mm drill hole	D-SUB contact insert, high-position Fixing: 3 mm drill hole	







Type	Order No.	Number of positions	Male	Female	Number of positions	Male	Female		
IP20, all metal		CUC-DST-GZNI-S/DSSC9	1419722	9	1688793	1688803	15	1655111	1655108
		CUC-DST-GZNI-S/DSSC15	1419724	15	1688874	1688887	26	1655179	1655166
		CUC-DST-GZNI-S/DSSC25	1419727	25	1689899	1689909	44	1655234	1655221
		CUC-DST-GZNI-S/DSSC25	1419727						
		CUC-DST-GZNI-S/DSSC15	1419724						
		CUC-DST-GZNI-S/DSSC25	1419727						
		CUC-DST-GZNI-A/DSSC9	1419723	9	1688793	1688803	15	1655111	1655108
		CUC-DST-GZNI-A/DSSC15	1419725	15	1688874	1688887	26	1655179	1655166
		CUC-DST-GZNI-A/DSSC25	1419728	25	1689899	1689909	44	1655234	1655221
		CUC-DST-GZNI-A/DSSC25	1419728						
		CUC-DST-GZNI-A/DSSC15	1419725						
		CUC-DST-GZNI-A/DSSC25	1419728						
		CUC-DST-GZNI-S/DSFL9	1419746	9	1688793	1688803	15	1655111	1655108
		CUC-DST-GZNI-S/DSFL15	1419756	15	1688874	1688887	26	1655179	1655166
		CUC-DST-GZNI-S/DSFL25	1419758	25	1689899	1689909	44	1655234	1655221
		CUC-DST-GZNI-S/DSFL25	1419758						
		CUC-DST-GZNI-S/DSFL15	1419756						
		CUC-DST-GZNI-S/DSFL25	1419758						
		CUC-DST-GZNI-A/DSFL9	1419754	9	1688793	1688803	15	1655111	1655108
		CUC-DST-GZNI-A/DSFL15	1419757	15	1688874	1688887	26	1655179	1655166
		CUC-DST-GZNI-A/DSFL25	1419759	25	1689899	1689909	44	1655234	1655221
		CUC-DST-GZNI-A/DSFL25	1419759						
		CUC-DST-GZNI-A/DSFL15	1419757						
		CUC-DST-GZNI-A/DSFL25	1419759						
IP20, metal-plated		CUC-DST-GPME-S/DSSC9	1419705	9	1688793	1688803	15	1655111	1655108
		CUC-DST-GPME-S/DSSC15	1419710	15	1688874	1688887	26	1655179	1655166
		CUC-DST-GPME-S/DSSC25	1419719	25	1689899	1689909	44	1655234	1655221
		CUC-DST-GPME-S/DSSC25	1419719						
		CUC-DST-GPME-S/DSSC15	1419710						
		CUC-DST-GPME-S/DSSC25	1419719						
		CUC-DST-GPME-A/DSSC9	1419706	9	1688793	1688803	15	1655111	1655108
		CUC-DST-GPME-A/DSSC15	1419718	15	1688874	1688887	26	1655179	1655166
		CUC-DST-GPME-A/DSSC25	1419721	25	1689899	1689909	44	1655234	1655221
		CUC-DST-GPME-A/DSSC25	1419721						
		CUC-DST-GPME-A/DSSC15	1419718						
		CUC-DST-GPME-A/DSSC25	1419721						
		CUC-DST-GPME-S/DSFL9	1419729	9	1688793	1688803	15	1655111	1655108
		CUC-DST-GPME-S/DSFL15	1419731	15	1688874	1688887	26	1655179	1655166
		CUC-DST-GPME-S/DSFL25	1419736	25	1689899	1689909	44	1655234	1655221
		CUC-DST-GPME-S/DSFL25	1419736						
		CUC-DST-GPME-S/DSFL15	1419731						
		CUC-DST-GPME-S/DSFL25	1419736						
		-	-	-	-	-	-	-	-
		CUC-DST-GPME-A/DSFL15	1419757	15	1688874	1688887	26	1655179	1655166
		CUC-DST-GPME-A/DSFL25	1419741	25	1689899	1689909	44	1655234	1655221
		CUC-DST-GPME-A/DSFL25	1419741						
		CUC-DST-GPME-A/DSFL15	1419757						
		CUC-DST-GPME-A/DSFL25	1419741						

Signal						Hybrid			Power							
Crimp connection						Solder connection									Screw connection	
																
Contact carriers for crimp contacts						Solder cups									AWG 28 ... 16	
VS-...-ST-DSUB-CD-... VS-...-BU-DSUB-CD-...			VS-...-ST-DSUB-HD-CD-B VS-...-BU-DSUB-HD-CD-B			VS-...-ST-DSUB-...P-...S VS-...-BU-DSUB-...P-...S			VS-...-ST-DSUB-...P VS-...-BU-DSUB-...P			PSC 1,5/...-F				
D-SUB contact carrier Fixing: 3 mm drill hole			D-SUB contact carrier, high-position Fixing: 3 mm drill hole			D-SUB contact insert Fixing: 3 mm drill hole			D-SUB contact carrier Fixing: 3 mm drill hole			D-SUB contact insert Fixing: 3 mm drill hole				
Number of positions	Male	Female	Number of positions	Male	Female	Number of positions	Male	Female	Number of positions	Male	Female	Number of positions	Female			
9	1688858	1688861	15	1655137	1655124	1PK-4S	1689006	1689019	2PK	1688418	1688421	3	1841909			
15	1688939	1688942	26	1655195	1655182	2PK-5S	1688227	1688230	3PK	1688201	1688214	5	1841912			
25	1689954	1689967	44	1655250	1655247	3PK-10S	1689996	1690008	5PK	1689970	1689983					
						4PK-5S	1655386	1655373								
						1PK-10S	1418755	1418759								
						2PK-15S	1418757	1418760								
						1PK-20S	1418758	1418761								
9	1688858	1688861	15	1655137	1655124	1PK-4S	1689006	1689019	2PK	1688418	1688421	3	1841909			
15	1688939	1688942	26	1655195	1655182	2PK-5S	1688227	1688230	3PK	1688201	1688214	5	1841912			
25	1689954	1689967	44	1655250	1655247	3PK-10S	1689996	1690008	5PK	1689970	1689983					
						4PK-5S	1655386	1655373								
						1PK-10S	1418755	1418759								
						2PK-15S	1418757	1418760								
						1PK-20S	1418758	1418761								
9	1688858	1688861	15	1655137	1655124	1PK-4S	1689006	1689019	2PK	1688418	1688421	3	1841909			
15	1688939	1688942	26	1655195	1655182	2PK-5S	1688227	1688230	3PK	1688201	1688214	5	1841912			
25	1689954	1689967	44	1655250	1655247	3PK-10S	1689996	1690008	5PK	1689970	1689983					
						4PK-5S	1655386	1655373								
						1PK-10S	1418755	1418759								
						2PK-15S	1418757	1418760								
						1PK-20S	1418758	1418761								
9	1688858	1688861	15	1655137	1655124	1PK-4S	1689006	1689019	2PK	1688418	1688421	3	1841909			
15	1688939	1688942	26	1655195	1655182	2PK-5S	1688227	1688230	3PK	1688201	1688214	5	1841912			
25	1689954	1689967	44	1655250	1655247	3PK-10S	1689996	1690008	5PK	1689970	1689983					
						4PK-5S	1655386	1655373								
						1PK-10S	1418755	1418759								
						2PK-15S	1418757	1418760								
						1PK-20S	1418758	1418761								
9	1688858	1688861	15	1655137	1655124	1PK-4S	1689006	1689019	2PK	1688418	1688421	3	1841909			
15	1688939	1688942	26	1655195	1655182	2PK-5S	1688227	1688230	3PK	1688201	1688214	5	1841912			
25	1689954	1689967	44	1655250	1655247	3PK-10S	1689996	1690008	5PK	1689970	1689983					
						4PK-5S	1655386	1655373								
						1PK-10S	1418755	1418759								
						2PK-15S	1418757	1418760								
						1PK-20S	1418758	1418761								
-	-	-	-	-	-	-	-	-	-	-	-	-	-			
15	1688939	1688942	26	1655195	1655182	2PK-5S	1688227	1688230	3PK	1688201	1688214	5	1841912			
25	1689954	1689967	44	1655250	1655247	3PK-10S	1689996	1690008	5PK	1689970	1689983					
						4PK-5S	1655386	1655373								
						1PK-10S	1418755	1418759								
						2PK-15S	1418757	1418760								
						1PK-20S	1418758	1418761								

Data connectors and cables

D-SUB-based connectors

Panel mounting frames, sleeve housings, and contact inserts with IP67 degree of protection

Housing size 1 to 3				Signal								
				Screw connection			Solder connection					
												
				AWG 26 ... 20			Solder cups					
				VS-...-ST-DSUB/...-MPT-0,5 VS-...-BU-DSUB/...-MPT-0,5			VS-...-ST-DSUB-EG VS-...-BU-DSUB-EG			VS-...-ST-DSUB-HD-EG VS-...-BU-DSUB-HD-EG		
				D-SUB contact insert Fixing: 2.5 mm drill hole			D-SUB contact insert Fixing: 3 mm drill hole			D-SUB contact insert, high-position Fixing: 3 mm drill hole		
Type	Order No.		Number of positions	Male	Female	Number of positions	Male	Female	Number of positions	Male	Female	
	IP67 panel mounting frame											
	VS-09-A	1688366		9	1688379	1688395	9	1688793	1688803	15	1655111	1655108
	VS-15-A	1688036		15	1688078	1688094	15	1688874	1688887	26	1655179	1655166
	VS-25-A	1689750		25	1689789	1689776	25	1689899	1689909	44	1655234	1655221
	VS-25-A	1689750										
	VS-15-A	1688036										
	VS-25-A	1689750										
	IP67 sleeve housing											
	VS-09-T-2M16	1688353		9	1688379	1688395	9	1688793	1688803	15	1655111	1655108
	VS-15-T-2PG11	1688052		15	1688078	1688094	15	1688874	1688887	26	1655179	1655166
	VS-25-T-2M20	1689792		25	1689789	1689776	25	1689899	1689909	44	1655234	1655221
	VS-25-T-2M20	1689792										
	VS-15-T-2PG11	1688052										
	VS-25-T-2M20	1689792										
	VS-09-SET-STD	1689145	Panel mounting frame	9	1688379	1688395	9	1688793	1688803	15	1655111	1655108
			Sleeve housing	9	1688379	1688395	9	1688793	1688803	15	1655111	1655108
	VS-15-SET-STD	1689129	Panel mounting frame	15	1688078	1688094	15	1688874	1688887	26	1655179	1655166
			Sleeve housing	15	1688078	1688094	15	1688874	1688887	26	1655179	1655166
	VS-25-SET-STD	1652198	Panel mounting frame	25	1689789	1689776	25	1689899	1689909	44	1655234	1655221
			Sleeve housing	25	1689789	1689776	25	1689899	1689909	44	1655234	1655221
	VS-25-SET-STD	1652198	Panel mounting frame									
			Sleeve housing									
	VS-15-SET-STD	1689129	Panel mounting frame									
			Sleeve housing									
	VS-25-SET-STD	1652198	Panel mounting frame									
			Sleeve housing									
	VS-25-SET-STD	1652198	Panel mounting frame									
			Sleeve housing									
	VS-09-SET-EMV	1689158	Panel mounting frame	9	1688379	1688395	9	1688793	1688803	15	1655111	1655108
			Sleeve housing	9	1688379	1688395	9	1688793	1688803	15	1655111	1655108
	VS-15-SET-EMV	1689132	Panel mounting frame	15	1688078	1688094	15	1688874	1688887	26	1655179	1655166
			Sleeve housing	15	1688078	1688094	15	1688874	1688887	26	1655179	1655166
	VS-25-SET-EMV	1652208	Panel mounting frame	25	1689789	1689776	25	1689899	1689909	44	1655234	1655221
			Sleeve housing	25	1689789	1689776	25	1689899	1689909	44	1655234	1655221
	VS-25-SET-EMV	1652208	Panel mounting frame									
			Sleeve housing									
	VS-15-SET-EMV	1689132	Panel mounting frame									
			Sleeve housing									
	VS-25-SET-EMV	1652208	Panel mounting frame									
			Sleeve housing									
	VS-25-SET-EMV	1652208	Panel mounting frame									
			Sleeve housing									

Note:
Do not use the EMC inner sleeve of the IP67 sleeve housing on the panel mounting side.

Signal						Hybrid			Power							
Solder connection			Crimp connection						Solder connection						Screw connection	
Angled solder pins			Contact carriers for crimp contacts						Solder cups						AWG 28 ... 16	
VS-...-ST-DSUB-LH-B VS-...-BU-DSUB-LH-B			VS-...-ST-DSUB-CD-... VS-...-BU-DSUB-CD-...			VS-...-ST-DSUB-HD-CD-B VS-...-BU-DSUB-HD-CD-B			VS-...-ST-DSUB-...P-...S VS-...-BU-DSUB-...P-...S			VS-...-ST-DSUB-...P VS-...-BU-DSUB-...P			PSC 1,5/...-F	
D-SUB contact insert Fixing: 2.5 mm drill hole and solder plate			D-SUB contact carrier Fixing: 3 mm drill hole			D-SUB contact carrier, high-position Fixing: 3 mm drill hole			D-SUB contact insert Fixing: 3 mm drill hole			D-SUB contact carrier Fixing: 3 mm drill hole			D-SUB contact insert Fixing: 3 mm drill hole	
Number of positions	Male	Female	Number of positions	Male	Female	Number of positions	Male	Female	Number of positions	Male	Female	Number of positions	Male	Female	Number of positions	Female
9	1654785	1654798	9	1688858	1688861	15	1655137	1655124	1PK-4S	1689006	1689019	2PK	1688418	1688421		
15	1654808	1654811	15	1688939	1688942	26	1655195	1655182	2PK-5S	1688227	1688230	3PK	1688201	1688214		
25	1654824	1654837	25	1689954	1689967	44	1655250	1655247	3PK-10S	1689996	1690008	5PK	1689970	1689983		
									4PK-5S	1655386	1655373					
									1PK-10S	1418755	1418759					
									2PK-15S	1418757	1418760					
									1PK-20S	1418758	1418761					
9	1654785	1654798	9	1688858	1688861	15	1655137	1655124	1PK-4S	1689006	1689019	2PK	1688418	1688421	3	1841909
15	1654808	1654811	15	1688939	1688942	26	1655195	1655182	2PK-5S	1688227	1688230	3PK	1688201	1688214	5	1841912
25	1654824	1654837	25	1689954	1689967	44	1655250	1655247	3PK-10S	1689996	1690008	5PK	1689970	1689983		
									4PK-5S	1655386	1655373					
									4PK-5S	1655386	1655373					
									1PK-10S	1418755	1418759					
									1PK-10S	1418755	1418759					
									2PK-15S	1418757	1418760					
									2PK-15S	1418757	1418760					
									1PK-20S	1418758	1418761					
									1PK-20S	1418758	1418761					
9	1654785	1654798	9	1688858	1688861	15	1655137	1655124	1PK-4S	1689006	1689019	2PK	1688418	1688421		
9	1654785	1654798	9	1688858	1688861	15	1655137	1655124							3	1841909
15	1654808	1654811	15	1688939	1688942	26	1655195	1655182	2PK-5S	1688227	1688230	3PK	1688201	1688214		
15	1654808	1654811	15	1688939	1688942	26	1655195	1655182							5	1841912
25	1654824	1654837	25	1689954	1689967	44	1655250	1655247	3PK-10S	1689996	1690008	5PK	1689970	1689983		
25	1654824	1654837	25	1689954	1689967	44	1655250	1655247								
									4PK-5S	1655386	1655373					
									4PK-5S	1655386	1655373					
									1PK-10S	1418755	1418759					
									1PK-10S	1418755	1418759					
									2PK-15S	1418757	1418760					
									2PK-15S	1418757	1418760					
									1PK-20S	1418758	1418761					
									1PK-20S	1418758	1418761					

Data connectors and cables

USB connectors

Assembled cables, IP20/IP67

USB type A plug, IP20



USB type A plug, IP67



Free end	Ordering data		Ordering data		Ordering data	
		Order No.		Order No.		Order No.
	1.00 m	1655771	1.00 m	1655742		
	2.00 m	1655784	2.00 m	1655755		
	5.00 m	1655797	5.00 m	1655768		
USB type B plug, IP20 	1.00 m	1654853	2.00 m	1653896		
	2.00 m	1653935	5.00 m	1653906		
	5.00 m	1653948				
USB type B plug, IP67 	2.00 m	1653919	2.00 m	1653870		
	5.00 m	1653922	5.00 m	1653883		
M12 Mini USB, SPEEDCON 	1 m	1420168				
	2 m	1420171				
	5 m	1420184				

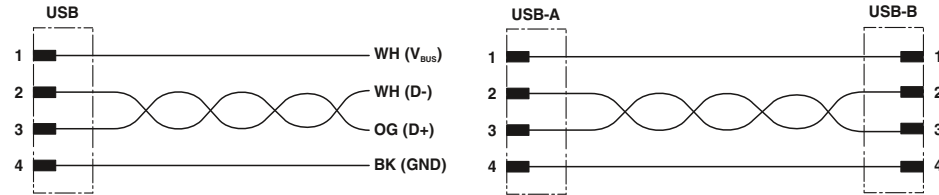

USB cable with free end

USB connector pin assignment

	Technical data	
	IP20	IP67
Transmission characteristics (category)	USB 2.0	USB 2.0
Cable diameter [mm]	6.7	6.7
Housing material	PA	PA
Handle color	black	gray
Number of positions	4	4
Degree of protection	IP20	IP67
Temperature data		
Cable, fixed installation [°C]	-20 ... 60	-20 ... 60
Cable, flexible installation [°C]	0 ... 50	0 ... 50

Panel feed-throughs, memory sticks, protective cover

Panel feed-throughs are implemented with the IP67 panel mounting frame and USB female inserts. The USB memory sticks with IP67 protection enable wireless data transmission in harsh industrial environments.



USB panel mounting frame

ERC

Technical data

VS-04-BUA-BUB-F/IP67

Electrical data	
Rated voltage	30 V
Transmission speed	480 Mbps
Material data	
Housing material	PC
Flammability rating in accordance with UL 94	V0
Mechanical data	
Number of positions	4
Degree of protection	IP67
Insertion/withdrawal cycles	≥ 1000
Temperature data	
Ambient temperature (operation)	-15°C ... 65°C

Ordering data

Description	Type	Order No.	Pcs./Pkt.
Version 6 , panel mounting frame with USB coupling:			
Slot V6 with USB-B	CUC-V06-F1PGY-UBB/UBAB	1411905	1
Slot V6 with USB-A	CUC-V06-F1PGY-UBA/UBBB	1411904	1
USB female insert , 4-pos., female USB to flat-ribbon cable terminal strip, 2.54 pitch, female, type A			
	VS-04-BUA-FK-F/IP67	1653854	1
	VS-04-BUB-FK-F/IP67	1653867	1
USB cable , assembled on one side with USB connector			
Connector type: A, length:0.3 m	VS-04-C-SDA/PH/0,3	1405552	1
Connector type: B, length:0.3 m	VS-04-C-SDB/PH/0,3	1405565	1
Connector type: A on B, length:1.8 m	VS-04-C-SDA/SDB/1,8	1405578	1
Freenet panel mounting frame , Version 6, for round mounting cutout, with seal, without mounting screws			
Military gray RAL 7042	VS-A-F-IP67	1653744	5
Protective cover for Version 6 panel mounting frame			
Military gray RAL 7042	VS-08-SD-F	1652606	5

Data connectors and cables

Cable range

Symbol key



With UL style



Suitable for drag chain applications



Resistant to welding sparks



UV-resistant



Extremely flame-retardant



High temperature resistance



Good oil resistance



Good resistance to chemicals



Suitable for torsional stress



Halogen-free



Transmission properties



Suitable for railway applications

INTERBUS cable, type 900



The INTERBUS type 900 cable is designed for highly flexible use in dry and humid rooms and in harsh industrial environments. The remote bus cable is certified in accordance with the requirements of the INTERBUS Club under No. 117.

The cable is halogen-free and flame-retardant in accordance with VDE 0482, Part 265-2-1/ IEC 332-1. The wire insulation of the inner conductor is made from polyethylene.

Outer sheath material PVC

Minimum bending radius 7.5 x D
Tested at 20°C ... 25°C

Type	Number of positions	Application	Structure	Cross section	Wire colors	Wire insulation	Temperature range	Page
900 PVC Green	6-pos.	M12	3 x 2 x 0.25 mm ² 32 x 0.1 mm		Yellow, green, white, brown, pink, gray	PE	-30°C ... 70°C	425 428

PROFIBUS cable, type 910



The PROFIBUS type 910 cable is suitable for drag chain applications and for use in harsh industrial environments, and is oil resistant.

Outer sheath material PUR

Number of bending cycles 5 million
Minimum bending radius 10 x D
Traverse path 10 m
Acceleration 7 m/s²
Speed 3 m/s
Tested at 20°C ... 25°C

Type	Number of positions	Application	Structure	Cross section	Wire colors	Wire insulation	Temperature range	Page
910 PUR Violet	2-pos.	M12	1 x 2 x AWG 24 19 x 0.15 mm		Green, red	PE	-40°C ... 80°C	426 429

DeviceNet™/CANopen® cable, type 920



The DeviceNet™/CANopen® type 920 cable is designed for flexible installation. It is suitable for drag chain applications and use in harsh industrial environments. The cable is also oil resistant.

Outer sheath material PUR
Number of bending cycles 5 million
Minimum bending radius 10 x D
Traverse path 4.5 m
Acceleration 3 m/s²
Speed 3 m/s
Tested at 20°C ... 25°C

Type	Number of positions	Application	Structure	Cross section	Wire colors	Wire insulation	Temperature range	Page
920 PUR Violet	4-pos.	M12, M8	1 x 2 x AWG 22 19 x 0.15 mm + 1 x 2 x AWG 24 19 x 0.15 mm		Red, black, blue, white	PO, PE	-40°C ... 80°C	427 432 433 434

DeviceNet™/CANopen® cable, type 923



The DeviceNet™/CANopen® type 923 cable is designed for flexible installation. It is suitable for drag chain applications and use in harsh industrial environments. The cable is also oil resistant.

Outer sheath material PUR
Number of bending cycles 5 million
Minimum bending radius 10 x D
Traverse path 4.5 m
Acceleration 3 m/s²
Speed 3 m/s
Tested at 20°C ... 25°C

Type	Number of positions	Application	Structure	Cross section	Wire colors	Wire insulation	Temperature range	Page
923 PUR Gray	4-pos.	M12, 7/8"	1 x 2 x AWG 22 19 x 0.15 mm + 1 x 2 x AWG 24 19 x 0.15 mm		Red, black, blue, white	PO, PE	-40°C ... 80°C	431

DeviceNet™ cable, type 928



The DeviceNet™/CANopen® type 928 cable is designed for fixed installation. It is suitable for use in harsh industrial environments and is oil resistant.

Outer sheath material PVC
Minimum bending radius 10 x D

Type	Number of positions	Application	Structure	Cross section	Wire colors	Wire insulation	Temperature range	Page
928 PVC Gray	4-pos.	7/8"	1 x 2 x AWG18 19 x 0.26 mm + 1 x 2 x AWG15 19 x 0.34 mm		Red, black, blue, white	PVC	Fixed: -40°C ... 80°C	See: phoenix contact.net/ products

Data connectors and cables

Cable range

FOUNDATION Fieldbus cable, type 960

FOUNDATION Fieldbus/PROFIBUS PA cable, type 961



The FOUNDATION Fieldbus type 960 cable is designed for fixed installation. It is UV-resistant and flame-retardant in accordance with UL 1685, which means that it is suitable for both indoor and outdoor use.

Cable type 961 is available in a blue version designed specifically for use in the hazardous area.

Outer sheath material PVC

Minimum bending radius 10 x D

Type	Number of positions	Use	Structure	Cross section	Wire colors	Wire insulation	Temperature range	Page
960 PVC Orange	2-pos.	7/8", M12	2 x AWG 20 7 x 0.3 mm		Blue, orange	PO	-30°C ... 105°C	See: phoenix contact.net/ products
961 PVC Blue	2-pos.	7/8", M12	2 x AWG 20 7 x 0.3 mm		Blue, orange	PO	-30°C ... 105°C	430

CC-Link cable, type 990



The CC-Link type 990 cable is designed for fixed indoor installation. The cable is flame-retardant in accordance with UL 1685.

Outer sheath material PVC

Type	Number of positions	Use	Structure	Cross section	Wire colors	Wire insulation	Temperature range	Page
990 PVC Red	3-pos.	M12	3 x AWG 22 7 x 0.28 mm		White, blue, yellow	Foam PE	-30°C ... 60°C	See: phoenix contact.net/ products

PROFINET cable, type 93A



The PROFINET type 93A cable is designed for fixed installation. It is flame-retardant and its transmission properties meet CAT5.

Outer sheath material PVC

Minimum bending radius 7.5 x D

Type	Number of positions	Use	Structure	Cross section	Wire colors	Wire insulation	Temperature range	Page
93A PVC Green	4-pos.	M12, RJ45	4 x AWG 22 single-strand		White, yellow, blue, orange	PE	-25°C ... 80°C	392

PROFINET cable, type 93B



The PROFINET type 93B cable is designed for flexible installation and is oil resistant up to a degree. It is suitable for outdoor use, as it is UV-resistant for 1200 seconds in

accordance with UL 1581. Its transmission properties meet CAT5.

Outer sheath material PVC

Minimum bending radius 7 x D
Tested at 20°C ... 25°C

Type	Number of positions	Use	Structure	Cross section	Wire colors	Wire insulation	Temperature range	Page
93B PVC Green	4-pos.	M12, RJ45	4 x AWG 22 7 x 0.25 mm		White, yellow, blue, orange	PE	-40°C...70°C	394 392 396

PROFINET cable, type 93C



The PROFINET type 93C cable is designed for use in drag chains and is halogen-free and oil resistant. It is UV-resistant and therefore suitable for outdoor use. Its transmission properties meet CAT5.

Outer sheath material PUR

Number of bending cycles 3 million
Minimum bending radius 7.5 x D
Traverse path 10 m
Acceleration 4 m/s²
Speed 4 m/s
Tested at 20°C ... 25°C

Type	Number of positions	Use	Structure	Cross section	Wire colors	Wire insulation	Temperature range	Page
93C PUR Green	4-pos.	M12, RJ45	4 x AWG 22 7 x 0.25 mm		White, yellow, blue, orange	PE	-40°C ... 70°C	392 396

PROFINET cable, type 93R



The PROFINET type 93R cable is designed for robot applications. The cable is oil resistant up to a degree. It is suitable for outdoor use, as it is UV-resistant for

1200 seconds in accordance with UL 1581. Its transmission properties meet CAT5.

Outer sheath material PUR

Torsion angle ±180°
Torsion cycles 1 million

Type	Number of positions	Use	Structure	Cross section	Wire colors	Wire insulation	Temperature range	Page
93R PUR Green	4-pos.	M12, RJ45	4 x AWG 22 19 x 0.15 mm		White, yellow, blue, orange	PE	-40°C ... 80°C	392 396

Cable range

PROFINET cable, type 937



The PROFINET type 937 cable is designed for railway applications. The cable is oil resistant. It meets the requirements of fire protection standards BS 6853, GM/RT 2130, EN 45545, DIN 5510,

NF F16-101, NFPA 130, UNI CEI 11170 and its transmission properties meet CAT5.

Outer sheath material PE-X

Minimum bending radius 6 x D

Type	Number of positions	Use	Structure	Cross section	Wire colors	Wire insulation	Temperature range	Page
937 PE-X Black	4-pos.	M12, RJ45	4 x AWG 22 7 x 0.25 mm		White, yellow, blue, orange	PE-X	-40°C ... 90°C	392 396

PROFINET cable, type 93X



This robust PROFINET cable for outdoor use has good oil and fuel resistance. The black outer sheath and the electron beam cross-linked design provide good protection against the influence of UV radiation. The cable meets the requirements of flame

resistance standard ISO 6722-1, which is referred to by the European ECE-R 118 regulation. This means that the cable can also be used in buses and trams.

Outer sheath material PE-X

Minimum bending radius 6 x D

Type	Number of positions	Use	Structure	Cross section	Wire colors	Wire insulation	Temperature range	Page
93X PE-X Black	4-pos.	M12	4 x AWG 22 7 x 0.25 mm Twisted pair		White, yellow, blue, orange	PE-X	Mobile: -40°C ... 90°C Fixed: -50°C ... 90°C	See: phoenix contact.net/ products

EtherCAT® cable, type 93G

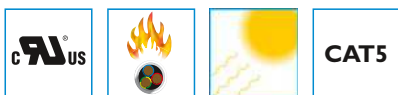

The EtherCAT® type 93G cable is designed for flexible installation. The cable is oil resistant up to a degree. It is suitable for use in harsh industrial environments, as it is UV-resistant for 1200 seconds in

accordance with UL 1581. Its transmission properties meet CAT5.

Outer sheath material PVC

Minimum bending radius 7 x D
Tested at 20°C ... 25°C

Type	Number of positions	Use	Structure	Cross section	Wire colors	Wire insulation	Temperature range	Page
93G PVC Green	4-pos.	M12, PP, RJ45	4 x AWG 22 7 x 0.25 mm		White, yellow, blue, orange	PE	-40°C ... 70°C	See: phoenix contact.net/ products

Sercos® cable, type 93K



The Sercos® cable is designed for flexible installation. The cable is oil resistant up to a degree. It is suitable for use in harsh industrial environments, as it is UV-resistant for 1200 seconds in accordance with UL 1581. Its transmission properties meet CAT5.

Outer sheath material PVC
Minimum bending radius 7 x D
Tested at 20°C ... 25°C

Type	Number of positions	Use	Structure	Cross section	Wire colors	Wire insulation	Temperature range	Page
93K PVC Red	4-pos.	M12, PP, RJ45	4 x AWG 22 7 x 0.25 mm		White, yellow, blue, orange	PE	-40°C ... 70°C	See: phoenix contact.net/ products

Ethernet cable, type 93E



The Ethernet type 93E cable is designed for flexible use. The cable is halogen-free and oil resistant. Its transmission properties meet CAT5.

Outer sheath material PUR
Minimum bending radius 5 x D

Type	Number of positions	Use	Structure	Cross section	Wire colors	Wire insulation	Temperature range	Page
93E PUR Blue	4-pos.	M12, RJ45	2 x 2 x AWG 26 7 x 0.25 mm		White/orange-orange, white/green-green	PE	-20°C ... 80°C	393 398

Ethernet cable, type 94A



The Ethernet type 94A cable is designed for fixed installation. Its transmission properties meet CAT5.

Outer sheath material PUR
Minimum bending radius 7 x D
Tested at 20°C ... 25°C

Type	Number of positions	Use	Structure	Cross section	Wire colors	Wire insulation	Temperature range	Page
94A PUR Blue	8-pos.	M12, PP, RJ45	4 x 2 x AWG 24 single-strand Twisted pair		White/blue-blue, white/orange-orange, white/green-green, white/brown-brown	PE	-20°C ... 70°C	393

Cable range

Ethernet cable, type 94B



The Ethernet type 94B cable is designed for flexible installation. The cable is resistant to oil and chemicals and is flame-retardant. Its transmission properties meet CAT5.

Outer sheath material PUR

Minimum bending radius 5 x D

Type	Number of positions	Use	Structure	Cross section	Wire colors	Wire insulation	Temperature range	Page
94B PUR Blue	8-pos.	M12, RJ45	4 x 2 x AWG 26 7 x 0.25 mm		White/blue-blue, white/orange-orange, white/green-green, white/brown-brown	PE	-40°C ... 80°C	393 400

Ethernet cable, type 94C



The Ethernet cable type 94C is designed for universal use in drag chains. The cable is resistant to oil and chemicals and is flame-retardant. Its transmission properties meet CAT5.

Outer sheath material PUR

Minimum bending radius 5 x D

Type	Number of positions	Use	Structure	Cross section	Wire colors	Wire insulation	Temperature range	Page
94C PUR Blue	8-pos.	M12, RJ45	4 x 2 x AWG 26 19 x 0.10 mm		White-blue, blue, white-orange, orange, white-green, green, white-brown, brown	PP	-20°C ... 80°C	393 400

Ethernet cable, type 94D



The Ethernet cable type 94D is designed for flexible installation. The cable is oil resistant up to a degree. It is suitable for outdoor use, as it is UV-resistant for 1200 seconds in accordance with UL 1581. Its transmission properties meet CAT5.

Outer sheath material PVC

Type	Number of positions	Use	Structure	Cross section	Wire colors	Wire insulation	Temperature range	Page
94D PVC Black	8-pos.	M12, PP, RJ45	4 x 2 x AWG 26 7 x 0.16 mm Twisted pair		White-blue, blue, white-orange, orange, white-green, green, white-brown, brown	PP	-40°C ... 80°C	393

Ethernet cable, type 94E



The Ethernet cable type 94E is designed for fixed installation. The cable is resistant to oil and chemicals and is flame-retardant. It is also halogen-free and its transmission properties meet CAT7.

Outer sheath material FRNC

Type	Number of positions	Use	Structure	Cross section	Wire colors	Wire insulation	Temperature range	Page
94E FRNC Blue	8-pos.	M12, PP, RJ45	4 x 2 x AWG 23 single-strand Twisted pair		White-blue, blue, white-orange, orange, white-green, green, white-brown, brown	PE	-20°C ... 80°C	393

Ethernet cable, type 94F



The Ethernet type 94F cable is designed for flexible installation. The cable is resistant to oil and chemicals and is flame-retardant. It is also halogen-free and its transmission properties meet CAT6_A.

Outer sheath material PUR

Minimum bending radius 10 x D

Type	Number of positions	Use	Structure	Cross section	Wire colors	Wire insulation	Temperature range	Page
94F PUR Blue	8-pos.	M12, PP, RJ45	4 x 2 x AWG 26 7 x 0.16 mm Twisted pair		White-blue, blue, white-orange, orange, white-green, green, white-brown, brown	PE	-20°C ... 80°C	402

Ethernet cable, type 94S



The 94S Ethernet cable is designed for use in the railway industry. The cable is halogen-free and resistant to fuels and ozone. Thanks to its high flame resistance and low smoke density, the cable meets the requirements of the following standards for safety in rail vehicles: BS 6853, DIN 5510-2,

EN 45545-2, EN 50306-4, NF F16-101, NFPA 130, PN-K-02511, and UIC 564-2. Its transmission properties meet CAT7.

Outer sheath material PE-X

Minimum bending radius 6 x D

Type	Number of positions	Use	Structure	Cross section	Wire colors	Wire insulation	Temperature range	Page
94S PE-X Black	8-pos.	M12	4 x 2 x AWG 26 7 x 0.16 mm Twisted pair		White, blue, white, orange, white, green, white, brown	PE-X	-40°C ... 80°C	404

Data connectors and cables

Cable range

Ethernet hybrid cable, type 94H



The Ethernet type 94H hybrid cable is designed for drag chain applications. It has four wires for data transmission and four wires for power supply. The cable is oil resistant and flame-retardant.

It is also halogen-free and its transmission properties are in accordance with CAT5.

Outer sheath material PUR

Number of bending cycles 2 million
Minimum bending radius 10 x D
Traverse path 4.5 m
Acceleration 3 m/s²
Speed 3 m/s

Type	Number of positions	Application	Structure	Cross section	Wire colors	Wire insulation	Temperature range	Page
94H PUR Black	8-pos.	M12	1 x 4 x AWG 26 19 x 0.15 mm 1 x 4 x AWG 20 19 x 0.6 mm		White-orange, orange, white-green, green, white, blue, brown, black	PP	-40°C ... 90°C	405

Ethernet cable, type 94Z



The type 94Z Ethernet cable is designed for flexible installation. The cable is resistant to oil and chemicals and is flame-retardant. Its transmission properties are in accordance with CAT5.

Outer sheath material PUR

Minimum bending radius 51.2 mm

Type	Number of positions	Application	Structure	Cross section	Wire colors	Wire insulation	Temperature range	Page
94Z PUR Blue	8-pos.	RJ45	4 x 2 x AWG 26 7 x 0.16 mm		White-blue, blue, white-orange, orange, white-green, green, white-brown, brown	PE	-20°C ... 80°C	405

VARAN cable, type 970



The VARAN type 970 cable is designed for flexible installation. The cable is resistant to oil and chemicals and is flame-retardant. Its transmission properties are in accordance with CAT5.

Outer sheath material Santoprene

Minimum bending radius 7.5 x D
Tested at 20°C ... 25°C

Type	Number of positions	Application	Structure	Cross section	Wire colors	Wire insulation	Temperature range	Page
970 Santoprene Black	6-pos.	M12, PP, RJ45	1 x 2 x AWG 22 19 x 0.1 mm + 2 x 2 x AWG 26 19 x 0.1 mm		Brown, blue White-orange, orange, white-green, green	PE	-40°C ... 80°C	See: phoenix contact.net/ products



Installation systems

Connect cables quickly and easily without special tools: with the IPD and QPD installation systems from Phoenix Contact.

Depending on the application, choose between simple cable connections, power distributions or device connections. Save up to 80% in cabling time, thanks to the convenient Push-in and QUICKON IDC displacement connection.

IPD installation system

Simply plug in once for a secure connection: Experience simple power distribution in the field with the IPD installation system.

The IPD system is fully plug-in, thanks to the Push-in connection and field-side fast locking system. The IPD system enables the time-saving installation of connectors, panel feed-throughs and distributors up to 5 x 2.5 mm². The convenient handling ensures that this is possible even in difficult installation situation.

QPD installation system

Industrial power distribution does not have to be time-consuming or complicated. The robust QPD installation system is proof of this.

Thanks to the proven QUICKON IDC fast connection, cables up to 5 x 6.0 mm² can be connected quickly and easily, without the need for stripping or special tools.

 Your web code: #0541

IPD installation system

IPD installation system overview **466**

IPD installation system 2.5 mm²

Panel feed-throughs **468**

QPD installation system

QPD installation system overview **470**

QPD installation system 1.5 mm²

H-distributors **472**

T-distributors **473**

Cable connectors **474**

Panel feed-throughs **476**

Connectors **479**

Accessories **480**

QPD installation system 2.5 mm²

H-distributors **481**

T-distributors **482**

Cable connectors **483**

Panel feed-throughs **484**

Connectors **487**

Accessories **488**

QPD installation system 6.0 mm²

H-distributors **489**

T-distributors **490**

Cable connectors **491**

Panel feed-throughs **492**

Connectors **493**

Accessories **494**

QPD special solutions 495

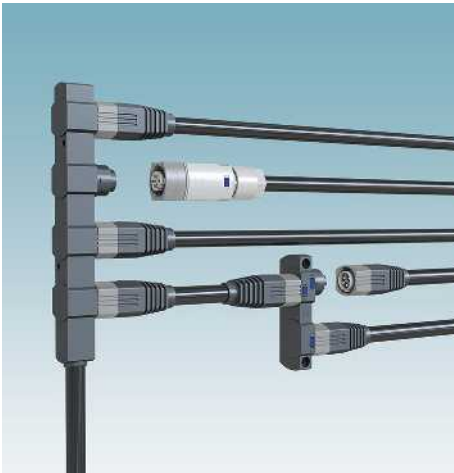

Easy distribution of power

Widely branched buildings or infrastructures place stringent demands on power distribution. The IPD installation system is fully plug-in and enables the tool-free assembly of 3- and 5-pos. cables with a conductor cross section of up to 2.5 mm².



Time-saving wiring in the field

Field-side cabling does not have to be complicated: As a tool-free connection technology, Push-in enables time-saving assembly through the direct plugging of pre-treated and rigid conductors. Simply open the terminal point to connect fine-flexible litz wires and to release a connected conductor.

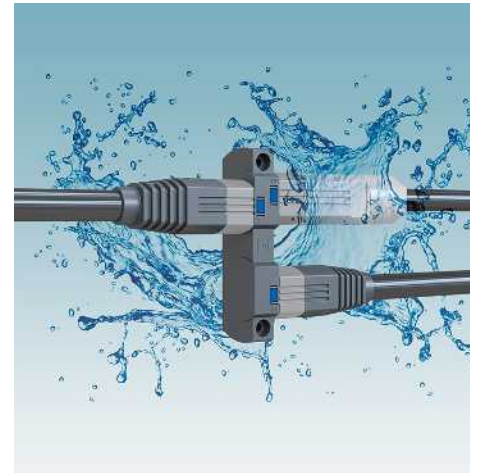

Reliable installation

Long-term stable cabling in outdoor and industrial environments: Thanks to IP67 throughout the entire system, your installation is protected against splash water and dust, for particularly reliable installations in harsh environments.



Simple locking

Installation can be so easy, especially in difficult installation situations. To enable you to work conveniently, even under adverse conditions, the IPD connectors are equipped with a fast locking system.

The plug-in position engages clearly and securely, with polarization against incorrect plugging and touch protection in accordance with DIN EN 0105.



Flexible installation on site

The connectors for assembly facilitate especially great cabling projects considerably. Order connectors that are suitable for your project and adjust the cable length flexibly on site.

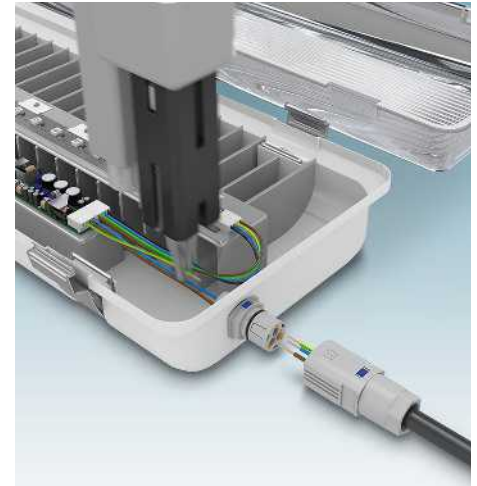

Automated wiring

Thanks to the Push-in connection on the device side, wiring robots can wire the components in the device automatically. The IPD panel feed-throughs are therefore ideal for lighting applications.

Find out more with the web code

Detailed information on these products can be found on our website. Simply enter # followed by the numbers in the search field.



IPD installation system 2.5 mm²

Panel feed-throughs, 2.5 mm², with Push-in connection on both sides

- Devices no longer need to be opened in order to connect the cables
- User-friendly connection, even on devices that are difficult to access
- For internal Push-in connection, rigid conductors are simply stripped and inserted in the connection
- Touch-proof in accordance with DIN EN 50274
- Also available in black



2-pos. + PE

new



4-pos. + PE

new

Technical data	
3+PE-pos.	
General data	
Degree of protection	IP66 / IP68
Electrical data	
Rated voltage (III/3)	690 V
Rated surge voltage	6 kV
Rated current	20 A
Overvoltage category / Degree of pollution	III / 3
Material data	
Housing material	PA
Contact material	Cu
Mechanical data	
Impact category	IK07
Color	light gray
Connection frequency	max. 10
Conductor cross section [mm ²] rigid/flexible	0.5 mm ² ... 2.5 mm ² / 0.5 mm ² ... 2.5 mm ²
Temperature data	
Ambient temperature (operation)	-40°C ... 100°C

Technical data	
4+PE-pos.	
General data	
Degree of protection	IP66 / IP68
Electrical data	
Rated voltage (III/3)	690 V
Rated surge voltage	6 kV
Rated current	20 A
Overvoltage category / Degree of pollution	III / 3
Material data	
Housing material	PA
Contact material	Cu
Mechanical data	
Impact category	IK07
Color	light gray
Connection frequency	max. 10
Conductor cross section [mm ²] rigid/flexible	0.5 mm ² ... 2.5 mm ² / 0.5 mm ² ... 2.5 mm ²
Temperature data	
Ambient temperature (operation)	-40°C ... 100°C

Ordering data		
Type	Order No.	Pcs./Pkt.
IPD WD 3P2.5 M20 GY	1047319	1
IPD WD 3P2,5 M25 GY	1047322	1

Ordering data		
Type	Order No.	Pcs./Pkt.
IPD WD 5P2.5 M25 GY	1047344	1

Ordering data		
Type	Order No.	Pcs./Pkt.
IPD WD 5P2.5 M25 GY	1047344	1

Ordering data		
Type	Order No.	Pcs./Pkt.
IPD WD 5P2.5 M25 GY	1047344	1

Panel feed-throughs, 2.5 mm², with litz wires and Push-in connection on one side

- Devices no longer need to be opened in order to connect the cables
- User-friendly connection, even on devices that are difficult to access
- Touch-proof in accordance with DIN EN 50274
- Also available in black



General data	
Degree of protection	IP66 / IP68
Electrical data	
Rated voltage (III/3)	690 V
Rated surge voltage	6 kV
Rated current	20 A
Overvoltage category / Degree of pollution	III / 3
Material data	
Housing material	PA
Contact material	Cu
Mechanical data	
Impact category	IK07
Color	light gray
Connection frequency	max. 10
Conductor cross section [mm ²] rigid/flexible	0.5 mm ² ... 2.5 mm ² / 0.5 mm ² ... 2.5 mm ²
Temperature data	
Ambient temperature (operation)	-40°C ... 100°C

Technical data	
2+PE-pos.	
Degree of protection	IP66 / IP68
Rated voltage (III/3)	690 V
Rated surge voltage	6 kV
Rated current	20 A
Overvoltage category / Degree of pollution	III / 3
Housing material	PA
Contact material	Cu
Impact category	IK07
Color	light gray
Connection frequency	max. 10
Conductor cross section [mm ²] rigid/flexible	0.5 mm ² ... 2.5 mm ² / 0.5 mm ² ... 2.5 mm ²
Ambient temperature (operation)	-40°C ... 100°C

Technical data	
4+PE-pos.	
Degree of protection	IP66 / IP68
Rated voltage (III/3)	690 V
Rated surge voltage	6 kV
Rated current	20 A
Overvoltage category / Degree of pollution	III / 3
Housing material	PA
Contact material	Cu
Impact category	IK07
Color	light gray
Connection frequency	max. 10
Conductor cross section [mm ²] rigid/flexible	0.5 mm ² ... 2.5 mm ² / 0.5 mm ² ... 2.5 mm ²
Ambient temperature (operation)	-40°C ... 100°C

Ordering data	
Description	Cable length
Panel feed-through, with M20x1.5 mounting flange	0.5 m
	1 m
Panel feed-through, with M25x1.5 mounting flange	0.5 m
	1 m

Ordering data		Type	Order No.	Pcs./Pkt.
Panel feed-through, with M20x1.5 mounting flange	0.5 m	IPD WD 3P2,5 0,5 M20 GY	1047347	1
	1 m	IPD WD 3P2,5 1,0 M20 GY	1047350	1
Panel feed-through, with M25x1.5 mounting flange	0.5 m	IPD WD 3P2,5 0,5 M25 GY	1047354	1
	1 m	IPD WD 3P2,5 1,0 M25 GY	1047356	1

Ordering data		Type	Order No.	Pcs./Pkt.
Panel feed-through, with M20x1.5 mounting flange	0.5 m	IPD WD 5P2,5 0,5 M20 GY	1047360	1
	1 m	IPD WD 5P2,5 1,0 M20 GY	1047364	1
Panel feed-through, with M25x1.5 mounting flange	0.5 m	IPD WD 5P2,5 0,5 M25 GY	1047360	1
	1 m	IPD WD 5P2,5 1,0 M25 GY	1047364	1



Easy distribution of power

With the QPD system you can choose either fixed or plug-in connections to construct flexible distribution solutions. Thanks to the proven QUICKON IDC displacement connection, you can connect cables of up to $5 \times 6.0 \text{ mm}^2$ quickly and easily, without the need for stripping or special tools.



Panel feed-throughs for devices

Convenient installation of a connector begins during the device manufacturer's design-in process. Install the QPD panel feed-throughs directly in the device. The connection can be made on site without having to open the device. The electronics remain continuously protected and the protection class of the device is retained



Reliable installation

The IP66/IP68/IP69K degrees of protection and robust design make the QPD ideal for use outside and in wet areas.



Secure connection in just a few steps

With insulation displacement technology, the cable is connected without stripping the insulation. Simply remove the sheath and prepare the PE conductor. Insert the wires into the nut and snap into the marked wire guides.



Easy assembly without special tools

Cut the ends of the litz wires flush. Then place the union nut onto the contact carrier and tighten.



Fast connection with QUICKON

The fast connection technology automatically establishes the contact and strain relief when tightened. The end position is reached when the connection snaps audibly into place. The connection can be disconnected at any time, which means that components can be reused.

Find out more with the web code

Detailed information on these products can be found on our website. Simply enter # followed by the numbers in the search field.



Installation systems

QPD installation system 1.5 mm²

H-distributors, 1.5 mm²

- Can be used as a H-distributor with continuous master cable
- Can be used as a star distributor
- Can be used as a Y-distributor with a test connection
- Touch-proof in accordance with DIN EN 50274
- Also available in gray color versions



with four QUICKON nuts



without QUICKON nut



	Technical data			Technical data		
	2+PE-pos.	3+PE-pos.	4+PE-pos.	2+PE-pos.	3+PE-pos.	4+PE-pos.
General data						
Degree of protection		IP66 / IP68 / IP69K			IP66 / IP68 / IP69K	
Electrical data						
Rated voltage (III/3)		690 V			690 V	
Rated surge voltage		6 kV			6 kV	
Rated current		17.5 A			17.5 A	
Overvoltage category / Degree of pollution		III / 3			III / 3	
Material data						
Housing material		PA			PA	
Contact material		Cu			Cu	
Flammability rating in accordance with UL 94		V0			V0	
Mechanical data						
Impact category		IK07			IK07	
Color		black			black	
Connector data QUICKON connection						
Core insulation		PVC/PE/TPE/rubber			PVC/PE/TPE/rubber	
Structure of individual litz wire/smallest wire diameter		VDE 0295 class 1 to 6/min. 0.15 mm			VDE 0295 class 1 to 6/min. 0.15 mm	
Connection frequency		max. 10			max. 10	
Conductor cross section [mm ²] rigid/flexible		0.5 mm ² ... 1.5 mm ² / 0.5 mm ² ... 1.5 mm ²			0.5 mm ² ... 1.5 mm ² / 0.5 mm ² ... 1.5 mm ²	
Conductor cross section [AWG]		20 ... 16			20 ... 16	
Temperature data						
Ambient temperature (operation)		-40°C ... 100°C			-40°C ... 100°C	
Temperature when conductor connected		-5°C ... 50°C			-5°C ... 50°C	

Description	Ordering data					
	Order No.	Pcs./ Pkt.	Order No.	Pcs./ Pkt.	Order No.	Pcs./ Pkt.
H-distributor, with four QUICKON nuts and one sealing bolt, for cable diameters:						
4 mm ... 9 mm	1414719	1	1414715	1		
8 mm ... 13 mm	1414720	1	1414716	1		
5 mm ... 10 mm					1414755	1
9 mm ... 14 mm					1414756	1
H-distributor, without QUICKON nuts						
	1414721	1	1414717	1	1414757	1
QUICKON nut, for connections up to 1.5 mm², for cable diameter:						
4 mm ... 9 mm	1415099	1	1415097	1		
8 mm ... 13 mm	1415100	1	1415098	1		
5 mm ... 10 mm					1415101	1
9 mm ... 14 mm					1415104	1

T-distributors, 1.5 mm²

- Can be used as a T-distributor with continuous master cable
- Touch-proof in accordance with DIN EN 50274
- Also available in gray color versions



with three QUICKON nuts



with two QUICKON nuts



	Technical data		
	2+PE-pos.	3+PE-pos.	4+PE-pos.
General data			
Degree of protection		IP66 / IP68 / IP69K	
Electrical data			
Rated voltage (III/3)		690 V	
Rated surge voltage		6 kV	
Rated current		17.5 A	
Overvoltage category / Degree of pollution		III / 3	
Material data			
Housing material		PA	
Contact material		Cu	
Flammability rating in accordance with UL 94		V0	
Mechanical data			
Impact category		IK07	
Color		black	
Connector data QUICKON connection			
Core insulation		PVC/PE/TPE/rubber	
Structure of individual litz wire/smallest wire diameter		VDE 0295 class 1 to 6/min. 0.15 mm	
Connection frequency		max. 10	
Conductor cross section [mm ²] rigid/flexible		0.5 mm ² ... 1.5 mm ² / 0.5 mm ² ... 1.5 mm ²	
Conductor cross section [AWG]		20 ... 16	
Temperature data			
Ambient temperature (operation)		-40°C ... 100°C	
Temperature when conductor connected		-5°C ... 50°C	



	Technical data		
	2+PE-pos.	3+PE-pos.	4+PE-pos.
General data			
Degree of protection		IP66 / IP68 / IP69K	
Electrical data			
Rated voltage (III/3)		690 V	
Rated surge voltage		6 kV	
Rated current		17.5 A	
Overvoltage category / Degree of pollution		III / 3	
Material data			
Housing material		PA	
Contact material		Cu	
Flammability rating in accordance with UL 94		V0	
Mechanical data			
Impact category		IK07	
Color		black	
Connector data QUICKON connection			
Core insulation		PVC/PE/TPE/rubber	
Structure of individual litz wire/smallest wire diameter		VDE 0295 class 1 to 6/min. 0.15 mm	
Connection frequency		max. 10	
Conductor cross section [mm ²] rigid/flexible		0.5 mm ² ... 1.5 mm ² / 0.5 mm ² ... 1.5 mm ²	
Conductor cross section [AWG]		20 ... 16	
Temperature data			
Ambient temperature (operation)		-40°C ... 100°C	
Temperature when conductor connected		-5°C ... 50°C	

Description	Ordering data						
	2+PE-pos.		3+PE-pos.		4+PE-pos.		
	Order No.	Pcs./ Pkt.	Order No.	Pcs./ Pkt.	Order No.	Pcs./ Pkt.	
T-distributor , for cable diameter:							
4 mm ... 9 mm	1414712	1	1414708	1			
8 mm ... 13 mm	1414714	1	1414710	1			
5 mm ... 10 mm					1414753	1	
9 mm ... 14 mm					1414754	1	
QUICKON nut , for connections up to 1.5 mm ² , for cable diameter:							
4 mm ... 9 mm							
8 mm ... 13 mm							
5 mm ... 10 mm						1415101	1
9 mm ... 14 mm						1415104	1

Description	Ordering data						
	2+PE-pos.		3+PE-pos.		4+PE-pos.		
	Order No.	Pcs./ Pkt.	Order No.	Pcs./ Pkt.	Order No.	Pcs./ Pkt.	
T-distributor , for cable diameter:							
4 mm ... 9 mm	1414711	1	1414707	1			
8 mm ... 13 mm	1414713	1	1414709	1			
5 mm ... 10 mm						1414751	1
9 mm ... 14 mm						1414752	1
QUICKON nut , for connections up to 1.5 mm ² , for cable diameter:							
4 mm ... 9 mm	1415099	1	1415097	1			
8 mm ... 13 mm	1415100	1	1415098	1			
5 mm ... 10 mm						1415101	1
9 mm ... 14 mm						1415104	1

QPD installation system 1.5 mm²

Cable connectors, 0.14 mm² ... 1.5 mm²

- Easy cable extension or cable repairs
- The QUICKON connections feature different position markings and mechanical coding
- Touch-proof in accordance with DIN EN 50274



with two QUICKON nuts



with two QUICKON nuts



	Technical data	
	4-pos.	4-pos.
General data		
Degree of protection	IP65 / IP67	
Electrical data		
Rated voltage (III/3)	125 V	250 V
Rated surge voltage	2.5 kV	4 kV
Rated current	5 A	9 A
Overvoltage category / Degree of pollution	III / 3	
Material data		
Housing material	PA	
Contact material	Steel	
Contact surface material	Tin-plated	
Flammability rating in accordance with UL 94	V0	
Impact category	IK06	
Connector data QUICKON connection		
Core insulation	PVC / PE / PP / rubber	
Structure of individual litz wire/smallest wire diameter	VDE 0295 class 1 to 6 / min. 0.10 mm	VDE 0295 class 1 to 6 / min. 0.15 mm
Connection frequency	10	
Conductor cross section [mm ²] rigid/flexible	0.14 mm ² ... 0.25 mm ² / 0.14 mm ² ... 0.34 mm ²	0.34 mm ² ... 0.5 mm ² / 0.34 mm ² ... 0.75 mm ²
Conductor cross section [AWG]	26 ... 22	22 ... 18
Temperature data		
Ambient temperature (operation)	-40°C ... 80°C	
Temperature when conductor connected	-5°C ... 50°C	



	Technical data	
	4-pos.	3+PE-pos.
General data		
Degree of protection	IP65 / IP67	
Electrical data		
Rated voltage (III/3)	500 V	
Rated surge voltage	6 kV	
Rated current	15 A	
Overvoltage category / Degree of pollution	III / 3	
Material data		
Housing material	PA	
Contact material	CuZn	
Contact surface material	Tin-plated	
Flammability rating in accordance with UL 94	V0	
Impact category	IK06	
Connector data QUICKON connection		
Core insulation	PVC / PE	
Structure of individual litz wire/smallest wire diameter	VDE 0295 class 1 to 6 / min. 0.15 mm	
Connection frequency	10	
Conductor cross section [mm ²] rigid/flexible	0.75 mm ² ... 1 mm ² / 0.75 mm ² ... 1.5 mm ²	
Conductor cross section [AWG]	18 ... 16	
Temperature data		
Ambient temperature (operation)	-40°C ... 80°C	
Temperature when conductor connected	-5°C ... 50°C	

Ordering data

Description
Cable connector , for connecting round cables, for cable diameters:
3.5 mm ... 6 mm, 4-pos.
4.0 mm ... 8 mm, 4-pos.
6 mm ... 12 mm, 4-pos.
6 mm ... 12 mm, 3+PE-pos.

Order No.	Pcs./Pkt.	Order No.	Pcs./Pkt.

Order No.	Pcs./Pkt.	Order No.	Pcs./Pkt.

	4-pos.		4-pos.		4-pos.		3+PE-pos.
	1641879	1	1642140	1	1642153	1	1642182

Cable connectors, 1.5 mm²

- Easy cable extension or cable repairs
- The QUICKON connections at opposite ends feature different position markings and mechanical coding
- The 1.5 mm² connector can be used here instead of the QUICKON nut
- Also available in gray color versions



with two QUICKON nuts



with one QUICKON nut



	Technical data		
	2+PE-pos.	3+PE-pos.	4+PE-pos.
General data			
Degree of protection		IP66 / IP68 / IP69K	
Electrical data			
Rated voltage (III/3)		690 V	
Rated surge voltage		6 kV	
Rated current		17.5 A	
Overvoltage category / Degree of pollution		III / 3	
Material data			
Housing material		PA	
Contact material		Cu	
Contact surface material		silver-plated	
Flammability rating in accordance with UL 94		V0	
Impact category		IK07	
Color		black	
Connector data QUICKON connection			
Core insulation		PVC/PE/TPE/rubber	
Structure of individual litz wire/smallest wire diameter		VDE 0295 class 1 to 6/min. 0.15 mm	
Connection frequency		10	
Conductor cross section [mm ²] rigid/flexible		0.5 mm ² ... 1.5 mm ² / 0.5 mm ² ... 1.5 mm ²	
Conductor cross section [AWG]		20 ... 16	
Temperature data			
Ambient temperature (operation)		-40°C ... 100°C	
Temperature when conductor connected		-5°C ... 50°C	

	Technical data		
	2+PE-pos.	3+PE-pos.	4+PE-pos.
General data			
Degree of protection		IP66 / IP68 / IP69K	
Electrical data			
Rated voltage (III/3)		690 V	
Rated surge voltage		6 kV	
Rated current		17.5 A	
Overvoltage category / Degree of pollution		III / 3	
Material data			
Housing material		PA	
Contact material		Cu	
Contact surface material		silver-plated	
Flammability rating in accordance with UL 94		V0	
Impact category		IK07	
Color		black	
Connector data QUICKON connection			
Core insulation		PVC/PE/TPE/rubber	
Structure of individual litz wire/smallest wire diameter		VDE 0295 class 1 to 6/min. 0.15 mm	
Connection frequency		10	
Conductor cross section [mm ²] rigid/flexible		0.5 mm ² ... 1.5 mm ² / 0.5 mm ² ... 1.5 mm ²	
Conductor cross section [AWG]		20 ... 16	
Temperature data			
Ambient temperature (operation)		-40°C ... 100°C	
Temperature when conductor connected		-5°C ... 50°C	

Description	Ordering data						
	Order No.	Pcs./Pkt.	Order No.	Pcs./Pkt.	Order No.	Pcs./Pkt.	
	2+PE-pos.		3+PE-pos.		4+PE-pos.		
Cable connector , for cable diameter:							
4 mm ... 9 mm	1414700	1	1414696	1			
8 mm ... 13 mm	1414702	1	1414698	1			
5 mm ... 10 mm					1414740	1	
9 mm ... 14 mm					1414742	1	
QUICKON nut , for connections up to 1.5 mm ² , for cable diameter:							
4 mm ... 9 mm							
8 mm ... 13 mm							
5 mm ... 10 mm						1415101	1
9 mm ... 14 mm						1415104	1

Description	Ordering data						
	Order No.	Pcs./Pkt.	Order No.	Pcs./Pkt.	Order No.	Pcs./Pkt.	
	2+PE-pos.		3+PE-pos.		4+PE-pos.		
Cable connector , for cable diameter:							
4 mm ... 9 mm	1414699	1	1414694	1			
8 mm ... 13 mm	1414701	1	1414697	1			
5 mm ... 10 mm						1414739	1
9 mm ... 14 mm						1414741	1
QUICKON nut , for connections up to 1.5 mm ² , for cable diameter:							
4 mm ... 9 mm	1415099	1	1415097	1			
8 mm ... 13 mm	1415100	1	1415098	1			
5 mm ... 10 mm						1415101	1
9 mm ... 14 mm						1415104	1

QPD installation system 1.5 mm²

Panel feed-throughs, 1.5 mm²

- Devices no longer need to be opened in order to connect the cables
- User-friendly connection, even on devices that are difficult to access
- Touch-proof in accordance with DIN EN 50274



with litz wires



with manual solder or spade connector connection



Technical data

	3+PE-pos.	4-pos.
General data		
Degree of protection	IP65 / IP67	
Electrical data		
Rated voltage (III/3)	500 V	
Rated surge voltage	6 kV	
Rated current	15 A	
Overvoltage category / Degree of pollution	III / 3	
Material data		
Housing material	PA	
Contact material	CuZn	
Contact surface material	Tin-plated	
Flammability rating in accordance with UL 94	V0	
Impact category	IK07	
Color	black	
Connector data QUICKON connection		
Core insulation	PVC / PE	
Structure of individual litz wire/smallest wire diameter	VDE 0295 class 1 to 6/min. 0.15 mm	
Connection frequency	10	
Conductor cross section [mm ²] rigid/flexible	0.75 mm ² ... 1 mm ² / 0.75 mm ² ... 1.5 mm ²	
Conductor cross section [AWG]	18 ... 16	
Temperature data		
Ambient temperature (operation)	-40°C ... 80°C	
Temperature when conductor connected	-5°C ... 50°C	

Technical data

	3-pos.	4-pos.
General data		
Degree of protection	IP65 / IP67	
Electrical data		
Rated voltage (III/3)	500 V	
Rated surge voltage	6 kV	
Rated current	15 A	
Overvoltage category / Degree of pollution	III / 3	
Material data		
Housing material	PA	
Contact material	CuZn	
Contact surface material	Tin-plated	
Flammability rating in accordance with UL 94	V0	
Impact category	IK07	
Color	black	
Connector data QUICKON connection		
Core insulation	PVC / PE	
Structure of individual litz wire/smallest wire diameter	VDE 0295 Cl.2-5, min. wire diameter 0.2 mm	VDE 0295 class 1 to 6/ min. 0.15 mm
Connection frequency	10	
Conductor cross section [mm ²] rigid/flexible	0.75 mm ² ... 1 mm ² / 0.75 mm ² ... 1.5 mm ²	
Conductor cross section [AWG]	18 ... 16	
Temperature data		
Ambient temperature (operation)	-25°C ... 80°C	-40°C ... 80°C
Temperature when conductor connected	-5°C ... 50°C	

Ordering data

Description	Cable length	3+PE-pos.		4-pos.	
		Order No.	Pcs./Pkt.	Order No.	Pcs./Pkt.
Panel feed-through , with 1.5 mm ² litz wire, connecting thread: M20 x 1.5	0.1 m 0.5 m	1584787	10	1585045	10
Panel feed-through , with 4.8 mm x 0.8 mm manual solder/spade connection, connection thread: M20 x 1.5, color: black, terminal marking: L1, N, PE					
Panel feed-through , with 4.8 mm x 0.8 mm manual solder/slip-on connection, connecting thread: M20 x 1.5, color: black					

Ordering data

Order No.	Pcs./Pkt.	Order No.	Pcs./Pkt.
1641594	10		
1641659	10	1643000	10

Panel feed-throughs, 1.5 mm², with litz wires

- Devices no longer need to be opened in order to connect the cables
- User-friendly connection, even on devices that are difficult to access
- Touch-proof in accordance with DIN EN 50274
- Also available in gray color versions



with QUICKON nut



without QUICKON nut



	Technical data		
	2+PE-pos.	3+PE-pos.	4+PE-pos.
General data			
Degree of protection		IP66 / IP68 / IP69K	
Electrical data			
Rated voltage (III/3)		690 V	
Rated surge voltage		6 kV	
Rated current		17.5 A	
Oversvoltage category / Degree of pollution		III / 3	
Material data			
Housing material		PA	
Contact material		Cu	
Flammability rating in accordance with UL 94		V0	
Mechanical data			
Impact category		IK07	
Color		black	
Connector data QUICKON connection			
Core insulation		PVC/PE/TPE/rubber	
Structure of individual litz wire/smallest wire diameter		VDE 0295 class 1 to 6/min. 0.15 mm	
Connection frequency		max. 10	
Conductor cross section [mm ²] rigid/flexible		0.5 mm ² ... 1.5 mm ² / 0.5 mm ² ... 1.5 mm ²	
Conductor cross section [AWG]		20 ... 16	
Temperature data			
Ambient temperature (operation)		-40°C ... 100°C	
Temperature when conductor connected		-5°C ... 50°C	

	Technical data		
	2+PE-pos.	3+PE-pos.	4+PE-pos.
General data			
Degree of protection		IP66 / IP68 / IP69K	
Electrical data			
Rated voltage (III/3)		690 V	
Rated surge voltage		6 kV	
Rated current		17.5 A	
Oversvoltage category / Degree of pollution		III / 3	
Material data			
Housing material		PA	
Contact material		Cu	
Flammability rating in accordance with UL 94		V0	
Mechanical data			
Impact category		IK07	
Color		black	
Connector data QUICKON connection			
Core insulation		PVC/PE/TPE/rubber	
Structure of individual litz wire/smallest wire diameter		VDE 0295 class 1 to 6/min. 0.15 mm	
Connection frequency		max. 10	
Conductor cross section [mm ²] rigid/flexible		0.5 mm ² ... 1.5 mm ² / 0.5 mm ² ... 1.5 mm ²	
Conductor cross section [AWG]		20 ... 16	
Temperature data			
Ambient temperature (operation)		-40°C ... 100°C	
Temperature when conductor connected		-5°C ... 50°C	

Description	Cable length	Ordering data					
		2+PE-pos.		3+PE-pos.		4+PE-pos.	
		Order No.	Pcs./Pkt.	Order No.	Pcs./Pkt.	Order No.	Pcs./Pkt.

Description	Cable length	Ordering data					
		2+PE-pos.		3+PE-pos.		4+PE-pos.	
		Order No.	Pcs./Pkt.	Order No.	Pcs./Pkt.	Order No.	Pcs./Pkt.

Panel feed-through, with M20 x 1.5 mounting flange, with QUICKON nut, for cable diameter:

4 mm ... 9 mm	0.5 m	1414684	1	1414675	1
4 mm ... 9 mm	1 m	1414685	1	1414676	1
8 mm ... 13 mm	0.5 m	1414687	1	1414678	1
8 mm ... 13 mm	1 m	1414688	1	1414679	1

Panel feed-through, with M25 x 1.5 mounting flange, with QUICKON nut, for cable diameters:

5 mm ... 10 mm	0.5 m			1414730	1
5 mm ... 10 mm	1 m			1414731	1
9 mm ... 14 mm	0.5 m			1414733	1
9 mm ... 14 mm	1 m			1414734	1

Panel feed-through, with M20 x 1.5 mounting flange, without QUICKON nut

	0.5 m			1414690	1	1414681	1
	1 m			1414691	1	1414682	1

Panel feed-through, with M25 x 1.5 mounting flange, without QUICKON nut

	0.5 m					1414736	1
	1 m					1414737	1

QUICKON nut, for connections up to 1.5 mm², for cable diameter:

4 mm ... 9 mm		1415099	1	1415097	1	
8 mm ... 13 mm		1415100	1	1415098	1	
5 mm ... 10 mm					1415101	1
9 mm ... 14 mm					1415104	1

Installation systems

QPD installation system 1.5 mm²

Panel feed-throughs, 1.5 mm², with manual solder or spade connector connection

- Devices no longer need to be opened in order to connect the cables
- User-friendly connection, even on devices that are difficult to access
- Also available in gray color versions
- Touch-proof in accordance with DIN EN 50274



with QUICKON nut



without QUICKON nut



	Technical data		
	2+PE-pos.	3+PE-pos.	4+PE-pos.
General data			
Degree of protection		IP66 / IP68 / IP69K	
Electrical data			
Rated voltage (III/3)		690 V	
Rated surge voltage		6 kV	
Rated current		17.5 A	
Overtoltage category / Degree of pollution		III / 3	
Material data			
Housing material		PA	
Contact material		Cu	
Flammability rating in accordance with UL 94		V0	
Mechanical data			
Impact category		IK07	
Color		black	
Connector data QUICKON connection			
Core insulation		PVC/PE/TPE/rubber	
Structure of individual litz wire/smallest wire diameter		VDE 0295 class 1 to 6/min. 0.15 mm	
Connection frequency		max. 10	
Conductor cross section [mm ²] rigid/flexible		0.5 mm ² ... 1.5 mm ² / 0.5 mm ² ... 1.5 mm ²	
Conductor cross section [AWG]		20 ... 16	
Temperature data			
Ambient temperature (operation)		-40°C ... 100°C	
Temperature when conductor connected		-5°C ... 50°C	

	Technical data		
	2+PE-pos.	3+PE-pos.	4+PE-pos.
General data			
Degree of protection		IP66 / IP68 / IP69K	
Electrical data			
Rated voltage (III/3)		690 V	
Rated surge voltage		6 kV	
Rated current		17.5 A	
Overtoltage category / Degree of pollution		III / 3	
Material data			
Housing material		PA	
Contact material		Cu	
Flammability rating in accordance with UL 94		V0	
Mechanical data			
Impact category		IK07	
Color		black	
Connector data QUICKON connection			
Core insulation		PVC/PE/TPE/rubber	
Structure of individual litz wire/smallest wire diameter		VDE 0295 class 1 to 6/min. 0.15 mm	
Connection frequency		max. 10	
Conductor cross section [mm ²] rigid/flexible		0.5 mm ² ... 1.5 mm ² / 0.5 mm ² ... 1.5 mm ²	
Conductor cross section [AWG]		20 ... 16	
Temperature data			
Ambient temperature (operation)		-40°C ... 100°C	
Temperature when conductor connected		-5°C ... 50°C	

	Technical data		
	2+PE-pos.	3+PE-pos.	4+PE-pos.
General data			
Degree of protection		IP66 / IP68 / IP69K	
Electrical data			
Rated voltage (III/3)		690 V	
Rated surge voltage		6 kV	
Rated current		17.5 A	
Overtoltage category / Degree of pollution		III / 3	
Material data			
Housing material		PA	
Contact material		Cu	
Flammability rating in accordance with UL 94		V0	
Mechanical data			
Impact category		IK07	
Color		black	
Connector data QUICKON connection			
Core insulation		PVC/PE/TPE/rubber	
Structure of individual litz wire/smallest wire diameter		VDE 0295 class 1 to 6/min. 0.15 mm	
Connection frequency		max. 10	
Conductor cross section [mm ²] rigid/flexible		0.5 mm ² ... 1.5 mm ² / 0.5 mm ² ... 1.5 mm ²	
Conductor cross section [AWG]		20 ... 16	
Temperature data			
Ambient temperature (operation)		-40°C ... 100°C	
Temperature when conductor connected		-5°C ... 50°C	

Description	Ordering data		
	Order No.	Pcs./ Pkt.	Order No.
Panel feed-through , with M20 x 1.5 mounting flange, with QUICKON nut , for cable diameter:			
4 mm ... 9 mm	1414686	1	1414677
8 mm ... 13 mm	1414689	1	1414680
Panel feed-through , with M25 x 1.5 mounting flange, with QUICKON nut , for cable diameters:			
5 mm ... 10 mm			1414732
9 mm ... 14 mm			1414735
Panel feed-through , with M20 x 1.5 mounting flange, without QUICKON nut			
Panel feed-through , with M25 x 1.5 mounting flange, without QUICKON nut			
QUICKON nut , for connections up to 1.5 mm ² , for cable diameter:			
4 mm ... 9 mm	1415099	1	1415097
8 mm ... 13 mm	1415100	1	1415098
5 mm ... 10 mm			1415101
9 mm ... 14 mm			1415104

Description	Ordering data		
	Order No.	Pcs./ Pkt.	Order No.
Panel feed-through , with M20 x 1.5 mounting flange, with QUICKON nut , for cable diameter:			
4 mm ... 9 mm	1414686	1	1414677
8 mm ... 13 mm	1414689	1	1414680
Panel feed-through , with M25 x 1.5 mounting flange, with QUICKON nut , for cable diameters:			
5 mm ... 10 mm			1414732
9 mm ... 14 mm			1414735
Panel feed-through , with M20 x 1.5 mounting flange, without QUICKON nut			
Panel feed-through , with M25 x 1.5 mounting flange, without QUICKON nut			
QUICKON nut , for connections up to 1.5 mm ² , for cable diameter:			
4 mm ... 9 mm	1415099	1	1415097
8 mm ... 13 mm	1415100	1	1415098
5 mm ... 10 mm			1415101
9 mm ... 14 mm			1415104

Description	Ordering data		
	Order No.	Pcs./ Pkt.	Order No.
Panel feed-through , with M20 x 1.5 mounting flange, with QUICKON nut , for cable diameter:			
4 mm ... 9 mm	1414686	1	1414677
8 mm ... 13 mm	1414689	1	1414680
Panel feed-through , with M25 x 1.5 mounting flange, with QUICKON nut , for cable diameters:			
5 mm ... 10 mm			1414732
9 mm ... 14 mm			1414735
Panel feed-through , with M20 x 1.5 mounting flange, without QUICKON nut			
Panel feed-through , with M25 x 1.5 mounting flange, without QUICKON nut			
QUICKON nut , for connections up to 1.5 mm ² , for cable diameter:			
4 mm ... 9 mm	1415099	1	1415097
8 mm ... 13 mm	1415100	1	1415098
5 mm ... 10 mm			1415101
9 mm ... 14 mm			1415104

Connectors, 1.5 mm²

- With capacitive PE contact
- Compatible with QUICKON connection
- Can be coded using the two red coding profiles to prevent mismatching of similar connectors
- Touch-proof in accordance with DIN EN 50274
- Also available in gray color versions
- With SPEEDCON fast locking system



with gray screw locking



	Technical data		
	2+PE-pos.	3+PE-pos.	4+PE-pos.
General data			
Degree of protection		IP66 / IP68 / IP69K	
Electrical data			
Rated voltage (III/3)		690 V	
Rated surge voltage		6 kV	
Rated current		17.5 A	
Overvoltage category / Degree of pollution		III / 3	
Material data			
Housing material		PA	
Contact material		Cu	
Contact surface material		silver-plated	
Flammability rating in accordance with UL 94		V0	
Impact category		IK07	
Color		black	
Connector data QUICKON connection			
Core insulation		PVC/PE/TPE/rubber	
Structure of individual litz wire/smallest wire diameter		VDE 0295 class 1 to 6/min. 0.15 mm	
Connection frequency		10	
Conductor cross section [mm ²] rigid/flexible		0.5 mm ² ... 1.5 mm ² / 0.5 mm ² ... 1.5 mm ²	
Conductor cross section [AWG]		20 ... 16	
Temperature data			
Ambient temperature (operation)		-40°C ... 100°C	
Temperature when conductor connected		-5°C ... 50°C	

Description	Ordering data					
	Order No.	Pcs./ Pkt.	Order No.	Pcs./ Pkt.	Order No.	Pcs./ Pkt.
	2+PE-pos.		3+PE-pos.		4+PE-pos.	
Connectors , for cable diameters:						
4 mm ... 9 mm	1414705	1	1414703	1		
8 mm ... 13 mm	1414706	1	1414704	1		
5 mm ... 10 mm					1414749	1
9 mm ... 14 mm					1414750	1

Accessories

- Marker labels ① can be stuck onto the middle of the H- and T-distributor
- Red sealing plugs ② can be stuck into the QUICKON nuts easily and create a seal when screwed tight
- Protective caps with retaining cords ③ for closing open QUICKON domes which, for example, are going to be fitted with a connector later
- Locking nuts ④ for fixing the panel feed-throughs to panels that are too thin to have a thread cut in
- Insulating sleeve ⑤ for 4.8 mm spade connections
- Protective caps ⑥ for attaching to the open QUICKON dome
- Protective caps ⑦ at front for attaching to the connector
- Slotted socket wrenches ⑧ enable you to tighten the QUICKON nuts easily and securely
- Red coding profiles ⑨ for preventing QPD connector mix-ups. Simply insert them into the QUICKON dome and connector on the front side. They are marked with an arrow and their symmetrical form enables them to be mounted in four different positions
- Aluminum shielding tape ⑩ prevents the splicing of the braided shield and enables a clean shield connection



		Ordering data		
Description	Type	Order No.	Pcs./Pkt.	
Marker labels, for H- and T-distributors ①				
For plotting and engraving Can be printed using thermal transfer printer	GPE 13X 9 WH	0806932	10	
	EMLP (13X9)R	0819453	1	
Closing cap, for closing unused bore holes in multiple seals and cable glands ②				
Ø 7 mm	SEALING PLUG 7X16 RD	1400255	10	
Ø 10 mm	SEALING PLUG 10X16 RD	1400284	10	
Ø 14 mm	SEALING PLUG 14X22 RD	1400270	10	
Protective cap, for panel feed-throughs, captive, IP68 ③				
1.5 mm ² , 3-, 4-pos. / black	QPD QSK BK 3/4X1,5 FS	1414722	1	
1.5 mm ² , 5-pos. / 2.5 mm ² , 4-pos. / black	QPD QSK BK 5X1,5 FS	1414728	1	
Counter nut, (plastic), to lock the contact carrier from the inside of the device ④				
M20 / wrench size 26 / black	Q-MU-M20 BK	1586099	25	
M25 / wrench size 32 / black	Q-MU M25	1640715	25	
Insulating sleeve, as shock protection for 4.8 mm slip-on sleeves; first slide over the conductor ⑤				
	PT/FS 4,8	1670497	25	
Protective cap, for QUICKON connection, IP50 ⑥				
1.5 mm ² , 3-, 4-pos.	QPD QSK 3/4X1,5	1414723	10	
1.5 mm ² , 5-pos. / 2.5 mm ² , 4-pos.	QPD QSK 5X1,5	1414758	10	
Protective cap, for connectors, IP50 ⑦				
1.5 mm ² , 3-, 4-pos.	QPD PSK 3/4X1,5	1414724	10	
1.5 mm ² , 5-pos. / 2.5 mm ² , 4-pos.	QPD PSK 5X1,5	1414759	10	
Slotted socket wrench for QUICKON nuts and panel feed-throughs ⑧				
1.5 mm ² , 5-pos. / 2.5 mm ² , 4-pos. / wrench size 22 mm	QSS 22	1670206	1	
Coding profile, for insertion into the connector and QUICKON dome ⑨				
	CP-QPD 3/4X1,5	1414729	10	
	CP-QPD 5X1,5	1414760	10	
Shielding tape, for shielded QPD versions ⑩				
	ALU-SB	1404531	100	

H-distributors, 2.5 mm²

- Can be used as a H-distributor with continuous master cable
- Can be used as a star distributor
- Can be used as a Y-distributor with a test connection
- Touch-proof in accordance with DIN EN 50274
- Also available in gray color versions



with four QUICKON nuts



without QUICKON nut

	Technical data		Technical data	
	3+PE-pos.	4+PE-pos.	3+PE-pos.	4+PE-pos.
General data				
Degree of protection	IP66 / IP68 / IP69K		IP66 / IP68 / IP69K	
Electrical data				
Rated voltage (III/3)	690 V		690 V	
Rated surge voltage	6 kV		6 kV	
Rated current	20 A		20 A	
Overvoltage category / Degree of pollution	III / 3		III / 3	
Material data				
Housing material	PA		PA	
Contact material	Cu		Cu	
Flammability rating in accordance with UL 94	V0		V0	
Mechanical data				
Impact category	IK07		IK07	
Color	black		black	
Connector data QUICKON connection				
Core insulation	PVC/PE/TPE/rubber		PVC/PE/TPE/rubber	
Structure of individual litz wire/smallest wire diameter	VDE 0295 class 1 to 6/min. 0.15 mm		VDE 0295 class 1 to 6/min. 0.15 mm	
Connection frequency	max. 10		max. 10	
Conductor cross section [mm ²] rigid/flexible	1 mm ² ... 2.5 mm ² / 1 mm ² ... 2.5 mm ²		1 mm ² ... 2.5 mm ² / 1 mm ² ... 2.5 mm ²	
Conductor cross section [AWG]	16 ... 14		16 ... 14	
Temperature data				
Ambient temperature (operation)	-40°C ... 100°C		-40°C ... 100°C	
Temperature when conductor connected	-5°C ... 50°C		-5°C ... 50°C	
	Ordering data		Ordering data	
Description	Order No.	Pcs./Pkt.	Order No.	Pcs./Pkt.
	3+PE-pos.		4+PE-pos.	
H-distributor, with four QUICKON nuts, for cable diameters:				
6 mm ... 10 mm	1423971	1		
9 mm ... 14 mm	1423972	1		
6 mm ... 11 mm			1406368	1
9 mm ... 16 mm			1406369	1
H-distributor, without QUICKON nuts			1423973	1
				1406370
QUICKON nut, for connections up to 2.5 mm², for cable diameters:				
6 mm ... 10 mm	1423993	1		
9 mm ... 14 mm	1423994	1		
6 mm ... 11 mm				1459663
9 mm ... 16 mm				1459647

Installation systems

QPD installation system 2.5 mm²

T-distributors, 2.5 mm²

- Can be used as a T-distributor with continuous master cable
- Touch-proof in accordance with DIN EN 50274
- Also available in gray color versions



with three QUICKON nuts



with two QUICKON nuts



Technical data

	3+PE-pos.		4+PE-pos.	
	IP66 / IP68 / IP69K	IP68 / IP69K	IP66 / IP68 / IP69K	IP68 / IP69K
General data				
Degree of protection	IP66 / IP68 / IP69K	IP68 / IP69K	IP66 / IP68 / IP69K	IP68 / IP69K
Electrical data				
Rated voltage (III/3)	690 V	690 V	690 V	690 V
Rated surge voltage	6 kV	6 kV	6 kV	6 kV
Rated current	20 A	20 A	20 A	20 A
Oversvoltage category / Degree of pollution	III / 3	III / 3	III / 3	III / 3
Material data				
Housing material	PA	PA	PA	PA
Contact material	Cu	Cu	Cu	Cu
Flammability rating in accordance with UL 94	V0	V0	V0	V0
Mechanical data				
Impact category	IK07	IK07	IK07	IK07
Color	black	black	black	black
Connector data QUICKON connection				
Core insulation	PVC/PE/TPE/rubber	PVC/PE/TPE/rubber	PVC/PE/TPE/rubber	PVC/PE/TPE/rubber
Structure of individual litz wire/smallest wire diameter	VDE 0295 class 1 to 6/ min. 0.15 mm	VDE 0295 class 1 to 6/ min. 0.15 mm	VDE 0295 class 1 to 6/ min. 0.15 mm	VDE 0295 class 1 to 6/ min. 0.15 mm
Connection frequency	max. 10	max. 10	max. 10	max. 10
Conductor cross section [mm ²] rigid/flexible	1 mm ² ... 2.5 mm ² / 1 mm ² ... 2.5 mm ²	1 mm ² ... 2.5 mm ² / 1 mm ² ... 2.5 mm ²	1 mm ² ... 2.5 mm ² / 1 mm ² ... 2.5 mm ²	1 mm ² ... 2.5 mm ² / 1 mm ² ... 2.5 mm ²
Conductor cross section [AWG]	16 ... 14	16 ... 14	16 ... 14	16 ... 14
Temperature data				
Ambient temperature (operation)	-40°C ... 100°C	-40°C ... 100°C	-40°C ... 100°C	-40°C ... 100°C
Temperature when conductor connected	-5°C ... 50°C	-5°C ... 50°C	-5°C ... 50°C	-5°C ... 50°C

Ordering data

Description	3+PE-pos.		4+PE-pos.	
	Order No.	Pcs./Pkt.	Order No.	Pcs./Pkt.
T-distributor , for cable diameter:				
6 mm ... 10 mm	1424045	1		
9 mm ... 14 mm	1424046	1		
6 mm ... 11 mm			1405401	1
9 mm ... 16 mm			1405402	1
QUICKON nut , for connections up to 2.5 mm ² , for cable diameters:				
6 mm ... 10 mm				
9 mm ... 14 mm				
6 mm ... 11 mm				
9 mm ... 16 mm				

Technical data

	3+PE-pos.		4+PE-pos.	
	IP66 / IP68 / IP69K	IP68 / IP69K	IP66 / IP68 / IP69K	IP68 / IP69K
General data				
Degree of protection	IP66 / IP68 / IP69K	IP68 / IP69K	IP66 / IP68 / IP69K	IP68 / IP69K
Electrical data				
Rated voltage (III/3)	690 V	690 V	690 V	690 V
Rated surge voltage	6 kV	6 kV	6 kV	6 kV
Rated current	20 A	20 A	20 A	20 A
Oversvoltage category / Degree of pollution	III / 3	III / 3	III / 3	III / 3
Material data				
Housing material	PA	PA	PA	PA
Contact material	Cu	Cu	Cu	Cu
Flammability rating in accordance with UL 94	V0	V0	V0	V0
Mechanical data				
Impact category	IK07	IK07	IK07	IK07
Color	black	black	black	black
Connector data QUICKON connection				
Core insulation	PVC/PE/TPE/rubber	PVC/PE/TPE/rubber	PVC/PE/TPE/rubber	PVC/PE/TPE/rubber
Structure of individual litz wire/smallest wire diameter	VDE 0295 class 1 to 6/ min. 0.15 mm	VDE 0295 class 1 to 6/ min. 0.15 mm	VDE 0295 class 1 to 6/ min. 0.15 mm	VDE 0295 class 1 to 6/ min. 0.15 mm
Connection frequency	max. 10	max. 10	max. 10	max. 10
Conductor cross section [mm ²] rigid/flexible	1 mm ² ... 2.5 mm ² / 1 mm ² ... 2.5 mm ²	1 mm ² ... 2.5 mm ² / 1 mm ² ... 2.5 mm ²	1 mm ² ... 2.5 mm ² / 1 mm ² ... 2.5 mm ²	1 mm ² ... 2.5 mm ² / 1 mm ² ... 2.5 mm ²
Conductor cross section [AWG]	16 ... 14	16 ... 14	16 ... 14	16 ... 14
Temperature data				
Ambient temperature (operation)	-40°C ... 100°C	-40°C ... 100°C	-40°C ... 100°C	-40°C ... 100°C
Temperature when conductor connected	-5°C ... 50°C	-5°C ... 50°C	-5°C ... 50°C	-5°C ... 50°C

Ordering data

Description	3+PE-pos.		4+PE-pos.	
	Order No.	Pcs./Pkt.	Order No.	Pcs./Pkt.
T-distributor , for cable diameter:				
6 mm ... 10 mm	1424047	1		
9 mm ... 14 mm	1424048	1		
6 mm ... 11 mm			1405403	1
9 mm ... 16 mm			1405404	1
QUICKON nut , for connections up to 2.5 mm ² , for cable diameters:				
6 mm ... 10 mm	1423993	1		
9 mm ... 14 mm	1423994	1		
6 mm ... 11 mm			1459663	1
9 mm ... 16 mm			1459647	1

Cable connectors, 2.5 mm²

- Easy cable extension or cable repairs
- The QUICKON connections at opposite ends feature different position markings and mechanical coding
- The 2.5 mm² connector can be used here instead of the QUICKON nut
- Also available in gray color versions



with two QUICKON nuts



with one QUICKON nut

ERC

	Technical data	
	3+PE-pos.	4+PE-pos.
General data		
Degree of protection	IP66 / IP68 / IP69K	
Electrical data		
Rated voltage (III/3)	690 V	
Rated surge voltage	6 kV	
Rated current	20 A	
Overvoltage category / Degree of pollution	III / 3	
Material data		
Housing material	PA	
Contact material	Cu	
Contact surface material	silver-plated	
Flammability rating in accordance with UL 94	V0	
Impact category	IK07	
Color	black	
Connector data QUICKON connection		
Core insulation	PVC/PE/TPE/rubber	
Structure of individual litz wire/smallest wire diameter	VDE 0295 class 1 to 6/min. 0.15 mm	
Connection frequency	10	
Conductor cross section [mm ²] rigid/flexible	1 mm ² ... 2.5 mm ² / 1 mm ² ... 2.5 mm ²	
Conductor cross section [AWG]	16 ... 14	
Temperature data		
Ambient temperature (operation)	-40°C ... 100°C	
Temperature when conductor connected	-5°C ... 50°C	

ERC

	Technical data	
	3+PE-pos.	4+PE-pos.
General data		
Degree of protection	IP66 / IP68 / IP69K	
Electrical data		
Rated voltage (III/3)	690 V	
Rated surge voltage	6 kV	
Rated current	20 A	
Overvoltage category / Degree of pollution	III / 3	
Material data		
Housing material	PA	
Contact material	Cu	
Contact surface material	silver-plated	
Flammability rating in accordance with UL 94	V0	
Impact category	IK07	
Color	black	
Connector data QUICKON connection		
Core insulation	PVC/PE/TPE/rubber	
Structure of individual litz wire/smallest wire diameter	VDE 0295 class 1 to 6/min. 0.15 mm	
Connection frequency	10	
Conductor cross section [mm ²] rigid/flexible	1 mm ² ... 2.5 mm ² / 1 mm ² ... 2.5 mm ²	
Conductor cross section [AWG]	16 ... 14	
Temperature data		
Ambient temperature (operation)	-40°C ... 100°C	
Temperature when conductor connected	-5°C ... 50°C	

Description	Ordering data			
	Order No.	Pcs./Pkt.	Order No.	Pcs./Pkt.
	3+PE-pos.		4+PE-pos.	
Cable connector , for cable diameter:				
6 mm ... 10 mm	1423989	1		
9 mm ... 14 mm	1423990	1		
6 mm ... 11 mm			1403838	1
9 mm ... 16 mm			1403836	1
QUICKON nut , for connections up to 2.5 mm ² , for cable diameters:				
6 mm ... 10 mm				
9 mm ... 14 mm				
6 mm ... 11 mm				
9 mm ... 16 mm				

Description	Ordering data			
	Order No.	Pcs./Pkt.	Order No.	Pcs./Pkt.
	3+PE-pos.		4+PE-pos.	
Cable connector , for cable diameter:				
6 mm ... 10 mm	1423991	1		
9 mm ... 14 mm	1423992	1		
6 mm ... 11 mm			1403834	1
9 mm ... 16 mm			1403831	1
QUICKON nut , for connections up to 2.5 mm ² , for cable diameters:				
6 mm ... 10 mm	1423993	1		
9 mm ... 14 mm	1423994	1		
6 mm ... 11 mm			1459663	1
9 mm ... 16 mm			1459647	1

Installation systems

QPD installation system 2.5 mm²

Panel feed-throughs, 2.5 mm², with litz wires

- Devices no longer need to be opened in order to connect the cables
- User-friendly connection, even on devices that are difficult to access
- Touch-proof in accordance with DIN EN 50274
- Also available in gray color versions



with QUICKON nut



without QUICKON nut

	Technical data		Technical data		
	3+PE-pos.	4+PE-pos.	3+PE-pos.	4+PE-pos.	
General data	IP66 / IP68 / IP69K		IP66 / IP68 / IP69K		
Degree of protection					
Electrical data					
Rated voltage (III/3)	690 V		690 V		
Rated surge voltage	6 kV		6 kV		
Rated current	20 A		20 A		
Overvoltage category / Degree of pollution	III / 3		III / 3		
Material data					
Housing material	PA		PA		
Contact material	Cu		Cu		
Flammability rating in accordance with UL 94	V0		V0		
Mechanical data					
Impact category	IK07		IK07		
Color	black		black		
Connector data QUICKON connection					
Core insulation	PVC/PE/TPE/rubber		PVC/PE/TPE/rubber		
Structure of individual litz wire/smallest wire diameter	VDE 0295 class 1 to 6/min. 0.15 mm		VDE 0295 class 1 to 6/min. 0.15 mm		
Connection frequency	max. 10		max. 10		
Conductor cross section [mm ²] rigid/flexible	1 mm ² ... 2.5 mm ² / 1 mm ² ... 2.5 mm ²		1 mm ² ... 2.5 mm ² / 1 mm ² ... 2.5 mm ²		
Conductor cross section [AWG]	16 ... 14		16 ... 14		
Temperature data					
Ambient temperature (operation)	-40°C ... 100°C		-40°C ... 100°C		
Temperature when conductor connected	-5°C ... 50°C		-5°C ... 50°C		
	Ordering data				
Description	Cable length	Order No.	Pcs./Pkt.	Order No.	Pcs./Pkt.
		3+PE-pos.		4+PE-pos.	
Panel feed-through, I_N=15 A, with M20 x 1.5 mounting flange, with QUICKON nut, for cable diameters:					
6 mm ... 11 mm	0.5 m			1403725	1
6 mm ... 11 mm	1 m			1403727	1
9 mm ... 16 mm	0.5 m			1403731	1
9 mm ... 16 mm	1 m			1403733	1
Panel feed-through, with M25 x 1.5 mounting flange, with QUICKON nut, for cable diameters:					
6 mm ... 10 mm	0.5 m	1423975	1		
6 mm ... 10 mm	1 m	1423974	1		
9 mm ... 14 mm	0.5 m	1423980	1		
9 mm ... 14 mm	1 m	1423979	1		
6 mm ... 11 mm	0.5 m			1582557	1
6 mm ... 11 mm	1 m			1582558	1
9 mm ... 16 mm	0.5 m			1582561	1
9 mm ... 16 mm	1 m			1582562	1
Panel feed-through, with M20 x 1.5 mounting flange, without QUICKON nut					
	0.5 m				1403737
	1 m				1403739
Panel feed-through, with M25 x 1.5 mounting flange, without QUICKON nut					
	0.5 m			1423983	1
	1 m			1423984	1
					1582565
					1582566
QUICKON nut, for connections up to 2.5 mm², for cable diameters:					
6 mm ... 10 mm				1423993	1
9 mm ... 14 mm				1423994	1
6 mm ... 11 mm					1459663
9 mm ... 16 mm					1459647

Panel feed-throughs, 2.5 mm², with manual solder or spade connector connection

- Devices no longer need to be opened in order to connect the cables
- User-friendly connection, even on devices that are difficult to access
- Also available in gray color versions



with QUICKON nut



without QUICKON nut

	Technical data				Technical data			
	3+PE-pos.		4+PE-pos.		3+PE-pos.		4+PE-pos.	
General data								
Degree of protection	IP66 / IP68 / IP69K				IP66 / IP68 / IP69K			
Electrical data								
Rated voltage (III/3)	690 V		690 V		690 V		690 V	
Rated surge voltage	6 kV		6 kV		6 kV		6 kV	
Rated current	20 A		15 A		20 A		15 A	
Overvoltage category / Degree of pollution	III / 3		III / 3		III / 3		III / 3	
Material data								
Housing material	PA				PA			
Contact material	Cu				Cu			
Flammability rating in accordance with UL 94	V0				V0			
Mechanical data								
Impact category	IK07				IK07			
Color	black				black			
Connector data QUICKON connection								
Core insulation	PVC/PE/TPE/rubber				PVC/PE/TPE/rubber			
Structure of individual litz wire/smallest wire diameter	VDE 0295 class 1 to 6/min. 0.15 mm				VDE 0295 class 1 to 6/min. 0.15 mm			
Connection frequency	max. 10				max. 10			
Conductor cross section [mm ²] rigid/flexible	1 mm ² ... 2.5 mm ²		1 mm ² ... 2.5 mm ²		1 mm ² ... 2.5 mm ²		1 mm ² ... 2.5 mm ²	
Conductor cross section [AWG]	16 ... 14		16 ... 14		16 ... 14		16 ... 14	
Temperature data								
Ambient temperature (operation)	-40°C ... 100°C				-40°C ... 100°C			
Temperature when conductor connected	-5°C ... 50°C				-5°C ... 50°C			
	Ordering data				Ordering data			
Description	Order No.	Pcs./Pkt.	Order No.	Pcs./Pkt.	Order No.	Pcs./Pkt.	Order No.	Pcs./Pkt.
	3+PE-pos.		4+PE-pos.		3+PE-pos.		4+PE-pos.	
Panel feed-through , I _N =15 A, with M20 x 1.5 mounting flange, with QUICKON nut, for cable diameters:								
6 mm ... 11 mm			1403729	1				
9 mm ... 16 mm			1403735	1				
Panel feed-through , with M25 x 1.5 mounting flange, with QUICKON nut, for cable diameters:								
6 mm ... 10 mm	1423976	1						
9 mm ... 14 mm	1423981	1						
6 mm ... 11 mm			1582559	1				
9 mm ... 16 mm			1582563	1				
Panel feed-through , with mounting flange, without QUICKON nut, connecting thread:								
M20, I _N =15 A							1403741	1
Panel feed-through , with M25 x 1.5 mounting flange, without QUICKON nut								
M25, I _N =20 A					1423986	1	1582567	1
QUICKON nut , for connections up to 2.5 mm ² , for cable diameters:								
6 mm ... 10 mm					1423993	1		
9 mm ... 14 mm					1423994	1		
6 mm ... 11 mm							1459663	1
9 mm ... 16 mm							1459647	1

Installation systems

QPD installation system 2.5 mm²

Panel feed-throughs, 2.5 mm², with Push-in connection

- Devices no longer need to be opened in order to connect the cables
- User-friendly connection, even on devices that are difficult to access
- For internal Push-in connection, rigid conductors are simply stripped and inserted in the connection
- Touch-proof in accordance with DIN EN 50274
- Also available in gray color versions



with QUICKON nut



without QUICKON nut

	Technical data		Technical data	
	3+PE-pos.	4+PE-pos.	3+PE-pos.	
General data				
Degree of protection	IP66 / IP68 / IP69K		IP66 / IP68 / IP69K	
Electrical data				
Rated voltage (III/3)	690 V		690 V	
Rated surge voltage	6 kV		6 kV	
Rated current	20 A		20 A	
Overvoltage category / Degree of pollution	III / 3		III / 3	
Material data				
Housing material	PA		PA	
Contact material	Cu		Cu	
Flammability rating in accordance with UL 94	V0		V0	
Mechanical data				
Impact category	IK07		IK07	
Color	black		black	
Connector data QUICKON connection				
Core insulation	PVC/PE/TPE/rubber	PVC/PE/Rubber/TPE	PVC/PE/TPE/rubber	
Structure of individual litz wire/smallest wire diameter	VDE 0295 class 1 to 6/min. 0.15 mm		VDE 0295 class 1 to 6/min. 0.15 mm	
Connection frequency	max. 10		max. 10	
Conductor cross section [mm ²] rigid/flexible	1 mm ² ... 2.5 mm ² / 1 mm ² ... 2.5 mm ²		1 mm ² ... 2.5 mm ² / 1 mm ² ... 2.5 mm ²	
Conductor cross section [AWG]	16 ... 14		16 ... 14	
Temperature data				
Ambient temperature (operation)	-40°C ... 100°C		-40°C ... 100°C	
Temperature when conductor connected	-5°C ... 50°C		-5°C ... 50°C	
	Ordering data			
Description	Order No.	Pcs./Pkt.	Order No.	Pcs./Pkt.
	3+PE-pos.		4+PE-pos.	
Panel feed-through , with M25 x 1.5 mounting flange, with QUICKON nut, for cable diameters:				
6 mm ... 10 mm	1423977	1		
9 mm ... 14 mm	1423982	1		
6 mm ... 11 mm			1411432	1
9 mm ... 16 mm			1411433	1
Panel feed-through , with M25 x 1.5 mounting flange, without QUICKON nut				
			1423985	1
QUICKON nut , for connections up to 2.5 mm ² , for cable diameters:				
6 mm ... 10 mm			1423993	1
9 mm ... 14 mm			1423994	1

Connectors, 2.5 mm²

- With capacitive PE contact
- Compatible with QUICKON connection
- Can be coded using the two red coding profiles to prevent mismatching of similar connectors
- Touch-proof in accordance with DIN EN 50274
- Also available in gray color versions
- With SPEEDCON fast locking system



with gray screw locking

Technical data

4+PE-pos.

General data	
Degree of protection	IP66 / IP68 / IP69K
Electrical data	
Rated voltage (III/3)	690 V
Rated surge voltage	6 kV
Rated current	20 A
Overvoltage category / Degree of pollution	III / 3
Material data	
Housing material	PA
Contact material	Cu
Contact surface material	silver-plated
Flammability rating in accordance with UL 94	V0
Impact category	IK07
Color	black
Connector data QUICKON connection	
Core insulation	PVC/PE/TPE/rubber
Structure of individual litz wire/smallest wire diameter	VDE 0295 class 1 to 6/min. 0.15 mm
Connection frequency	10
Conductor cross section [mm ²] rigid/flexible	1 mm ² ... 2.5 mm ² / 1 mm ² ... 2.5 mm ²
Conductor cross section [AWG]	16 ... 14
Temperature data	
Ambient temperature (operation)	-40°C ... 100°C
Temperature when conductor connected	-5°C ... 50°C

Ordering data

Description	Type	Order No.	Pcs./Pkt.
Connectors , for cable diameters:			
6 mm ... 11 mm	QPD P 4PE2,5 6-11 TL BK	1039563	1
9 mm ... 16 mm	QPD P 4PE2,5 9-16 TL BK	1039561	1

Accessories

- Marker labels ① can be stuck onto the middle of the H- and T-distributor
- Red sealing plugs ② can be stuck into the QUICKON nuts easily and create a seal when screwed tight
- Protective caps with retaining cords ③ for closing open QUICKON domes which, for example, are going to be fitted with a connector later
- Locking nuts ④ for fixing the panel feed-throughs to panels that are too thin to have a thread cut in
- Insulating sleeve ⑤ for 4.8 mm spade connections
- Protective caps ⑥ for attaching to the open QUICKON dome
- Protective caps ⑦ at front for attaching to the connector
- Slotted socket wrenches ⑧ enable you to tighten the QUICKON nuts easily and securely
- Red coding profiles ⑨ for preventing QPD connector mix-ups. Simply insert them into the QUICKON dome and connector on the front side. They are marked with an arrow and their symmetrical form enables them to be mounted in four different positions
- AS-i seals ⑩ for connecting 1 or 2 AS-i cables
- Aluminum shielding tape ⑪ prevents the splicing of the braided shield and enables a clean shield connection



		Ordering data		
Description		Type	Order No.	Pcs./Pkt.
Marker labels , for H- and T-distributors ①				
For plotting and engraving Can be printed using thermal transfer printer		GPE 13X 9 WH EMLP (13X9)R	0806932 0819453	10 1
Closing cap , for closing unused bore holes in multiple seals and cable glands ②				
Ø 10 mm Ø 14 mm		SEALING PLUG 10X16 RD SEALING PLUG 14X22 RD	1400284 1400270	10 10
Protective cap , for panel feed-throughs, captive, IP68 ③				
1.5 mm ² , 5-pos. / 2.5 mm ² , 4-pos. / black		QPD QSK BK 5X1,5 FS	1414728	1
2.5 mm ² , 5-pos. / gray		QPD QSK GY 5X2,5 FS	1404526	1
2.5 mm ² , 5-pos. / black		QPD QSK BK 5X2,5 FS	1404525	1
Counter nut , (plastic), to lock the contact carrier from the inside of the device ④				
M20 / wrench size 26 / black M25 / wrench size 32 / black		Q-MU-M20 BK Q-MU M25	1586099 1640715	25 25
Insulating sleeve , as shock protection for 4.8 mm slip-on sleeves; first slide over the conductor ⑤				
		PT/FS 4,8	1670497	25
Protective cap , for QUICKON connection, IP50 ⑥				
1.5 mm ² , 5-pos. / 2.5 mm ² , 4-pos. 2.5 mm ² , 5-pos.		QPD QSK 5X1,5 QPD QSK 5X2,5	1414758 1404528	10 10
Protective cap , for connectors, IP50 ⑦				
1.5 mm ² , 5-pos. / 2.5 mm ² , 4-pos. 2.5 mm ² , 5-pos.		QPD PSK 5X1,5 QPD PSK 5X2,5	1414759 1404529	10 10
Slotted socket wrench for QUICKON nuts and panel feed-throughs ⑧				
1.5 mm ² , 5-pos. / 2.5 mm ² , 4-pos. / wrench size 22 mm		QSS 22	1670206	1
2.5 mm ² , 5-pos. / wrench size 27 mm		QSS 27	1670646	1
Coding profile , for insertion into the connector and QUICKON dome ⑨				
		CP QPD 4X2,5 CP-QPD 5X2,5	1425950 1404530	10 10
Insert seal for: ⑩				
One AS-i cable		KV-DI-PG16-1XASI	1582462	10
Two AS-i cables		KV-DI-PG16-2XASI	1582464	10
Shielding tape , for shielded QPD versions ⑪				
		ALU-SB	1404531	100

H-distributors, 6.0 mm²

- Can be used as a H-distributor with continuous master cable
- Can be used as a star distributor
- Can be used as a Y-distributor with a test connection
- Touch-proof in accordance with DIN EN 50274
- Also available in gray color versions



with four QUICKON nuts



without QUICKON nut



Technical data	
4+PE-pos.	
General data	
Degree of protection	IP66 / IP68 / IP69K
Electrical data	
Rated voltage (III/3)	690 V
Rated surge voltage	6 kV
Rated current	40 A
Overvoltage category / Degree of pollution	III / 3
Material data	
Housing material	PA
Contact material	Cu
Flammability rating in accordance with UL 94	V0
Mechanical data	
Impact category	IK07
Color	black
Connector data QUICKON connection	
Core insulation	PVC/PE/TPE/rubber
Structure of individual litz wire/smallest wire diameter	VDE 0295 class 1 to 6/min. 0.15 mm
Connection frequency	max. 10
Conductor cross section [mm ²] rigid/flexible	2.5 mm ² ... 6 mm ² / 2.5 mm ² ... 6 mm ²
Conductor cross section [AWG]	14 ... 10
Temperature data	
Ambient temperature (operation)	-40°C ... 100°C
Temperature when conductor connected	-5°C ... 50°C

Technical data	
4+PE-pos.	
General data	
Degree of protection	IP66 / IP68 / IP69K
Electrical data	
Rated voltage (III/3)	690 V
Rated surge voltage	6 kV
Rated current	40 A
Overvoltage category / Degree of pollution	III / 3
Material data	
Housing material	PA
Contact material	Cu
Flammability rating in accordance with UL 94	V0
Mechanical data	
Impact category	IK07
Color	black
Connector data QUICKON connection	
Core insulation	PVC/PE/TPE/rubber
Structure of individual litz wire/smallest wire diameter	VDE 0295 class 1 to 6/min. 0.15 mm
Connection frequency	max. 10
Conductor cross section [mm ²] rigid/flexible	2.5 mm ² ... 6 mm ² / 2.5 mm ² ... 6 mm ²
Conductor cross section [AWG]	14 ... 10
Temperature data	
Ambient temperature (operation)	-40°C ... 100°C
Temperature when conductor connected	-5°C ... 50°C

Ordering data				
Description	Type	Order No.	Pcs./Pkt.	
H-distributor, with four QUICKON nuts and one sealing bolt, for cable diameters:	9 mm ... 14 mm	QPD H 4PE6,0 4X9-14 BK	1411422	1
	12 mm ... 20 mm	QPD H 4PE6,0 4X12-20 BK	1411425	1
H-distributor, without QUICKON nuts				
QUICKON nut, for connections up to 6.0 mm², for cable diameter:	9 mm ... 14 mm			
	12 mm ... 20 mm			

Ordering data			
Description	Type	Order No.	Pcs./Pkt.
	QPD H 4PE6,0 BK	1411426	1
	QPD N 4PE6,0 9-14 BK	1410409	1
	QPD N 4PE6,0 12-20 BK	1410406	1

Installation systems

QPD installation system 6.0 mm²

T-distributors, 6.0 mm²

- Can be used as a T-distributor with continuous master cable
- Touch-proof in accordance with DIN EN 50274
- Also available in gray color versions



with three QUICKON nuts



with two QUICKON nuts



Technical data

4+PE-pos.

General data	
Degree of protection	IP66 / IP68 / IP69K
Electrical data	
Rated voltage (III/3)	690 V
Rated surge voltage	6 kV
Rated current	40 A
Overvoltage category / Degree of pollution	III / 3
Material data	
Housing material	PA
Contact material	Cu
Flammability rating in accordance with UL 94	V0
Mechanical data	
Impact category	IK07
Color	black
Connector data QUICKON connection	
Core insulation	PVC/PE/TPE/rubber
Structure of individual litz wire/smallest wire diameter	VDE 0295 class 1 to 6/min. 0.15 mm
Connection frequency	max. 10
Conductor cross section [mm ²] rigid/flexible	2.5 mm ² ... 6 mm ² / 2.5 mm ² ... 6 mm ²
Conductor cross section [AWG]	14 ... 10
Temperature data	
Ambient temperature (operation)	-40°C ... 100°C
Temperature when conductor connected	-5°C ... 50°C

IP66 / IP68 / IP69K
690 V
6 kV
40 A
III / 3
PA
Cu
V0
IK07
black
PVC/PE/TPE/rubber
VDE 0295 class 1 to 6/min. 0.15 mm
max. 10
2.5 mm ² ... 6 mm ² / 2.5 mm ² ... 6 mm ²
14 ... 10
-40°C ... 100°C
-5°C ... 50°C

Technical data

4+PE-pos.

IP66 / IP68 / IP69K
690 V
6 kV
40 A
III / 3
PA
Cu
V0
IK07
black
PVC/PE/TPE/rubber
VDE 0295 class 1 to 6/min. 0.15 mm
max. 10
2.5 mm ² ... 6 mm ² / 2.5 mm ² ... 6 mm ²
14 ... 10
-40°C ... 100°C
-5°C ... 50°C

Ordering data

Description	
T-distributor, with three QUICKON nuts, for cable diameter:	
9 mm ... 14 mm	
12 mm ... 20 mm	
T-distributor, with two QUICKON nuts, for cable diameter:	
9 mm ... 14 mm	
12 mm ... 20 mm	
QUICKON nut, for connections up to 6.0 mm², for cable diameter:	
9 mm ... 14 mm	
12 mm ... 20 mm	

Type	Order No.	Pcs./Pkt.
QPD T 4PE6,0 3X9-14 BK	1411414	1
QPD T 4PE6,0 3X12-20 BK	1411415	1

Ordering data

Type	Order No.	Pcs./Pkt.
QPD T 4PE6,0 2X9-14 BK	1411416	1
QPD T 4PE6,0 2X12-20 BK	1411417	1
QPD N 4PE6,0 9-14 BK	1410409	1
QPD N 4PE6,0 12-20 BK	1410406	1

Cable connectors, 6.0 mm²

- Easy cable extension or cable repairs
- The QUICKON connections at opposite ends feature different position markings and mechanical coding
- The 6.0 mm² connector can be used here instead of the QUICKON nut
- Also available in gray color versions



with two QUICKON nuts



with one QUICKON nut



Technical data	
4+PE-pos.	
General data	
Degree of protection	IP66 / IP68 / IP69K
Electrical data	
Rated voltage (III/3)	690 V
Rated surge voltage	6 kV
Rated current	40 A
Overvoltage category / Degree of pollution	III / 3
Material data	
Housing material	PA
Contact material	Cu
Flammability rating in accordance with UL 94	V0
Mechanical data	
Impact category	IK07
Color	black
Connector data QUICKON connection	
Core insulation	PVC/PE/TPE/rubber
Structure of individual litz wire/smallest wire diameter	VDE 0295 class 1 to 6/min. 0.15 mm
Connection frequency	max. 10
Conductor cross section [mm ²] rigid/flexible	2.5 mm ² ... 6 mm ² / 2.5 mm ² ... 6 mm ²
Conductor cross section [AWG]	14 ... 10
Temperature data	
Ambient temperature (operation)	-40°C ... 100°C
Temperature when conductor connected	-5°C ... 50°C

Technical data	
4+PE-pos.	
General data	
Degree of protection	IP66 / IP68 / IP69K
Electrical data	
Rated voltage (III/3)	690 V
Rated surge voltage	6 kV
Rated current	40 A
Overvoltage category / Degree of pollution	III / 3
Material data	
Housing material	PA
Contact material	Cu
Flammability rating in accordance with UL 94	V0
Mechanical data	
Impact category	IK07
Color	black
Connector data QUICKON connection	
Core insulation	PVC/PE/TPE/rubber
Structure of individual litz wire/smallest wire diameter	VDE 0295 class 1 to 6/min. 0.15 mm
Connection frequency	max. 10
Conductor cross section [mm ²] rigid/flexible	2.5 mm ² ... 6 mm ² / 2.5 mm ² ... 6 mm ²
Conductor cross section [AWG]	14 ... 10
Temperature data	
Ambient temperature (operation)	-40°C ... 100°C
Temperature when conductor connected	-5°C ... 50°C

Ordering data			
Description	Type	Order No.	Pcs./Pkt.
Cable connector, with two QUICKON nuts, for cable diameters:			
9 mm ... 14 mm	QPD C 4PE6,0 2X9-14 BK	1410410	1
12 mm ... 20 mm	QPD C 4PE6,0 2X12-20 BK	1410412	1
Cable connector, with one QUICKON nut, for cable diameters:			
9 mm ... 14 mm			
12 mm ... 20 mm			
QUICKON nut, for connections up to 6.0 mm², for cable diameter:			
9 mm ... 14 mm			
12 mm ... 20 mm			

Ordering data			
Description	Type	Order No.	Pcs./Pkt.
Cable connector, with two QUICKON nuts, for cable diameters:			
9 mm ... 14 mm	QPD C 4PE6,0 1X9-14 BK	1410415	1
12 mm ... 20 mm	QPD C 4PE6,0 1X12-20 BK	1410416	1
Cable connector, with one QUICKON nut, for cable diameters:			
9 mm ... 14 mm	QPD N 4PE6,0 9-14 BK	1410409	1
12 mm ... 20 mm	QPD N 4PE6,0 12-20 BK	1410406	1

Installation systems

QPD installation system 6.0 mm²

Panel feed-throughs, 6.0 mm²

- Devices no longer need to be opened in order to connect the cables
- User-friendly connection, even on devices that are difficult to access
- Touch-proof in accordance with DIN EN 50274
- Also available in gray color versions



with one QUICKON nut



without QUICKON nut



Technical data

4+PE-pos.

General data	
Degree of protection	IP66 / IP68 / IP69K
Electrical data	
Rated voltage (III/3)	690 V
Rated surge voltage	6 kV
Rated current	40 A
Overvoltage category / Degree of pollution	III / 3
Material data	
Housing material	PA
Contact material	Cu
Flammability rating in accordance with UL 94	V0
Mechanical data	
Impact category	IK07
Color	black
Connector data QUICKON connection	
Core insulation	PVC/PE/TPE/rubber
Structure of individual litz wire/smallest wire diameter	VDE 0295 class 1 to 6/min. 0.15 mm
Connection frequency	max. 10
Conductor cross section [mm ²] rigid/flexible	2.5 mm ² ... 6 mm ² / 2.5 mm ² ... 6 mm ²
Conductor cross section [AWG]	14 ... 10
Temperature data	
Ambient temperature (operation)	-40°C ... 100°C
Temperature when conductor connected	-5°C ... 50°C



Technical data

4+PE-pos.

General data	
Degree of protection	IP66 / IP68 / IP69K
Electrical data	
Rated voltage (III/3)	690 V
Rated surge voltage	6 kV
Rated current	40 A
Overvoltage category / Degree of pollution	III / 3
Material data	
Housing material	PA
Contact material	Cu
Flammability rating in accordance with UL 94	V0
Mechanical data	
Impact category	IK07
Color	black
Connector data QUICKON connection	
Core insulation	PVC/PE/TPE/rubber
Structure of individual litz wire/smallest wire diameter	VDE 0295 class 1 to 6/min. 0.15 mm
Connection frequency	max. 10
Conductor cross section [mm ²] rigid/flexible	2.5 mm ² ... 6 mm ² / 2.5 mm ² ... 6 mm ²
Conductor cross section [AWG]	14 ... 10
Temperature data	
Ambient temperature (operation)	-40°C ... 100°C
Temperature when conductor connected	-5°C ... 50°C

Ordering data

Description	Cable length
Panel feed-through , with M25 x 1.5 mounting flange, with one QUICKON nut, for cable diameter:	
9 mm ... 14 mm	0.5 m
9 mm ... 14 mm	1 m
12 mm ... 20 mm	0.5 m
12 mm ... 20 mm	1 m
Panel feed-through , with M25 x 1.5 mounting flange, without QUICKON nut	
	0.5 m
	1 m
QUICKON nut , for connections up to 6.0 mm ² , for cable diameter:	
9 mm ... 14 mm	
12 mm ... 20 mm	

Type	Order No.	Pcs./Pkt.
QPD W 4PE6,0 9-14 M25 0,5 BK	1410392	1
QPD W 4PE6,0 9-14 M25 1,0 BK	1410393	1
QPD W 4PE6,0 12-20 M25 0,5 BK	1410394	1
QPD W 4PE6,0 12-20 M25 1,0 BK	1410395	1

Ordering data

Type	Order No.	Pcs./Pkt.
QPD W 4PE6,0 M25 0,5 BK	1410396	1
QPD W 4PE6,0 M25 1,0 BK	1410397	1
QPD N 4PE6,0 9-14 BK	1410409	1
QPD N 4PE6,0 12-20 BK	1410406	1

Connectors 6.0 mm²

- With capacitive PE contact
- Compatible with QUICKON connection
- Can be coded using the two red coding profiles to prevent mismatching of similar connectors
- Touch-proof in accordance with DIN EN 50274
- Also available in gray color versions
- With SPEEDCON fast locking system



with gray screw locking

Technical data

4+PE-pos.

General data	
Degree of protection	IP66 / IP68 / IP69K
Electrical data	
Rated voltage (III/3)	690 V
Rated surge voltage	6 kV
Rated current	40 A
Overvoltage category / Degree of pollution	III / 3
Material data	
Housing material	PA
Contact material	Cu
Contact surface material	silver-plated
Flammability rating in accordance with UL 94	V0
Impact category	IK07
Color	black
Connector data QUICKON connection	
Core insulation	PVC/PE/TPE/rubber
Structure of individual litz wire/smallest wire diameter	VDE 0295 class 1 to 6/min. 0.15 mm
Connection frequency	10
Conductor cross section [mm ²] rigid/flexible	2.5 mm ² ... 6 mm ² / 2.5 mm ² ... 6 mm ²
Conductor cross section [AWG]	14 ... 10
Temperature data	
Ambient temperature (operation)	-40°C ... 100°C
Temperature when conductor connected	-5°C ... 50°C

Ordering data

Description	Type	Order No.	Pcs./Pkt.
Connectors , for cable diameters:			
9 mm ... 14 mm	QPD P 4PE6,0 9-14 TL BK	1039564	1
12 mm ... 20 mm	QPD P 4PE6,0 12-20 TL BK	1039565	1

Accessories

- Marker labels ① can be stuck onto the middle of the H- and T-distributor
- Red sealing plugs ② can be stuck into the QUICKON nuts easily and create a seal when screwed tight
- Protective caps with retaining cords ③ for closing open QUICKON domes which, for example, are going to be fitted with a connector later
- Locking nuts ④ for fixing the panel feed-throughs to panels that are too thin to have a thread cut in
- Insulating sleeve ⑤ for 4.8 mm spade connections
- Protective caps ⑥ for attaching to the open QUICKON dome
- Protective caps ⑦ at front for attaching to the connector
- Red coding profiles ⑧ for preventing QPD connector mix-ups. Simply insert them into the QUICKON dome and connector on the front side. They are marked with an arrow and their symmetrical form enables them to be mounted in four different positions
- Aluminum shielding tape ⑨ prevents the splicing of the braided shield and enables a clean shield connection



		Ordering data		
Description		Type	Order No.	Pcs./Pkt.
Marker labels, for H- and T-distributors	①			
For plotting and engraving Can be printed using thermal transfer printer		GPE 13X 9 WH	0806932	10
		EMLP (13X9)R	0819453	1
Closing cap, for closing unused bore holes in multiple seals and cable glands	②			
Ø 10 mm		SEALING PLUG 10X16 RD	1400284	10
Ø 14 mm		SEALING PLUG 14X22 RD	1400270	10
Protective cap, captive, IP68	③			
6 mm ² , 5-pos. / gray		QPD QSK GY 5X6,0 FS	1411401	1
6 mm ² , 5-pos. / black		QPD QSK BK 5X6,0 FS	1411400	1
Counter nut, (plastic), to lock the contact carrier from the inside of the device	④			
M25 / wrench size 32 / black		Q-MU M25	1640715	25
Insulating sleeve, as shock protection for 4.8 mm slip-on sleeves; first slide over the conductor	⑤			
		PT/FS 4,8	1670497	25
Protective cap, for QUICKON connection, IP50	⑥			
6 mm ² , 5-pos.		QPD QSK 5X6,0	1411403	10
Protective cap, for connectors, IP50	⑦			
6 mm ² , 5-pos.		QPD PSK 5X6,0	1411404	10
Coding profile, for insertion into the connector and QUICKON dome	⑧			
		CP-QPD 5X6,0	1411402	10
Shielding tape, for shielded QPD versions	⑨			
		ALU-SB	1404531	100

Assembled cables, 2.5 mm²

- Connecting cable between two QUICKON connections
- User-friendly connection, even on devices that are difficult to access
- Touch-proof in accordance with DIN EN 50274
- Other versions available on request
- With SPEEDCON fast locking system



4+PE-pos.

EAC

Technical data

General data	
Degree of protection	IP66 / IP68 / IP69K
Electrical data	
Rated voltage (III/3)	690 V
Rated surge voltage	6 kV
Rated current	20 A
Overvoltage category / Degree of pollution	III / 3
Material data	
Housing material	PA
Contact material	Cu
Flammability rating in accordance with UL 94	V0
Mechanical data	
Impact category	IK07
Color	black
Connector data QUICKON connection	
Core insulation	PVC/PE/TPE/rubber
Structure of individual litz wire/smallest wire diameter	VDE 0295 class 1 to 6/min. 0.15 mm
Connection frequency	max. 10
Conductor cross section [mm ²] rigid/flexible	1 mm ² ... 2.5 mm ² / 1 mm ² ... 2.5 mm ²
Conductor cross section [AWG]	16 ... 14
Temperature data	
Ambient temperature (operation)	-40°C ... 100°C
Temperature when conductor connected	-5°C ... 50°C

Ordering data

Description	Cable length	Ordering data		
		Type	Order No.	Pcs./Pkt.
Assembled cable	1 m	QPD 5P/ 1,0-PVC/5P 5X2,5 BK	1408720	1
	3 m	QPD 5P/ 3,0-PVC/5P 5X2,5 BK	1408721	1
	5 m	QPD 5P/ 5,0-PVC/5P 5X2,5 BK	1408722	1
	10 m	QPD 5P/10,0-PVC/5P 5X2,5 BK	1408723	1



Heavy-duty connectors

The right connector for every application

Heavy-duty connectors from the HEAVYCON complete series protect your interfaces and ensure the reliable transmission of power, data, and signals, even under the harshest conditions. They are resistant to dirt, water, vibrations, and high mechanical strain and remain sealed up to IP69K protection. Due to conductive surfaces and seals, all HEAVYCON metal housings are “EMC-ready”.

You can always create the right plug-in connection for your requirements with housings from our series types and matching contact inserts which can be combined.

Compatible insertion, flexible combination

All housing series fit on standard panel cutouts. ADVANCE housings can be mounted directly onto the wall using the panel mounting flange. STANDARD and EVO housings are mounting- and plug-in-compatible with aluminum housings from well-known manufacturers. This allows all components to be individually combined and flexibly modified, extended or exchanged. Our fixed position and modular contact inserts naturally fit into all housing series.

The right connection technology for every application

We offer contact inserts with a wide range of connection technologies. You'll find the right contact insert for every connector housing with intuitive Push-in connection technology.

i Your web code: [#0002](#)

HEAVYCON product range overview

HEAVYCON system cross-reference list	502
Contact inserts and housings	
Series D7	
Contact inserts	504
Housings	514
Series D	
Contact inserts	518
Housings	524
Series B	
Contact inserts	534
Housings	596
Connector sets	646
Compact series	
Contact inserts	648
Housings	650
Accessories	654
DUPLICON stackable power distribution system	672



STANDARD connectors

The robust metal housings of the connectors are resistant to dirt, water, vibration, and high mechanical loads. STANDARD housings have a single or double locking latch. Various supporting base elements such as panel mounting bases, box mounting bases or coupling housings are available as required.



EVO connectors

The EVO connectors are characterized by the patented EVO-Lock system. It allows the cable outlet direction to be freely selected during assembly. It reduces the amount of housing variants required by up to 75%. The EVO housings are plug-in-compatible with aluminum housings from well-known manufacturers. They fit on standard panel cutouts.



ADVANCE connectors

By eliminating the typical panel mounting base, you save on assembly and material costs. The ADVANCE housings with screw locking are suitable for the most stringent requirements, such as particularly aggressive atmospheres and sensitive interfaces.



Contact inserts with a fixed number of positions

The fixed-position inserts are available in a variety of performance classes and with a range of connection technologies. Fast connection technologies, such as Push-in or QUICKON (IDC) connection, enable cable connection within seconds.



Modular contact inserts

Combine the appropriate modules for your application from our wide range of products: HEAVYCON modular includes over 50 contact inserts for signal, power, and data transmission and for pneumatic applications. The innovative module carrier frame with sturdy catch springs enables quick mounting.



Online product configurator

Use our online configurator to quickly and easily configure your connectors. A 3D preview and drag & drop simplify the selection process. The product list can be exported, e-mailed or ordered directly.

i Your web code: #0003



COM connectors

Thanks to their compact design, COM connectors are particularly space saving and are suitable for the cabling of decentral structures in automation technology. The comprehensive product range provides a high level of safety and protection against electromagnetic interferences.

Find out more with the web code

Detailed information on these products can be found on our website. Simply enter # followed by the numbers in the search field.

#0002

Search





HEAVYCON HPR is intended for use in transport and transportation technology. The sleeve housing, panel mounting base, and surface mounting housing meet the increased requirements of the railway industry and are characterized by high vibration resistance. The conductive housing surface provides all-round protection in electromagnetic interference fields. They therefore guarantee the reliable transmission of data, signals, and power, e.g., at carriage transitions. Thanks to their IP68/IP69K degree of protection, the HPR housings can also be used safely outside on the carriage body. Corresponding contact inserts of the B, BB, BBB, DD, HV, and HS range and modular inserts, as well as the square A series extend the portfolio.



Square B series

The HEAVYCON HPR housings in the B series can be securely locked using the robust screw locking mechanism. They are resistant to vibrations and shocks in accordance with IEC 61373 / EN 50155.



Compact D7 series

HEAVYCON D7 housings enable signal and power transmission in a compact design. The new D7 size HPR housings are optimized for railway applications.



Vibration-proof crimp connection

Robust and vibration-proof contact inserts with crimp connection ensure the reliable transmission of signal and power circuits to rail vehicles. You can connect the wire/crimp contact quickly and easily using crimping pliers or a crimping machine.



User-friendly Push-in connection

Contact inserts with Push-in connection technology ensure quick and easy conductor connection: simply insert the conductor directly into the connection without tools, and the gas-tight, vibration- and shock-proof connection is complete.

Find out more
with the web code

Detailed information on these products can be found on our website. Simply enter # followed by the numbers in the search field.

#0520

Search



Heavy-duty connectors

HEAVYCON system cross-reference list – contact inserts and housings

The system cross-reference list illustrates which contact insert matches which housing type.

The upper rows describe the contact insert based on the number of positions, voltage, current, and connection method.

The entries in the columns denote the appropriate housing size.



Configure complete HEAVYCON connectors quickly and easily with our configurator:

i Your web code: #0003

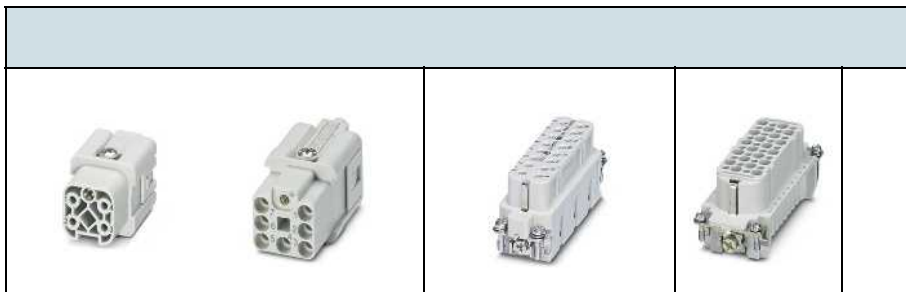

Series	A		D		Q						A			D			D			
Number of positions	3	4	7	8	2	3	4	5	7	12	10	16	2x16	15	25	2x25	40	64	2x40	2x64
Housing size	D7		D7		D7						D15	D25	D50	D15	D25	D50	B16	B24	B32	B48
Rated voltage IEC [V]	230/400		250	50	400	400	830	230/400	400	400	250			250			250			
Rated current IEC [A]	24		10		40	40	40	24	10	10	20			10			10			
Rated voltage UL [V]	600	600	30	600	600	600	600	600	600	600	600			600			600			
Rated current UL [A]	16 - 24		12		50	50	50	24	17.5	15	16 - 19			10			10			

Connection method	A		D		Q						A			D			D			
PT = Push-in	PT										PT									
UT = Screw	UT										UT									
CT = Crimp			CT		CT						CT			CT			CT			
Q = IDC / QUICKON	Q																			
A = Axial screw					A															
P = Pneumatic																				

Series	A		D		Q						A			D			D			
Number of positions	3	4	7	8	2	3	4	5	7	12	10	16	2x16	15	25	2x25	40	64	2x40	2x64
Page	504	504	506	506	510	510	510	508	506	506	518	520	520	522	522	522	534	534	534	534
From 514	•	•	•	•	•	•	•	•	•	•										
From 524											•			•						
From 528												•			•					
From 532													•			•				
From 595																				
From 596																				
From 602																				
From 616																	•			
From 630																		•		
From 644																			•	
From 645																				•

HEAVYCON housings

<p>D7, D15 to D50, and EVO D housings</p>	D7	From 514
	D15	From 524
	D25	From 528
	D50	From 532

<p>EVO M1 sleeve housings, panel mounting bases</p>	M1	From 595
---	-----------	----------

<p>STANDARD, EVO, and ADVANCE housings</p>	B6	From 596
	B10	From 602
	B16	From 616
	B24	From 630
	B32	From 644
	B48	From 645

HEAVYCON contact inserts

HEAVYCON contact inserts																											
DD						B						BB						BBB				HV			HS		M
24	42	72	108	2x72	2x108	6	10	16	24	2x16	2x24	10	18	32	46	2x32	2x46	40	64	2x40	2x64	3+2	6+2	10+2	6	12	Variable
B6	B10	B16	B24	B32	B48	B6	B10	B16	B24	B32	B48	B6	B10	B16	B24	B32	B48	B16	B24	B32	B48	B10	B16	B24	B16	B32	B6 - B48
250						500						500						500				830			400/690		50 - 5000
10						16						16						16				16			41		5 - 200
600						600						600						600				600			600		30 - 600
10						10 - 16						16 - 20						16				16 - 21			35		5 - 146
						PT						PT										PT					PT
						UT																UT					UT
CT						CT						CT						CT				CT					CT
						Q																					A
																											P
DD						B						BB						BBB				HV			HS		M
24	42	72	108	2x72	2x108	6	10	16	24	2x16	2x24	10	18	32	46	2x32	2x46	40	64	2x40	2x64	3+2	6+2	10+2	6	2x6	Variable
538	538	538	538	538	538	540	542	544	546	544	546	552	552	552	552	554	554	556	556	558	558	558	562	562	570		
																										•	
•						•						•														•	
	•						•						•									•				•	
		•						•						•								•				•	
			•						•						•								•			•	
				•						•						•									•	•	
					•						•						•									•	

Heavy-duty connectors

HEAVYCON D7 – contact inserts

A3, A4 series

230 V / 400 V, 10 A ... 24 A

Connection technology:

- Push-in connection
- Screw connection
- Insulation displacement connection

To determine the corresponding housing, see the system cross-reference list on page 502.

Notes:
For accessories, see from page 654
Contact inserts already contain an IP67 sealing screw
Only operate connectors when there is no load/the power is switched off
¹⁾ For flexible wires with wire end protection



Type	Technical data					
	① HC-A03-I-PT...	② HC-A03-I-UT...	③ HC-A3-...Q1,5-TFL-G-PA Sleeve housing	④ HC-A3-...Q1,5-KML-G-PA Coupling housing	⑤ HC-A04-I-PT...	⑥ HC-A04-I-UT...
Approvals						
IEC data						
Rated current, contacts (at 40°C)	[A] 10	24	10	10	10	24
Overvoltage category	III	III	III	III	III	III
Degree of pollution	3	3	3	3	3	3
Rated voltage (III/3) contacts	[V] 230 / 400	230 / 400	230 / 400	230 / 400	230 / 400	230 / 400
Rated surge voltage, contacts	[kV] 4	4	4	4	4	4
Connection cross section	[mm²] 0.14 ... 1.5 ¹⁾	0.5 ... 2.5 ¹⁾	0.75 ... 1.5	0.75 ... 1.5	0.14 ... 1.5 ¹⁾	0.5 ... 2.5 ¹⁾
UL data						
Rated voltage	[V] 600	600	600	600	600	600
Rated current	[A] 17.5	24	10	10	16	24
Connection cross section	AWG 16	14	18-16	18-16	16	14
CSA / cUL data						
Rated voltage	[V] 600	600	600	600	600	600
Rated current	[A] 15	18	10	10	14	18
Connection cross section	AWG 16	14	18-16	18-16	16	14
Material data						
Contact carrier material	PC	PC	PA / PC	PA / PC	PC	PC
Inflammability class in acc. with UL 94	V0	V0	V0	V0	V0	V0
Contact material	-	Copper alloy	Copper alloy	Copper alloy	-	Copper alloy
Contact surface material	Ag	Ag	Ag	Ag	Ag	Ag
Ambient conditions						
Ambient temperature range	[°C] -40 ... 125	-40 ... 125	-25 ... 80	-25 ... 80	-40 ... 125	-40 ... 125
General data						
Connection method	Push-in connection	Screw connection	QUICKON connection	QUICKON connection	Push-in connection	Screw connection
Stripping length	[mm] 10	5	-	-	10	5
Number of positions	3	3	3	3	4	4
Contact numbering	1 - 3	1 - 3	1 - 3	1 - 3	1 - 4	1 - 4
Insertion/withdrawal cycles	≥ 500	≥ 500	≥ 500	≥ 500	≥ 500	≥ 500

Derating curves

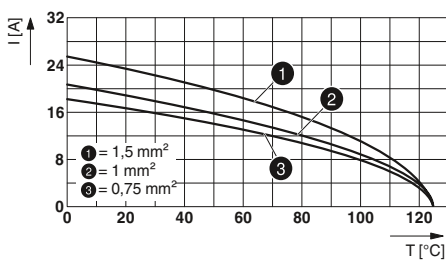



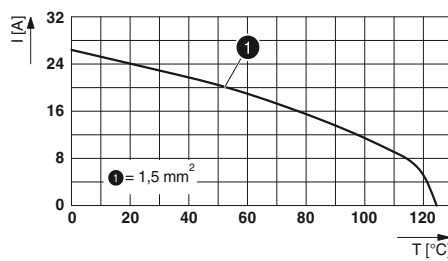

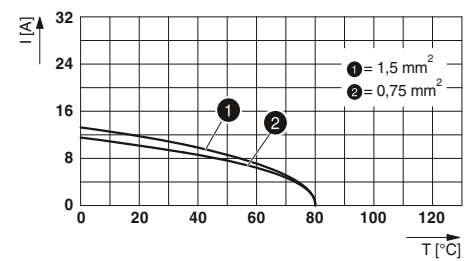

HC-A03-I-PT...

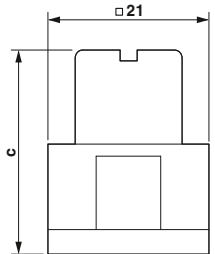

HC-A03-I-UT... / HC-A04-I-UT...

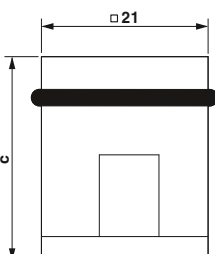

HC-A 3...Q1,5...

Description	Pos.	Number	Size	Type	Ordering data		Pcs./Pkt.	Dimensions (in mm)																																																																	
					Female	Male																																																																			
Push-in connection 	3	1 - 3	D7	① HC-A03-I-PT...	1585265	1585252	1	 Dimensional drawing: female connector																																																																	
Screw connection 	3	1 - 3	D7	② HC-A03-I-UT...	1585223	1585210	1																																																																		
Insulation displacement connection 	3	1 - 3	D7	Sleeve housing ③ HC-A3-...Q1,5-TFL-G-PA	1641510	1641581	1	 Dimensional drawing: male connector																																																																	
Insulation displacement connection 	3	1 - 3	D7	Coupling housing ④ HC-A3-...Q1,5-KML-G-PA	1641617	1641604	1																																																																		
Push-in connection 	4	1 - 4	D7	⑤ HC-A04-I-PT...	1585281	1585278	1	<table border="1"> <thead> <tr> <th></th> <th>a</th> <th>b</th> <th>c</th> <th>d</th> </tr> </thead> <tbody> <tr> <td>① Female</td> <td>21</td> <td></td> <td>28.5</td> <td></td> </tr> <tr> <td>① Male</td> <td></td> <td></td> <td></td> <td></td> </tr> <tr> <td>② Female</td> <td>21</td> <td></td> <td>28</td> <td></td> </tr> <tr> <td>② Male</td> <td></td> <td></td> <td>28.5</td> <td></td> </tr> <tr> <td>③ Female</td> <td>26.5</td> <td></td> <td>66</td> <td></td> </tr> <tr> <td>③ Male</td> <td></td> <td></td> <td></td> <td></td> </tr> <tr> <td>④ Female</td> <td>26.5</td> <td></td> <td>62.8</td> <td></td> </tr> <tr> <td>④ Male</td> <td></td> <td></td> <td></td> <td></td> </tr> <tr> <td>⑤ Female</td> <td>21</td> <td></td> <td>33.5</td> <td></td> </tr> <tr> <td>⑤ Male</td> <td></td> <td></td> <td>34</td> <td></td> </tr> <tr> <td>⑥ Female</td> <td>21</td> <td></td> <td>28.5</td> <td></td> </tr> <tr> <td>⑥ Male</td> <td></td> <td></td> <td></td> <td></td> </tr> </tbody> </table>		a	b	c	d	① Female	21		28.5		① Male					② Female	21		28		② Male			28.5		③ Female	26.5		66		③ Male					④ Female	26.5		62.8		④ Male					⑤ Female	21		33.5		⑤ Male			34		⑥ Female	21		28.5		⑥ Male				
	a	b	c	d																																																																					
① Female	21		28.5																																																																						
① Male																																																																									
② Female	21		28																																																																						
② Male			28.5																																																																						
③ Female	26.5		66																																																																						
③ Male																																																																									
④ Female	26.5		62.8																																																																						
④ Male																																																																									
⑤ Female	21		33.5																																																																						
⑤ Male			34																																																																						
⑥ Female	21		28.5																																																																						
⑥ Male																																																																									
Screw connection 	4	1 - 4	D7	⑥ HC-A04-I-UT...	1585249	1585236	1																																																																		

Accessories



Coding profiles
From page 656



Replacement sealing screws
From page 663

Heavy-duty connectors

HEAVYCON D7 – contact inserts

D7, D8, Q7, Q12 series

50 V ... 400 V, 10 A

Connection technology:

– Crimp connection CK 1,6

To determine the corresponding housing, see the system cross-reference list on page 502.







Notes:
For accessories, see from page 654
Order crimp contacts separately
Only operate connectors when there is no load/the power is switched off
1) Only for plastic housings

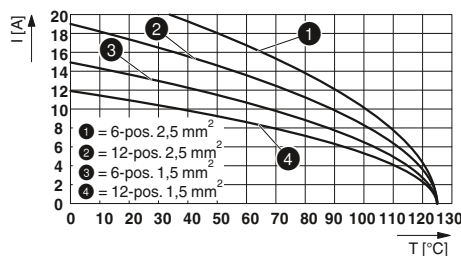
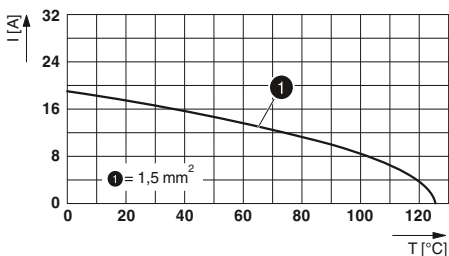

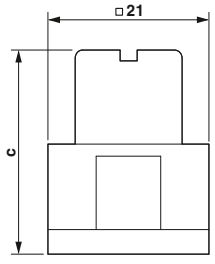
Type	Technical data			
	① HC-D 7-I-CT...	② HC-D 8-I-CT... without PE	③ HC-Q07-I-CT...	④ HC-Q12-I-CT...
Approvals	UL ENEC VDE	UL ENEC VDE	UL ENEC VDE	UL ENEC VDE
IEC data				
Rated current, contacts (at 40°C)	[A] 10	10	10	10
Overtoltage category	III	III	III	III
Degree of pollution	3	3	3	3
Rated voltage (III/3) contacts	[V] 250 ¹⁾	50	400	400
Rated surge voltage, contacts	[kV] 4	0.8	6	6
Connection cross section	[mm ²] 0.14 ... 2.5	0.14 ... 2.5	0.14 ... 2.5	0.14 ... 2.5
UL data				
Rated voltage	[V] 600	600	600	600
Rated current	[A] 12	12	17.5	15
Connection cross section	AWG 14	14	14	14
CSA / cUL data				
Rated voltage	[V] 600	600	600	600
Rated current	[A] 10	10	13.5	12
Connection cross section	AWG 14	14	14	14
Material data				
Contact carrier material	PC	PC	PC	PC
Inflammability class in acc. with UL 94	V0	V0	V0	V0
Contact material	Copper alloy	Copper alloy	Copper alloy	Copper alloy
Contact surface material	Ag (alternatively Au)	Ag (alternatively Au)	Ag (alternatively Au)	Ag (alternatively Au)
Temperature data				
Ambient temperature range	[°C] -40 ... 125	-40 ... 125	-40 ... 125	-40 ... 125
General data				
Connection method	Crimp connection	Crimp connection	Crimp connection	Crimp connection
Stripping length	[mm] 8	8	8	8
Number of positions	7	8	7	12
Contact numbering	1 - 7	1 - 8	1 - 7	1 - 12
Insertion/withdrawal cycles	≥ 500	≥ 500	≥ 500	≥ 500

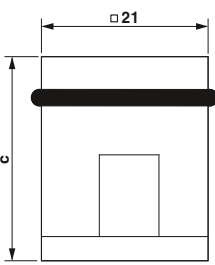
Derating curves



Description	Pos.	Number	Size	Ordering data			Pcs./Pkt.	Dimensions (in mm)																																													
				Type	Female	Male																																															
Crimp connection CK 1,6 	7	1 - 7	D7	① HC-D 7-I-CT...	1584347	1584334	1	 Dimensional drawing: female connector																																													
Crimp connection CK 1,6 	8	1 - 8	D7	without PE ② HC-D 8-I-CT...	1584363	1584350	1																																														
Crimp connection CK 1,6 	7	1 - 7	D7	③ HC-Q07-I-CT...	1418623	1418624	1	 Dimensional drawing: male connector																																													
Crimp connection CK 1,6 	12	1 - 12	D7	④ HC-Q12-I-CT...	1418625	1418626	1																																														
Turned crimp contacts CK 1,6 Silver-plated 								<table border="1"> <thead> <tr> <th></th> <th>a</th> <th>b</th> <th>c</th> <th>d</th> </tr> </thead> <tbody> <tr> <td>① Female</td> <td>21</td> <td></td> <td>32</td> <td></td> </tr> <tr> <td>② Female</td> <td>21</td> <td></td> <td>32</td> <td></td> </tr> <tr> <td>③ Female</td> <td>21</td> <td></td> <td>40.1</td> <td></td> </tr> <tr> <td>④ Female</td> <td>21</td> <td></td> <td>43.1</td> <td></td> </tr> <tr> <td>① Male</td> <td></td> <td></td> <td></td> <td></td> </tr> <tr> <td>② Male</td> <td></td> <td></td> <td></td> <td></td> </tr> <tr> <td>③ Male</td> <td></td> <td></td> <td>39.5</td> <td></td> </tr> <tr> <td>④ Male</td> <td></td> <td></td> <td>40.8</td> <td></td> </tr> </tbody> </table>		a	b	c	d	① Female	21		32		② Female	21		32		③ Female	21		40.1		④ Female	21		43.1		① Male					② Male					③ Male			39.5		④ Male			40.8	
	a	b	c	d																																																	
① Female	21		32																																																		
② Female	21		32																																																		
③ Female	21		40.1																																																		
④ Female	21		43.1																																																		
① Male																																																					
② Male																																																					
③ Male			39.5																																																		
④ Male			40.8																																																		
Cross section mm ² / AWG 0.14 - 0.37 / 26 - 22 0.5 - 0.5 / 20 0.75 - 0.75 / 18 0.75 - 1 / 18 1.5 - 1.5 / 16 2.5 - 2.5 / 14				CK1,6-ED-0,37... AG CK1,6-ED-0,50... AG CK1,6-ED-0,75... AG CK1,6-ED-1,00... AG CK1,6-ED-1,50... AG CK1,6-ED-2,50... AG	1663394 1663404 1663417 1663420 1663433 1663446	1663336 1663349 1663352 1663365 1663378 1663381	100 100 100 100 100 100																																														
Turned crimp contacts CK 1,6 Gold-plated 																																																					
Cross section mm ² / AWG 0.14 - 0.37 / 24 - 22 0.5 - 0.5 / 20 0.75 - 0.75 / 18 0.75 - 1 / 18 1.5 - 1.5 / 16 2.5 - 2.5 / 14				CK1,6-ED-0,37... AU CK1,6-ED-0,50... AU CK1,6-ED-0,75... AU CK1,6-ED-1,00... AU CK1,6-ED-1,50... AU CK1,6-ED-2,50... AU	1674969 1674480 1672440 1674943 1674930 1674985	1674901 1672453 1674914 1674888 1674875 1674927	100 100 100 100 100 100																																														

Accessories



Crimping tools
From page 670



Dummy sockets
phoenixcontact.net/products



Replacement sealing screws
From page 663

Heavy-duty connectors

HEAVYCON D7 – contact inserts

Q5 series

230 V / 400 V, 24 A

Connection technology:

– Crimp connection CK 2,5

To determine the corresponding housing, see the system cross-reference list on page 502.

Notes:
For accessories, see from page 654
Order crimp contacts separately
Only operate connectors when there is no load/the power is switched off



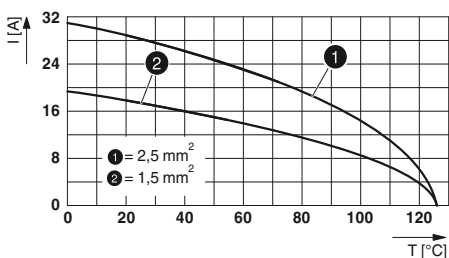

		Technical data			
Type		① HC-Q05-I-CT...			
Approvals					
IEC data					
Rated current, contacts (at 40°C)	[A]	24			
Overtoltage category		III			
Degree of pollution		3			
Rated voltage (III/3) contacts	[V]	230 / 400			
Rated surge voltage, contacts	[kV]	4			
Connection cross section	[mm ²]	0.5 ... 2.5			
UL data					
Rated voltage	[V]	600			
Rated current	[A]	24			
Connection cross section	AWG	14			
CSA / cUL data					
Rated voltage	[V]	600			
Rated current	[A]	15			
Connection cross section	AWG	14			
Material data					
Contact carrier material		PC			
Inflammability class in acc. with UL 94		V0			
Contact material		Copper alloy			
Contact surface material		Ag (alternatively Au)			
Temperature data					
Ambient temperature range	[°C]	-40 ... 125			
General data					
Connection method		Crimp connection			
Hexagonal socket	[mm]	-			
Stripping length	[mm]	7.5			
Number of positions		5			
Contact numbering		1 - 5			
Insertion/withdrawal cycles		≥ 500			

Derating curves

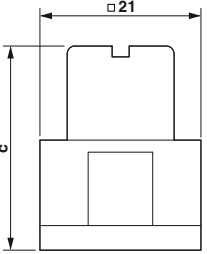
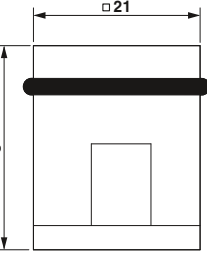

HC-Q05-I-CT...

Description	Pos.	Number	Size	Ordering data			Pcs./ Pkt.	Dimensions (in mm)															
				Type	Order No. Female	Order No. Male																	
Crimp connection CK 2,5 	5	1 - 5	D7	① HC-Q05-I-CT...	1406537	1406538	1	 Dimensional drawing: female connector  Dimensional drawing: male connector															
								<table border="1"> <thead> <tr> <th></th> <th>a</th> <th>b</th> <th>c</th> <th>d</th> </tr> </thead> <tbody> <tr> <td>① Female</td> <td></td> <td></td> <td>40.1</td> <td></td> </tr> <tr> <td>Male</td> <td>21</td> <td></td> <td>39.5</td> <td></td> </tr> </tbody> </table>		a	b	c	d	① Female			40.1		Male	21		39.5	
	a	b	c	d																			
① Female			40.1																				
Male	21		39.5																				
Turned crimp contacts CK 2,5 Silver-plated			Cross section mm ² / AWG																				
			0.5 - 0.5 / 20	CK2,5-ED-0,50... AG	1663640	1663572	100																
			0.75 - 0.75 / 18	CK2,5-ED-0,75... AG	1663653	1663585	100																
			0.75 - 1 / 18	CK2,5-ED-1,00... AG	1663666	1663598	100																
			1.5 - 1.5 / 16	CK2,5-ED-1,50... AG	1663679	1663608	100																
			2.5 - 2.5 / 14	CK2,5-ED-2,50... AG	1663682	1663611	100																
			3 - 3 / 12	CK2,5-ED-3,00... AG	1663695	1663624	100																
Turned crimp contacts CK 2,5 Gold-plated			Cross section mm ² / AWG																				
			0.5 - 0.5 / 20	CK2,5-ED-0,50... AU	1674859	1674804	100																
			0.75 - 1 / 18	CK2,5-ED-1,00... AU	1674833	1674781	100																
			1.5 - 1.5 / 16	CK2,5-ED-1,50... AU	1674820	1674778	100																
			2.5 - 2.5 / 14	CK2,5-ED-2,50... AU	1674862	1674817	100																

Accessories



Crimping tools
From page 670



Dummy sockets
From page 657

Heavy-duty connectors

HEAVYCON D7 – contact inserts

Q2, Q3, Q4 series

400 V, 40 A

Connection technology:

- Axial screw connection
- Crimp connection CK 4,0

To determine the corresponding housing, see the system cross-reference list on page 502.

Notes:
For accessories, see from page 654
Order crimp contacts separately
Only operate connectors when there is no load/the power is switched off
1) Only for plastic housings



Type	Technical data			
	① HC-HS 2-D7-E...S	② HC-Q02-I-CT...	③ HC-Q03-I-CT...	④ HC-Q04-I-CT... without PE
Approvals	ERC ^(B)	ERC	ERC	ERC
IEC data				
Rated current, contacts (at 40°C)	[A] 40	40	40	40
Overvoltage category	III	III	III	III
Degree of pollution	3	3	3	3
Rated voltage (III/3) contacts	[V] 400	400	400	830 ¹⁾
Rated surge voltage, contacts	[kV] 6	6	6	8
Connection cross section	[mm ²] 4 ... 10	1.5 ... 6	1.5 ... 6	1.5 ... 6
UL data				
Rated voltage	[V] -	-	-	-
Rated current	[A] -	-	-	-
Connection cross section	AWG -	-	-	-
CSA / cUL data				
Rated voltage	[V] -	-	-	-
Rated current	[A] -	-	-	-
Connection cross section	AWG -	-	-	-
Material data				
Contact carrier material	PC	PC	PC	PC
Inflammability class in acc. with UL 94	V0	V0	V0	V0
Contact material	Copper alloy	Copper alloy	Copper alloy	Copper alloy
Contact surface material	Ag	Ag	Ag	Ag
Temperature data				
Ambient temperature range	[°C] -40 ... 125	-40 ... 125	-40 ... 125	-40 ... 125
General data				
Connection method	Axial screw connection	Crimp connection	Crimp connection	Crimp connection
Hexagonal socket	[mm] 2	-	-	-
Stripping length	[mm] 8	9	9	9
Number of positions	2	2	3	4
Contact numbering	1 - 2	1 - 2	1 - 2	1 - 4
Insertion/withdrawal cycles	≥ 500	≥ 500	≥ 500	≥ 500

Derating curves

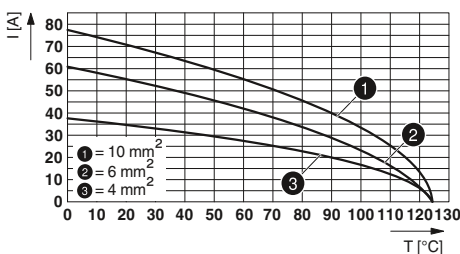



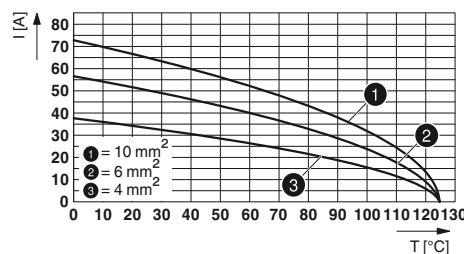

HC-Q02-I-CT...

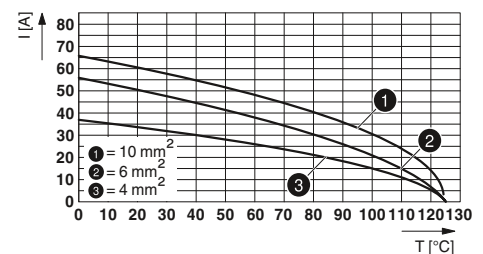

HC-Q03-I-CT...

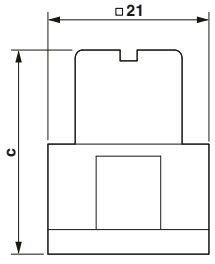
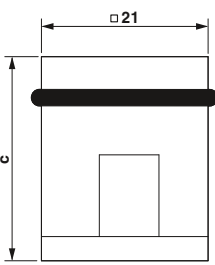

HC-Q04-I-CT...

				Ordering data			Dimensions (in mm)																																																		
Description	Pos.	Number	Size	Type	Order No.		Pcs./Pkt.																																																		
					Female	Male																																																			
Axial screw connection																																																									
	2	1 - 2	D7	① HC-HS 2-D7-E...S	1586264	1586277	10	 <p>Dimensional drawing: female connector</p>  <p>Dimensional drawing: male connector</p>																																																	
Crimp connection CK 4,0																																																									
	2	1 - 2	D7	② HC-Q02-I-CT...	1419895	1419893	1																																																		
Crimp connection CK 4,0																																																									
	3	1 - 2	D7	③ HC-Q03-I-CT...	1419897	1419896	1																																																		
Crimp connection CK 4,0																																																									
	4	1 - 4	D7	without PE ④ HC-Q04-I-CT...	1419899	1419898	1	<table border="1"> <thead> <tr> <th></th> <th>a</th> <th>b</th> <th>c</th> <th>d</th> </tr> </thead> <tbody> <tr> <td>① Female</td> <td></td> <td></td> <td>34.8</td> <td></td> </tr> <tr> <td>① Male</td> <td>21</td> <td></td> <td>40</td> <td></td> </tr> <tr> <td>② Female</td> <td></td> <td></td> <td>34.8</td> <td></td> </tr> <tr> <td>② Male</td> <td>21</td> <td></td> <td>40</td> <td></td> </tr> <tr> <td>③ Female</td> <td></td> <td></td> <td>34.8</td> <td></td> </tr> <tr> <td>③ Male</td> <td>21</td> <td></td> <td>40</td> <td></td> </tr> <tr> <td>④ Female</td> <td></td> <td></td> <td>34.8</td> <td></td> </tr> <tr> <td>④ Male</td> <td>21</td> <td></td> <td>40</td> <td></td> </tr> </tbody> </table>						a	b	c	d	① Female			34.8		① Male	21		40		② Female			34.8		② Male	21		40		③ Female			34.8		③ Male	21		40		④ Female			34.8		④ Male	21		40	
	a	b	c	d																																																					
① Female			34.8																																																						
① Male	21		40																																																						
② Female			34.8																																																						
② Male	21		40																																																						
③ Female			34.8																																																						
③ Male	21		40																																																						
④ Female			34.8																																																						
④ Male	21		40																																																						
Turned crimp contacts CK 4,0 Silver-plated																																																									
								<table border="1"> <thead> <tr> <th></th> <th>Cross section mm² / AWG</th> <th></th> <th></th> <th></th> <th></th> </tr> </thead> <tbody> <tr> <td></td> <td>1.5 - 1.5 / 16</td> <td>CK4,0-ED-1,50... AG</td> <td>1663271</td> <td>1663239</td> <td>25</td> </tr> <tr> <td></td> <td>2.5 - 2.5 / 14</td> <td>CK4,0-ED-2,50... AG</td> <td>1663284</td> <td>1663242</td> <td>25</td> </tr> <tr> <td></td> <td>4 - 4 / 12</td> <td>CK4,0-ED-4,00... AG</td> <td>1663297</td> <td>1663255</td> <td>25</td> </tr> <tr> <td></td> <td>6 - 6 / 10</td> <td>CK4,0-ED-6,00... AG</td> <td>1663307</td> <td>1663268</td> <td>25</td> </tr> <tr> <td></td> <td>10 - 10 / 8</td> <td>CK4,0-ED-10,00... AG</td> <td>1586183</td> <td>1586198</td> <td>25</td> </tr> </tbody> </table>						Cross section mm ² / AWG						1.5 - 1.5 / 16	CK4,0-ED-1,50... AG	1663271	1663239	25		2.5 - 2.5 / 14	CK4,0-ED-2,50... AG	1663284	1663242	25		4 - 4 / 12	CK4,0-ED-4,00... AG	1663297	1663255	25		6 - 6 / 10	CK4,0-ED-6,00... AG	1663307	1663268	25		10 - 10 / 8	CK4,0-ED-10,00... AG	1586183	1586198	25									
	Cross section mm ² / AWG																																																								
	1.5 - 1.5 / 16	CK4,0-ED-1,50... AG	1663271	1663239	25																																																				
	2.5 - 2.5 / 14	CK4,0-ED-2,50... AG	1663284	1663242	25																																																				
	4 - 4 / 12	CK4,0-ED-4,00... AG	1663297	1663255	25																																																				
	6 - 6 / 10	CK4,0-ED-6,00... AG	1663307	1663268	25																																																				
	10 - 10 / 8	CK4,0-ED-10,00... AG	1586183	1586198	25																																																				

Accessories



Crimping tools
From page 670



HC-HS 2... coding profiles
From page 656



Coding profiles
From page 656

Heavy-duty connectors

HEAVYCON D7 – contact inserts

Q series, RJ45 modules

Connection technology:
– RJ45 and RJ1







To determine the corresponding housing, see the system cross-reference list on page 502.

Notes:
For accessories, see from page 654
Only operate connectors when there is no load/the power is switched off

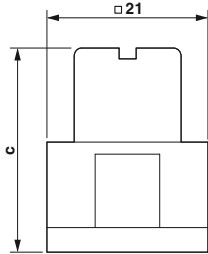
new

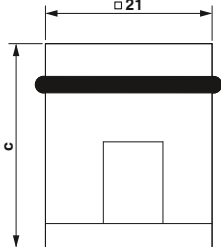

Type	Technical data			
	① HC-Q-I-RJ45 GC-... RJ45, CAT6	② HC-Q-I-RJ45-08-... RJ45, CAT6	③ HC-Q-I-RJ45-AD-PC-... for RJ45 patch cable	④ HC-Q-I-RJ45I-AD-08-PC-... for RJ industrial inserts
Approvals	-	-	-	-
IEC data				
Rated current, contacts (at 40°C)	[A] -	1	1	1
Overvoltage category	III	III	III	III
Degree of pollution	3	3	3	3
Rated voltage (III/3) contacts	[V] -	50	50	50
Rated surge voltage, contacts	[kV] -	0.8	0.8	0.8
Connection cross section	[mm²] -	-	-	-
UL data				
Rated voltage	[V] -	-	-	-
Rated current	[A] -	-	-	-
Connection cross section	AWG -	-	-	-
CSA / cUL data				
Rated voltage	[V] -	-	-	-
Rated current	[A] -	-	-	-
Connection cross section	AWG -	-	-	-
Material data				
Contact carrier material	-	PC	PC	PC
Inflammability class in acc. with UL 94	V0	V0	V0	V0
Contact material	Copper alloy	Copper alloy	Copper alloy	Copper alloy
Contact surface material	-	Au	Au	Au
Temperature data				
Ambient temperature range	[°C] -40 ... 70	-25 ... 60	-25 ... 60	-40 ... 70
General data				
Connection method	-	-	-	-
Stripping length	[mm] -	-	-	-
Number of positions	8	8	8	8
Contact numbering	-	-	-	-
Insulation resistance	[GΩ] -0.1	-	-	-
Contact resistance	[mΩ] -	-	-	-
Insertion/withdrawal cycles	-	-	-	≥ 500

Description	Pos.	Number	Size	Ordering data			Pcs./Pkt.	Dimensions (in mm)																																													
				Type	Order No.																																																
					Female	Male																																															
RJ45 gender changer 	8		D7	RJ45, CAT6 ① HC-Q-I-RJ45 GC-...	1422590		1	 Dimensional drawing: female connector																																													
RJ45 pin insert 	8		D7	RJ45, CAT6 ② HC-Q-I-RJ45-08-...	1077117		1																																														
RJ45 adapter 	8		D7	for RJ45 patch cable ③ HC-Q-I-RJ45-AD-PC-...	1077120		1	 Dimensional drawing: male connector																																													
RJ45 adapter 	8		D7	for RJ industrial inserts ④ HC-Q-I-RJ45I-AD-08-PC-...	1077119		1																																														
RJ45 patch cable Length: 1 m 			CAT6 _A CAT6 CAT5e	NBC-R4AC1/1,0-94G/R4AC1-BU FL CAT6 PATCH 1,0 FL CAT5 PATCH 1,0	1413160 2891385 2832276		1 10 10	<table border="1"> <thead> <tr> <th></th> <th>a</th> <th>b</th> <th>c</th> <th>d</th> </tr> </thead> <tbody> <tr> <td>① Female</td> <td>21</td> <td></td> <td>39</td> <td></td> </tr> <tr> <td>① Male</td> <td></td> <td></td> <td></td> <td></td> </tr> <tr> <td>② Female</td> <td></td> <td></td> <td></td> <td></td> </tr> <tr> <td>② Male</td> <td>21</td> <td></td> <td>22</td> <td></td> </tr> <tr> <td>③ Female</td> <td></td> <td></td> <td></td> <td></td> </tr> <tr> <td>③ Male</td> <td>21</td> <td></td> <td>20.5</td> <td></td> </tr> <tr> <td>④ Female</td> <td></td> <td></td> <td></td> <td></td> </tr> <tr> <td>④ Male</td> <td>21</td> <td></td> <td>35</td> <td></td> </tr> </tbody> </table>		a	b	c	d	① Female	21		39		① Male					② Female					② Male	21		22		③ Female					③ Male	21		20.5		④ Female					④ Male	21		35	
	a	b	c	d																																																	
① Female	21		39																																																		
① Male																																																					
② Female																																																					
② Male	21		22																																																		
③ Female																																																					
③ Male	21		20.5																																																		
④ Female																																																					
④ Male	21		35																																																		
RJ45 connector, IP20, CAT5e 			Cross section mm ² / AWG 0.14 - 0.25 / 26 - 24 0.23 - 0.32 / 23 - 22	CUC-INI-C1ZNI-S/R4IE8 CUC-INI-C1ZNI-S/R4IP8	1421608 1421129		1 1																																														

Accessories



RJ45 patch cables
From page 721

Heavy-duty connectors

HEAVYCON D7 – housings

Size D7, plastic, sleeve housings for single locking latch







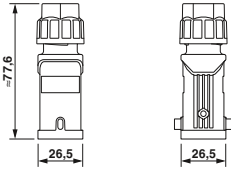

General data

Housing material
Locking latch material
Sealing material
IP degree of protection (when plugged in)
Ambient temperature (operation)

Technical data	
Housing material	PA
Locking latch material	PA
Sealing material	NBR, conductive
IP degree of protection (when plugged in)	IP66
Ambient temperature (operation)	-40°C ... 125°C

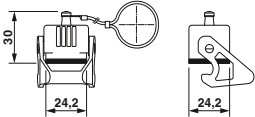

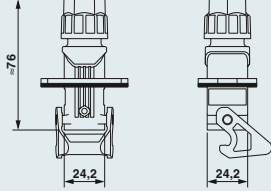
Ordering data

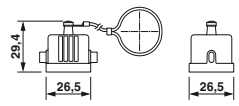
Description	Clamping area	Type	Order No.	Pcs./Pkt.	Dimensions
Sleeve housing Height: 77.6 mm 	4 mm ... 10 mm 10 mm ... 16 mm	HC-STA-D07-HHFS-1TGM20-PL-BK	1419255	1	
		HC-STA-D07-HHFS-1TGM25-PL-BK	1419256	1	
Sleeve housing Height: 54.5 mm 	4 mm ... 10 mm 10 mm ... 16 mm	HC-STA-D07-HHFS-1SGM20-PL-BK	1419257	1	
		HC-STA-D07-HHFS-1SGM25-PL-BK	1419258	1	
Protective cover, for housing sizes: Height: 30 mm 		D7, for female insert HC-STA-D07-HCLWS-PLR-BK	1419274	1	
		D7, for male insert HC-STA-D07-HCLWS-PL-BK	1419275	1	
Feed-through housing, with single locking latch Height: 76 mm 	4 mm ... 10 mm	HC-STA-D07-CHPWS-1TGM20-PL-BK	1419269	1	
Protective cover, for coupling housings: Height: 29.4 mm 		D7, for female insert HC-STA-D07-BCLFS-PLR-BK	1419270	1	
		D7, for male insert HC-STA-D07-BCLFS-PL-BK	1419271	1	

Accessories



Replacement sealing screws
From page 663



Replacement latches
phoenixcontact.net/products









Size D7, metal, sleeve housings for single locking latch

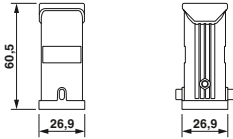

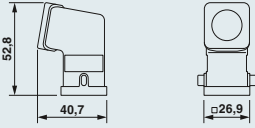
Technical data

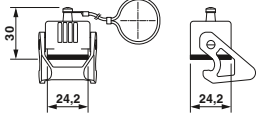
General data	
Housing material	Die-cast aluminum, salt water resistant
Locking latch material	PA
Sealing material	NBR, conductive
IP degree of protection (when plugged in)	IP66 / IP67
Ambient temperature (operation)	-40°C ... 125°C

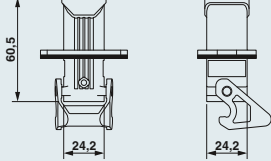
Ordering data

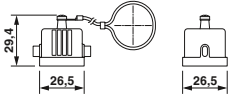
Description	Thread	Type	Order No.	Pcs./Pkt.	Dimensions
Sleeve housing Height: 60.5 mm 	1x M20 1x M25 1x Pg11	HC-STA-D07-HHFS-1TTM20-EL-AL	1419229	1	
		HC-STA-D07-HHFS-1TTM25-EL-AL	1419231	1	
		HC-STA-D07-HHFS-1TTP11-EL-AL	1419232	1	
Sleeve housing Height: 52.8 mm 	1x M20 1x M25 1x Pg11	HC-STA-D07-HHFS-1STM20-EL-AL	1419235	1	
		HC-STA-D07-HHFS-1STM25-EL-AL	1419236	1	
		HC-STA-D07-HHFS-1STP11-EL-AL	1419237	1	
Protective cover, for housing sizes: Height: 30 mm 		D7, for female insert HC-STA-D07-HCLWS-PLR-BK	1419274	1	
		D7, for male insert HC-STA-D07-HCLWS-PL-BK	1419275	1	
Feed-through housing, with single locking latch Height: 60.5 mm 	1x M20	HC-STA-D07-CHPWS-1TGM20-EL-AL	1419242	1	
Protective cover, for coupling housings: Height: 29.4 mm 		D7, for female insert HC-STA-D07-BCLFS-PLR-BK	1419270	1	
		D7, for male insert HC-STA-D07-BCLFS-PL-BK	1419271	1	

Accessories



Cable glands
From page 686



Replacement sealing screws
From page 663



Replacement latches
phoenixcontact.net/products

Heavy-duty connectors

HEAVYCON D7 – housings

Size D7, plastic, supporting base elements with single locking latch







General data

Housing material	PA
Locking latch material	PA
Sealing material	NBR
IP degree of protection (when plugged in)	IP66
Ambient temperature (operation)	-40°C ... 125°C

Technical data



Ordering data

Description	Clamping area	Type	Order No.	Pcs./Pkt.	Dimensions
Panel mounting base Height: 25.5 mm 		Without cover	HC-STA-D07-BWS-PL-BK	1419265	1
		With cover, for female inserts	HC-STA-D07-BWSCF-PL-BK	1419277	1
		With cover, for male inserts	HC-STA-D07-BWSCM-PL-BK	1419278	1
Panel mounting base Height: 27.9 mm 		Angled version	HC-STA-D07-BAWS-PL-BK	1419266	1
Box mounting base Height: 27.9 mm 	4 mm ... 10 mm	open floor	HC-STA-D07-SHOWS-1SGM20-PL-BK	1419267	1
Box mounting base Height: 28 mm 	4 mm ... 10 mm	enclosed floor	HC-STA-D07-SHCWS-1SGM20-PL-BK	1419268	1
Coupling housing Height: 76 mm 	4 mm ... 10 mm 10 mm ... 16 mm	Without cover	HC-STA-D07-CHWS-1TGM20-PL-BK	1419259	1
			HC-STA-D07-CHWS-1TGM25-PL-BK	1419260	1
Coupling housing Height: 76 mm 	4 mm ... 10 mm 10 mm ... 16 mm	With cover, for female inserts	HC-STA-D07-CHWSCF-1TGM20-PL-BK	1419261	1
			HC-STA-D07-CHWSCF-1TGM25-PL-BK	1419262	1
		With cover, for male inserts	HC-STA-D07-CHWSCM-1TGM20-PL-BK	1419263	1
			HC-STA-D07-CHWSCM-1TGM25-PL-BK	1419264	1

Accessories



Protective covers
From page 654



Replacement sealing screws
From page 663



Replacement seals
phoenixcontact.net/products



Replacement latches
phoenixcontact.net/products









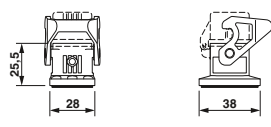

Size D7, metal, supporting base elements with single locking latch

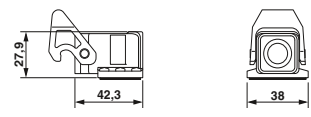

Technical data

General data	
Housing material	Die-cast aluminum, salt water resistant
Locking latch material	PA
Sealing material	NBR
IP degree of protection (when plugged in)	IP66 / IP67
Ambient temperature (operation)	-40°C ... 125°C

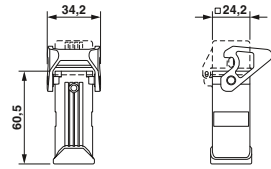
Ordering data

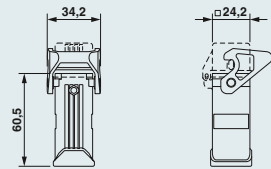
Description	Thread	Type	Order No.	Pcs./Pkt.	Dimensions	
Panel mounting base Height: 25.5 mm 		Without cover				
		HC-STA-D07-BWS-EL-AL	1419249	1		
		With cover, for female inserts				
		HC-STA-D07-BWSCF-EL-AL	1419251	1		
		With cover, for male inserts				
		HC-STA-D07-BWSCM-EL-AL	1419250	1		
Panel mounting base Height: 28.5 mm 		Angled version				
		HC-STA-D07-BAWS-EL-AL	1419252	1		
Box mounting base Height: 27.9 mm 	1x M20	open floor				
			HC-STA-D07-SHOWS-1STM20-EL-AL	1419253		1
		HC-STA-D07-SHOWS-1STP11-EL-AL	1419233	1		
Box mounting base Height: 27.9 mm 	1x M20	enclosed floor				
			HC-STA-D07-SHCWS-1STM20-EL-AL	1419234		1
		HC-STA-D07-SHCWS-1STP11-EL-AL	1419241	1		
Coupling housing Height: 60.5 mm 	1x M20 1x M25	Without cover				
		HC-STA-D07-CHWS-1TTM20-EL-AL	1419238	1		
		HC-STA-D07-CHWS-1TTM25-EL-AL	1419239	1		
		HC-STA-D07-CHWS-1TTP11-EL-AL	1419240	1		
Coupling housing Height: 60.5 mm 	1x M20 1x M25	With cover, for female inserts				
			HC-STA-D07-CHWSCF-1TTM20-EL-AL	1419243		1
			HC-STA-D07-CHWSCF-1TTM25-EL-AL	1419244		1
		HC-STA-D07-CHWSCF-1TTP11-EL-AL	1419245	1		
	1x M20 1x M25	With cover, for male inserts				
			HC-STA-D07-CHWSCM-1TTM20-EL-AL	1419246		1
		HC-STA-D07-CHWSCM-1TTM25-EL-AL	1419247	1		
		HC-STA-D07-CHWSCM-1TTP11-EL-AL	1419248	1		

Accessories



Protective covers
From page 654



Cable glands
From page 686



Replacement seals
phoenixcontact.net/products



Replacement latches
phoenixcontact.net/products

Heavy-duty connectors

HEAVYCON D – contact inserts

A10 series

250 V, 16 A ... 20 A

Connection technology:

- Push-in connection
- Screw connection
- Crimp connection

To determine the corresponding housing, see the system cross-reference list on page 502.

Notes:
For accessories, see from page 654
Order crimp contacts separately
Only operate connectors when there is no load/the power is switched off
¹⁾ For flexible wires with wire end protection



Type	Technical data		
	① HC-A 10-I-PT...	② HC-A 10-I-UT...	③ HC-A 10-E...C
Approvals	CE ENEC UL	CE ENEC UL	CE UL VDE ENEC
IEC data			
Rated current, contacts (at 40°C)	[A] 16	20	16
Overtoltage category	III	III	III
Degree of pollution	3	3	3
Rated voltage (III/3) contacts	[V] 250	250	250
Rated surge voltage, contacts	[kV] 4	4	4
Connection cross section	[mm ²] 0.14 ... 2.5 ¹⁾	0.5 ... 2.5	0.5 ... 4
UL data			
Rated voltage	[V] 600	600	600
Rated current	[A] 17	19	-
Connection cross section	AWG 14	14	-
CSA / cUL data			
Rated voltage	[V] 600	600	600
Rated current	[A] 14	15	10
Connection cross section	AWG 14	14	20-13
Material data			
Contact carrier material	PC	PC	PA
Inflammability class in acc. with UL 94	V0	V0	V0
Contact material	Copper alloy	Copper alloy	Copper alloy
Contact surface material	Ag	Ag	Ag (alternatively Au)
Temperature data			
Ambient temperature range	[°C] -40 ... 125	-40 ... 125	-40 ... 125
General data			
Connection method	Push-in connection	Screw connection	Crimp connection
Stripping length	[mm] 8	7	8
Number of positions	10	10	10
Contact numbering	1 - 10	1 - 10	1 - 10
Insertion/withdrawal cycles	≥ 500	≥ 500	≥ 500

Derating curves

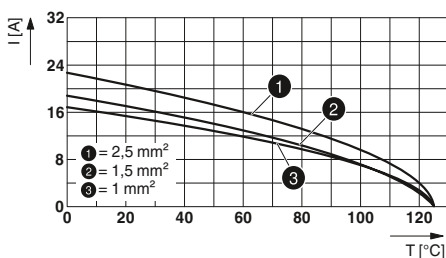

HC-A 10-I-PT...

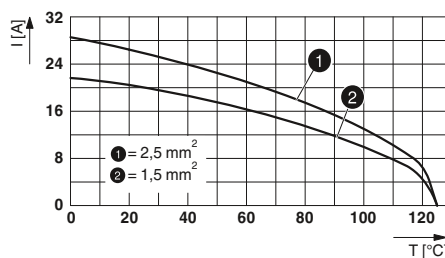

HC-A 10-I-UT...

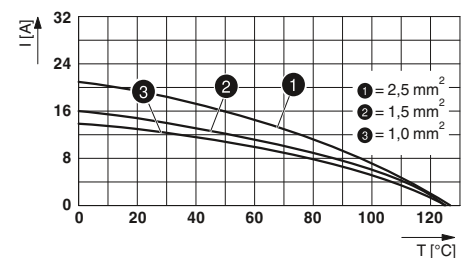

HC-A 10-E...C

Description	Pos.	Number	Size	Ordering data			
				Type	Order No. Female	Order No. Male	Pcs./ Pkt.
Push-in connection 	10	1 - 10	D15	① HC-A 10-I-PT...	1585362	1585359	1
Screw connection 	10	1 - 10	D15	② HC-A 10-I-UT...	1585304	1585294	1
Crimp connection CK 2,5 	10	1 - 10	D15	③ HC-A 10-E...C	1676983	1676996	10
Turned crimp contacts CK 2,5 Silver-plated 							
			Cross section mm ² / AWG				
			0.5 - 0.5 / 20	CK2,5-ED-0,50... AG	1663640	1663572	100
			0.75 - 0.75 / 18	CK2,5-ED-0,75... AG	1663653	1663585	100
			0.75 - 1 / 18	CK2,5-ED-1,00... AG	1663666	1663598	100
			1.5 - 1.5 / 16	CK2,5-ED-1,50... AG	1663679	1663608	100
			2.5 - 2.5 / 14	CK2,5-ED-2,50... AG	1663682	1663611	100
			4 - 4 / 12	CK2,5-ED-4,00... AG	1663705	1663637	100
Turned crimp contacts CK 2,5 Gold-plated 							
			Cross section mm ² / AWG				
			0.5 - 0.5 / 20	CK2,5-ED-0,50... AU	1674859	1674804	100
			0.75 - 1 / 18	CK2,5-ED-1,00... AU	1674833	1674781	100
			1.5 - 1.5 / 16	CK2,5-ED-1,50... AU	1674820	1674778	100
			2.5 - 2.5 / 14	CK2,5-ED-2,50... AU	1674862	1674817	100
			4 - 4 / 12	CK2,5-ED-4,00... AU	1674846	1674794	100

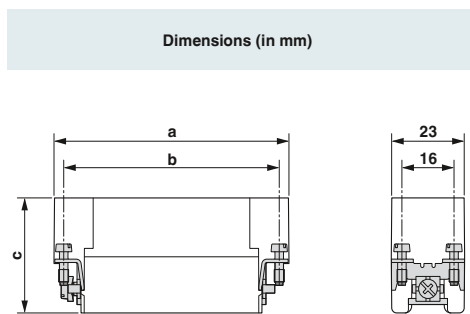

Dimensional drawing

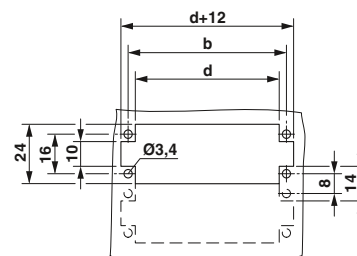

Panel cutout

	a	b	c	d
① Female	55.5	49.5	34.1	43.5
① Male				
② Female	55.5	49.5	31.5	43.5
② Male			34.1	
③ Female	56.5	49.5	30	43.5
③ Male			33	

Accessories



Crimping tools
From page 670



Coding profiles
From page 656



Coding elements
From page 657



Replacement PE screws
From page 662

Heavy-duty connectors

HEAVYCON D – contact inserts

A16 series

250 V, 16 A ... 20 A

Connection technology:

- Push-in connection
- Screw connection
- Crimp connection

To determine the corresponding housing, see the system cross-reference list on page 502.

Notes:
For accessories, see from page 654
Order crimp contacts separately
Only operate connectors when there is no load/the power is switched off
¹⁾ For flexible wires with wire end protection



Type	Technical data		
	① ② HC-A 16-I-PT...	③ ④ HC-A 16-I-UT...	⑤ ⑥ HC-A 16-E...C
Approvals	CE ENEC UL	CE ENEC UL	CE UL VDE
IEC data			
Rated current, contacts (at 40°C)	[A] 16	20	16
Overtoltage category	III	III	III
Degree of pollution	3	3	3
Rated voltage (III/3) contacts	[V] 250	250	250
Rated surge voltage, contacts	[kV] 4	4	4
Connection cross section	[mm ²] 0.14 ... 2.5 ¹⁾	0.5 ... 2.5	0.5 ... 4
UL data			
Rated voltage	[V] 600	600	600
Rated current	[A] 16	19	-
Connection cross section	AWG 14	14	-
CSA / cUL data			
Rated voltage	[V] 600	600	600
Rated current	[A] 13	15	10
Connection cross section	AWG 14	14	20-13
Material data			
Contact carrier material	PC	PC	PA
Inflammability class in acc. with UL 94	V0	V0	V0
Contact material	Copper alloy	Copper alloy	Copper alloy
Contact surface material	Ag	Ag	Ag (alternatively Au)
Temperature data			
Ambient temperature range	[°C] -40 ... 125	-40 ... 125	-40 ... 125
General data			
Connection method	Push-in connection	Screw connection	Crimp connection
Stripping length	[mm] 8	7	8
Number of positions	16	16	16
Contact numbering	1 - 16	1 - 16	1 - 16
Insertion/withdrawal cycles	≥ 500	≥ 500	≥ 500

Derating curves

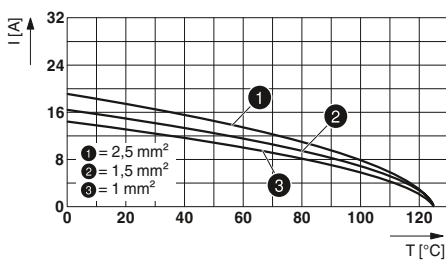

HC-A 16-I-PT...

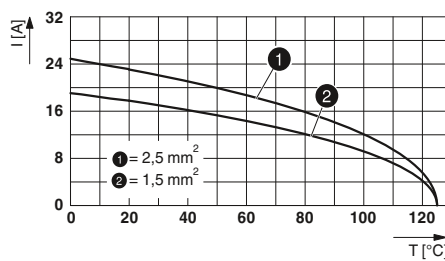

HC-A 16-I-UT...

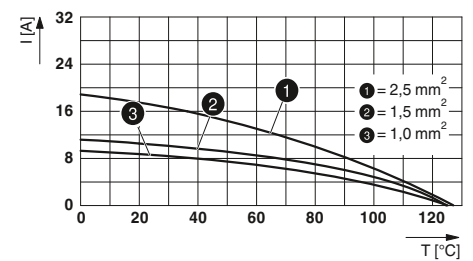

HC-A 16-E...C

Description	Pos.	Number	Size	Type	Ordering data		Pcs./Pkt.
					Female	Male	
Push-in connection							
	16	1 - 16	D25 / D50	① HC-A 16-I-PT-...	1585388	1585375	1
	16	17 - 32	D25 / D50	② HC-A 16-I-PT-...-32	1585401	1585391	1
Screw connection							
	16	1 - 16	D25 / D50	③ HC-A 16-I-UT-...	1585320	1585317	1
	16	17 - 32	D25 / D50	④ HC-A 16-I-UT-...-32	1585346	1585333	1
Crimp connection CK 2,5							
	16	1 - 16	D25 / D50	⑤ HC-A 16-E...C	1677018	1677034	10
	16	17 - 32	D25 / D50	⑥ HC-A 16-E...C-32	1677050	1677076	10
Turned crimp contacts CK 2,5 Silver-plated							
	Cross section mm ² / AWG			CK2,5-ED-0,50... AG	1663640	1663572	100
	0.5 - 0.5 / 20			CK2,5-ED-0,75... AG	1663653	1663585	100
	0.75 - 0.75 / 18			CK2,5-ED-1,00... AG	1663666	1663598	100
	0.75 - 1 / 18			CK2,5-ED-1,50... AG	1663679	1663608	100
	1.5 - 1.5 / 16			CK2,5-ED-2,50... AG	1663682	1663611	100
	2.5 - 2.5 / 14			CK2,5-ED-4,00... AG	1663705	1663637	100
	4 - 4 / 12						
Turned crimp contacts CK 2,5 Gold-plated							
	Cross section mm ² / AWG			CK2,5-ED-0,50... AU	1674859	1674804	100
	0.5 - 0.5 / 20			CK2,5-ED-1,00... AU	1674833	1674781	100
	0.75 - 1 / 18			CK2,5-ED-1,50... AU	1674820	1674778	100
	1.5 - 1.5 / 16			CK2,5-ED-2,50... AU	1674862	1674817	100
	2.5 - 2.5 / 14			CK2,5-ED-4,00... AU	1674846	1674794	100
	4 - 4 / 12						

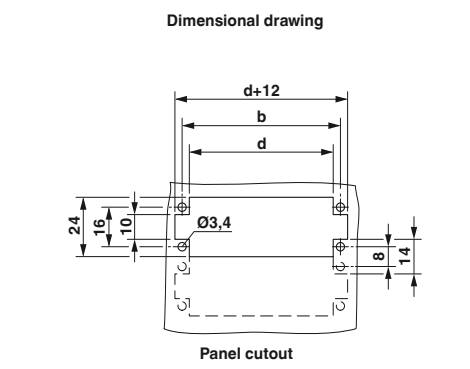
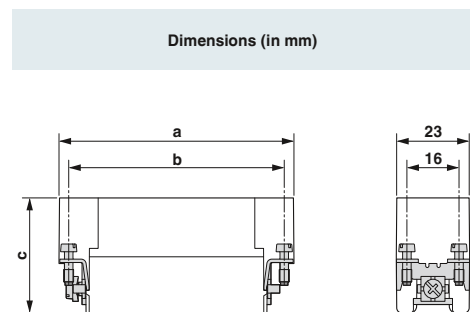

	a	b	c	d
① Female	72	66	31.5	60
① Male	72	66	34.1	60
② Female	72	66	31.5	60
② Male	72	66	34.1	60
③ Female	72	66	31.5	60
③ Male	72	66	34.1	60
④ Female	72	66	31.5	60
④ Male	72	66	34.1	60
⑤ Female	72	66	31.7	60
⑤ Male	72	66	31.8	60
⑥ Female	72	66	31.7	60
⑥ Male	72	66	31.8	60

Accessories

			
Crimping tools From page 670	Coding profiles From page 656	Coding elements From page 657	Replacement PE screws From page 662

Heavy-duty connectors

HEAVYCON D – contact inserts

D15, D25 series

250 V, 10 A

Connection technology:

– Crimp connection

Guide pins and sockets are mandatory for HC-D... and HC-DD series contact inserts; see page 657.

To determine the corresponding housing, see the system cross-reference list on page 502.

Notes:
For accessories, see from page 654
Order crimp contacts separately
Only operate connectors when there is no load/the power is switched off



Type	Technical data		
	① HC-D 15-I-CT...	② ③ HC-D 25-I-CT...	④ HC-D 25-I-CT...-Z
Approvals	UL ENEC VDE	UL ENEC VDE	UL ENEC VDE Euromap
IEC data			
Rated current, contacts (at 40°C)	10 [A]	10	10
Overvoltage category	III	III	III
Degree of pollution	3	3	3
Rated voltage (III/3) contacts	250 [V]	250	250
Rated surge voltage, contacts	4 [kV]	4	4
Connection cross section	0.14 ... 2.5 [mm²]	0.14 ... 2.5	0.14 ... 2.5
UL data			
Rated voltage	600 [V]	600	600
Rated current	10 [A]	10	10
Connection cross section	14 AWG	14	14
CSA / cUL data			
Rated voltage	600 [V]	600	600
Rated current	8 [A]	8	8
Connection cross section	14 AWG	14	14
Material data			
Contact carrier material	PC	PC	PA
Inflammability class in acc. with UL 94	V0	V0	V0
Contact material	Copper alloy	Copper alloy	Copper alloy
Contact surface material	Ag (alternatively Au)	Ag (alternatively Au)	Ag (alternatively Au)
Temperature data			
Ambient temperature range	-40 ... 125 [°C]	-40 ... 125	-40 ... 125
General data			
Connection method	Crimp connection	Crimp connection	Crimp connection
Stripping length	8 [mm]	8	8
Number of positions	15	25	25
Contact numbering	-	-	-
Insertion/withdrawal cycles	≥ 500	≥ 500	≥ 500

Derating curves

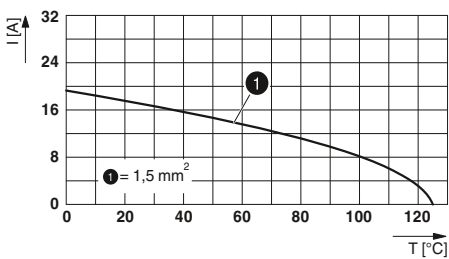

HC-D 15-I-CT....

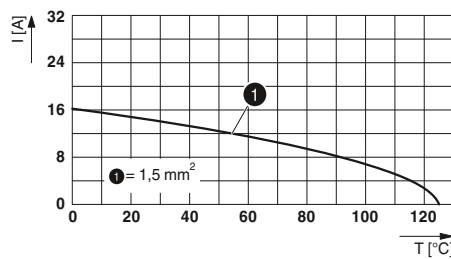

HC-D 25-I-CT...

				Ordering data			Dimensions (in mm)																																																	
Description	Pos.	Number	Size	Type	Order No.		Pcs./Pkt.																																																	
					Female	Male																																																		
Crimp connection CK 1,6 	15		D15	① HC-D 15-I-CT-...	1584389	1584376	1	<p>Dimensional drawing</p> <p>Panel cutout</p>																																																
Crimp connection CK 1,6 	25		D25 / D50	② HC-D 25-I-CT-...	1584402	1584392	1																																																	
	25		D25 / D50	③ HC-D 25-I-CT-...	1584402	1584392	1																																																	
Crimp connection CK 1,6 	25		D25 / D50	Euromap ④ HC-D 25-I-CT-...-Z	1411481	1411478	1																																																	
								<table border="1"> <thead> <tr> <th></th> <th>a</th> <th>b</th> <th>c</th> <th>d</th> </tr> </thead> <tbody> <tr> <td>① Female</td> <td>55.4</td> <td>49.5</td> <td>33.5</td> <td>43.5</td> </tr> <tr> <td>① Male</td> <td></td> <td></td> <td>34.2</td> <td></td> </tr> <tr> <td>② Female</td> <td>72</td> <td>66</td> <td>33.5</td> <td>60</td> </tr> <tr> <td>② Male</td> <td></td> <td></td> <td>34.2</td> <td></td> </tr> <tr> <td>③ Female</td> <td>72</td> <td>66</td> <td>33.5</td> <td>60</td> </tr> <tr> <td>③ Male</td> <td></td> <td></td> <td>34.2</td> <td></td> </tr> <tr> <td>④ Female</td> <td>72</td> <td>66</td> <td>33.5</td> <td>60</td> </tr> <tr> <td>④ Male</td> <td></td> <td></td> <td>34.2</td> <td></td> </tr> </tbody> </table>					a	b	c	d	① Female	55.4	49.5	33.5	43.5	① Male			34.2		② Female	72	66	33.5	60	② Male			34.2		③ Female	72	66	33.5	60	③ Male			34.2		④ Female	72	66	33.5	60	④ Male			34.2	
	a	b	c	d																																																				
① Female	55.4	49.5	33.5	43.5																																																				
① Male			34.2																																																					
② Female	72	66	33.5	60																																																				
② Male			34.2																																																					
③ Female	72	66	33.5	60																																																				
③ Male			34.2																																																					
④ Female	72	66	33.5	60																																																				
④ Male			34.2																																																					
Turned crimp contacts CK 1,6 Silver-plated 			Cross section mm ² / AWG 0.14 - 0.37 / 26 - 22 0.5 - 0.5 / 20 0.75 - 0.75 / 18 0.75 - 1 / 18 1.5 - 1.5 / 16 2.5 - 2.5 / 14	CK1,6-ED-0,37... AG CK1,6-ED-0,50... AG CK1,6-ED-0,75... AG CK1,6-ED-1,00... AG CK1,6-ED-1,50... AG CK1,6-ED-2,50... AG	1663394 1663404 1663417 1663420 1663433 1663446	1663336 1663349 1663352 1663365 1663378 1663381	100 100 100 100 100 100																																																	
Turned crimp contacts CK 1,6 Gold-plated 			Cross section mm ² / AWG 0.14 - 0.37 / 24 - 22 0.5 - 0.5 / 20 0.75 - 0.75 / 18 0.75 - 1 / 18 1.5 - 1.5 / 16 2.5 - 2.5 / 14	CK1,6-ED-0,37... AU CK1,6-ED-0,50... AU CK1,6-ED-0,75... AU CK1,6-ED-1,00... AU CK1,6-ED-1,50... AU CK1,6-ED-2,50... AU	1674969 1674480 1672440 1674943 1674930 1674985	1674901 1672453 1674914 1674888 1674875 1674927	100 100 100 100 100 100																																																	

Accessories



Crimping tools
From page 670



Guide elements
From page 657



Replacement PE screws
From page 662

Heavy-duty connectors

HEAVYCON D – housings

Size D15, plastic, EVO sleeve housings for single locking latch



General data

Housing material	PA
Locking latch material	-
Sealing material	NBR
IP degree of protection (when plugged in)	IP66
NEMA degree of protection (when plugged in)	12
Ambient temperature (operation)	-40°C ... 125°C

Technical data

Ordering data

Description

Thread

Type

Order No.

Pcs./Pkt.

Dimensions

Sleeve housing Height: 65.5 mm



HC-EVO-D15-HHFS-PL-BK

1411340

1

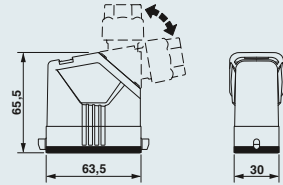

Sleeve housing Height: 65.5 mm



HC-EVO-D15-HHFS-PL-BK

1411340

1

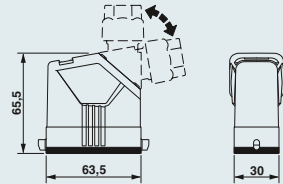

Cable gland

Clamping area
7 mm ... 13 mm
9 mm ... 17 mm



HC-D-G-M20-PLRBK
HC-D-G-M25-PLRBK

1411350
1411351

1
1

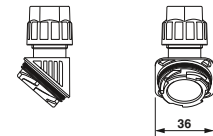

Connector set¹⁾ Height: 100.5 mm



Without cover, Push-in connection
HC-EVO-A10PT-BWS-HH-M20-PLRBK 1424453 1
Without cover, screw connection
HC-EVO-A10UT-BWS-HH-M20-PLRBK 1411356 1
With cover, Push-in connection
HC-EVO-A10PT-BWSC-HH-M20-PLRBK 1424454 1
With cover, screw connection
HC-EVO-A10UT-BWSC-HH-M20-PLRBK 1411357 1

Notes:

Marking label: US-EMP (20X9) Order No. 0829439

¹⁾ Connector sets: phoenixcontact.net/webcode/#0523

Accessories



EVO unlocking tools
From page 659



Thread adapters
From page 658









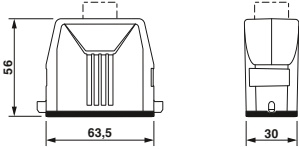

Module carrier frames
phoenixcontact.net/products

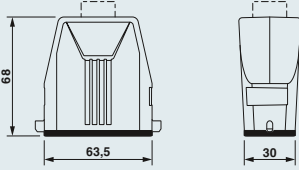
Size D15, metal, STANDARD sleeve housings for single locking latch

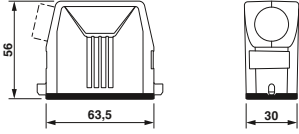

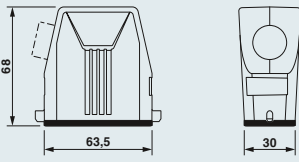
General data		Technical data	
Housing material		Die-cast aluminum, salt water resistant	
Locking latch material		-	
Sealing material		NBR, conductive	
IP degree of protection (when plugged in)		IP66 / IP67	
NEMA degree of protection (when plugged in)		-	
Ambient temperature (operation)		-40°C ... 125°C	

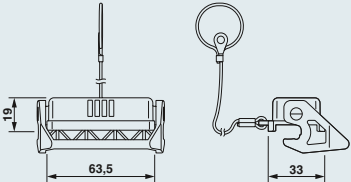
Description		Thread	Type	Order No.	Pcs./Pkt.	Dimensions
Sleeve housing Height: 56 mm 	1x M20	1x Pg13.5	HC-STA-D15-HLFS-1TTM20-ELC-AL	1424350	1	
			HC-STA-D15-HLFS-1TTP13-ELC-AL	1424352	1	
Sleeve housing Height: 68 mm 	1x M25	1x Pg16 1x Pg21	HC-STA-D15-HHFS-1TTM25-ELC-AL	1424351	1	
			HC-STA-D15-HHFS-1TTP16-ELC-AL	1424353	1	
			HC-STA-D15-HHFS-1TTP21-ELC-AL	1424358	1	
Sleeve housing Height: 56 mm 	1x M20	1x Pg16	HC-STA-D15-HLFS-1STM20-ELC-AL	1424345	1	
			HC-STA-D15-HLFS-1STP16-ELC-AL	1424347	1	
Sleeve housing Height: 68 mm 	1x M25	1x Pg16 1x Pg21	HC-STA-D15-HHFS-1STM25-ELC-AL	1424346	1	
			HC-STA-D15-HHFS-1STP16-ELC-AL	1424348	1	
			HC-STA-D15-HHFS-1STP21-ELC-AL	1424349	1	
Protective cover Height: 19 mm 			HC-STA-D15-HCLWS-PL-BK	1424375	1	

Notes:
Marking label: US-EMLP-HA (20X9), Order No. 0830989

Accessories



Cable glands
From page 686



Cover plates
From page 664



D-SUB adapter plates
From page 665



Module carrier frames
phoenixcontact.net/products

Heavy-duty connectors

HEAVYCON D – housings

Size D15, plastic, EVO supporting base elements with single locking latch











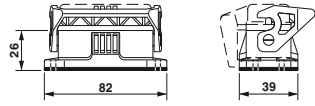

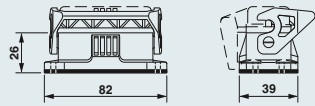
General data

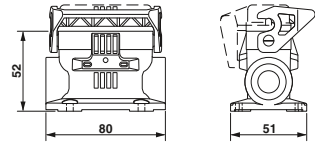
Housing material	PA
Locking latch material	PA
Sealing material	NBR
IP degree of protection (when plugged in)	IP66
NEMA degree of protection (when plugged in)	12
Ambient temperature (operation)	-40°C ... 125°C

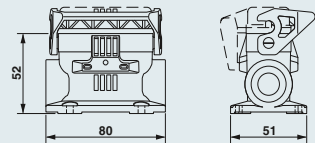
Technical data

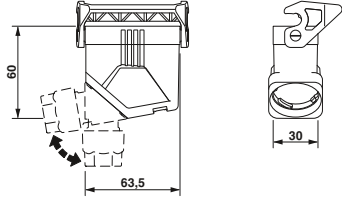
Ordering data

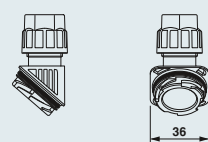
Description	Thread	Type	Order No.	Pcs./Pkt.	Dimensions
Panel mounting base Height: 26 mm 		Without cover HC-EVO-D15-BWS-PLR-BK	1411336	1	
Panel mounting base Height: 26 mm 		With cover HC-EVO-D15-BWSC-PLR-BK	1411337	1	
Box mounting base¹⁾ Height: 52 mm 	2x M20 2x M25	Without cover HC-EVO-D15-SLWS-2SSM20-PLR-BK HC-EVO-D15-SLWS-2SSM25-PLR-BK	1421463 1411341	1 1	
Box mounting base¹⁾ Height: 52 mm 	2x M20 2x M25	With cover HC-EVO-D15-SLWSC-2SSM20-PLR-BK HC-EVO-D15-SLWSC-2SSM25-PLR-BK	1421465 1411343	1 1	
Coupling housing Height: 60 mm 		HC-EVO-D15-CHWS-PL-BK	1411338	1	
Cable gland 	Clamping area 7 mm ... 13 mm 9 mm ... 17 mm	HC-D-G-M20-PLRBK HC-D-G-M25-PLRBK	1411350 1411351	1 1	

Notes:

¹⁾ One cable entry is sealed with a knockout cover

Accessories



EVO unlocking tools
From page 659



Thread adapters
From page 658



Replacement protective covers
phoenixcontact.net/products



Replacement latches
phoenixcontact.net/products

Size D15, metal, STANDARD supporting base elements with single locking latch











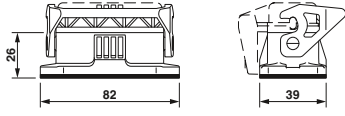

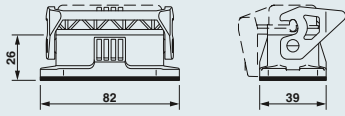
General data	
Housing material	Die-cast aluminum, salt water resistant
Locking latch material	PA
Sealing material	NBR, conductive
IP degree of protection (when plugged in)	IP66 / IP67
NEMA degree of protection (when plugged in)	-
Ambient temperature (operation)	-40°C ... 125°C

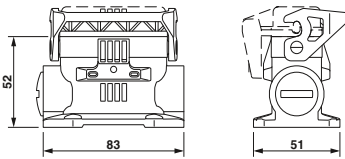
Technical data	
Housing material	Die-cast aluminum, salt water resistant
Locking latch material	PA
Sealing material	NBR, conductive
IP degree of protection (when plugged in)	IP66 / IP67
NEMA degree of protection (when plugged in)	-
Ambient temperature (operation)	-40°C ... 125°C

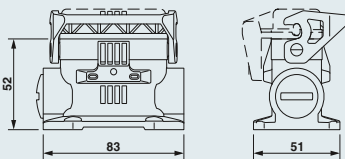

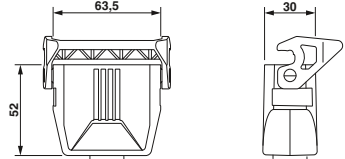

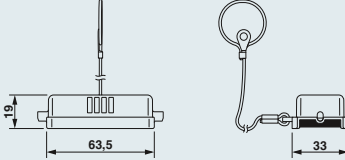
Ordering data	
---------------	--

Ordering data	
---------------	--

Description	Thread	Type	Order No.	Pcs./Pkt.	Dimensions
Panel mounting base Height: 26 mm 		Without cover HC-STA-D15-BWS-EL-AL	1424362	1	
Panel mounting base Height: 26 mm 		With cover HC-STA-D15-BWSC-EL-AL	1424363	1	
Box mounting base¹⁾ Height: 52 mm 	2x M20 2x M25 2x Pg16 2x Pg21	Without cover HC-STA-D15-SLWS-2SSM20-EL-AL HC-STA-D15-SLWS-2SSM25-EL-AL HC-STA-D15-SLWS-2SSP16-EL-AL HC-STA-D15-SLWS-2SSP21-EL-AL	1424364 1424365 1424366 1424367	1 1 1 1	
Box mounting base¹⁾ Height: 52 mm 	2x M20 2x M25 2x Pg16 2x Pg21	With cover HC-STA-D15-SLWSC-2SSM20-EL-AL HC-STA-D15-SLWSC-2SSM25-EL-AL HC-STA-D15-SLWSC-2SSP16-EL-AL HC-STA-D15-SLWSC-2SSP21-EL-AL	1424369 1424371 1424372 1424373	1 1 1 1	
Coupling housing Height: 52 mm 	1x M20 1x M25 1x Pg16	HC-STA-D15-CLWS-1TTM20-EL-AL HC-STA-D15-CHWS-1TTM25-EL-AL HC-STA-D15-CHWS-1TTP16-EL-AL	1424359 1424361 1424360	1 1 1	
Protective cover Height: 19 mm 		HC-STA-D15-BCSFS-PLR-BK	1424374	1	

Notes:
¹⁾ Supplied with a plastic sealing cap

Accessories

 Cable glands From page 686	 Replacement latches phoenixcontact.net/products	 Replacement seals phoenixcontact.net/products	 Module carrier frames phoenixcontact.net/products
---	---	---	---

Heavy-duty connectors

HEAVYCON D – housings

Size D25, plastic, EVO sleeve housings for single locking latch



General data

Housing material	PA
Locking latch material	-
Sealing material	NBR
IP degree of protection (when plugged in)	IP66
NEMA degree of protection (when plugged in)	12
Ambient temperature (operation)	-40°C ... 125°C

Technical data

Ordering data

Description

Thread

Type

Order No.

Pcs./Pkt.

Dimensions

Sleeve housing Height: 75.5 mm



HC-EVO-D25-HHFS-PL-BK

1411347

1

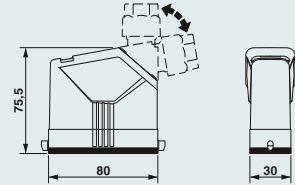

Sleeve housing Height: 75.5 mm



HC-EVO-D25-HHFS-PL-BK

1411347

1

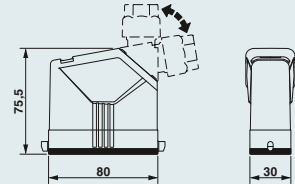

Cable gland

Clamping area
7 mm ... 13 mm
9 mm ... 17 mm



HC-D-G-M20-PLRBK
HC-D-G-M25-PLRBK

1411350
1411351

1
1

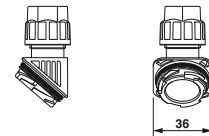

Connector set¹⁾ Height: 114.5 mm



Without cover, Push-in connection
HC-EVO-A16PT-BWS-HH-M25-PLRBK 1424459 1
Without cover, screw connection
HC-EVO-A16UT-BWS-HH-M25-PLRBK 1411358 1
With cover, Push-in connection
HC-EVO-A16PT-BWSC-HH-M25-PLRBK 1424460 1
With cover, screw connection
HC-EVO-A16UT-BWSC-HH-M25-PLRBK 1411359 1

Notes:

Marking label: US-EMP (20X9) Order No. 0829439

¹⁾ Connector sets: phoenixcontact.net/webcode/#0523

Accessories



EVO unlocking tools
From page 659









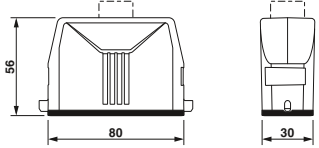

Thread adapters
From page 658

Size D25, metal, STANDARD sleeve housings for single locking latch

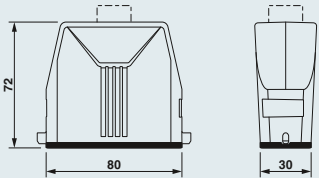

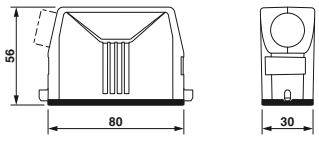
General data		Technical data	
Housing material		Die-cast aluminum, salt water resistant	
Locking latch material		-	
Sealing material		NBR, conductive	
IP degree of protection (when plugged in)		IP66 / IP67	
NEMA degree of protection (when plugged in)		-	
Ambient temperature (operation)		-40°C ... 125°C	

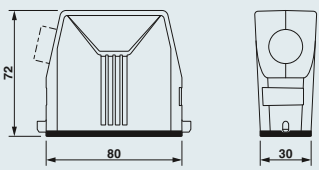
Ordering data

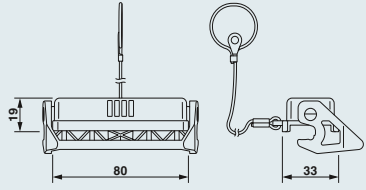
Description	Thread	Type	Order No.	Pcs./Pkt.	Dimensions
Sleeve housing Height: 56 mm 	1x M20 1x Pg16	HC-STA-D25-HLFS-1TTM20-ELC-AL	1424381	1	
		HC-STA-D25-HLFS-1TTP16-ELC-AL	1424383	1	
Sleeve housing Height: 72 mm 	1x M25 1x Pg16 1x Pg21	HC-STA-D25-HHFS-1TTM25-ELC-AL	1424382	1	
		HC-STA-D25-HHFS-1TTP16-ELC-AL	1424384	1	
		HC-STA-D25-HHFS-1TTP21-ELC-AL	1424385	1	
Sleeve housing Height: 56 mm 	1x M20 1x Pg16	HC-STA-D25-HLFS-1STM20-ELC-AL	1424376	1	
		HC-STA-D25-HLFS-1STP16-ELC-AL	1424378	1	
Sleeve housing Height: 72 mm 	1x M25 1x Pg16 1x Pg21	HC-STA-D25-HHFS-1STM25-ELC-AL	1424377	1	
		HC-STA-D25-HHFS-1STP16-ELC-AL	1424379	1	
		HC-STA-D25-HHFS-1STP21-ELC-AL	1424380	1	
Protective cover Height: 19 mm 		HC-STA-D25-HCLWS-PL-BK	1424400	1	

Notes:
Marking label: US-EMLP-HA (20X9), Order No. 0830989

Accessories



Cable glands
From page 686

Cover plates
From page 664

D-SUB adapter plates
From page 665

Heavy-duty connectors

HEAVYCON D – housings

Size D25, plastic, EVO supporting base elements with single locking latch









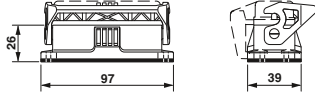

General data

Housing material	PA
Locking latch material	PA
Sealing material	NBR
IP degree of protection (when plugged in)	IP66
NEMA degree of protection (when plugged in)	12
Ambient temperature (operation)	-40°C ... 125°C

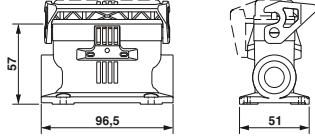
Technical data

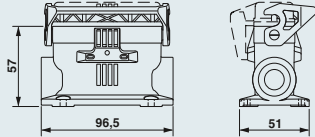

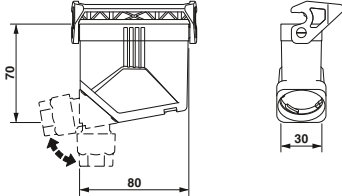
Ordering data

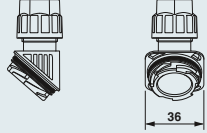
Description	Thread	Type	Order No.	Pcs./Pkt.	Dimensions
Panel mounting base Height: 26 mm 		Without cover HC-EVO-D25-BWS-PLR-BK	1411344	1	
Panel mounting base Height: 26 mm 		With cover HC-EVO-D25-BWSC-PLR-BK	1411345	1	
Box mounting base¹⁾ Height: 57 mm 	2x M20 2x M25	Without cover HC-EVO-D25-SLWS-2SSM20-PLR-BK HC-EVO-D25-SLWS-2SSM25-PLR-BK	1421466 1411348	1 1	
Box mounting base¹⁾ Height: 57 mm 	2x M20 2x M25	With cover HC-EVO-D25-SLWSC-2SSM20-PLR-BK HC-EVO-D25-SLWSC-2SSM25-PLR-BK	1421467 1411349	1 1	
Coupling housing Height: 70 mm 		HC-EVO-D25-CHWS-PLR-BK	1411346	1	
Cable gland 	Clamping area 7 mm ... 13 mm 9 mm ... 17 mm	HC-D-G-M20-PLRBK HC-D-G-M25-PLRBK	1411350 1411351	1 1	

Notes:

¹⁾ One cable entry is sealed with a knockout cover

Accessories



EVO unlocking tools
From page 659



Thread adapters
From page 658



Replacement protective covers
phoenixcontact.net/products



Replacement latches
phoenixcontact.net/products

Size D25, metal, STANDARD supporting base elements with single locking latch











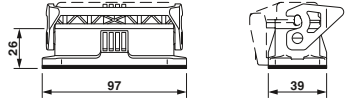

General data

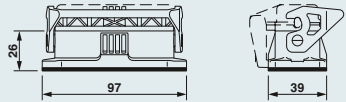
Housing material
Locking latch material
Sealing material
IP degree of protection (when plugged in)
NEMA degree of protection (when plugged in)
Ambient temperature (operation)

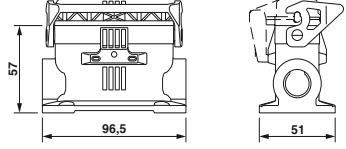
Technical data

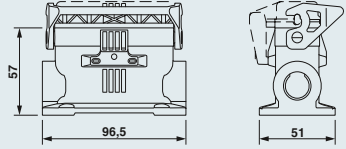
Die-cast aluminum, salt water resistant
PA
NBR, conductive
IP66 / IP67
-
-40°C ... 125°C

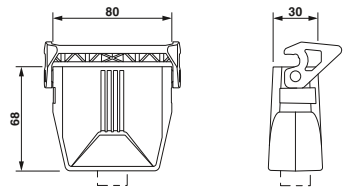
Ordering data

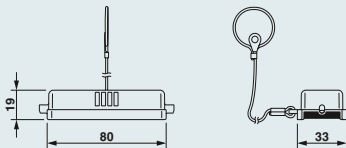
Description	Thread	Type	Order No.	Pcs./Pkt.	Dimensions
Panel mounting base Height: 26 mm 		Without cover HC-STA-D25-BWS-EL-AL	1424391	1	
Panel mounting base Height: 26 mm 		With cover HC-STA-D25-BWSC-EL-AL	1424390	1	
Box mounting base¹⁾ Height: 57 mm 	2x M20 2x M25 2x Pg16 2x Pg21	Without cover HC-STA-D25-SLWS-2SSM20-EL-AL HC-STA-D25-SLWS-2SSM25-EL-AL HC-STA-D25-SLWS-2SSP16-EL-AL HC-STA-D25-SLWS-2SSP21-EL-AL	1424392 1424393 1424394 1424395	1 1 1 1	
Box mounting base¹⁾ Height: 57 mm 	2x M20 2x M25 2x Pg16 2x Pg21	With cover HC-STA-D25-SLWSC-2SSM20-EL-AL HC-STA-D25-SLWSC-2SSM25-EL-AL HC-STA-D25-SLWSC-2SSP16-EL-AL HC-STA-D25-SLWSC-2SSP21-EL-AL	1424396 1424397 1424398 1424399	1 1 1 1	
Coupling housing Height: 68 mm 	1x M25 1x Pg16	HC-STA-D25-CHWS-1TTM25-EL-AL HC-STA-D25-CHWS-1TTP16-EL-AL	1424387 1424389	1 1	
Protective cover Height: 19 mm 		HC-STA-D25-BCSFS-PLR-BK	1424401	1	

Notes:

¹⁾ Supplied with a plastic sealing cap

Accessories



Cable glands
From page 686



Replacement latches
phoenixcontact.net/products



Replacement seals
phoenixcontact.net/products



D-SUB adapter plates
From page 665

Heavy-duty connectors

HEAVYCON D – housings

Size D50, metal, STANDARD sleeve housings for double locking latch







General data

Housing material
Locking latch material
Sealing material
IP degree of protection (when plugged in)
NEMA degree of protection (when plugged in)
Ambient temperature (operation)

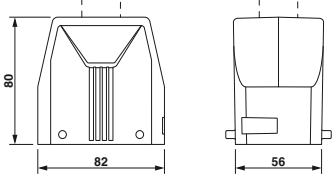
Technical data	
Housing material	Die-cast aluminum, salt water resistant
Locking latch material	-
Sealing material	-
IP degree of protection (when plugged in)	IP66 / IP67
NEMA degree of protection (when plugged in)	-
Ambient temperature (operation)	-40°C ... 125°C

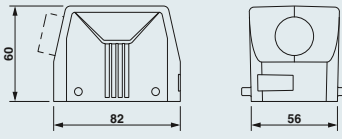
Ordering data

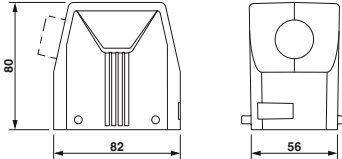
Description	Thread	Type	Order No.	Pcs./Pkt.	Dimensions
Sleeve housing Height: 80 mm 	1x M25 1x M32 1x Pg21 1x Pg29	Cable outlet: top			
		HC-STA-D50-HHFD-1TTM25-EL-AL	1424408	1	
		HC-STA-D50-HHFD-1TTM32-EL-AL	1424409	1	
		HC-STA-D50-HHFD-1TTP21-EL-AL	1424410	1	
		HC-STA-D50-HHFD-1TTP29-EL-AL	1424411	1	
Sleeve housing Height: 60 mm 	1x M25 1x Pg21	Cable outlet: lateral			
		HC-STA-D50-HLFD-1STM25-EL-AL	1424402	1	
		HC-STA-D50-HLFD-1STP21-EL-AL	1424405	1	
Sleeve housing Height: 80 mm 	1x M25 1x M32 1x Pg21 1x Pg29	Cable outlet: lateral			
		HC-STA-D50-HHFD-1STM25-EL-AL	1424403	1	
		HC-STA-D50-HHFD-1STM32-EL-AL	1424404	1	
		HC-STA-D50-HHFD-1STP21-EL-AL	1424406	1	
		HC-STA-D50-HHFD-1STP29-EL-AL	1424407	1	

Notes:
Marking label: US-EMLP-HA (20X9), Order No. 0830989

Accessories



Cable glands
From page 686







Replacement seals
phoenixcontact.net/products

Size D50, metal, STANDARD supporting base elements with double locking latch

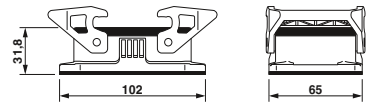

General data	
Housing material	Die-cast aluminum, salt water resistant
Locking latch material	PA
Sealing material	NBR, conductive
IP degree of protection (when plugged in)	IP66 / IP67
NEMA degree of protection (when plugged in)	-
Ambient temperature (operation)	-40°C ... 125°C

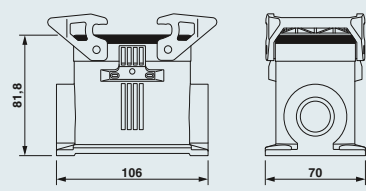
Ordering data

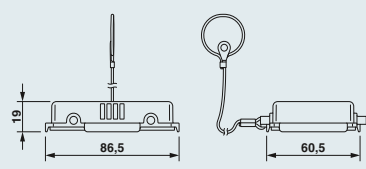
Description	Thread	Type	Order No.	Pcs./Pkt.	Dimensions
Panel mounting base Height: 32 mm 		Without cover HC-STA-D50-BWD-ELC-AL	1424412	1	
Box mounting base¹⁾ Height: 82 mm 	2x M25 2x M32 2x Pg21 2x Pg29	Without cover HC-STA-D50-SHWD-2SSM25-ELC-AL HC-STA-D50-SHWD-2SSM32-ELC-AL HC-STA-D50-SHWD-2SSP21-ELC-AL HC-STA-D50-SHWD-2SSP29-ELC-AL	1424413 1424414 1424415 1424416	1 1 1 1	
Protective cover Height: 19 mm 		HC-STA-D50-BCSFD-PL-BK	1424417	1	

Notes:
¹⁾ Supplied with a plastic sealing cap

Accessories



Cable glands
 From page 686

Heavy-duty connectors

HEAVYCON B – contact inserts

D40, D64 series

250 V, 10 A

Connection technology:

– Crimp connection

Guide pins and sockets are mandatory for HC-D... and HC-DD series contact inserts; see page 657.

To determine the corresponding housing, see the system cross-reference list on page 502.

Notes:
For accessories, see from page 654
Order crimp contacts separately
Only operate connectors when there is no load/the power is switched off



Type	Technical data			
	① HC-D 40-I-CT...		② HC-D 64-I-CT...	
Approvals	UL ENEC VDE		UL ENEC VDE	
IEC data				
Rated current, contacts (at 40°C)	[A]	10	10	
Overvoltage category		III	III	
Degree of pollution		3	3	
Rated voltage (III/3) contacts	[V]	250	250	
Rated surge voltage, contacts	[kV]	4	4	
Connection cross section	[mm ²]	0.14 ... 2.5	0.14 ... 2.5	
UL data				
Rated voltage	[V]	600	600	
Rated current	[A]	10	10	
Connection cross section	AWG	14	14	
CSA / cUL data				
Rated voltage	[V]	600	600	
Rated current	[A]	7	7	
Connection cross section	AWG	14	14	
Material data				
Contact carrier material		PC	PC	
Inflammability class in acc. with UL 94		V0	V0	
Contact material		Copper alloy	Copper alloy	
Contact surface material		Ag (alternatively Au)	Ag (alternatively Au)	
Temperature data				
Ambient temperature range	[°C]	-40 ... 125	-40 ... 125	
General data				
Connection method		Crimp connection	Crimp connection	
Stripping length	[mm]	8	8	
Number of positions		40	64	
Contact numbering		-	-	
Insertion/withdrawal cycles		≥ 500	≥ 500	



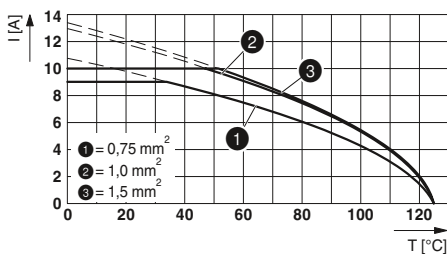

Derating curves

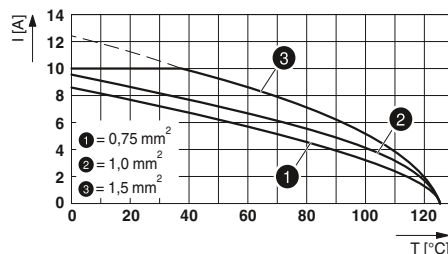

HC-D 40-I-CT...



HC-D 64-I-CT...

Description	Pos.	Number	Size	Ordering data			
				Type	Order No. Female	Order No. Male	Pcs./ Pkt.
Crimp connection							
	40	B16 / B32	① HC-D 40-I-CT...	1584428	1584415	1	
Crimp connection							
	64	B24 / B48	② HC-D 64-I-CT...	1584444	1584431	1	
Turned crimp contacts CK 1,6 Silver-plated							
		Cross section mm² / AWG					
		0.14 - 0.37 / 26 - 22	CK1,6-ED-0,37... AG	1663394	1663336	100	
		0.5 - 0.5 / 20	CK1,6-ED-0,50... AG	1663404	1663349	100	
		0.75 - 0.75 / 18	CK1,6-ED-0,75... AG	1663417	1663352	100	
		0.75 - 1 / 18	CK1,6-ED-1,00... AG	1663420	1663365	100	
		1.5 - 1.5 / 16	CK1,6-ED-1,50... AG	1663433	1663378	100	
		2.5 - 2.5 / 14	CK1,6-ED-2,50... AG	1663446	1663381	100	
Turned crimp contacts CK 1,6 Gold-plated							
		Cross section mm² / AWG					
		0.14 - 0.37 / 24 - 22	CK1,6-ED-0,37... AU	1674969	1674901	100	
		0.5 - 0.5 / 20	CK1,6-ED-0,50... AU	1674480	1672453	100	
		0.75 - 0.75 / 18	CK1,6-ED-0,75... AU	1672440	1674914	100	
		0.75 - 1 / 18	CK1,6-ED-1,00... AU	1674943	1674888	100	
		1.5 - 1.5 / 16	CK1,6-ED-1,50... AU	1674930	1674875	100	
		2.5 - 2.5 / 14	CK1,6-ED-2,50... AU	1674985	1674927	100	

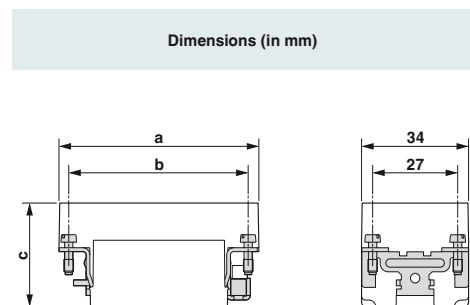

Dimensional drawing

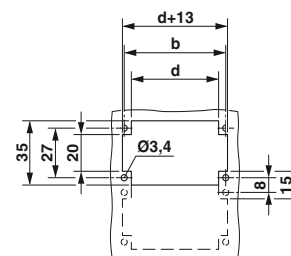

Panel cutout

	a	b	c	d
① Female	83	77.5	36	72
① Male	83.5	77.5	32.8	72
② Female	110.5	104.5	34.2	98
② Male	110.5	104.5	32.8	98

Accessories



Crimping tools
From page 670



Guide elements
From page 657



Replacement PE screws
From page 662



Thermal crimp contacts
From page 668

Heavy-duty connectors

HEAVYCON B – contact inserts

D40, D64 series terminal adapters

250 V, 10 A

Connection technology:

- Push-in connection
- Screw connection

Notes:
For accessories, see from page 654
Not for HC-EVO panel mounting bases
Only operate connectors when there is no load/the power is switched off



Type	Technical data			
	① ② HC-D 40-A-TWIN-PEL-...	③ ④ HC-D 40-A-UT-PEL-...	⑤ ⑥ HC-D 64-A-TWIN-PEL-...	⑦ ⑧ HC-D 64-A-UT-PEL-...
Approvals				
IEC data				
Rated current, contacts (at 40°C)	[A] 10	10	10	10
Overvoltage category	III	III	III	III
Degree of pollution	3	3	3	3
Rated voltage (III/3) contacts	[V] 250	250	250	250
Rated surge voltage, contacts	[kV] 6	4	6	4
Connection cross section	[mm²] 0.5 ... 2.5	0.5 ... 2.5	0.5 ... 2.5	0.2 ... 2.5
UL data				
Rated voltage	[V] 600	600	600	600
Rated current	[A] 7	7	7	7
Connection cross section	AWG 14	14	14	14
CSA / cUL data				
Rated voltage	[V] 600	600	600	600
Rated current	[A] 7	7	7	7
Connection cross section	AWG 14	14	14	14
Material data				
Contact carrier material	PA	PA	PA	PA
Inflammability class in acc. with UL 94	V0	V0	V0	V0
Contact material	Copper alloy	Copper alloy	Copper alloy	Copper alloy
Contact surface material	Ag	Ag	Ag	Ag
Temperature data				
Ambient temperature range	[°C] -40 ... 125	-40 ... 125	-40 ... 125	-40 ... 125
General data				
Connection method	Push-in connection	Screw connection	Push-in connection	Screw connection
Stripping length	[mm] 10	10	10	10
Number of positions	40	40	64	64
Contact numbering	-	-	-	-
Insertion/withdrawal cycles	≥ 500	≥ 500	≥ 500	≥ 500

Derating curves

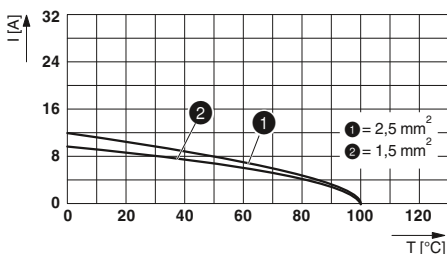



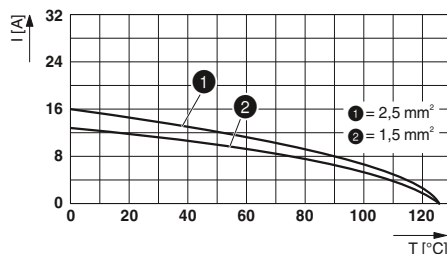



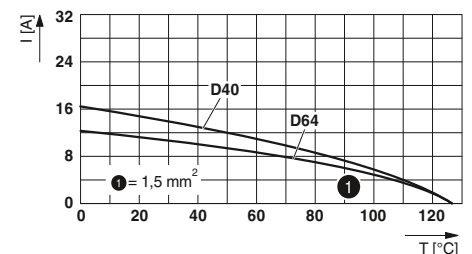

HC-D 40-A-TWIN-PEL-...

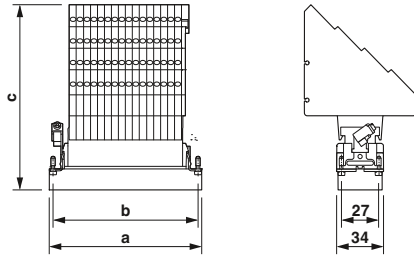

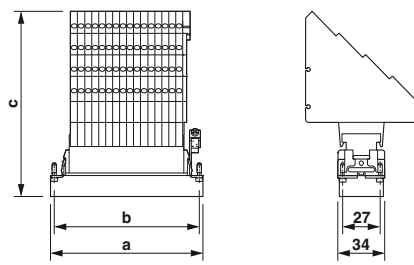
HC-D 64-A-TWIN-PEL-...

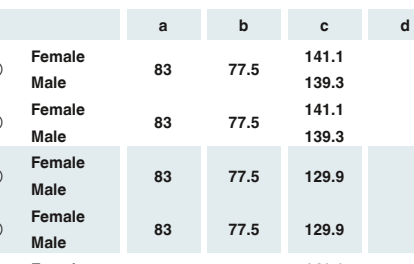

HC-D 40-A-UT-PEL-... / HC-D 64-A-UT-PEL-...

Description	Pos.	Number	Size	Type	Ordering data		Pcs./Pkt.	Dimensions (in mm)																																																																																										
					Female	Male		a	b	c	d																																																																																							
Push-in connection 	40		B16	PE left ① HC-D 40-A-TWIN-PEL...	1580147	1580150	4																																																																																											
	40		B16	PE right ② HC-D 40-A-TWIN-PER...	1580163	1580176	4																																																																																											
Screw connection 	40		B16	PE left ③ HC-D 40-A-UT-PEL...	1584253	1584240	1																																																																																											
	40		B16	PE right ④ HC-D 40-A-UT-PER...	1584279	1584266	1																																																																																											
Push-in connection 	64		B24	PE left ⑤ HC-D 64-A-TWIN-PEL...	1580189	1580192	4																																																																																											
	64		B24	PE right ⑥ HC-D 64-A-TWIN-PER...	1580202	1580215	4																																																																																											
Screw connection 	64		B24	PE left ⑦ HC-D 64-A-UT-PEL...	1584295	1584282	1	<table border="1"> <thead> <tr> <th></th> <th>a</th> <th>b</th> <th>c</th> <th>d</th> </tr> </thead> <tbody> <tr> <td>① Female</td> <td>83</td> <td>77.5</td> <td>141.1</td> <td></td> </tr> <tr> <td>① Male</td> <td>83</td> <td>77.5</td> <td>139.3</td> <td></td> </tr> <tr> <td>② Female</td> <td>83</td> <td>77.5</td> <td>141.1</td> <td></td> </tr> <tr> <td>② Male</td> <td>83</td> <td>77.5</td> <td>139.3</td> <td></td> </tr> <tr> <td>③ Female</td> <td>83</td> <td>77.5</td> <td>129.9</td> <td></td> </tr> <tr> <td>③ Male</td> <td>83</td> <td>77.5</td> <td>129.9</td> <td></td> </tr> <tr> <td>④ Female</td> <td>83</td> <td>77.5</td> <td>129.9</td> <td></td> </tr> <tr> <td>④ Male</td> <td>83</td> <td>77.5</td> <td>129.9</td> <td></td> </tr> <tr> <td>⑤ Female</td> <td>110</td> <td>104</td> <td>141.1</td> <td></td> </tr> <tr> <td>⑤ Male</td> <td>110</td> <td>104</td> <td>139.3</td> <td></td> </tr> <tr> <td>⑥ Female</td> <td>110</td> <td>104</td> <td>141.1</td> <td></td> </tr> <tr> <td>⑥ Male</td> <td>110</td> <td>104</td> <td>139.3</td> <td></td> </tr> <tr> <td>⑦ Female</td> <td>110</td> <td>104</td> <td>132.6</td> <td></td> </tr> <tr> <td>⑦ Male</td> <td>110</td> <td>104</td> <td>132.6</td> <td></td> </tr> <tr> <td>⑧ Female</td> <td>110</td> <td>104</td> <td>132.6</td> <td></td> </tr> <tr> <td>⑧ Male</td> <td>110</td> <td>104</td> <td>132.6</td> <td></td> </tr> </tbody> </table>		a	b	c	d	① Female	83	77.5	141.1		① Male	83	77.5	139.3		② Female	83	77.5	141.1		② Male	83	77.5	139.3		③ Female	83	77.5	129.9		③ Male	83	77.5	129.9		④ Female	83	77.5	129.9		④ Male	83	77.5	129.9		⑤ Female	110	104	141.1		⑤ Male	110	104	139.3		⑥ Female	110	104	141.1		⑥ Male	110	104	139.3		⑦ Female	110	104	132.6		⑦ Male	110	104	132.6		⑧ Female	110	104	132.6		⑧ Male	110	104	132.6						
		a	b	c	d																																																																																													
① Female	83	77.5	141.1																																																																																															
① Male	83	77.5	139.3																																																																																															
② Female	83	77.5	141.1																																																																																															
② Male	83	77.5	139.3																																																																																															
③ Female	83	77.5	129.9																																																																																															
③ Male	83	77.5	129.9																																																																																															
④ Female	83	77.5	129.9																																																																																															
④ Male	83	77.5	129.9																																																																																															
⑤ Female	110	104	141.1																																																																																															
⑤ Male	110	104	139.3																																																																																															
⑥ Female	110	104	141.1																																																																																															
⑥ Male	110	104	139.3																																																																																															
⑦ Female	110	104	132.6																																																																																															
⑦ Male	110	104	132.6																																																																																															
⑧ Female	110	104	132.6																																																																																															
⑧ Male	110	104	132.6																																																																																															
	64		B24	PE right ⑧ HC-D 64-A-UT-PER...	1584321	1584318	1																																																																																											
Foot element 				HC-KA-FE	1775240		10																																																																																											
Locking screw barrel 				HC-VSH	1660083		10																																																																																											

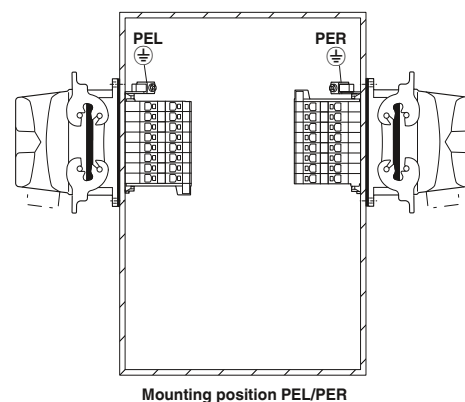

Mounting position PEL/PER

Heavy-duty connectors

HEAVYCON B – contact inserts

DD24, DD42, DD72, DD108 series

250 V, 10 A

Connection technology:

– Crimp connection

Guide pins and sockets are mandatory for HC-D... and HC-DD series contact inserts; see page 657.

To determine the corresponding housing, see the system cross-reference list on page 502.

Notes:
For accessories, see from page 654
Order crimp contacts separately
Only operate connectors when there is no load/the power is switched off



Technical data

Type	① HC-DD24-I-CT...	② HC-DD42-I-CT...	③ ④ HC-DD72-I-CT...	⑤ ⑥ HC-DD108-I-CT...
Approvals	UL, CSA, VDE, ENEC, CE	UL, CSA, VDE, ENEC, CE	UL, CSA, VDE, ENEC, CE	UL, CSA, VDE, ENEC, CE
IEC data				
Rated current, contacts (at 40°C)	10 [A]	10	10	10
Overvoltage category	III	III	III	III
Degree of pollution	3	3	3	3
Rated voltage (III/3) contacts	250 [V]	250	250	250
Rated surge voltage, contacts	4 [kV]	4	4	4
Connection cross section	0.14 ... 2.5 [mm²]	0.14 ... 2.5	0.14 ... 2.5	0.14 ... 2.5
UL data				
Rated voltage	250 [V]	250	250	250
Rated current	10 [A]	10	10	10
Connection cross section	14 AWG	14	14	14
CSA / cUL data				
Rated voltage	250 [V]	250	250	250
Rated current	7 [A]	7	7	7
Connection cross section	26-14 AWG	26-14	26-14	26-14
Material data				
Contact carrier material	PC	PC	PC	PC
Inflammability class in acc. with UL 94	V0	V0	V0	V0
Contact material	Copper alloy	Copper alloy	Copper alloy	Copper alloy
Contact surface material	Ag (alternatively Au)	Ag (alternatively Au)	Ag (alternatively Au)	Ag (alternatively Au)
Temperature data				
Ambient temperature range	-40 ... 125 [°C]	-40 ... 125	-40 ... 125	-40 ... 125
General data				
Connection method	Crimp connection	Crimp connection	Crimp connection	Crimp connection
Stripping length	8 [mm]	8	8	8
Number of positions	24	42	72	108
Contact numbering	1 - 24	1 - 42	1 - 72	1 - 108
Insertion/withdrawal cycles	≥ 500	≥ 500	≥ 500	≥ 500

Derating curves

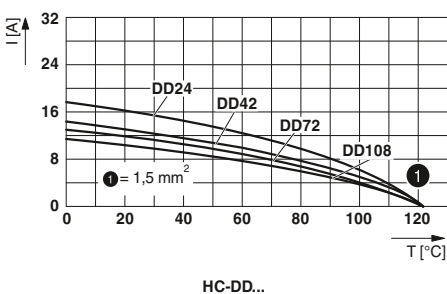

Description	Pos.	Number	Size	Ordering data			
				Type	Female	Male	Pcs./Pkt.
Crimp connection							
	24	1 - 24	B6	① HC-DD24-I-CT...	1584046	1584033	1
Crimp connection							
	42	1 - 42	B10	② HC-DD42-I-CT...	1584062	1584059	1
Crimp connection							
	72	1 - 72	B16 / B32	③ HC-DD72-I-CT...	1584091	1584075	1
	72	73 - 144	B16 / B32	④ HC-DD72-I-CT...-144	1584101	1584088	1
Crimp connection							
	108	1 - 108	B24 / B48	⑤ HC-DD108-I-CT...	1584130	1584114	1
	108	109 - 216	B24 / B48	⑥ HC-DD108-I-CT...-216	1584143	1584127	1
Turned crimp contacts CK 1,6 Silver-plated							
			Cross section mm ² / AWG				
			0.14 - 0.37 / 26 - 22	CK1,6-ED-0,37... AG	1663394	1663336	100
			0.5 - 0.5 / 20	CK1,6-ED-0,50... AG	1663404	1663349	100
			0.75 - 0.75 / 18	CK1,6-ED-0,75... AG	1663417	1663352	100
			0.75 - 1 / 18	CK1,6-ED-1,00... AG	1663420	1663365	100
			1.5 - 1.5 / 16	CK1,6-ED-1,50... AG	1663433	1663378	100
			2.5 - 2.5 / 14	CK1,6-ED-2,50... AG	1663446	1663381	100

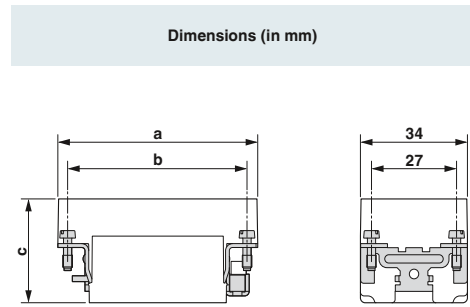

Dimensional drawing

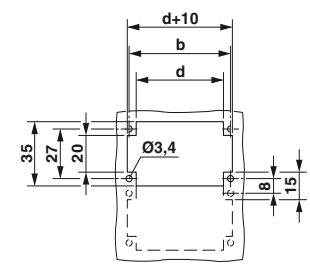

Panel cutout

	a	b	c	d
① Female			34.5	
① Male	50.5	44	32.5	36
② Female	64	57	34.5	49
② Male			32.5	
③ Female	84	77.5	34.5	72
③ Male			32.5	
④ Female	84	77.5	34.5	72
④ Male			32.5	
⑤ Female	111	104	34.5	98
⑤ Male			32.5	
⑥ Female	111	104	34.5	98
⑥ Male			32.5	

Accessories

			
Crimping tools From page 670	Guide elements From page 657	Crimp contacts, gold-plated From page 666	Replacement PE screws From page 662

Heavy-duty connectors

HEAVYCON B – contact inserts

B6 series

500 V, 10 A ... 24 A

Connection technology:

- Push-in connection
- Push-in double connection
- Screw connection
- Insulation displacement connection
- Crimp connection

To determine the corresponding housing, see the system cross-reference list on page 502.

Notes:
For accessories, see from page 654
Order crimp contacts separately
Only operate connectors when there is no load/the power is switched off
¹⁾ For flexible wires with wire end protection



Type	Technical data				
	① HC-B 6-I-PT...	② HC-B 6-I-TPT...	③ HC-B 6-I-UT...	④ HC-B 6-E...Q-2,5	⑤ HC-B 6-I-CT...
Approvals	UL, ENEC, CE	UL, ENEC, CE	UL, ENEC, CE	UL, ENEC, CE	UL, ENEC, CE
IEC data					
Rated current, contacts (at 40°C)	16	10	24	16	16
Overvoltage category	III	III	III	III	III
Degree of pollution	3	3	3	3	3
Rated voltage (III/3) contacts	500	500	500	500	500
Rated surge voltage, contacts	6	6	6	6	6
Connection cross section	0.14 ... 2.5 ¹⁾	0.25 ... 1.5 ¹⁾	0.5 ... 2.5	0.34 ... 2.5	0.5 ... 4
UL data					
Rated voltage	600	600	600	600	600
Rated current	13	14	16	10	13
Connection cross section	14	16	14	14	22-14
CSA / cUL data					
Rated voltage	600	600	600	600	600
Rated current	13	11	13	10	20
Connection cross section	14	16	22-14	16	20-12
Material data					
Contact carrier material	PC	PC	PC	PA	PA
Inflammability class in acc. with UL 94	V0	V0	V0	V0	V0
Contact material	Copper alloy	Copper alloy	Copper alloy	Copper alloy	Copper alloy
Contact surface material	Ag/Sn (tarnish protection)	Ag	Ag	Ag	Ag (alternatively Au)
Ambient conditions					
Ambient temperature range	-40 ... 125	-40 ... 125	-40 ... 125	-40 ... 125	-40 ... 125
General data					
Connection method	Push-in connection	Push-in connection	Screw connection	QUICKCON connection	Crimp connection
Stripping length	8 ... 10	8	8	-	7.5
Number of positions	6	6	6	6	6
Contact numbering	1 - 6	1 - 6	1 - 6	1 - 6	1 - 6
Insertion/withdrawal cycles	≥ 500	≥ 500	≥ 500	≥ 500	≥ 500

Derating curves

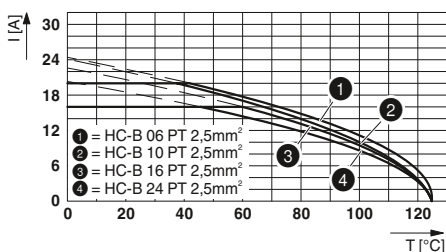



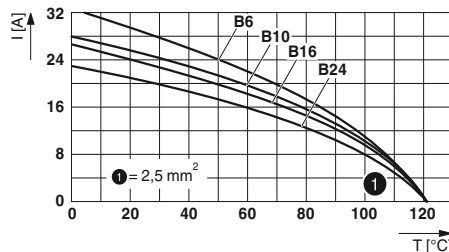



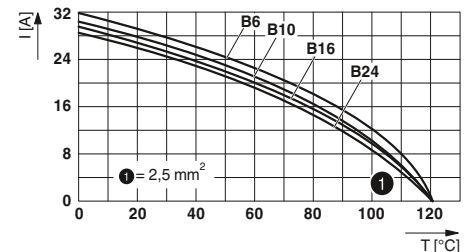

HC-B 6-I-PT...

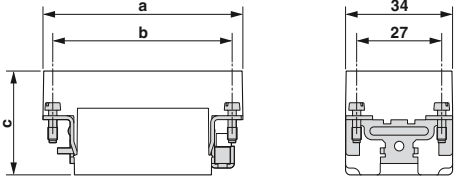

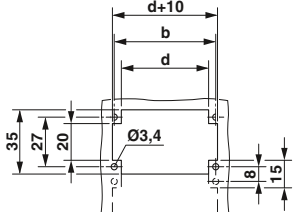
HC-B 6-I-UT...

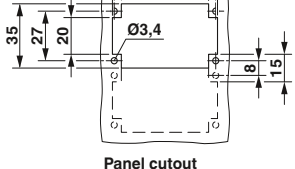

HC-B 6-I-CT...

				Ordering data																																																														
Description	Pos.	Number	Size	Type	Order No.		Pcs./Pkt.	Dimensions (in mm)																																																										
					Female	Male		Dimensional drawing																																																										
Push-in connection 	6	1 - 6	B6	① HC-B 6-I-PT...	1407727	1407728	1																																																											
Push-in double connection 	6	1 - 6	B6	② HC-B 6-I-TPT...	1423016	1423015	1																																																											
Screw connection 	6	1 - 6	B6	③ HC-B 6-I-UT...	1648128	1648115	1																																																											
Insulation displacement connection 	6	1 - 6	B6	④ HC-B 6-E...Q-2,5	1605556	1605611	10	<table border="1"> <thead> <tr> <th></th> <th>a</th> <th>b</th> <th>c</th> <th>d</th> </tr> </thead> <tbody> <tr> <td>① Female</td> <td></td> <td></td> <td>37</td> <td></td> </tr> <tr> <td>① Male</td> <td>50.5</td> <td>44</td> <td>34.4</td> <td>36</td> </tr> <tr> <td>② Female</td> <td></td> <td></td> <td>32</td> <td></td> </tr> <tr> <td>② Male</td> <td>50.5</td> <td>44</td> <td>32</td> <td>36</td> </tr> <tr> <td>③ Female</td> <td></td> <td></td> <td>34.6</td> <td></td> </tr> <tr> <td>③ Male</td> <td>50.5</td> <td>44</td> <td>32</td> <td>36</td> </tr> <tr> <td>④ Female</td> <td>51</td> <td>44</td> <td>37</td> <td></td> </tr> <tr> <td>④ Male</td> <td>51.5</td> <td>44</td> <td>35</td> <td>36</td> </tr> <tr> <td>⑤ Female</td> <td></td> <td></td> <td>34.6</td> <td></td> </tr> <tr> <td>⑤ Male</td> <td>50.5</td> <td>44</td> <td>32</td> <td>36</td> </tr> </tbody> </table>					a	b	c	d	① Female			37		① Male	50.5	44	34.4	36	② Female			32		② Male	50.5	44	32	36	③ Female			34.6		③ Male	50.5	44	32	36	④ Female	51	44	37		④ Male	51.5	44	35	36	⑤ Female			34.6		⑤ Male	50.5	44	32	36
	a	b	c	d																																																														
① Female			37																																																															
① Male	50.5	44	34.4	36																																																														
② Female			32																																																															
② Male	50.5	44	32	36																																																														
③ Female			34.6																																																															
③ Male	50.5	44	32	36																																																														
④ Female	51	44	37																																																															
④ Male	51.5	44	35	36																																																														
⑤ Female			34.6																																																															
⑤ Male	50.5	44	32	36																																																														
Crimp connection 	6	1 - 6	B6	⑤ HC-B 6-I-CT...	1648160	1648157	1																																																											
Turned crimp contacts CK 2,5 Silver-plated 								<table border="1"> <thead> <tr> <th></th> <th colspan="2">Cross section mm² / AWG</th> <th></th> <th></th> <th></th> </tr> </thead> <tbody> <tr> <td>CK2,5-ED-0,50... AG</td> <td>0.5 - 0.5</td> <td>20</td> <td>1663640</td> <td>1663572</td> <td>100</td> </tr> <tr> <td>CK2,5-ED-0,75... AG</td> <td>0.75 - 0.75</td> <td>18</td> <td>1663653</td> <td>1663585</td> <td>100</td> </tr> <tr> <td>CK2,5-ED-1,00... AG</td> <td>0.75 - 1</td> <td>18</td> <td>1663666</td> <td>1663598</td> <td>100</td> </tr> <tr> <td>CK2,5-ED-1,50... AG</td> <td>1.5 - 1.5</td> <td>16</td> <td>1663679</td> <td>1663608</td> <td>100</td> </tr> <tr> <td>CK2,5-ED-2,50... AG</td> <td>2.5 - 2.5</td> <td>14</td> <td>1663682</td> <td>1663611</td> <td>100</td> </tr> <tr> <td>CK2,5-ED-4,00... AG</td> <td>4 - 4</td> <td>12</td> <td>1663705</td> <td>1663637</td> <td>100</td> </tr> </tbody> </table>					Cross section mm ² / AWG					CK2,5-ED-0,50... AG	0.5 - 0.5	20	1663640	1663572	100	CK2,5-ED-0,75... AG	0.75 - 0.75	18	1663653	1663585	100	CK2,5-ED-1,00... AG	0.75 - 1	18	1663666	1663598	100	CK2,5-ED-1,50... AG	1.5 - 1.5	16	1663679	1663608	100	CK2,5-ED-2,50... AG	2.5 - 2.5	14	1663682	1663611	100	CK2,5-ED-4,00... AG	4 - 4	12	1663705	1663637	100													
	Cross section mm ² / AWG																																																																	
CK2,5-ED-0,50... AG	0.5 - 0.5	20	1663640	1663572	100																																																													
CK2,5-ED-0,75... AG	0.75 - 0.75	18	1663653	1663585	100																																																													
CK2,5-ED-1,00... AG	0.75 - 1	18	1663666	1663598	100																																																													
CK2,5-ED-1,50... AG	1.5 - 1.5	16	1663679	1663608	100																																																													
CK2,5-ED-2,50... AG	2.5 - 2.5	14	1663682	1663611	100																																																													
CK2,5-ED-4,00... AG	4 - 4	12	1663705	1663637	100																																																													

Accessories



Heavy-duty connectors

HEAVYCON B – contact inserts

B10 series

500 V, 10 A ... 24 A

Connection technology:

- Push-in connection
- Push-in double connection
- Screw connection
- Insulation displacement connection
- Crimp connection

To determine the corresponding housing, see the system cross-reference list on page 502.

Notes:
For accessories, see from page 654
Order crimp contacts separately
Only operate connectors when there is no load/the power is switched off
1) For flexible wires with wire end protection



Type	Technical data				
	① HC-B 10-I-PT...	② HC-B 10-I-TPT...	③ HC-B 10-I-UT...	④ HC-B 10-E... Q-2.5	⑤ HC-B 10-I-CT...
Approvals	UL ENEC VDE	UL ENEC VDE	UL ENEC VDE	UL ENEC VDE	UL ENEC VDE
IEC data					
Rated current, contacts (at 40°C)	[A] 16	10	24	16	16
Overvoltage category	III	III	III	III	III
Degree of pollution	3	3	3	3	3
Rated voltage (III/3) contacts	[V] 500	500	500	500	500
Rated surge voltage, contacts	[kV] 6	6	6	6	6
Connection cross section	[mm²] 0.14 ... 2.5¹)	0.25 ... 1.5¹)	0.5 ... 2.5	0.34 ... 2.5	0.5 ... 4
UL data					
Rated voltage	[V] 600	600	600	600	600
Rated current	[A] 13	14	16	10	13
Connection cross section	AWG 14	16	14	14	22-14
CSA / cUL data					
Rated voltage	[V] 600	600	600	600	600
Rated current	[A] 10	11	13	10	20
Connection cross section	AWG 14	16	22-14	16	20-12
Material data					
Contact carrier material	PC	PC	PC	PA	PA
Inflammability class in acc. with UL 94	V0	V0	V0	V0	V0
Contact material	Copper alloy	Copper alloy	Copper alloy	Copper alloy	Copper alloy
Contact surface material	Ag/Sn (tarnish protection)	Ag	Ag	Ag	Ag (alternatively Au)
Ambient conditions					
Ambient temperature range	[°C] -40 ... 125	-40 ... 125	-40 ... 125	-40 ... 125	-40 ... 125
General data					
Connection method	Push-in connection	Push-in connection	Screw connection	QUICKON connection	Crimp connection
Stripping length	[mm] 8 ... 10	8	8	-	7.5
Number of positions	10	10	10	10	10
Contact numbering	1 - 10	1 - 10	1 - 10	1 - 10	1 - 10
Insertion/withdrawal cycles	≥ 500	≥ 500	≥ 500	≥ 500	≥ 500

Derating curves

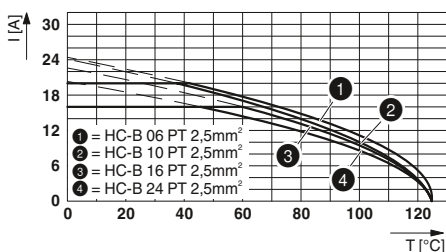

HC-B 10-I-PT...

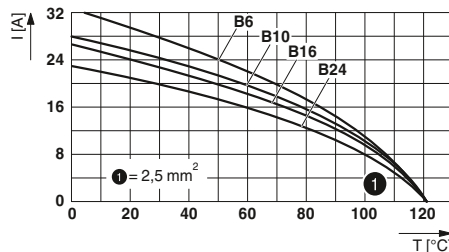

HC-B 10-I-UT...

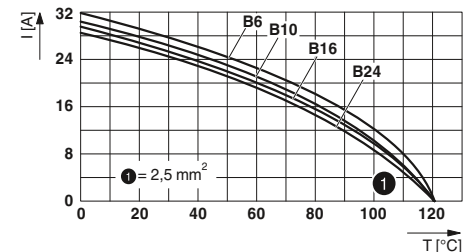

HC-B 10-I-CT...

				Ordering data																																																																	
Description	Pos.	Number	Size	Type	Order No.		Pcs./Pkt.	Dimensions (in mm)																																																													
					Female	Male																																																															
Push-in connection																																																																					
	10	1 - 10	B10	① HC-B 10-I-PT...	1407729	1407730	1																																																														
Push-in double connection											<p>Dimensional drawing</p> <p>Panel cutout</p>																																																										
	10	1 - 10	B10	② HC-B 10-I-TPT...	1423018	1423017	1																																																														
Screw connection																																																																					
	10	1 - 10	B10	③ HC-B 10-I-UT...	1648186	1648173	1																																																														
Insulation displacement connection											<table border="1"> <thead> <tr> <th></th> <th>a</th> <th>b</th> <th>c</th> <th>d</th> </tr> </thead> <tbody> <tr> <td>① Female</td> <td>64</td> <td>57</td> <td>37</td> <td>49</td> </tr> <tr> <td>① Male</td> <td>64</td> <td>57</td> <td>34.4</td> <td>49</td> </tr> <tr> <td>② Female</td> <td>64</td> <td>57</td> <td>32</td> <td>49</td> </tr> <tr> <td>② Male</td> <td>64</td> <td>57</td> <td>32</td> <td>49</td> </tr> <tr> <td>③ Female</td> <td>64</td> <td>57</td> <td>34.6</td> <td>49</td> </tr> <tr> <td>③ Male</td> <td>64</td> <td>57</td> <td>32</td> <td>49</td> </tr> <tr> <td>④ Female</td> <td>64</td> <td>57</td> <td>37</td> <td>49</td> </tr> <tr> <td>④ Male</td> <td>64</td> <td>57</td> <td>35</td> <td>49</td> </tr> <tr> <td>⑤ Female</td> <td>64</td> <td>57</td> <td>34.6</td> <td>49</td> </tr> <tr> <td>⑤ Male</td> <td>64</td> <td>57</td> <td>32</td> <td>49</td> </tr> </tbody> </table>					a	b	c	d	① Female	64	57	37	49	① Male	64	57	34.4	49	② Female	64	57	32	49	② Male	64	57	32	49	③ Female	64	57	34.6	49	③ Male	64	57	32	49	④ Female	64	57	37	49	④ Male	64	57	35	49	⑤ Female	64	57	34.6	49	⑤ Male	64	57	32	49
	a	b	c	d																																																																	
① Female	64	57	37	49																																																																	
① Male	64	57	34.4	49																																																																	
② Female	64	57	32	49																																																																	
② Male	64	57	32	49																																																																	
③ Female	64	57	34.6	49																																																																	
③ Male	64	57	32	49																																																																	
④ Female	64	57	37	49																																																																	
④ Male	64	57	35	49																																																																	
⑤ Female	64	57	34.6	49																																																																	
⑤ Male	64	57	32	49																																																																	
	10	1 - 10	B10	④ HC-B 10-E...Q-2,5	1605569	1605624	10																																																														
Crimp connection																																																																					
	10	1 - 10	B10	⑤ HC-B 10-I-CT...	1648225	1648212	1																																																														
Turned crimp contacts CK 2,5		Cross section																																																																			
Silver-plated		mm² / AWG																																																																			
		0.5 - 0.5 / 20		CK2,5-ED-0,50... AG		1663640		1663572		100																																																											
		0.75 - 0.75 / 18		CK2,5-ED-0,75... AG		1663653		1663585		100																																																											
		0.75 - 1 / 18		CK2,5-ED-1,00... AG		1663666		1663598		100																																																											
		1.5 - 1.5 / 16		CK2,5-ED-1,50... AG		1663679		1663608		100																																																											
		2.5 - 2.5 / 14		CK2,5-ED-2,50... AG		1663682		1663611		100																																																											
		4 - 4 / 12		CK2,5-ED-4,00... AG		1663705		1663637		100																																																											

Accessories



Crimping tools
From page 670



Coding elements
From page 656



Crimp contacts, gold-plated
From page 666



Replacement PE screws
From page 662

Heavy-duty connectors

HEAVYCON B – contact inserts

B16 series

500 V, 10 A ... 20 A

Connection technology:

- Push-in connection
- Push-in double connection
- Screw connection
- Insulation displacement connection
- Crimp connection

To determine the corresponding housing, see the system cross-reference list on page 502.

Notes:
For accessories, see from page 654
Order crimp contacts separately
Only operate connectors when there is no load/the power is switched off
¹⁾ For flexible wires with wire end protection



Type	Technical data				
	① ② HC-B 16-I-PT-...	③ ④ HC-B 16-I-TPT-...	⑤ ⑥ HC-B 16-I-UT-...	⑦ ⑧ HC-B 16-E-Q-2,5	⑨ ⑩ HC-B 16-I-CT-...
Approvals	UL ENEC IEC	UL ENEC IEC	UL ENEC IEC	UL ENEC IEC	UL ENEC IEC
IEC data					
Rated current, contacts (at 40°C)	[A] 16	10	20	16	16
Overvoltage category	III	III	III	III	III
Degree of pollution	3	3	3	3	3
Rated voltage (III/3) contacts	[V] 500	500	500	500	500
Rated surge voltage, contacts	[kV] 6	6	6	6	6
Connection cross section	[mm ²] 0.14 ... 2.5 ¹⁾	0.25 ... 1.5 ¹⁾	0.5 ... 2.5	0.34 ... 2.5	0.5 ... 4
UL data					
Rated voltage	[V] 600	600	600	600	600
Rated current	[A] 13	14	16	10	13
Connection cross section	AWG 14	16	14	14	22-14
CSA / cUL data					
Rated voltage	[V] 600	600	600	600	600
Rated current	[A] 10	11	13	10	20
Connection cross section	AWG 14	16	22-14	16	20-12
Material data					
Contact carrier material	PC	PC	PC	PA	PA
Inflammability class in acc. with UL 94	V0	V0	V0	V0	V0
Contact material	Copper alloy	Copper alloy	Copper alloy	Copper alloy	Copper alloy
Contact surface material	Ag/Sn (tarnish protection)	Ag	Ag	Ag	Ag (alternatively Au)
Ambient conditions					
Ambient temperature range	[°C] -40 ... 125	-40 ... 125	-40 ... 125	-40 ... 125	-40 ... 125
General data					
Connection method	Push-in connection	Push-in connection	Screw connection	QUICKON connection	Crimp connection
Stripping length	[mm] 8 ... 10	8	8	-	7.5
Number of positions	16	16	16	16	16
Contact numbering	1 - 16	1 - 16	1 - 16	1 - 16	1 - 16
Insertion/withdrawal cycles	≥ 500	≥ 500	≥ 500	≥ 500	≥ 500

Derating curves

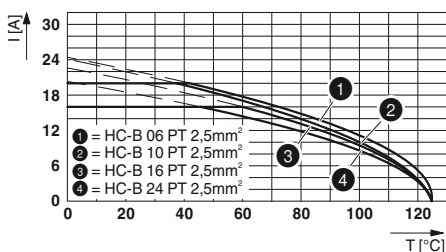

HC-B 16-I-PT-...

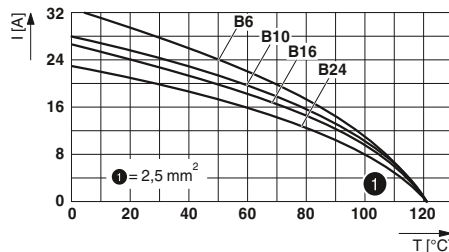

HC-B 16-I-UT-...

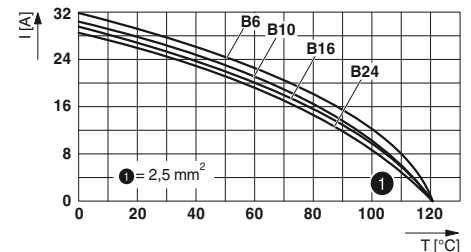

HC-B 16-I-CT-...

				Ordering data																																																																																																							
Description	Pos.	Number	Size	Type	Order No.		Pcs./Pkt.	Dimensions (in mm)																																																																																																			
					Female	Male		Dimensional drawing																																																																																																			
Push-in connection																																																																																																											
	16	1 - 16	B16 / B32	① HC-B 16-I-PT...	1407731	1407732	1																																																																																																				
	16	17 - 32	B16 / B32	② HC-B 16-I-PT...-32	1407733	1407734	1																																																																																																				
Push-in double connection											<p>Panel cutout</p>																																																																																																
	16	1 - 16	B16	③ HC-B 16-I-TPT...	1423020	1423019	1																																																																																																				
	16	17 - 32	B16 / B32	④ HC-B 16-I-TPT...-32	1423826	1423825	1																																																																																																				
Screw connection											<p>Panel cutout</p>																																																																																																
	16	1 - 16	B16 / B32	⑤ HC-B 16-I-UT...	1648241	1648238	1																																																																																																				
	16	17 - 32	B16 / B32	⑥ HC-B 16-I-UT...-32	1584884	1584871	1																																																																																																				
Insulation displacement connection											<table border="1"> <thead> <tr> <th></th> <th>a</th> <th>b</th> <th>c</th> <th>d</th> </tr> </thead> <tbody> <tr> <td rowspan="2">⑦</td> <td>Female</td> <td>84</td> <td>77.5</td> <td>37</td> <td>72</td> </tr> <tr> <td>Male</td> <td>84</td> <td>77.5</td> <td>34.4</td> <td>72</td> </tr> <tr> <td rowspan="2">⑧</td> <td>Female</td> <td>84</td> <td>77.5</td> <td>34.6</td> <td>72</td> </tr> <tr> <td>Male</td> <td>84</td> <td>77.5</td> <td>34.6</td> <td>72</td> </tr> <tr> <td rowspan="2">⑤</td> <td>Female</td> <td>84</td> <td>77.5</td> <td>34.6</td> <td>72</td> </tr> <tr> <td>Male</td> <td>84</td> <td>77.5</td> <td>32</td> <td>72</td> </tr> <tr> <td rowspan="2">⑥</td> <td>Female</td> <td>84</td> <td>77.5</td> <td>34.6</td> <td>72</td> </tr> <tr> <td>Male</td> <td>84</td> <td>77.5</td> <td>32</td> <td>72</td> </tr> <tr> <td rowspan="2">⑦</td> <td>Female</td> <td>84.5</td> <td>77.5</td> <td>37</td> <td>72</td> </tr> <tr> <td>Male</td> <td>84.5</td> <td>77.5</td> <td>35</td> <td>72</td> </tr> <tr> <td rowspan="2">⑧</td> <td>Female</td> <td>84.5</td> <td>77.5</td> <td>37</td> <td>72</td> </tr> <tr> <td>Male</td> <td>84.5</td> <td>77.5</td> <td>35</td> <td>72</td> </tr> <tr> <td rowspan="2">⑨</td> <td>Female</td> <td>84</td> <td>77.5</td> <td>34.6</td> <td>72</td> </tr> <tr> <td>Male</td> <td>84</td> <td>77.5</td> <td>32</td> <td>72</td> </tr> <tr> <td rowspan="2">⑩</td> <td>Female</td> <td>84</td> <td>77.5</td> <td>34.6</td> <td>72</td> </tr> <tr> <td>Male</td> <td>84</td> <td>77.5</td> <td>32</td> <td>72</td> </tr> </tbody> </table>					a	b	c	d	⑦	Female	84	77.5	37	72	Male	84	77.5	34.4	72	⑧	Female	84	77.5	34.6	72	Male	84	77.5	34.6	72	⑤	Female	84	77.5	34.6	72	Male	84	77.5	32	72	⑥	Female	84	77.5	34.6	72	Male	84	77.5	32	72	⑦	Female	84.5	77.5	37	72	Male	84.5	77.5	35	72	⑧	Female	84.5	77.5	37	72	Male	84.5	77.5	35	72	⑨	Female	84	77.5	34.6	72	Male	84	77.5	32	72	⑩	Female	84	77.5	34.6	72	Male	84	77.5	32	72
	a	b	c	d																																																																																																							
⑦	Female	84	77.5	37	72																																																																																																						
	Male	84	77.5	34.4	72																																																																																																						
⑧	Female	84	77.5	34.6	72																																																																																																						
	Male	84	77.5	34.6	72																																																																																																						
⑤	Female	84	77.5	34.6	72																																																																																																						
	Male	84	77.5	32	72																																																																																																						
⑥	Female	84	77.5	34.6	72																																																																																																						
	Male	84	77.5	32	72																																																																																																						
⑦	Female	84.5	77.5	37	72																																																																																																						
	Male	84.5	77.5	35	72																																																																																																						
⑧	Female	84.5	77.5	37	72																																																																																																						
	Male	84.5	77.5	35	72																																																																																																						
⑨	Female	84	77.5	34.6	72																																																																																																						
	Male	84	77.5	32	72																																																																																																						
⑩	Female	84	77.5	34.6	72																																																																																																						
	Male	84	77.5	32	72																																																																																																						
	16	1 - 16	B16 / B32	⑦ HC-B 16-E...Q-2,5	1605572	1605637	10																																																																																																				
	16	17 - 32	B16 / B32	⑧ HC-B 16-E...Q-2,5-32	1605598	1605653	10																																																																																																				
Crimp connection																																																																																																											
	16	1 - 16	B16 / B32	⑨ HC-B 16-I-CT...	1648283	1648270	1																																																																																																				
	16	17 - 32	B16 / B32	⑩ HC-B 16-I-CT...-32	1584923	1584910	1																																																																																																				
Turned crimp contacts CK 2,5		Cross section																																																																																																									
		mm ² / AWG		CK2,5-ED-0,50... AG		1663640	1663572	100																																																																																																			
		0.5 - 0.5 / 20		CK2,5-ED-0,75... AG		1663653	1663585	100																																																																																																			
		0.75 - 0.75 / 18		CK2,5-ED-1,00... AG		1663666	1663598	100																																																																																																			
		0.75 - 1 / 18		CK2,5-ED-1,50... AG		1663679	1663608	100																																																																																																			
		1.5 - 1.5 / 16		CK2,5-ED-2,50... AG		1663682	1663611	100																																																																																																			
		2.5 - 2.5 / 14		CK2,5-ED-4,00... AG		1663705	1663637	100																																																																																																			
4 - 4 / 12																																																																																																											

Accessories



Crimping tools
From page 670



Coding elements
From page 656



Crimp contacts, gold-plated
From page 666



Replacement PE screws
From page 662

Heavy-duty connectors

HEAVYCON B – contact inserts

B24 series

500 V, 10 A ... 20 A

Connection technology:

- Push-in connection
- Push-in double connection
- Screw connection
- Insulation displacement connection
- Crimp connection

To determine the corresponding housing, see the system cross-reference list on page 502.

Notes:
For accessories, see from page 654
Order crimp contacts separately
Only operate connectors when there is no load/the power is switched off
¹⁾ For flexible wires with wire end protection

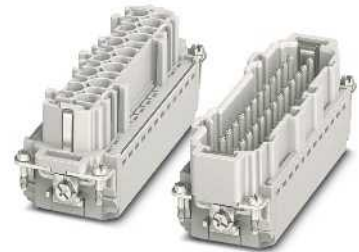

Type	Technical data				
	① ② HC-B 24-I-PT-...	③ ④ HC-B 24-I-TPT-...	⑤ ⑥ HC-B 24-I-UT-...	⑦ ⑧ HC-B 24-E...Q-2,5	⑨ ⑩ HC-B 24-I-CT-...
Approvals	UL ENEC IEC	UL ENEC IEC	UL ENEC IEC	UL ENEC IEC	UL ENEC IEC
IEC data					
Rated current, contacts (at 40°C)	[A] 16	10	20	16	16
Overvoltage category	III	III	III	III	III
Degree of pollution	3	3	3	3	3
Rated voltage (III/3) contacts	[V] 500	500	500	500	500
Rated surge voltage, contacts	[kV] 6	6	6	6	6
Connection cross section	[mm²] 0.14 ... 2.5 ¹⁾	0.25 ... 1.5 ¹⁾	0.5 ... 2.5	0.34 ... 2.5	0.5 ... 4
UL data					
Rated voltage	[V] 600	600	600	600	600
Rated current	[A] 13	13	16	10	13
Connection cross section	AWG 14	16	14	14	22-14
CSA / cUL data					
Rated voltage	[V] 600	600	600	600	600
Rated current	[A] 10	10	13	10	20
Connection cross section	AWG 14	16	22-14	16	20-12
Material data					
Contact carrier material	PC	PC	PC	PA	PA
Inflammability class in acc. with UL 94	V0	V0	V0	V0	V0
Contact material	Copper alloy	Copper alloy	Copper alloy	Copper alloy	Copper alloy
Contact surface material	Ag/Sn (tarnish protection)	Ag	Ag	Ag	Ag (alternatively Au)
Ambient conditions					
Ambient temperature range	[°C] -40 ... 125	-40 ... 125	-40 ... 125	-40 ... 125	-40 ... 125
General data					
Connection method	Push-in connection	Push-in connection	Screw connection	QUICKON connection	Crimp connection
Stripping length	[mm] 8 ... 10	8	8	-	7.5
Number of positions	24	24	24	24	24
Contact numbering	1 - 24	1 - 24	1 - 24	1 - 24	1 - 24
Insertion/withdrawal cycles	≥ 500	≥ 500	≥ 500	≥ 500	≥ 500

Derating curves

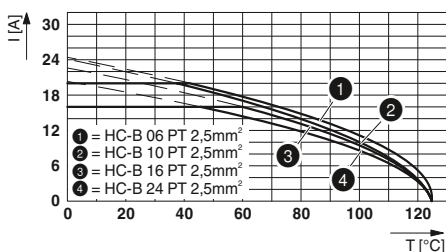

HC-B 24-I-PT-...

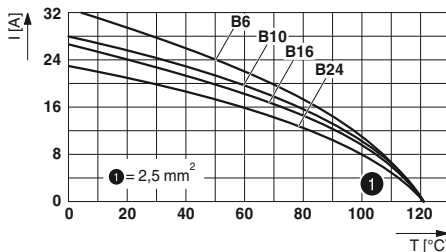

HC-B 24-I-UT-...

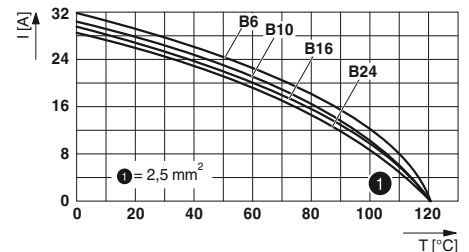

HC-B 24-I-CT-...

				Ordering data																																																																																																											
Description	Pos.	Number	Size	Type	Order No.		Pcs./Pkt.	Dimensions (in mm)																																																																																																							
					Female	Male		Dimensional drawing																																																																																																							
Push-in connection																																																																																																															
	24	1 - 24	B24 / B48	① HC-B 24-I-PT...	1407735	1407736	1																																																																																																								
	24	25 - 48	B24 / B48	② HC-B 24-I-PT...-48	1407737	1407738	1	<p>Panel cutout</p> <table border="1"> <thead> <tr> <th></th> <th>a</th> <th>b</th> <th>c</th> <th>d</th> </tr> </thead> <tbody> <tr> <td>① Female</td> <td>111</td> <td>104</td> <td>37</td> <td>98</td> </tr> <tr> <td>① Male</td> <td>111</td> <td>104</td> <td>34.4</td> <td>98</td> </tr> <tr> <td>② Female</td> <td>111</td> <td>104</td> <td>37</td> <td>98</td> </tr> <tr> <td>② Male</td> <td>111</td> <td>104</td> <td>34.4</td> <td>98</td> </tr> <tr> <td>③ Female</td> <td>111</td> <td>104</td> <td>34.6</td> <td>98</td> </tr> <tr> <td>④ Female</td> <td>111</td> <td>104</td> <td>34.6</td> <td>98</td> </tr> <tr> <td>④ Male</td> <td>111</td> <td>104</td> <td>34.6</td> <td>98</td> </tr> <tr> <td>⑤ Female</td> <td>111</td> <td>104</td> <td>34.6</td> <td>98</td> </tr> <tr> <td>⑤ Male</td> <td>111</td> <td>104</td> <td>32</td> <td>98</td> </tr> <tr> <td>⑥ Female</td> <td>111</td> <td>104</td> <td>34.6</td> <td>98</td> </tr> <tr> <td>⑥ Male</td> <td>111</td> <td>104</td> <td>32</td> <td>98</td> </tr> <tr> <td>⑦ Female</td> <td>111</td> <td>104</td> <td>37</td> <td>98</td> </tr> <tr> <td>⑦ Male</td> <td>111</td> <td>104</td> <td>35</td> <td>98</td> </tr> <tr> <td>⑧ Female</td> <td>111</td> <td>104</td> <td>37</td> <td>98</td> </tr> <tr> <td>⑧ Male</td> <td>111</td> <td>104</td> <td>35</td> <td>98</td> </tr> <tr> <td>⑨ Female</td> <td>111</td> <td>104</td> <td>34.6</td> <td>98</td> </tr> <tr> <td>⑨ Male</td> <td>111</td> <td>104</td> <td>32</td> <td>98</td> </tr> <tr> <td>⑩ Female</td> <td>111</td> <td>104</td> <td>34.6</td> <td>98</td> </tr> <tr> <td>⑩ Male</td> <td>111</td> <td>104</td> <td>32</td> <td>98</td> </tr> </tbody> </table>					a	b	c	d	① Female	111	104	37	98	① Male	111	104	34.4	98	② Female	111	104	37	98	② Male	111	104	34.4	98	③ Female	111	104	34.6	98	④ Female	111	104	34.6	98	④ Male	111	104	34.6	98	⑤ Female	111	104	34.6	98	⑤ Male	111	104	32	98	⑥ Female	111	104	34.6	98	⑥ Male	111	104	32	98	⑦ Female	111	104	37	98	⑦ Male	111	104	35	98	⑧ Female	111	104	37	98	⑧ Male	111	104	35	98	⑨ Female	111	104	34.6	98	⑨ Male	111	104	32	98	⑩ Female	111	104	34.6	98	⑩ Male	111	104	32	98
	a	b	c	d																																																																																																											
① Female	111	104	37	98																																																																																																											
① Male	111	104	34.4	98																																																																																																											
② Female	111	104	37	98																																																																																																											
② Male	111	104	34.4	98																																																																																																											
③ Female	111	104	34.6	98																																																																																																											
④ Female	111	104	34.6	98																																																																																																											
④ Male	111	104	34.6	98																																																																																																											
⑤ Female	111	104	34.6	98																																																																																																											
⑤ Male	111	104	32	98																																																																																																											
⑥ Female	111	104	34.6	98																																																																																																											
⑥ Male	111	104	32	98																																																																																																											
⑦ Female	111	104	37	98																																																																																																											
⑦ Male	111	104	35	98																																																																																																											
⑧ Female	111	104	37	98																																																																																																											
⑧ Male	111	104	35	98																																																																																																											
⑨ Female	111	104	34.6	98																																																																																																											
⑨ Male	111	104	32	98																																																																																																											
⑩ Female	111	104	34.6	98																																																																																																											
⑩ Male	111	104	32	98																																																																																																											
Push-in double connection																																																																																																															
	24	1 - 24	B24	③ HC-B 24-I-TPT...	1423022	1423021	1																																																																																																								
	24 / 0	25 - 48	B24 / B48	④ HC-B 24-I-TPT...-48	1423828	1423827	1																																																																																																								
Screw connection																																																																																																															
	24	1 - 24	B24 / B48	⑤ HC-B 24-I-UT...	1648306	1648296	1																																																																																																								
	24	25 - 48	B24 / B48	⑥ HC-B 24-I-UT...-48	1584949	1584936	1																																																																																																								
Insulation displacement connection																																																																																																															
	24	1 - 24	B24 / B48	⑦ HC-B 24-E...Q-2,5	1605585	1605640	10																																																																																																								
	24	1 - 24	B24 / B48	⑧ HC-B 24-E...Q-2,5-48	1605608	1605666	10																																																																																																								
Crimp connection																																																																																																															
	24	1 - 24	B24 / B48	⑨ HC-B 24-I-CT...	1648348	1648335	1																																																																																																								
	24	25 - 48	B24 / B48	⑩ HC-B 24-I-CT...-48	1584981	1584978	1																																																																																																								
Turned crimp contacts CK 2,5 Silver-plated																																																																																																															
			Cross section mm ² / AWG	CK2,5-ED-0,50... AG	1663640	1663572	100																																																																																																								
			0.5 - 0.5 / 20	CK2,5-ED-0,75... AG	1663653	1663585	100																																																																																																								
			0.75 - 0.75 / 18	CK2,5-ED-1,00... AG	1663666	1663598	100																																																																																																								
			0.75 - 1 / 18	CK2,5-ED-1,50... AG	1663679	1663608	100																																																																																																								
			1.5 - 1.5 / 16	CK2,5-ED-2,50... AG	1663682	1663611	100																																																																																																								
			2.5 - 2.5 / 14	CK2,5-ED-4,00... AG	1663705	1663637	100																																																																																																								
			4 - 4 / 12																																																																																																												

Accessories



Crimping tools
From page 670



Coding elements
From page 656



Crimp contacts, gold-plated
From page 666



Replacement PE screws
From page 662

Heavy-duty connectors

HEAVYCON B – contact inserts

B6, B10, B16, B24 series terminal adapters

500 V, 16 A

Connection technology:
– Push-in connection

Notes:
For accessories, see from page 654
Only operate connectors when there is no load/the power is switched off







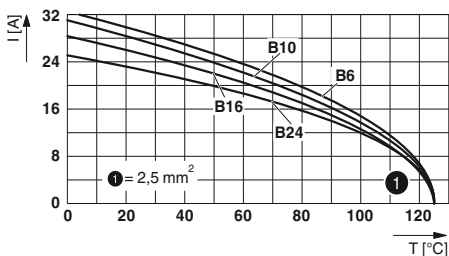

Type	Technical data			
	① ② HC-B 6-A-DT-PEL-...	③ ④ HC-B 10-A-DT-PEL-...	⑤ ⑥ HC-B 16-A-DT-PEL-...	⑦ ⑧ HC-B 24-A-DT-PEL-...
Approvals				
IEC data				
Rated current, contacts (at 40°C)	16 [A]	16	16	16
Overvoltage category	III	III	III	III
Degree of pollution	3	3	3	3
Rated voltage (III/3) contacts	500 [V]	500	500	500
Rated surge voltage, contacts	6 [kV]	6	6	6
Connection cross section	0.5 ... 2.5 [mm²]	0.5 ... 2.5	0.5 ... 2.5	0.5 ... 2.5
UL data				
Rated voltage	600 [V]	600	600	600
Rated current	13 [A]	13	13	13
Connection cross section	22-14 AWG	22-14	22-14	22-14
CSA / cUL data				
Rated voltage	600 [V]	600	600	600
Rated current	13 [A]	13	13	13
Connection cross section	22-14 AWG	22-14	22-14	22-14
Material data				
Contact carrier material	PA	PA	PA	PA
Inflammability class in acc. with UL 94	V0	V0	V0	V0
Contact material	Copper alloy	Copper alloy	Copper alloy	Copper alloy
Contact surface material	Ag	Ag	Ag	Ag
Temperature data				
Ambient temperature range	-40 ... 125 [°C]	-40 ... 125	-40 ... 125	-40 ... 125
General data				
Connection method	Push-in connection	Push-in connection	Push-in connection	Push-in connection
Stripping length	10 [mm]	10	10	10
Number of positions	6	10	16	24
Contact numbering	1 - 6	1 - 10	1 - 16	1 - 24
Insertion/withdrawal cycles	≥ 500	≥ 500	≥ 500	≥ 500

Derating curves



HC-B ...-A-DT-PER-...

Description	Pos.	Number	Size	Type	Ordering data		Pcs./Pkt.
					Female	Male	
Push-in connection 	6	1 - 6	B6	PE left ① HC-B 6-A-DT-PEL-...	1648351	1648364	5
	6	1 - 6	B6	PE right ② HC-B 6-A-DT-PER-...	1648377	1648380	5
Push-in connection 	10	1 - 10	B10	PE left ③ HC-B 10-A-DT-PEL-...	1648393	1648403	5
	10	1 - 10	B10	PE right ④ HC-B 10-A-DT-PER-...	1648416	1648429	5
Push-in connection 	16	1 - 16	B16	PE left ⑤ HC-B 16-A-DT-PEL-...	1648432	1648445	5
	16	1 - 16	B16	PE right ⑥ HC-B 16-A-DT-PER-...	1648458	1648461	5
Push-in connection 	24	1 - 24	B24	PE left ⑦ HC-B 24-A-DT-PEL-...	1648474	1648487	5
	24	1 - 24	B24	PE right ⑧ HC-B 24-A-DT-PER-...	1648490	1648500	5
Foot element 				HC-KA-FE	1775240		10
Locking screw barrel 				HC-VSH	1660083		10

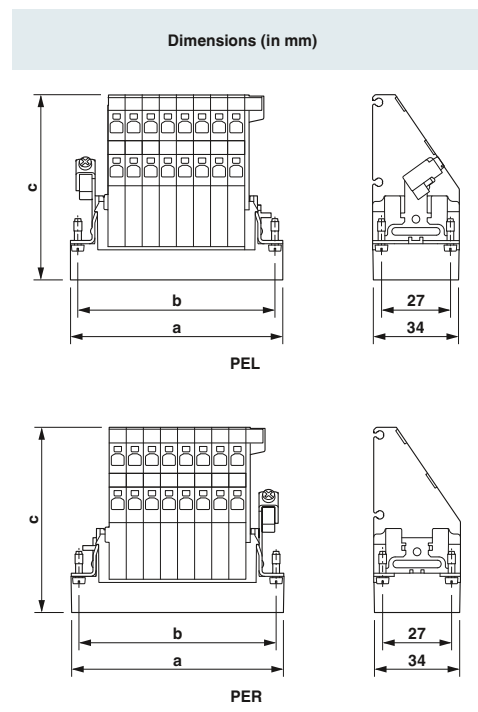

	a	b	c	d
① Female	50.5	44	72.1	
① Male	50.5	44	70.5	
② Female	50.5	44	72.1	
② Male	50.5	44	70.5	
③ Female	64	57	72.1	
③ Male	64	57	70.5	
④ Female	64	57	72.1	
④ Male	64	57	70.5	
⑤ Female	84	77.5	72.1	
⑤ Male	84	77.5	70.5	
⑥ Female	84	77.5	72.1	
⑥ Male	84	77.5	70.5	
⑦ Female	111	104	72.1	
⑦ Male	111	104	70.5	
⑧ Female	111	104	72.1	
⑧ Male	111	104	70.5	

Accessories



Coding elements
From page 656

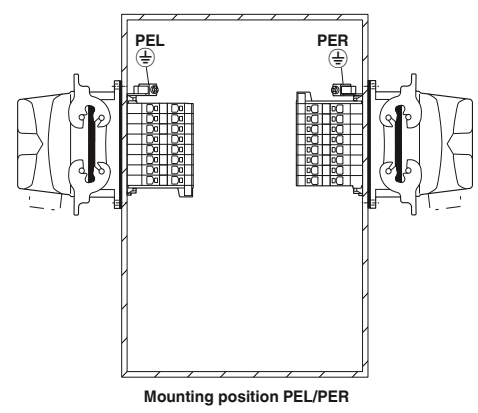

Heavy-duty connectors

HEAVYCON B – contact inserts

B6, B10, B16, B24 series terminal adapters

500 V, 16 A

Connection technology:
– Screw connection







Notes:
For accessories, see from page 654
Only operate connectors when there is no load/the power is switched off

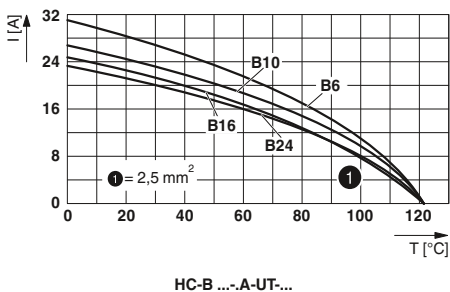

Type	Technical data			
	① ② HC-B 6-A-UT-PEL-...	③ ④ HC-B 10-A-UT-PEL-...	⑤ ⑥ HC-B 16-A-UT-PEL-...	⑦ ⑧ HC-B 24-A-UT-PEL-...
Approvals				
IEC data				
Rated current, contacts (at 40°C)	[A] 16	16	16	16
Overvoltage category	III	III	III	III
Degree of pollution	3	3	3	3
Rated voltage (III/3) contacts	[V] 500	500	500	500
Rated surge voltage, contacts	[kV] 6	6	6	6
Connection cross section	[mm²] 0.5 ... 2.5	0.5 ... 2.5	0.5 ... 2.5	0.5 ... 2.5
UL data				
Rated voltage	[V] 600	600	600	600
Rated current	[A] 13	13	13	13
Connection cross section	AWG 22-14	22-14	22-14	22-14
CSA / cUL data				
Rated voltage	[V] 600	600	600	600
Rated current	[A] 13	13	13	13
Connection cross section	AWG 22-14	22-14	22-14	22-14
Material data				
Contact carrier material	PA	PA	PA	PA
Inflammability class in acc. with UL 94	V0	V0	V0	V0
Contact material	Copper alloy	Copper alloy	Copper alloy	Copper alloy
Contact surface material	Ag	Ag	Ag	Ag
Temperature data				
Ambient temperature range	[°C] -40 ... 125	-40 ... 125	-40 ... 125	-40 ... 125
General data				
Connection method	Screw connection	Screw connection	Screw connection	Screw connection
Stripping length	[mm] 12	12	12	12
Number of positions	6	10	16	24
Contact numbering	1 - 6	1 - 10	1 - 16	1 - 24
Insertion/withdrawal cycles	≥ 500	≥ 500	≥ 500	≥ 500

Derating curves



Description	Pos.	Number	Size	Type	Ordering data		Pcs./Pkt.
					Female	Male	
Screw connection 	6	1 - 6	B6	PE left ① HC-B 6-A-UT-PEL-...	1648018	1648024	5
	6	1 - 6	B6	PE right ② HC-B 6-A-UT-PER-...	1648066	1648072	5
Screw connection 	10	1 - 10	B10	PE left ③ HC-B 10-A-UT-PEL-...	1648030	1648036	5
	10	1 - 10	B10	PE right ④ HC-B 10-A-UT-PER-...	1648078	1648084	5
Screw connection 	16	1 - 16	B16	PE left ⑤ HC-B 16-A-UT-PEL-...	1648042	1648048	5
	16	1 - 16	B16	PE right ⑥ HC-B 16-A-UT-PER-...	1648090	1648096	5
Screw connection 	24	1 - 24	B24	PE left ⑦ HC-B 24-A-UT-PEL-...	1648054	1648060	5
	24	1 - 24	B24	PE right ⑧ HC-B 24-A-UT-PER-...	1648102	1648108	5
Foot element 				HC-KA-FE	1775240		10
Locking screw barrel 				HC-VSH	1660083		10

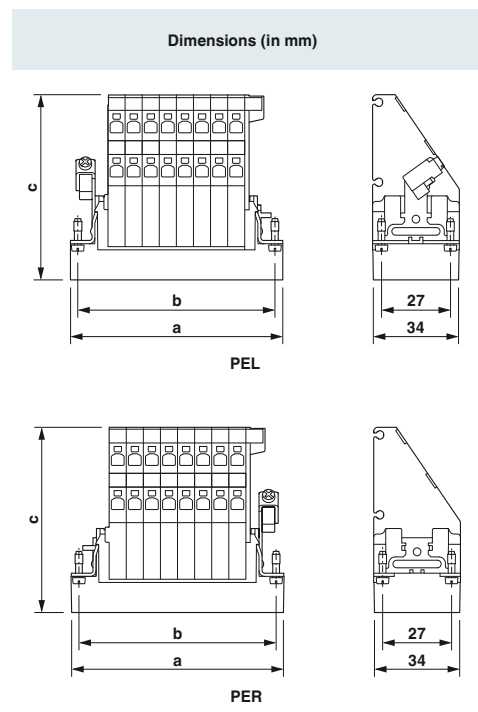

	a	b	c	d
① Female	51	44	74.2	
① Male	51	44	71.6	
② Female	51	44	74.2	
② Male	51	44	71.6	
③ Female	64	57	74.2	
③ Male	64	57	71.6	
④ Female	64	57	74.2	
④ Male	64	57	71.6	
⑤ Female	84.5	77.5	74.2	
⑤ Male	84.5	77.5	71.6	
⑥ Female	84.5	77.5	74.2	
⑥ Male	84.5	77.5	71.6	
⑦ Female	111	104	74.2	
⑦ Male	111	104	71.6	
⑧ Female	111	104	74.2	
⑧ Male	111	104	71.6	

Accessories



Coding elements
From page 656

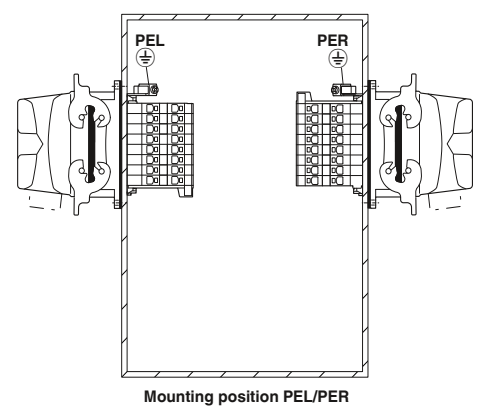

Heavy-duty connectors

HEAVYCON B – contact inserts

BB10, BB18, BB32, BB46 series

500 V, 16 A

Connection technology:

– Push-in connection







To determine the corresponding housing, see the system cross-reference list on page 502.

Notes:
For accessories, see from page 654
Only operate connectors when there is no load/the power is switched off
1) For flexible wires with wire end protection

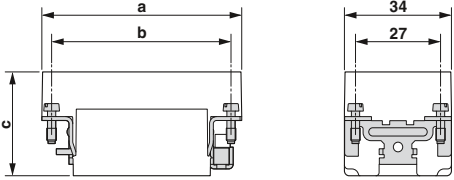
new

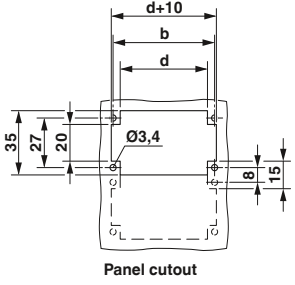

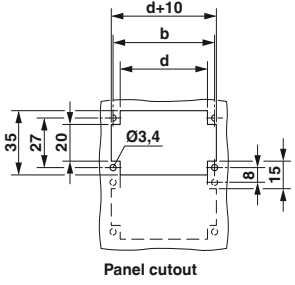
Type	Technical data			
	① HC-BB 10-I-PT-...	② HC-BB 18-I-PT-...	③ HC-BB 32-I-PT-...	④ HC-BB 46-I-PT-...
Approvals	-	-	-	-
IEC data				
Rated current, contacts (at 40°C)	[A] 16	16	16	16
Overtoltage category	III	III	III	III
Degree of pollution	3	3	3	3
Rated voltage (III/3) contacts	[V] 500	500	500	500
Rated surge voltage, contacts	[kV] 6	6	6	6
Connection cross section	[mm ²] 0.34 ... 2.5 ¹⁾	0.34 ... 2.5 ¹⁾	0.34 ... 2.5 ¹⁾	0.34 ... 2.5 ¹⁾
UL data				
Rated voltage	[V] -	-	-	-
Rated current	[A] -	-	-	-
Connection cross section	AWG -	-	-	-
CSA / cUL data				
Rated voltage	[V] -	-	-	-
Rated current	[A] -	-	-	-
Connection cross section	AWG -	-	-	-
Material data				
Contact carrier material	PC	PC	PC	PC
Inflammability class in acc. with UL 94	V0	V0	V0	V0
Contact material	Copper alloy	Copper alloy	Copper alloy	Copper alloy
Contact surface material	Au/Sn	Au/Sn	Au/Sn	Au/Sn
Temperature data				
Ambient temperature range	[°C] -40 ... 125	-40 ... 125	-40 ... 125	-40 ... 125
General data				
Connection method	Push-in connection	Push-in connection	Push-in connection	Push-in connection
Stripping length	[mm] 10	10	10	10
Number of positions	10	18	32	46
Contact numbering	1 - 10	1 - 18	1 - 32	1 - 46
Insertion/withdrawal cycles	≥ 500	≥ 500	≥ 500	≥ 500

Description	Pos.	Number	Size	Type	Ordering data		Pcs./Pkt.	Dimensions (in mm)																																														
					Female	Male		Dimensional drawing																																														
Push-in connection 	10	1 - 10	B6	① HC-BB 10-I-PT...	1014417	1014418	1																																															
Push-in connection 	18	1 - 18	B10	② HC-BB 18-I-PT...	1014419	1014420	1	 <p>Panel cutout</p>																																														
Push-in connection 	32	1 - 32	B16	③ HC-BB 32-I-PT...	1014421	1014422	1	 <p>Panel cutout</p>																																														
Push-in connection 	46	1 - 46	B24	④ HC-BB 46-I-PT...	1014423	1014424	1	<table border="1"> <thead> <tr> <th></th> <th>a</th> <th>b</th> <th>c</th> <th>d</th> </tr> </thead> <tbody> <tr> <td>① Female</td> <td>51</td> <td>44</td> <td>32.5</td> <td>35</td> </tr> <tr> <td>① Male</td> <td></td> <td></td> <td></td> <td></td> </tr> <tr> <td>② Female</td> <td>64</td> <td>57</td> <td>33.2</td> <td>48</td> </tr> <tr> <td>② Male</td> <td></td> <td></td> <td></td> <td></td> </tr> <tr> <td>③ Female</td> <td>84.5</td> <td>77.5</td> <td>33.2</td> <td>68.5</td> </tr> <tr> <td>③ Male</td> <td></td> <td></td> <td></td> <td></td> </tr> <tr> <td>④ Female</td> <td>111</td> <td>104</td> <td>32.5</td> <td>95</td> </tr> <tr> <td>④ Male</td> <td></td> <td></td> <td></td> <td></td> </tr> </tbody> </table>			a	b	c	d	① Female	51	44	32.5	35	① Male					② Female	64	57	33.2	48	② Male					③ Female	84.5	77.5	33.2	68.5	③ Male					④ Female	111	104	32.5	95	④ Male				
	a	b	c	d																																																		
① Female	51	44	32.5	35																																																		
① Male																																																						
② Female	64	57	33.2	48																																																		
② Male																																																						
③ Female	84.5	77.5	33.2	68.5																																																		
③ Male																																																						
④ Female	111	104	32.5	95																																																		
④ Male																																																						

Accessories



Coding profiles
From page 656



Replacement PE screws
From page 662

Heavy-duty connectors

HEAVYCON B – contact inserts

BB10, BB18, BB32, BB46 series

500 V, 16 A

Connection technology:

– Crimp connection

To determine the corresponding housing, see the system cross-reference list on page 502.



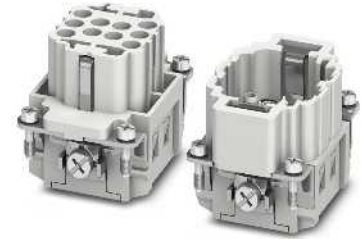



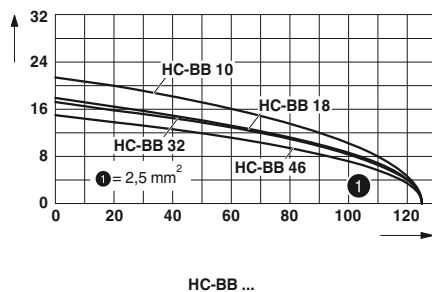

Notes:
For accessories, see from page 654
Order crimp contacts separately
Only operate connectors when there is no load/the power is switched off

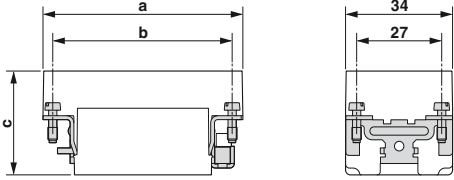

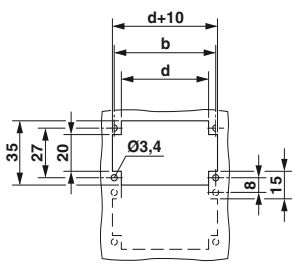
Type	Technical data			
	① HC-BB 10-I-CT-...	② HC-BB 18-I-CT-...	③④ HC-BB 32-I-CT-...	⑤⑥ HC-BB 46-I-CT-...
Approvals	UL ENEC VDE	UL ENEC VDE	UL ENEC VDE	UL ENEC VDE
IEC data				
Rated current, contacts (at 40°C)	[A] 16	16	16	16
Overvoltage category	III	III	III	III
Degree of pollution	3	3	3	3
Rated voltage (III/3) contacts	[V] 500	500	500	500
Rated surge voltage, contacts	[kV] 6	6	6	6
Connection cross section	[mm²] 0.5 ... 4	0.5 ... 4	0.5 ... 4	0.5 ... 4
UL data				
Rated voltage	[V] 600	600	600	600
Rated current	[A] 20	20	16	16
Connection cross section	AWG 12	12	12	12
CSA / cUL data				
Rated voltage	[V] 600	600	600	600
Rated current	[A] 18	16	13.5	13.5
Connection cross section	AWG 12	12	12	12
Material data				
Contact carrier material	PC	PC	PC	PC
Inflammability class in acc. with UL 94	V0	V0	V0	V0
Contact material	Copper alloy	Copper alloy	Copper alloy	Copper alloy
Contact surface material	Ag (alternatively Au)	Ag (alternatively Au)	Ag (alternatively Au)	Ag (alternatively Au)
Temperature data				
Ambient temperature range	[°C] -40 ... 125	-40 ... 125	-40 ... 125	-40 ... 125
General data				
Connection method	Crimp connection	Crimp connection	Crimp connection	Crimp connection
Stripping length	[mm] 7.5	7.5	7.5	7.5
Number of positions	10	18	32	46
Contact numbering	1 - 10	1 - 18	1 - 32	1 - 46
Insertion/withdrawal cycles	≥ 500	≥ 500	≥ 500	≥ 500

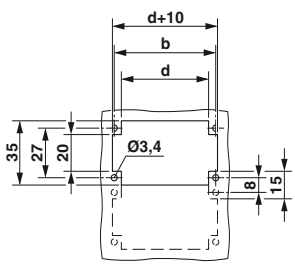
Derating curves



Description	Pos.	Number	Size	Ordering data			Pcs./Pkt.	Dimensions (in mm)																																																																	
				Type	Female	Male																																																																			
Crimp connection																																																																									
	10	1 - 10	B6	① HC-BB 10-I-CT...	1584703	1584774	1																																																																		
Crimp connection																																																																									
	18	1 - 18	B10	② HC-BB 18-I-CT...	1584729	1584716	1	 <p style="text-align: center;">Dimensional drawing</p> <p style="text-align: center;">Panel cutout</p>																																																																	
Crimp connection																																																																									
	32	1 - 32	B16 / B32	③ HC-BB 32-I-CT...	1584745	1584732	1																																																																		
	32	33 - 64	B16 / B32	④ HC-BB 32-I-CT... 33-64	1406543	1406544	1																																																																		
Crimp connection																																																																									
	46	1 - 46	B24 / B48	⑤ HC-BB 46-I-CT...	1584758	1584761	1	<table border="1"> <thead> <tr> <th></th> <th>a</th> <th>b</th> <th>c</th> <th>d</th> </tr> </thead> <tbody> <tr> <td>① Female</td> <td>51</td> <td>44</td> <td>32.5</td> <td>35</td> </tr> <tr> <td>① Male</td> <td></td> <td></td> <td>33.2</td> <td></td> </tr> <tr> <td>② Female</td> <td>64</td> <td>57</td> <td>32.5</td> <td>48</td> </tr> <tr> <td>② Male</td> <td></td> <td></td> <td>33.2</td> <td></td> </tr> <tr> <td>③ Female</td> <td>84.5</td> <td>77.5</td> <td>32.5</td> <td>68.5</td> </tr> <tr> <td>③ Male</td> <td></td> <td></td> <td>33.2</td> <td></td> </tr> <tr> <td>④ Female</td> <td>84.5</td> <td>77.5</td> <td>32.5</td> <td>68.5</td> </tr> <tr> <td>④ Male</td> <td></td> <td></td> <td>33.2</td> <td></td> </tr> <tr> <td>⑤ Female</td> <td>111</td> <td>104</td> <td>32.5</td> <td>95</td> </tr> <tr> <td>⑤ Male</td> <td></td> <td></td> <td>33.2</td> <td></td> </tr> <tr> <td>⑥ Female</td> <td>111</td> <td>104</td> <td>32.5</td> <td>95</td> </tr> <tr> <td>⑥ Male</td> <td></td> <td></td> <td>33.2</td> <td></td> </tr> </tbody> </table>		a	b	c	d	① Female	51	44	32.5	35	① Male			33.2		② Female	64	57	32.5	48	② Male			33.2		③ Female	84.5	77.5	32.5	68.5	③ Male			33.2		④ Female	84.5	77.5	32.5	68.5	④ Male			33.2		⑤ Female	111	104	32.5	95	⑤ Male			33.2		⑥ Female	111	104	32.5	95	⑥ Male			33.2	
	a	b	c	d																																																																					
① Female	51	44	32.5	35																																																																					
① Male			33.2																																																																						
② Female	64	57	32.5	48																																																																					
② Male			33.2																																																																						
③ Female	84.5	77.5	32.5	68.5																																																																					
③ Male			33.2																																																																						
④ Female	84.5	77.5	32.5	68.5																																																																					
④ Male			33.2																																																																						
⑤ Female	111	104	32.5	95																																																																					
⑤ Male			33.2																																																																						
⑥ Female	111	104	32.5	95																																																																					
⑥ Male			33.2																																																																						
	46	47 - 92	B24 / B48	⑥ HC-BB 46-I-CT... 47-92	1406545	1406546	1																																																																		
Turned crimp contacts CK 2,5 Silver-plated			Cross section mm ² / AWG																																																																						
			0.5 - 0.5 / 20	CK2,5-ED-0,50... AG	1663640	1663572	100																																																																		
			0.75 - 0.75 / 18	CK2,5-ED-0,75... AG	1663653	1663585	100																																																																		
			0.75 - 1 / 18	CK2,5-ED-1,00... AG	1663666	1663598	100																																																																		
			1.5 - 1.5 / 16	CK2,5-ED-1,50... AG	1663679	1663608	100																																																																		
			2.5 - 2.5 / 14	CK2,5-ED-2,50... AG	1663682	1663611	100																																																																		
			4 - 4 / 12	CK2,5-ED-4,00... AG	1663705	1663637	100																																																																		
Turned crimp contacts CK 2,5 Gold-plated			Cross section mm ² / AWG																																																																						
			0.5 - 0.5 / 20	CK2,5-ED-0,50... AU	1674859	1674804	100																																																																		
			0.75 - 1 / 18	CK2,5-ED-1,00... AU	1674833	1674781	100																																																																		
			1.5 - 1.5 / 16	CK2,5-ED-1,50... AU	1674820	1674778	100																																																																		
			2.5 - 2.5 / 14	CK2,5-ED-2,50... AU	1674862	1674817	100																																																																		
			4 - 4 / 12	CK2,5-ED-4,00... AU	1674846	1674794	100																																																																		

Accessories



Crimping tools
From page 670



Coding profiles
From page 656



Replacement PE screws
From page 662

Heavy-duty connectors

HEAVYCON B – contact inserts

BBB40, BBB64 series

500 V, 16 A

Connection technology:

– Crimp connection

To determine the corresponding housing, see the system cross-reference list on page 502.

Notes:
For accessories, see from page 654
Order crimp contacts separately
Only operate connectors when there is no load/the power is switched off





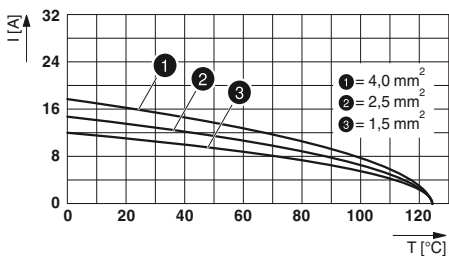

Type	Technical data		
	① HC-BBB 40-E...C	② HC-BBB 64-E...C	
Approvals	ERIC	ERIC	
IEC data			
Rated current, contacts (at 40°C)	[A] 16	16	
Overtoltage category	III	III	
Degree of pollution	3	3	
Rated voltage (III/3) contacts	[V] 500	500	
Rated surge voltage, contacts	[kV] 6	6	
Connection cross section	[mm ²] 0.5 ... 4	0.5 ... 4	
UL data			
Rated voltage	[V] 600	600	
Rated current	[A] 16	16	
Connection cross section	AWG 12	12	
CSA / cUL data			
Rated voltage	[V] -	-	
Rated current	[A] -	-	
Connection cross section	AWG -	-	
Material data			
Contact carrier material	PC	PC	
Inflammability class in acc. with UL 94	V0	V0	
Contact material	Copper alloy	Copper alloy	
Contact surface material	Ag (alternatively Au)	Ag (alternatively Au)	
Temperature data			
Ambient temperature range	[°C] -40 ... 125	-40 ... 125	
General data			
Connection method	Crimp connection	Crimp connection	
Stripping length	[mm] 7.5	7.5	
Number of positions	40	64	
Contact numbering	1 - 40	1 - 64	
Insertion/withdrawal cycles	≥ 500	≥ 500	

Derating curves

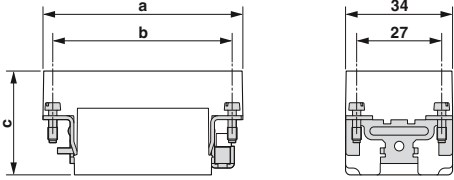

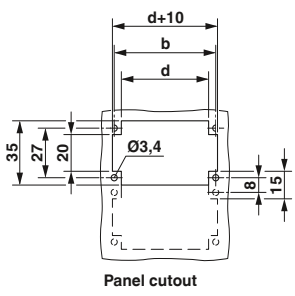
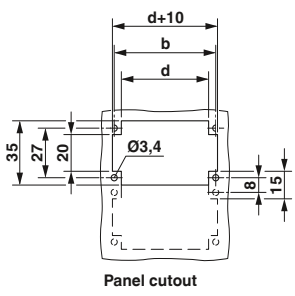
HC-BBB ...

Description	Pos.	Number	Size	Ordering data			Pcs./Pkt.	Dimensions (in mm)																									
				Type	Order No. Female	Order No. Male																											
Crimp connection																																	
	40	1 - 40	B16 / B32	① HC-BBB 40-E...C	1409930	1409921	1																										
Crimp connection																																	
	64	1 - 64	B24 / B48	② HC-BBB 64-E...C	1409914	1409901	1																										
																																	
								<table border="1"> <thead> <tr> <th></th> <th>a</th> <th>b</th> <th>c</th> <th>d</th> </tr> </thead> <tbody> <tr> <td>① Female</td> <td>84</td> <td>77.5</td> <td>37</td> <td>68.5</td> </tr> <tr> <td>① Male</td> <td>84.5</td> <td>77.5</td> <td>34.4</td> <td>68.5</td> </tr> <tr> <td>② Female</td> <td>111</td> <td>104</td> <td>39</td> <td>95</td> </tr> <tr> <td>② Male</td> <td>111</td> <td>104</td> <td>36.4</td> <td>95</td> </tr> </tbody> </table>		a	b	c	d	① Female	84	77.5	37	68.5	① Male	84.5	77.5	34.4	68.5	② Female	111	104	39	95	② Male	111	104	36.4	95
	a	b	c	d																													
① Female	84	77.5	37	68.5																													
① Male	84.5	77.5	34.4	68.5																													
② Female	111	104	39	95																													
② Male	111	104	36.4	95																													
Turned crimp contacts CK 2,5 Silver-plated			Cross section mm² / AWG																														
			0.5 - 0.5 / 20	CK2,5-ED-0,50... AG	1663640	1663572	100																										
			0.75 - 0.75 / 18	CK2,5-ED-0,75... AG	1663653	1663585	100																										
			0.75 - 1 / 18	CK2,5-ED-1,00... AG	1663666	1663598	100																										
			1.5 - 1.5 / 16	CK2,5-ED-1,50... AG	1663679	1663608	100																										
			2.5 - 2.5 / 14	CK2,5-ED-2,50... AG	1663682	1663611	100																										
			4 - 4 / 12	CK2,5-ED-4,00... AG	1663705	1663637	100																										
Turned crimp contacts CK 2,5 Gold-plated			Cross section mm² / AWG																														
			0.5 - 0.5 / 20	CK2,5-ED-0,50... AU	1674859	1674804	100																										
			0.75 - 1 / 18	CK2,5-ED-1,00... AU	1674833	1674781	100																										
			1.5 - 1.5 / 16	CK2,5-ED-1,50... AU	1674820	1674778	100																										
			2.5 - 2.5 / 14	CK2,5-ED-2,50... AU	1674862	1674817	100																										
			4 - 4 / 12	CK2,5-ED-4,00... AU	1674846	1674794	100																										

Accessories



Crimping tools
From page 670



Coding elements
From page 657



Replacement PE screws
From page 662

Heavy-duty connectors

HEAVYCON B – contact inserts

HV03, HV06, HV10 series

High-voltage applications

Push-in connection

830 V, 16 A

Connection technology:



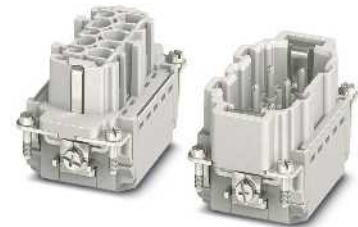

- Push-in connection
- With 2 lagging switch contacts
- For all size B housing

To determine the corresponding housing, see the system cross-reference list on page 502.

Notes:
For accessories, see from page 654
Only operate connectors when there is no load/the power is switched off
1) For flexible wires with wire end protection

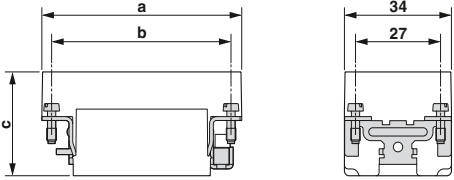

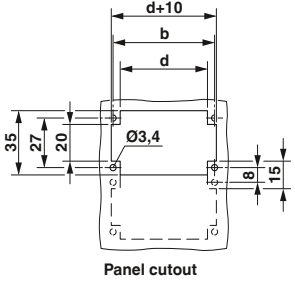
Type	Technical data		
	① HC-HV03-I-PT-...	② HC-HV06-I-PT-...	③ HC-HV10-I-PT-...
Approvals			
IEC data			
Rated current, contacts (at 40°C)	[A] 16	16	16
Overvoltage category	III	III	III
Degree of pollution	3	3	3
Rated voltage (III/3) contacts	[V] 830	830	830
Rated surge voltage, contacts	[kV] 8	8	8
Connection cross section	[mm²] 0.14 ... 2.5 ¹⁾	0.14 ... 2.5 ¹⁾	0.14 ... 2.5 ¹⁾
UL data			
Rated voltage	[V] 600	600	600
Rated current	[A] 21	20	20
Connection cross section	AWG 14	14	14
CSA / cUL data			
Rated voltage	[V] 600	600	600
Rated current	[A] 16	16	15
Connection cross section	AWG 14	14	14
Material data			
Contact carrier material	PC	PC	PC
Inflammability class in acc. with UL 94	V0	V0	V0
Contact material	Copper alloy	Copper alloy	Copper alloy
Contact surface material	-	-	-
Temperature data			
Ambient temperature range	[°C] -40 ... 125	-40 ... 125	-40 ... 125
General data			
Connection method	Push-in connection	Push-in connection	Push-in connection
Stripping length	[mm] 8 ... 10	8 ... 10	8 ... 10
Number of positions	5	8	12
Contact numbering	-	-	-
Insertion/withdrawal cycles	≥ 500	≥ 500	≥ 500

Description	Pos.	Number	Size	Ordering data			Pcs./Pkt.	Dimensions (in mm)
				Type	Order No. Female	Order No. Male		
Push-in connection 	3 / 2		B10	① HC-HV03-I-PT...	1407743	1407739	1	
Push-in connection 	6 / 2		B16 / B32	② HC-HV06-I-PT...	1407744	1407740	1	 <p>Dimensional drawing</p> <p>Panel cutout</p>
Push-in connection 	10 / 2		B24 / B48	③ HC-HV10-I-PT...	1407745	1407741	1	

	a	b	c	d
① Female			34.6	
① Male	64	57	32	49
② Female			34.6	
② Male	84	77.5	32	72
③ Female			34.6	
③ Male	111	104	32	98

Accessories



Coding elements
From page 657



Replacement PE screws
From page 662

Heavy-duty connectors

HEAVYCON B – contact inserts

HV03, HV06, HV10 series

High-voltage applications

Crimp connection

830 V, 25 A

Connection technology:





- Crimp connection
- With 2 lagging switch contacts
- For all size B housing

To determine the corresponding housing, see the system cross-reference list on page 502.

Notes:
For accessories, see from page 654
Order crimp contacts separately
Only operate connectors when there is no load/the power is switched off

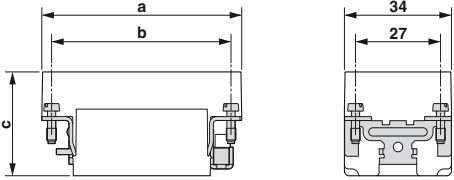
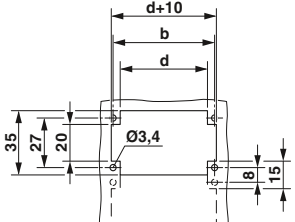

Type	Technical data		
	① HC-HV03-I-CT...	② HC-HV06-I-CT...	③ HC-HV10-I-CT...
Approvals	ERC	ERC	ERC
IEC data			
Rated current, contacts (at 40°C)	[A] 25	25	25
Overvoltage category	III	III	III
Degree of pollution	3	3	3
Rated voltage (III/3) contacts	[V] 830	830	830
Rated surge voltage, contacts	[kV] 8	8	8
Connection cross section	[mm²] 0.5 ... 4	0.5 ... 4	0.5 ... 4
UL data			
Rated voltage	[V] 600	600	600
Rated current	[A] 16	16	16
Connection cross section	AWG 12	12	12
CSA / cUL data			
Rated voltage	[V] -	-	-
Rated current	[A] -	-	-
Connection cross section	AWG -	-	-
Material data			
Contact carrier material	PA	PA	PA
Inflammability class in acc. with UL 94	V0	V0	V0
Contact material	Copper alloy	Copper alloy	Copper alloy
Contact surface material	Ag (alternatively Au)	Ag (alternatively Au)	Ag (alternatively Au)
Temperature data			
Ambient temperature range	[°C] -40 ... 125	-40 ... 125	-40 ... 125
General data			
Connection method	Crimp connection	Crimp connection	Crimp connection
Stripping length	[mm] 7.5	7.5	7.5
Number of positions	5	8	12
Contact numbering	-	-	-
Insertion/withdrawal cycles	≥ 500	≥ 500	≥ 500

Description	Pos.	Number	Size	Ordering data			Pcs./ Pkt.	Dimensions (in mm)																																		
				Type	Female	Male																																				
Crimp connection 	3 / 2		B10	① HC-HV03-I-CT...	1405261	1405260	1	 <p>Dimensional drawing</p>  <p>Panel cutout</p>																																		
Crimp connection 	6 / 2		B16 / B32	② HC-HV06-I-CT...	1405263	1405262	1																																			
Crimp connection 	10 / 2		B24 / B48	③ HC-HV10-I-CT...	1405265	1405264	1																																			
<table border="1"> <thead> <tr> <th></th> <th>a</th> <th>b</th> <th>c</th> <th>d</th> </tr> </thead> <tbody> <tr> <td>① Female</td> <td>64</td> <td>57</td> <td>34.6</td> <td>49</td> </tr> <tr> <td>① Male</td> <td></td> <td></td> <td>32</td> <td></td> </tr> <tr> <td>② Female</td> <td>84</td> <td>77.5</td> <td>34.6</td> <td>72</td> </tr> <tr> <td>② Male</td> <td></td> <td></td> <td>32</td> <td></td> </tr> <tr> <td>③ Female</td> <td>111</td> <td>104</td> <td>34.6</td> <td>98</td> </tr> <tr> <td>③ Male</td> <td></td> <td></td> <td>32</td> <td></td> </tr> </tbody> </table>									a	b	c	d	① Female	64	57	34.6	49	① Male			32		② Female	84	77.5	34.6	72	② Male			32		③ Female	111	104	34.6	98	③ Male			32	
	a	b	c	d																																						
① Female	64	57	34.6	49																																						
① Male			32																																							
② Female	84	77.5	34.6	72																																						
② Male			32																																							
③ Female	111	104	34.6	98																																						
③ Male			32																																							
Turned crimp contacts CK 2,5 Silver-plated 			Cross section mm ² / AWG 0.5 - 0.5 / 20 0.75 - 0.75 / 18 0.75 - 1 / 18 1.5 - 1.5 / 16 2.5 - 2.5 / 14 4 - 4 / 12	CK2,5-ED-0,50... AG CK2,5-ED-0,75... AG CK2,5-ED-1,00... AG CK2,5-ED-1,50... AG CK2,5-ED-2,50... AG CK2,5-ED-4,00... AG	1663640 1663653 1663666 1663679 1663682 1663705	1663572 1663585 1663598 1663608 1663611 1663637	100 100 100 100 100 100																																			
Turned switch contacts CK 2,5 Male, silver-plated 			Cross section mm ² / AWG 1 - 1 / 18 1.5 - 1.5 / 16 2.5 - 2.5 / 14	CK2,5-ED-1,00ST-S AG CK2,5-ED-1,50ST-S AG CK2,5-ED-2,50ST-S AG		1663857 1663860 1663873																																				

Accessories



Crimping tools
From page 670



Coding elements
From page 657



Replacement PE screws
From page 662

Heavy-duty connectors

HEAVYCON B – contact inserts

HS series

High-current applications

400 V / 690 V, 41 A
1000 V, 80 A

Connection technology:

– Screw connection

To determine the corresponding housing, see the system cross-reference list on page 502.

Notes:
For accessories, see from page 654
Only operate connectors when there is no load/the power is switched off
For assembly instructions, see phoenixcontact.net/products
¹⁾ For rigid conductors and flexible wires with wire end protection



Type	Technical data	
	① ② HC-HS06-I-UT...	③ HC-K 6/0-E...S
Approvals	UL ENEC VDE	UL ENEC VDE
IEC data		
Rated current, contacts (at 40°C)	[A] 41	80
Overvoltage category	III	III
Degree of pollution	3	3
Rated voltage (III/3) contacts	[V] 400 / 690	1000
Rated surge voltage, contacts	[kV] 6	8
Connection cross section	[mm ²] 0.5 ... 6	6 ... 16
UL data		
Rated voltage	[V] 600	600
Rated current	[A] 35	80
Connection cross section	AWG 10	6
CSA / cUL data		
Rated voltage	[V] 600	600
Rated current	[A] 32	60
Connection cross section	AWG 10	10-6
Material data		
Contact carrier material	PC	PA
Inflammability class in acc. with UL 94	V0	V0
Contact material	Copper alloy	Copper alloy
Contact surface material	Ag	Ag
Temperature data		
Ambient temperature range	[°C] -40 ... 125	-40 ... 125
General data		
Connection method	Screw connection	Screw connection
Stripping length	[mm] 10	15
Number of positions	6	6
Contact numbering	1 - 6	1 - 6
Insertion/withdrawal cycles	≥ 500	≥ 500

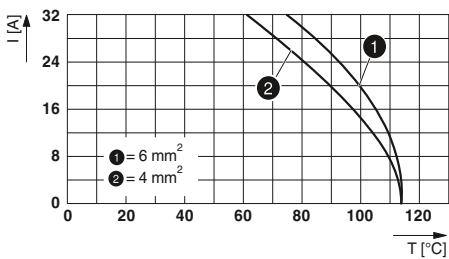

Derating curves

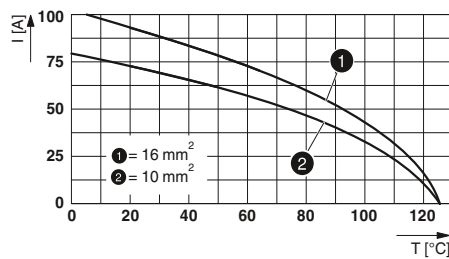

HC-HS06-I-UT...

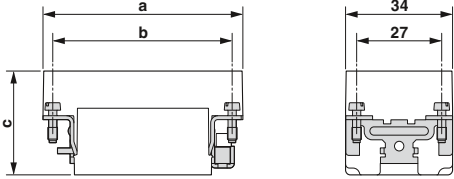

HC-K 6/0-E...S

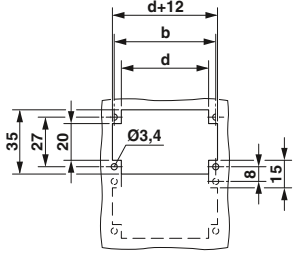
Description	Pos.	Number	Size	Type	Ordering data		Pcs./Pkt.	Dimensions (in mm)																																			
					Female	Male																																					
Screw connection 	6	1 - 6	B16 / B32	① HC-HS06-I-UT...	1406530	1406531	1																																				
	6	7 - 12	B16 / B32	② HC-HS06-I-UT... 7-12	1406533	1406534	1																																				
Screw connection¹⁾ 	6	1 - 6	B16 / B32	③ HC-K 6/0-E...S	1580537	1580538	10	 Dimensional drawing Panel cutout																																			
								<table border="1"> <thead> <tr> <th></th> <th>a</th> <th>b</th> <th>c</th> <th>d</th> </tr> </thead> <tbody> <tr> <td>① Female</td> <td>84.5</td> <td>77.5</td> <td>34</td> <td>72</td> </tr> <tr> <td>① Male</td> <td></td> <td></td> <td></td> <td></td> </tr> <tr> <td>② Female</td> <td>84.5</td> <td>77.5</td> <td>34</td> <td>72</td> </tr> <tr> <td>② Male</td> <td></td> <td></td> <td></td> <td></td> </tr> <tr> <td>③ Female</td> <td>84</td> <td>77.4</td> <td>49.7</td> <td>72</td> </tr> <tr> <td>③ Male</td> <td></td> <td></td> <td>46.3</td> <td></td> </tr> </tbody> </table>		a	b	c	d	① Female	84.5	77.5	34	72	① Male					② Female	84.5	77.5	34	72	② Male					③ Female	84	77.4	49.7	72	③ Male			46.3	
	a	b	c	d																																							
① Female	84.5	77.5	34	72																																							
① Male																																											
② Female	84.5	77.5	34	72																																							
② Male																																											
③ Female	84	77.4	49.7	72																																							
③ Male			46.3																																								

Accessories



Coding profiles
From page 656



Replacement PE screws
From page 662

Heavy-duty connectors

HEAVYCON B – contact inserts

K series

Combination applications for power and signal

400 V ... 830 V, 40 A ... 80 A

Connection technology:

- Power and control contacts
- Screw connection

To determine the corresponding housing, see the system cross-reference list on page 502.

Notes:
For accessories, see from page 654
Only operate connectors when there is no load/the power is switched off
1) For rigid conductors and flexible wires with wire end protection



Type	Technical data					
	① HC-K 4/0-E...S		② HC-K 4/2-E...S		③ HC-K 4/8-E...S	
	Power contacts	Control contacts	Power contacts	Control contacts	Power contacts	Control contacts
Approvals	EAC		EAC		EAC	
IEC data						
Rated current [A]	80	-	-	-	80	16
Overvoltage category		III		III		III
Degree of pollution		3		3		3
Rated voltage (III/3) contacts [V]	830	-	-	-	400	400
Rated surge voltage, contacts [kV]	8	-	-	-	6	6
Connection cross section [mm ²]	1.5 ... 16	-	-	-	1.5 ... 16	0.5 ... 2.5
UL data						
Rated voltage [V]	600	-	600	-	600	-
Rated current [A]	80	-	16	-	16	-
Connection cross section AWG	6	-	14	-	14	-
CSA / cUL data						
Rated voltage [V]	-	-	-	-	-	-
Rated current [A]	-	-	-	-	-	-
Connection cross section AWG	-	-	-	-	-	-
Material data						
Contact carrier material	PC		PC		PA	
Inflammability class in acc. with UL 94	V0		V0		V0	
Contact material	Cu alloy		Cu alloy		Copper alloy	
Contact surface material	Ag	-	Ag	Ag	Ag	Ag
Temperature data						
Ambient temperature range [°C]	-40 ... 125		-40 ... 125		-40 ... 125	
General data						
Connection method	Screw connection		-		Screw connection	
Hexagonal socket [mm]	-		-		-	
Stripping length [mm]	-		-		-	
Number of positions	4	0	4	2	4	8
Contact numbering	1 - 4	-	-	-	1 - 4	1 - 8
Insertion/withdrawal cycles	≥ 500		≥ 500		≥ 500	

Derating curves

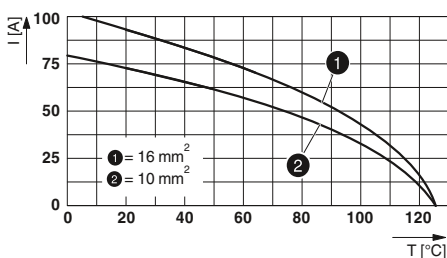



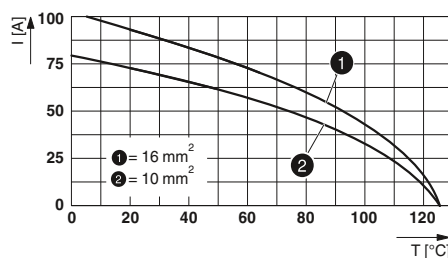

HC-K 4/0-E...S

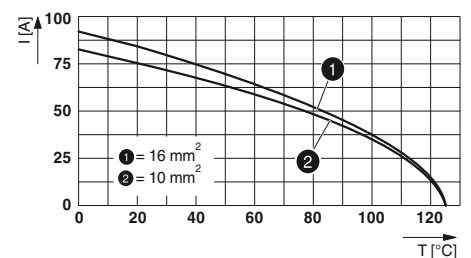

HC-K 4/2-E...S

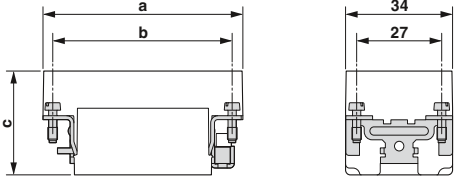

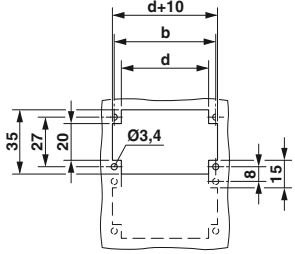
HC-K 4/8-E...S

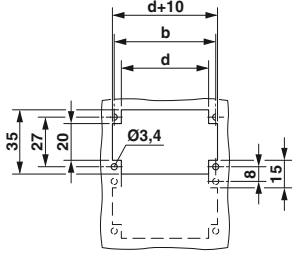
Description	Pos.	Number	Size	Type	Ordering data		Pcs./Pkt.	Dimensions (in mm)																																			
					Female	Male																																					
Screw connection ¹⁾ 	4 / 0	1 - 4	B16 / B32	① HC-K 4/0-E...S	1679427	1679414	1																																				
Screw connection ¹⁾ 	4 / 2	1 - 4	B16 / B32	② HC-K 4/2-E...S	1686876	1686889	1	Dimensional drawing 																																			
Screw connection ¹⁾ 	4 / 8	1 - 4	B24 / B48	③ HC-K 4/8-E...S	1679320	1679333	1	Panel cutout 																																			
								<table border="1"> <thead> <tr> <th></th> <th>a</th> <th>b</th> <th>c</th> <th>d</th> </tr> </thead> <tbody> <tr> <td>① Female</td> <td></td> <td></td> <td>44.2</td> <td></td> </tr> <tr> <td>① Male</td> <td>84.5</td> <td>77.5</td> <td>42</td> <td>72</td> </tr> <tr> <td>② Female</td> <td></td> <td></td> <td>44.2</td> <td></td> </tr> <tr> <td>② Male</td> <td>84.5</td> <td>77.5</td> <td>42</td> <td></td> </tr> <tr> <td>③ Female</td> <td></td> <td></td> <td>44.2</td> <td></td> </tr> <tr> <td>③ Male</td> <td>111</td> <td>104</td> <td>42</td> <td>98</td> </tr> </tbody> </table>		a	b	c	d	① Female			44.2		① Male	84.5	77.5	42	72	② Female			44.2		② Male	84.5	77.5	42		③ Female			44.2		③ Male	111	104	42	98
	a	b	c	d																																							
① Female			44.2																																								
① Male	84.5	77.5	42	72																																							
② Female			44.2																																								
② Male	84.5	77.5	42																																								
③ Female			44.2																																								
③ Male	111	104	42	98																																							

Accessories



Coding elements
From page 657



Replacement PE screws
From page 662

Heavy-duty connectors

HEAVYCON B – contact inserts

K series

Combination applications for power and signal

690 V, 40 A

Connection technology:

- Power and control contacts
- Screw connection

To determine the corresponding housing, see the system cross-reference list on page 502.

Notes:
For accessories, see from page 654
Only operate connectors when there is no load/the power is switched off



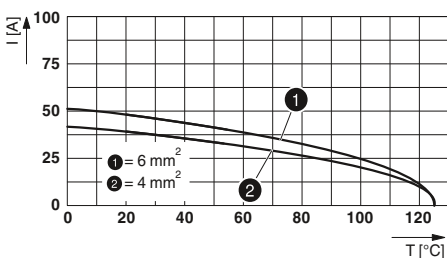

Type	Technical data			
	① HC-K 6/6-E...S		② HC-K 6/12-E...S	
	Power contacts	Control contacts	Power contacts	Control contacts
Approvals	UL		UL	
IEC data				
Rated current [A]	-	-	40	10
Overvoltage category	-	III	-	III
Degree of pollution	-	3	-	3
Rated voltage (III/3) contacts [V]	-	-	690	230 / 400
Rated surge voltage, contacts [kV]	-	-	8	4
Connection cross section [mm ²]	-	-	2.5 ... 8	0.2 ... 2.5
UL data				
Rated voltage [V]	600	-	-	-
Rated current [A]	16	-	-	-
Connection cross section AWG	14	-	-	-
CSA / cUL data				
Rated voltage [V]	-	-	-	-
Rated current [A]	-	-	-	-
Connection cross section AWG	-	-	-	-
Material data				
Contact carrier material	PC		PC	
Inflammability class in acc. with UL 94	V0		V0	
Contact material	Cu alloy		Cu alloy	
Contact surface material	Ag	Ag	Ag	Ag
Temperature data				
Ambient temperature range [°C]	-40 ... 125		-40 ... 125	
General data				
Connection method	-	-	Axial screw connection	Screw connection
Hexagonal socket [mm]	-	-	2	-
Stripping length [mm]	-	-	8	10
Number of positions	6	6	6	12
Contact numbering	-	-	1 - 6	11 - 22
Insertion/withdrawal cycles	≥ 500		≥ 500	

Derating curves

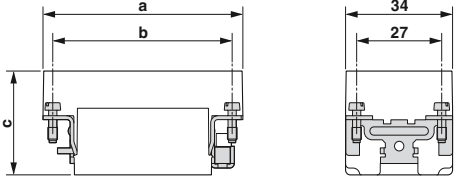

HC-K 6/12-E...S

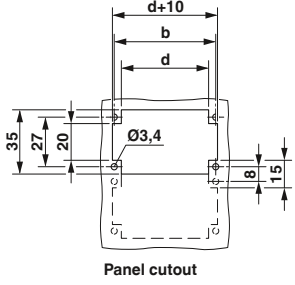
Description	Pos.	Number	Size	Type	Ordering data		Pcs./Pkt.	Dimensions (in mm)																									
					Female	Male																											
Axial screw connection 	6 / 6	1 - 6	B24 / B48	① HC-K 6/6-E...S	1636402	1636392	1																										
Axial screw connection 	6 / 12	1 - 6	B16 / B32	② HC-K 6/12-E...S	1636363	1636350	1	 <p style="text-align: center;">Panel cutout</p>																									
								<table border="1"> <thead> <tr> <th></th> <th>a</th> <th>b</th> <th>c</th> <th>d</th> </tr> </thead> <tbody> <tr> <td>① Female</td> <td></td> <td></td> <td></td> <td></td> </tr> <tr> <td>① Male</td> <td></td> <td></td> <td></td> <td></td> </tr> <tr> <td>② Female</td> <td>84.1</td> <td>77.5</td> <td>47</td> <td>68.5</td> </tr> <tr> <td>② Male</td> <td>84.5</td> <td></td> <td>47.2</td> <td></td> </tr> </tbody> </table>		a	b	c	d	① Female					① Male					② Female	84.1	77.5	47	68.5	② Male	84.5		47.2	
	a	b	c	d																													
① Female																																	
① Male																																	
② Female	84.1	77.5	47	68.5																													
② Male	84.5		47.2																														

Accessories



Coding elements
From page 657



Replacement PE screws
From page 662

Heavy-duty connectors

HEAVYCON B – contact inserts

K series

Combination applications for power and signal

230 V / 400 V ... 690 V, 16 A ... 40 A

Connection technology:

- Power and control contacts
- Crimp connection

To determine the corresponding housing, see the system cross-reference list on page 502.

Notes:
For accessories, see from page 654
Order crimp contacts separately
Only operate connectors when there is no load/the power is switched off



Type	Technical data					
	① HC-K 6/36-E...C		② HC-K12/ 2-E...C		③ HC-K 8/24-E...C	
	Power contacts	Control contacts	Power contacts	Control contacts	Power contacts	Control contacts
Approvals	UL		UL		UL	
IEC data						
Rated current [A]	40	10	40	10	16	10
Overvoltage category	III		III		III	
Degree of pollution	3		3		3	
Rated voltage (III/3) contacts [V]	690	160	690	250	230 / 400	160
Rated surge voltage, contacts [kV]	8	2.5	8	4	4	2.5
Connection cross section [mm ²]	1.5 ... 6	0.14 ... 2.5	1.5 ... 6	0.14 ... 2.5	0.5 ... 4	0.14 ... 2.5
UL data						
Rated voltage [V]	600	-	600	-	600	-
Rated current [A]	10	-	10	-	10	-
Connection cross section AWG	14	-	14	-	14	-
CSA / cUL data						
Rated voltage [V]	-	-	-	-	-	-
Rated current [A]	-	-	-	-	-	-
Connection cross section AWG	-	-	-	-	-	-
Material data						
Contact carrier material	PC		PC		PA	
Inflammability class in acc. with UL 94	V0		V0		V0	
Contact material	Cu alloy		Cu alloy		Cu alloy	
Contact surface material	Ag	Ag (alternatively Au)	Ag	Ag (alternatively Au)	Ag (alternat. Au)	Ag (alternatively Au)
Temperature data						
Ambient temperature range [°C]	-40 ... 125		-40 ... 125		-40 ... 125	
General data						
Connection method	Crimp connection	Crimp connection	Crimp connection	Crimp connection	Crimp connection	Crimp connection
Stripping length [mm]	9	8	9	8	7.5	8
Number of positions	6	36	12	2	8	24
Contact numbering	1 - 6	1 - 36	1 - 12	1 - 2	1 - 8	1 - 24
Insertion/withdrawal cycles	≥ 500		≥ 500		≥ 500	

Derating curves

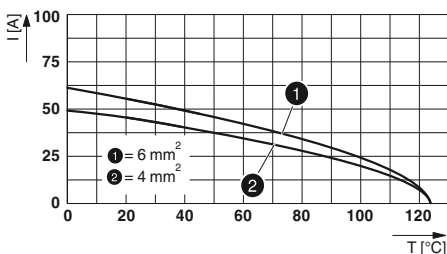



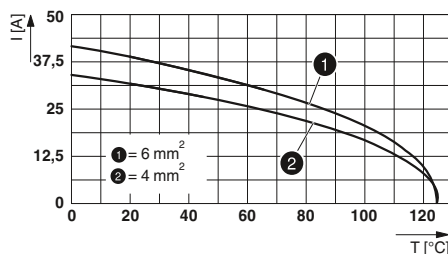

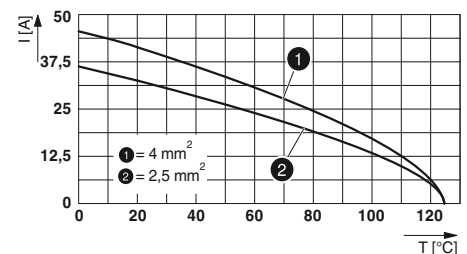

HC-K 6/36 E...C

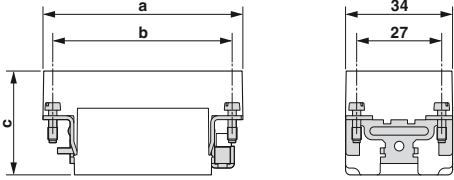
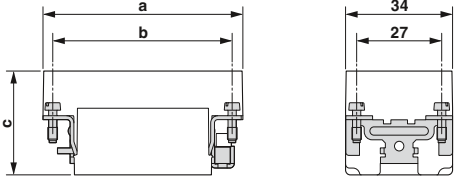
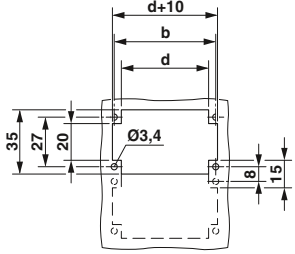

HC-K 12/2 E...C



HC-K 8/24 E...C

				Ordering data			Dimensions (in mm)				
Description	Pos.	Number	Size	Type	Order No.		Pcs./Pkt.				
					Female	Male					
Crimp connection CK 4,0/CK 1,6								 <p>Dimensional drawing</p>  <p>Panel cutout</p>			
	6 / 36	1 - 6	B16 / B32	① HC-K 6/36-E...C	1663389	1663376	1				
Crimp connection CK 4,0/CK 1,6											
	12 / 2	1 - 12	B16 / B32	② HC-K12/ 2-E...C	1663347	1663334	1				
Crimp connection CK 2,5/CK 1,6											
	8 / 24	1 - 8	B10	③ HC-K 8/24-E...C	1663321	1663318	1				
Turned crimp contacts CK 1,6 Silver-plated											
			Cross section mm² / AWG								
			0.14 - 0.37 / 26 - 22	CK1,6-ED-0,37... AG	1663394	1663336	100				
			0.5 - 0.5 / 20	CK1,6-ED-0,50... AG	1663404	1663349	100				
			0.75 - 0.75 / 18	CK1,6-ED-0,75... AG	1663417	1663352	100				
			0.75 - 1 / 18	CK1,6-ED-1,00... AG	1663420	1663365	100				
			1.5 - 1.5 / 16	CK1,6-ED-1,50... AG	1663433	1663378	100				
			2.5 - 2.5 / 14	CK1,6-ED-2,50... AG	1663446	1663381	100				
Turned crimp contacts CK 2,5 Silver-plated											
			Cross section mm² / AWG								
			0.5 - 0.5 / 20	CK2,5-ED-0,50... AG	1663640	1663572	100				
			0.75 - 0.75 / 18	CK2,5-ED-0,75... AG	1663653	1663585	100				
			0.75 - 1 / 18	CK2,5-ED-1,00... AG	1663666	1663598	100				
			1.5 - 1.5 / 16	CK2,5-ED-1,50... AG	1663679	1663608	100				
			2.5 - 2.5 / 14	CK2,5-ED-2,50... AG	1663682	1663611	100				
			4 - 4 / 12	CK2,5-ED-4,00... AG	1663705	1663637	100				
Turned crimp contacts CK 4,0 Silver-plated											
			Cross section mm² / AWG								
			1.5 - 1.5 / 16	CK4,0-ED-1,50... AG	1663271	1663239	25				
			2.5 - 2.5 / 14	CK4,0-ED-2,50... AG	1663284	1663242	25				
			4 - 4 / 12	CK4,0-ED-4,00... AG	1663297	1663255	25				
			6 - 6 / 10	CK4,0-ED-6,00... AG	1663307	1663268	25				
			10 - 10 / 8	CK4,0-ED-10,00... AG	1586183	1586198	25				

	a	b	c	d
① Female	84.5	77.5	41.5	68.5
① Male			39	
② Female	84.5	77.5	41.5	72
② Male			39.6	
③ Female	64	57	38	49
③ Male			36	

Accessories



Crimping tools
From page 670



Coding elements
From page 657

























Crimp contacts, gold-plated
From page 666



Replacement PE screws
From page 662

Heavy-duty connectors

HEAVYCON B – contact inserts

Power					
TYPE	HC-M-01-AT...-40	HC-M-01-AT...-40-PE	HC-M-02-AT...-35	HC-M-02-AT...-16	HC-M-02-AT...-10
					
Connection technology	Axial screw	Axial screw	Axial screw	Axial screw	Axial screw
Number of positions	1	1	2	2	2
IEC rated data	200 A, 1000 V, 70 mm ²	PE, 70 mm ²	100 A, 1000 V, 35 mm ²	70 A, 1000 V, 25 mm ²	40 A, 1000 V, 10 mm ²
UL rated data	146 A, 600 V, AWG 00	PE, AWG 00	127 A, 600 V, AWG 2	69 A, 600 V, AWG 6	55 A, 600 V, AWG 8
Module slots	2	2	2	1	1
Page	572	572	572	572	572
TYPE	HC-M-02-CT...	HC-M-03-CT...	HC-M-03/04-CT...	HC-M-04-CT...	HC-M-02-CT...-HV-16
					
Connection technology	Crimp connection CK 4,0	Crimp connection CK 4,0	Crimp connection CK 4,0 / CK 1,6	Crimp connection CK 4,0	Crimp connection CK 2,5
Number of positions	2	3	3 / 4	4	2
IEC rated data	40 A, 1000 V, 10 mm ²	40 A, 690 V, 10 mm ²	40 / 10 A, 830 V, 6 / 2.5 mm ²	40 A, 830 V, 6 mm ²	16 A, 2900 / 5000 V, 4 mm ²
UL rated data	42 A, 600 V, AWG 10	42 A, 600 V, AWG 10	40 A, 600 A, AWG 10	37 A, 600 V, AWG 10	28 A, 600 V, AWG 12
Module slots	1	1	1	1	2
Page	574	574	574	574	578
TYPE	HC-M-05-PT...	HC-M-05L-TPT...	HC-M-06P-CT...	HC-M-06-PT...	HC-M-06-CT...
					
Connection technology	Push-in connection	Push-in double connection	Crimp connection CK 2,5	Push-in connection	Crimp connection CK 2,5
Number of positions	5	5	6	6	6
IEC rated data	16 A, 400 V, 2.5 mm ²	10 A, 230 / 400 V, 1.5 mm ²	16 A, 830 V, 4 mm ²	16 A, 500 V, 2.5 mm ²	16 A, 500 V, 4 mm ²
UL rated data	19 A, 600 V, AWG 14	16 A, 600 V, AWG 16	24 A; 600 V; AWG 12	-	24 A, 600 V, AWG 12
Module slots	1	1	1	1	1
Page	576	576	578	576	578
TYPE	HC-M-08-PT...	HC-M-08-CT...		HC-M-20-CT...	
					
Connection technology	Push-in connection	Crimp connection CK 2,5		Crimp connection CK 2,5	
Number of positions	8	8		20	
IEC rated data	16 A, 400 V, 2.5 mm ²	16 A, 400 V, 4 mm ²		16 A, 500 V, 4 mm ²	
UL rated data	-	20 A, 600 V, AWG 12		17.5 A, 600 V, AWG 12	
Module slots	1	1		2	
Page	576	578		578	
Signal					
TYPE	HC-M-12-PT...	HC-M-12-CT...	HC-M-17-CT...	HC-M-25-CT...	
					
Connection technology	Push-in connection	Crimp connection CK 1,6	Crimp connection CK 1,6	Crimp connection VS 1,0	
Number of positions	12	12	17	25	
IEC rated data	10 A, 250 V, 1.5 mm ²	10 A, 250 V, 2.5 mm ²	10 A, 160 V, 2.5 mm ²	4 A, 50 V, 0.5 mm ²	
UL rated data	-	16 A, 600 V, AWG 14	14 A, 600 V, AWG 14	5 A, 30 V, AWG 20	
Module slots	1	1	1	1	
Page	576	580	580	586	

Data						
TYPE	HC-M-DSUB 09-CT...	HC-M-DSUB 09-UT...	HC-M-08-GBIT-CT...	HC-M-04-KT...	HC-M-04-...-KOAX...	
Connection technology	Crimp connection VS 1,0	Screw connection	Crimp connection VS 1,0	For coaxial crimp contacts	Coaxial crimp contacts	
Data transmission rate	-	12 Mbps, PROFIBUS	10 Gbps, CAT 6 _A	-	≥ 2 GHz	
IEC rated data	1 A, 50 V, 0.5 mm ²	1 A, 50 V, 0.5 mm ²	5 A, 50 V, 0.5 mm ²	-	75 Ω 50 Ω	
UL rated data	-	-	5 A, 30 V, AWG 20	-	-	
Number of positions / module slots	9 / 1	9 / 1	8 / 1	4 / 1	-	
Page	586	586	586	588	588	

TYPE	HC-M-02-EMC...	HC-M-EMC-DSUB...	HC-M-EMV...	HC-M01-COAX-1,6...	HC-M01-COAX-1,6...
Connection technology	EMC connector	Crimp connection VS 1,0	Crimp connection CK 1,6	Crimp connection CK 1,6	Crimp connection CK 2,5
Data transmission rate	-	100 Mbps, CAT 5e	100 Mbps, CAT 5e	500 MHz, 75 Ω coaxial	500 MHz, 50 Ω coaxial
IEC rated data	-	5 A, 50 V, 0.52 mm ²	10 A, 50 V, 2.5 mm ²	10 A, 50 V	16 A, 50 V
UL rated data	-	5 A, 30 V, AWG 20	10 A, 30 V, AWG 16	10 A, 30 V	16 A, 30 V
Number of positions / module slots	2 / 2	8 / -	4 / -	1 / -	1 / -
Page	582	582	582	584	584

TYPE	HC-M-RJ45-08-GC...	HC-M-RJ45...	HC-M-RJI-AD-PC...	CUC-INI-C1ZNI-S/R4IE8	CUC-INI-C1ZNI-S/R4IP8
Connection technology	RJ45 gender changer	RJ45, crimp connection		RJ Industrial, IDC	
Data transmission rate	10 Gbps, 500 MHz	10 Gbps, 500 MHz		1 Gbps, 100 MHz	1 Gbps, 100 MHz
Description	CAT 6 _A	CAT 6 _A	For RJ Industrial, IDC	CAT 5e	CAT 5e
Number of positions	8	-	-	-	-
Module slots	1	1	1	AWG 26-24	AWG 23-22
Page	590	590	590	590	590

TYPE	HC-M-RJ45...	NBC-R4AC1/1,0-94G/R4AC1-BU	FL CAT6 PATCH 1,0	FL CAT5 PATCH 1,0	
Connection technology		RJ45 patch cable			
Data transmission rate		10 Gbps, 500 MHz	1 Gbps, 250 MHz	1 Gbps, 100 MHz	
Description	For RJ45 patch cables	CAT 6 _A patch cable	CAT 6 patch cable	CAT 5e patch cable	
Number of positions	-	-	-	-	
Module slots	1	-	-	-	
Page	590	590	590	590	

Pneumatics							Dummy module
TYPE	HC-M-02-PN-M...	HC-M-PN2...	HC-M-03-PN-M...	HC-M-PN3...			HC-M-00
Hose internal diameter	6 mm	6 mm	1.6 mm	1.6 mm	3 mm	4 mm	
Number of positions	2	-	3	-	-	-	
Module slots	1	-	1	-	-	-	1
Page	592	592	592	592	592	592	594

Heavy-duty connectors

HEAVYCON B – contact inserts

Modular contact inserts

1000 V, 40 A ... 200 A

Connection technology:
– Axial screw connection

To determine the corresponding housing, see the system cross-reference list on page 502.

Notes:
For accessories, see from page 654
Only operate connectors when there is no load/the power is switched off
1) For a housing height of ≥ 72 mm only



Type	Technical data				
	① HC-M-01-AT...-40	② HC-M-01-AT...-40-PE PE module	③ HC-M-02-AT...-35	④ HC-M-02-AT...-16	⑤ HC-M-02-AT...-10
Approvals					
IEC data					
Rated current, contacts (at 40°C)	[A] 200	-	100	70	40
Overtoltage category	III	-	III	III	III
Degree of pollution	3	-	3	3	3
Rated voltage (III/3) contacts	[V] 1000	-	1000	1000	1000
Rated surge voltage, contacts	[kV] 8	-	8	8	8
Connection cross section	[mm ²] 25 ... 70	25 ... 70	10 ... 35	1.5 ... 25	2.5 ... 10
UL data					
Rated voltage	[V] 600	-	600	600	600
Rated current	[A] 146	-	127	69	55
Connection cross section	AWG 0	-	2	6	8
CSA / cUL data					
Rated voltage	[V] 600	-	600	600	600
Rated current	[A] 116	-	100	54	45
Connection cross section	AWG 0	-	2	6	8
Material data					
Contact carrier material	PC	PC	PC	PC	PC
Inflammability class in acc. with UL 94	V0	V0	V0	V0	V0
Contact material	Copper alloy	Copper alloy	Copper alloy	Copper alloy	Copper alloy
Contact surface material	Ag	Ag	Ag	Ag	Ag
Ambient conditions					
Ambient temperature range	[°C] -40 ... 125	-40 ... 125	-40 ... 125	-40 ... 125	-40 ... 125
General data					
Connection method	Axial screw connection	Axial screw connection	Axial screw connection	Axial screw connection	Axial screw connection
Hexagonal socket	[mm] 5	5	4	2.5	2
Stripping length	[mm] 16	16	13	11	5
Number of positions	1	1	2	2	2
Contact numbering	-	-	1 - 2	1 - 2	1 - 2
Insertion/withdrawal cycles	≥ 500	≥ 500	≥ 500	≥ 500	≥ 500

Derating curves

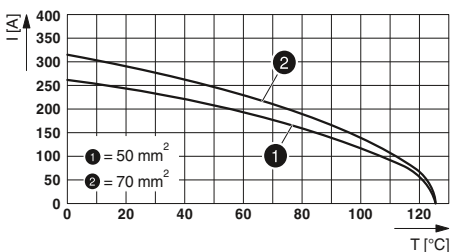



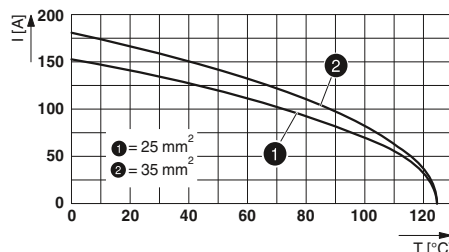

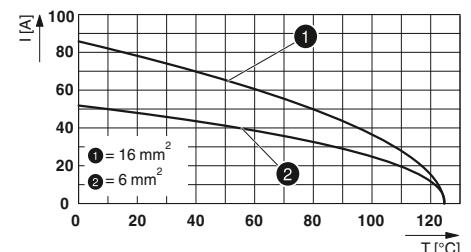

HC-M-01-AT...-40



HC-M-02-AT...-35



HC-M-02-AT...-16

Description	Pos.	Number	Slots	Ordering data			Pcs./Pkt.	Dimensions (in mm)																																																							
				Type	Order No. Female	Order No. Male																																																									
Axial screw connection ¹⁾	1		2	① HC-M-01-AT-...-40	1417379	1417381	2																																																								
																																																															
Axial screw connection ¹⁾	1		2	PE module ② HC-M-01-AT-...-40-PE	1417380	1417382	2	1 module slot																																																							
																																																															
Axial screw connection ¹⁾	2	1 - 2	2	③ HC-M-02-AT-...-35	1417390	1417392	2		2 module slots																																																						
								<table border="1"> <thead> <tr> <th></th> <th>a</th> <th>b</th> <th>c</th> <th>d</th> </tr> </thead> <tbody> <tr> <td>① Female</td> <td></td> <td></td> <td>60</td> <td></td> </tr> <tr> <td>① Male</td> <td></td> <td></td> <td>54.5</td> <td></td> </tr> <tr> <td>② Female</td> <td></td> <td></td> <td>54.3</td> <td></td> </tr> <tr> <td>② Male</td> <td></td> <td></td> <td>54.6</td> <td></td> </tr> <tr> <td>③ Female</td> <td></td> <td></td> <td>50.3</td> <td></td> </tr> <tr> <td>③ Male</td> <td></td> <td></td> <td>49</td> <td></td> </tr> <tr> <td>④ Female</td> <td></td> <td></td> <td>46.5</td> <td></td> </tr> <tr> <td>④ Male</td> <td></td> <td></td> <td>45</td> <td></td> </tr> <tr> <td>⑤ Female</td> <td></td> <td></td> <td>33.5</td> <td></td> </tr> <tr> <td>⑤ Male</td> <td></td> <td></td> <td>34.7</td> <td></td> </tr> </tbody> </table>		a	b	c	d	① Female			60		① Male			54.5		② Female			54.3		② Male			54.6		③ Female			50.3		③ Male			49		④ Female			46.5		④ Male			45		⑤ Female			33.5		⑤ Male			34.7	
	a	b	c	d																																																											
① Female			60																																																												
① Male			54.5																																																												
② Female			54.3																																																												
② Male			54.6																																																												
③ Female			50.3																																																												
③ Male			49																																																												
④ Female			46.5																																																												
④ Male			45																																																												
⑤ Female			33.5																																																												
⑤ Male			34.7																																																												
Axial screw connection ¹⁾	2	1 - 2	1	④ HC-M-02-AT-...-16	1417296	1417297	2																																																								
																																																															
Axial screw connection ¹⁾	2	1 - 2	1	⑤ HC-M-02-AT-...-10	1417387	1417389	2																																																								
																																																															
Cable lug PE extension from 6 mm ² to 16 mm ²				HC-M-MHR-PE16	1636981		50																																																								
																																																															

Accessories



Module carrier frames
From page 594



Dummy modules
From page 594

Heavy-duty connectors

HEAVYCON B – contact inserts

Modular contact inserts

690 V ...1000 V, 40 A

Connection technology:
– Crimp connection CK 4,0

To determine the corresponding housing, see the system cross-reference list on page 502.

Notes:
For accessories, see from page 654
Order crimp contacts separately
Only operate connectors when there is no load/the power is switched off



Type	Technical data			
	① HC-M-02-CT...	② HC-M-03-CT...	③ HC-M-04-CT...	④ HC-M-03/04-CT...
Approvals	CE ENEC VDE	CE ENEC VDE	CE ENEC VDE	CE ENEC VDE
IEC data				
Rated current, contacts (at 40°C)	[A] 40	40	40	40
Overvoltage category	III	III	III	III
Degree of pollution	3	3	3	3
Rated voltage (III/3) contacts	[V] 1000	690	830	830
Rated surge voltage, contacts	[kV] 8	6	8	8
Connection cross section	[mm²] 1.5 ... 10	1.5 ... 10	1.5 ... 6	1.5 ... 6
UL data				
Rated voltage	[V] 600	600	600	600
Rated current	[A] 42	42	37	40
Connection cross section	AWG 10	10	10	10
CSA / cUL data				
Rated voltage	[V] 600	600	830	600
Rated current	[A] 34	33	30	33
Connection cross section	AWG 10	10	10	10
Material data				
Contact carrier material	PC	PC	PC	PC
Inflammability class in acc. with UL 94	V0	V0	V0	V0
Contact material	Copper alloy	Copper alloy	Copper alloy	Copper alloy
Contact surface material	Ag	Ag	Ag	Ag
Temperature data				
Ambient temperature range	[°C] -40 ... 125	-40 ... 125	-40 ... 125	-40 ... 125
General data				
Connection method	Crimp connection	Crimp connection	Crimp connection	Crimp connection
Stripping length	[mm] 9	9	9	9
Number of positions	2	3	4	7
Contact numbering	1 - 2	1 - 3	1 - 4	1 - 3
Insertion/withdrawal cycles	≥ 500	≥ 500	≥ 500	≥ 500

Derating curves

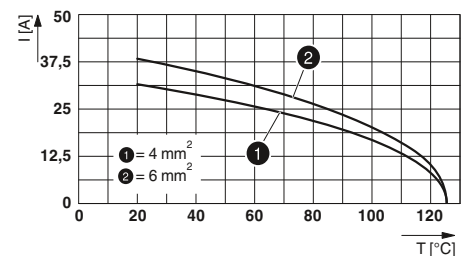
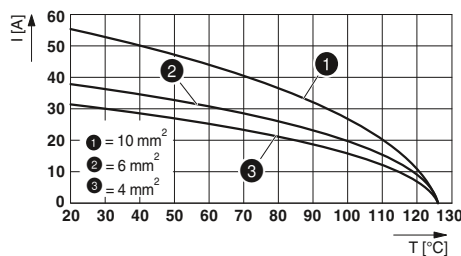
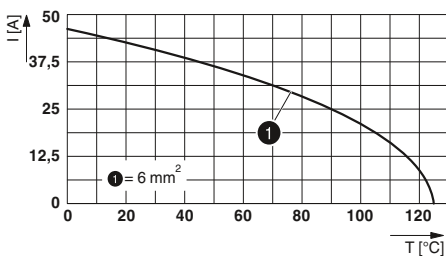

Heavy-duty connectors

HEAVYCON B – contact inserts

Modular contact inserts

230 V ... 400 V, 10 A ... 16 A

Connection technology:





- Push-in connection
- Push-in double connection

To determine the corresponding housing, see the system cross-reference list on page 502.

Notes:
For accessories, see from page 654
Only operate connectors when there is no load/the power is switched off
For assembly instructions, see phoenixcontact.net/products
¹⁾ For flexible wires with wire end protection

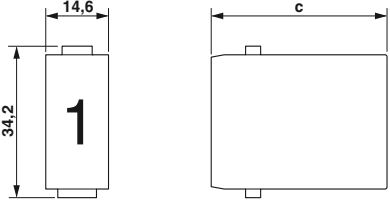
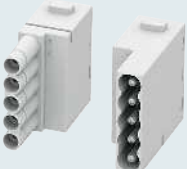
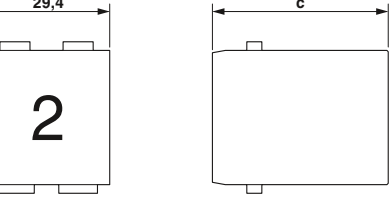

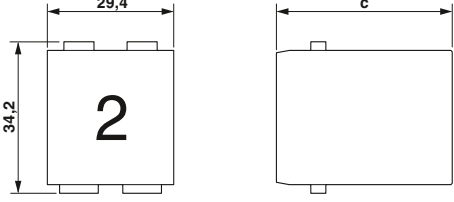
Type	Technical data				
	① HC-M-05-PT...	② HC-M-05L-TPT...	③ HC-M-06-PT...	④ HC-M-08-PT...	⑤ HC-M-12-PT...
Approvals			-	-	-
IEC data					
Rated current, contacts (at 40°C)	[A] 16	10	16	16	10
Overvoltage category	III	III	III	III	III
Degree of pollution	3	3	3	3	3
Rated voltage (III/3) contacts	[V] 400	230 / 400	500	400	250
Rated surge voltage, contacts	[kV] 6	4	6	6	4
Connection cross section	[mm ²] 0.14 ... 2.5 ¹⁾	0.25 ... 1.5 ¹⁾	0.5 ... 2.5	0.5 ... 2.5	0.14 ... 1.5 ¹⁾
UL data					
Rated voltage	[V] 600	600	-	-	-
Rated current	[A] 19	16	-	-	-
Connection cross section	AWG 14	16	-	-	-
CSA / cUL data					
Rated voltage	[V] 600	600	-	-	-
Rated current	[A] 15	12	-	-	-
Connection cross section	AWG 14	16	-	-	-
Material data					
Contact carrier material	PC	PC	PC	PC	PC
Inflammability class in acc. with UL 94	V0	V0	V0	V0	V0
Contact material	Copper alloy	Copper alloy	Copper alloy	Copper alloy	Copper alloy
Contact surface material	Ag	Ag	Au/Sn	Au/Sn	Ag
Ambient conditions					
Ambient temperature range	[°C] -40 ... 125	-40 ... 125	-40 ... 125	-40 ... 125	-40 ... 125
General data					
Connection method	Push-in connection	Push-in connection	Push-in connection	Push-in connection	Push-in connection
Hexagonal socket	[mm] -	-	-	-	-
Stripping length	[mm] 8	8	10	10	8
Number of positions	5	5	6	8	12
Contact numbering	1 - 5	1 - 5	1 - 6	1 - 8	1 - 12
Insertion/withdrawal cycles	≥ 500	≥ 500	≥ 500	≥ 500	≥ 500

Description	Pos.	Number	Slots	Type	Ordering data		Pcs./Pkt.	Dimensions (in mm)																																																										
					Female	Male		a	b	c	d																																																							
Push-in connection 	5	1 - 5	1	① HC-M-05-PT...	1417373	1417372	5	 <p>1 module slot</p>																																																										
Push-in double connection 	5	1 - 5	1	② HC-M-05L-TPT...	1423962	1423961	1	 <p>1 module slot</p>																																																										
Push-in connection 	6	1 - 6	1	③ HC-M-06-PT...	1424224	1424225	1	 <p>2 module slots</p>																																																										
Push-in connection 	8	1 - 8	1	④ HC-M-08-PT...	1424226	1424227	1	<table border="1"> <thead> <tr> <th></th> <th>a</th> <th>b</th> <th>c</th> <th>d</th> </tr> </thead> <tbody> <tr> <td>① Female</td> <td></td> <td></td> <td>34</td> <td></td> </tr> <tr> <td>① Male</td> <td></td> <td></td> <td>35.5</td> <td></td> </tr> <tr> <td>② Female</td> <td></td> <td></td> <td>38</td> <td></td> </tr> <tr> <td>② Male</td> <td></td> <td></td> <td>36</td> <td></td> </tr> <tr> <td>③ Female</td> <td></td> <td></td> <td>39</td> <td></td> </tr> <tr> <td>③ Male</td> <td></td> <td></td> <td>39</td> <td></td> </tr> <tr> <td>④ Female</td> <td></td> <td></td> <td>39</td> <td></td> </tr> <tr> <td>④ Male</td> <td></td> <td></td> <td>39</td> <td></td> </tr> <tr> <td>⑤ Female</td> <td></td> <td></td> <td>36.3</td> <td></td> </tr> <tr> <td>⑤ Male</td> <td></td> <td></td> <td>36.3</td> <td></td> </tr> </tbody> </table>					a	b	c	d	① Female			34		① Male			35.5		② Female			38		② Male			36		③ Female			39		③ Male			39		④ Female			39		④ Male			39		⑤ Female			36.3		⑤ Male			36.3	
	a	b	c	d																																																														
① Female			34																																																															
① Male			35.5																																																															
② Female			38																																																															
② Male			36																																																															
③ Female			39																																																															
③ Male			39																																																															
④ Female			39																																																															
④ Male			39																																																															
⑤ Female			36.3																																																															
⑤ Male			36.3																																																															
Push-in connection 	12	1 - 12	1	⑤ HC-M-12-PT...	1424228	1424246	1																																																											

Accessories



Module carrier frames
From page 594



Dummy modules
From page 594

Heavy-duty connectors

HEAVYCON B – contact inserts

Modular contact inserts

400 V ... 830 V, 16 A

Connection technology:







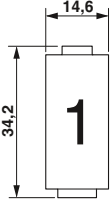
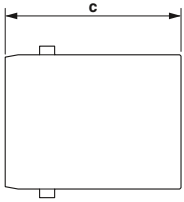

– Crimp connection CK 2,5

To determine the corresponding housing, see the system cross-reference list on page 502.

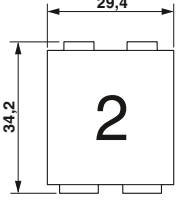
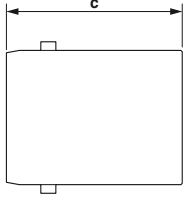
Notes:
For accessories, see from page 654
Order crimp contacts separately
Only operate connectors when there is no load/the power is switched off
1) For a housing height of ≥ 72 mm only

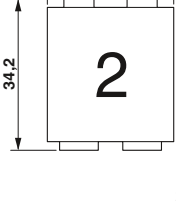
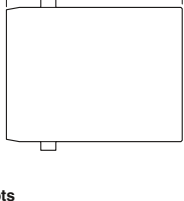

Type	Technical data				
	① HC-M-02-CT...-HV-16	② HC-M-06P-CT...	③ HC-M-06-CT...	④ HC-M-08-CT...	⑤ HC-M-20-CT...
Approvals					
IEC data					
Rated current, contacts (at 40°C)	[A] 16	16	16	16	16
Overvoltage category	III	III	III	III	III
Degree of pollution	3	3	3	3	3
Rated voltage (III/3) contacts	[V] 2900 / 5000	830	500	400	690
Rated surge voltage, contacts	[kV] 15	8	6	6	6
Connection cross section	[mm ²] 0.5 ... 4	0.5 ... 4	0.5 ... 4	0.5 ... 4	0.5 ... 4
UL data					
Rated voltage	[V] 600	600	600	600	600
Rated current	[A] 28	24	24	20	17.5
Connection cross section	AWG 12	12	12	12	12
CSA / cUL data					
Rated voltage	[V] 600	600	600	600	600
Rated current	[A] 24	18	18	16	14
Connection cross section	AWG 12	12	12	12	12
Material data					
Contact carrier material	PC / PTFE	PC	PC	PC	PC
Inflammability class in acc. with UL 94	V0	V0	V0	V0	V0
Contact material	Copper alloy	Copper alloy	Copper alloy	Copper alloy	Copper alloy
Contact surface material	Ag (alternatively Au)	Ag (alternatively Au)	Ag (alternatively Au)	Ag (alternatively Au)	Ag (alternatively Au)
Ambient conditions					
Ambient temperature range	[°C] -40 ... 125	-40 ... 125	-40 ... 125	-40 ... 125	-40 ... 125
General data					
Connection method	Crimp connection	Crimp connection	Crimp connection	Crimp connection	Crimp connection
Stripping length	[mm] 9.5	7.5	7.5	7.5	7.5
Number of positions	2	6	6	8	20
Contact numbering	I, II	1 - 6	1 - 6	1 - 8	1 - 20
Insertion/withdrawal cycles	≥ 500	≥ 500	≥ 500	≥ 500	≥ 500

Description	Pos.	Number	Slots	Ordering data			Pcs./ Pkt.	Dimensions (in mm)																																																								
				Type	Female	Male																																																										
Crimp connection CK 2,5¹⁾ 	2	I, II	2	① HC-M-02-CT...-HV-16	1417407	1417408	1	 	1 module slot																																																							
Crimp connection CK 2,5 	6	1 - 6	1	② HC-M-06P-CT...	1414369	1414368	5	 	2 module slots																																																							
Crimp connection CK 2,5 	6	1 - 6	1	③ HC-M-06-CT...	1414367	1414366	5	 	2 module slots																																																							
Crimp connection CK 2,5 	8	1 - 8	1	④ HC-M-08-CT...	1414371	1414370	5	<table border="1"> <thead> <tr> <th></th> <th>a</th> <th>b</th> <th>c</th> <th>d</th> </tr> </thead> <tbody> <tr> <td>① Female</td> <td></td> <td></td> <td>64.3</td> <td></td> </tr> <tr> <td>① Male</td> <td></td> <td></td> <td>61.3</td> <td></td> </tr> <tr> <td>② Female</td> <td></td> <td></td> <td>37.4</td> <td></td> </tr> <tr> <td>② Male</td> <td></td> <td></td> <td>38.9</td> <td></td> </tr> <tr> <td>③ Female</td> <td></td> <td></td> <td>35.8</td> <td></td> </tr> <tr> <td>③ Male</td> <td></td> <td></td> <td>34</td> <td></td> </tr> <tr> <td>④ Female</td> <td></td> <td></td> <td>35.8</td> <td></td> </tr> <tr> <td>④ Male</td> <td></td> <td></td> <td>34.5</td> <td></td> </tr> <tr> <td>⑤ Female</td> <td></td> <td></td> <td>39.95</td> <td></td> </tr> <tr> <td>⑤ Male</td> <td></td> <td></td> <td>37.6</td> <td></td> </tr> </tbody> </table>		a	b	c	d	① Female			64.3		① Male			61.3		② Female			37.4		② Male			38.9		③ Female			35.8		③ Male			34		④ Female			35.8		④ Male			34.5		⑤ Female			39.95		⑤ Male			37.6		
	a	b	c	d																																																												
① Female			64.3																																																													
① Male			61.3																																																													
② Female			37.4																																																													
② Male			38.9																																																													
③ Female			35.8																																																													
③ Male			34																																																													
④ Female			35.8																																																													
④ Male			34.5																																																													
⑤ Female			39.95																																																													
⑤ Male			37.6																																																													
Crimp connection CK 2,5 	20	1 - 20	2	⑤ HC-M-20-CT...	1414373	1414372	2																																																									
Turned crimp contacts CK 2,5 Silver-plated 								<table border="1"> <thead> <tr> <th>Cross section mm² / AWG</th> <th>Female</th> <th>Male</th> <th>Pcs.</th> </tr> </thead> <tbody> <tr> <td>0.5 - 0.5 / 20</td> <td>CK2,5-ED-0,50... AG</td> <td>1663640</td> <td>1663572</td> <td>100</td> </tr> <tr> <td>0.75 - 0.75 / 18</td> <td>CK2,5-ED-0,75... AG</td> <td>1663653</td> <td>1663585</td> <td>100</td> </tr> <tr> <td>0.75 - 1 / 18</td> <td>CK2,5-ED-1,00... AG</td> <td>1663666</td> <td>1663598</td> <td>100</td> </tr> <tr> <td>1.5 - 1.5 / 16</td> <td>CK2,5-ED-1,50... AG</td> <td>1663679</td> <td>1663608</td> <td>100</td> </tr> <tr> <td>2.5 - 2.5 / 14</td> <td>CK2,5-ED-2,50... AG</td> <td>1663682</td> <td>1663611</td> <td>100</td> </tr> <tr> <td>4 - 4 / 12</td> <td>CK2,5-ED-4,00... AG</td> <td>1663705</td> <td>1663637</td> <td>100</td> </tr> </tbody> </table>	Cross section mm ² / AWG	Female	Male	Pcs.	0.5 - 0.5 / 20	CK2,5-ED-0,50... AG	1663640	1663572	100	0.75 - 0.75 / 18	CK2,5-ED-0,75... AG	1663653	1663585	100	0.75 - 1 / 18	CK2,5-ED-1,00... AG	1663666	1663598	100	1.5 - 1.5 / 16	CK2,5-ED-1,50... AG	1663679	1663608	100	2.5 - 2.5 / 14	CK2,5-ED-2,50... AG	1663682	1663611	100	4 - 4 / 12	CK2,5-ED-4,00... AG	1663705	1663637	100																						
Cross section mm ² / AWG	Female	Male	Pcs.																																																													
0.5 - 0.5 / 20	CK2,5-ED-0,50... AG	1663640	1663572	100																																																												
0.75 - 0.75 / 18	CK2,5-ED-0,75... AG	1663653	1663585	100																																																												
0.75 - 1 / 18	CK2,5-ED-1,00... AG	1663666	1663598	100																																																												
1.5 - 1.5 / 16	CK2,5-ED-1,50... AG	1663679	1663608	100																																																												
2.5 - 2.5 / 14	CK2,5-ED-2,50... AG	1663682	1663611	100																																																												
4 - 4 / 12	CK2,5-ED-4,00... AG	1663705	1663637	100																																																												

Accessories



Module carrier frames
From page 594



Crimping tools
From page 670



Crimp contacts, gold-plated
From page 666



Dummy modules
From page 594

Heavy-duty connectors

HEAVYCON B – contact inserts

Modular contact inserts

160 V ... 250 V, 10 A

Connection technology:

– Crimp connection CK 1,6

To determine the corresponding housing, see the system cross-reference list on page 502.

Notes:
For accessories, see from page 654
Order crimp contacts separately
Only operate connectors when there is no load/the power is switched off



Type	Technical data			
	① HC-M-12-CT...	② HC-M-17-CT...		
Approvals	CE ENEC VDE	CE ENEC VDE		
IEC data				
Rated current, contacts (at 40°C)	[A] 10	10		
Overtoltage category	III	III		
Degree of pollution	3	3		
Rated voltage (III/3) contacts	[V] 250	160		
Rated surge voltage, contacts	[kV] 4	2.5		
Connection cross section	[mm²] 0.14 ... 2.5	0.14 ... 2.5		
UL data				
Rated voltage	[V] 250	160		
Rated current	[A] 16	14		
Connection cross section	AWG 14	14		
CSA / cUL data				
Rated voltage	[V] 250	160		
Rated current	[A] 12	10		
Connection cross section	AWG 14	14		
Material data				
Contact carrier material	PC	PC		
Inflammability class in acc. with UL 94	V0	V0		
Contact material	Copper alloy	Copper alloy		
Contact surface material	Ag (alternatively Au)	Ag (alternatively Au)		
Temperature data				
Ambient temperature range	[°C] -40 ... 125	-40 ... 125		
General data				
Connection method	Crimp connection	Crimp connection		
Stripping length	[mm] 8	8		
Number of positions	12	17		
Contact numbering	1 - 12	1 - 17		
Insertion/withdrawal cycles	≥ 500	≥ 500		

Heavy-duty connectors

HEAVYCON B – contact inserts

Modular contact inserts

50 V, 5 A ... 10 A

Connection technology:

- Crimp connection VS 1,0
- Crimp connection CK 1,6







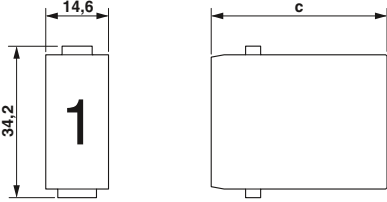

To determine the corresponding housing, see the system cross-reference list on page 502.

Notes:
For accessories, see from page 654
Order crimp contacts separately
Only operate connectors when there is no load/the power is switched off
¹⁾ For a housing height of ≥ 72 mm only

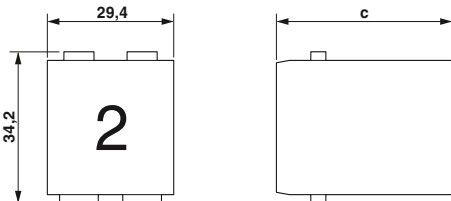
new

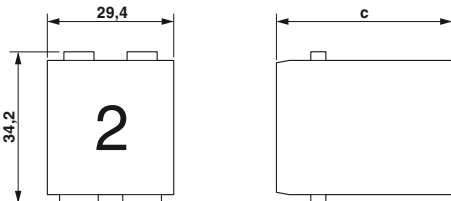

Type	Technical data		
	① HC-M-02-EMC-...	② HC-M-08-EMC-DSUB-...	③ HC-M-EMV-.../3-9,5
Approvals	ERL SA	-	SA US ERL
IEC data			
Rated current, contacts (at 40°C)	[A] 10	5	10
Overtoltage category	III	III	III
Degree of pollution	3	3	3
Rated voltage (III/3) contacts	[V] 50	50	50
Rated surge voltage, contacts	[kV] 0.8	0.8	0.8
Connection cross section	[mm ²] 0.14 ... 2.5	0.09 ... 0.52	0.14 ... 2.5
UL data			
Rated voltage	[V] -	-	42
Rated current	[A] -	-	10
Connection cross section	AWG -	-	16
CSA / cUL data			
Rated voltage	[V] -	-	42
Rated current	[A] -	-	9
Connection cross section	AWG -	-	16
Material data			
Contact carrier material	PC	PC	PC
Inflammability class in acc. with UL 94	V0	V0	V0
Contact material	Copper alloy	Copper alloy	Copper alloy
Contact surface material	Ag (power)/Au (signal)	AU	Ag (alternatively Au)
Temperature data			
Ambient temperature range	[°C] -40 ... 125	-40 ... 85	-40 ... 85
General data			
Connection method	Crimp connection	-	Crimp connection
Stripping length	[mm] -	-	8
Number of positions	2	8	4
Contact numbering	1 - 2	1 - 8	1 - 4
Insertion/withdrawal cycles	≥ 500	≥ 500	≥ 500

Description	Pos.	Number	Slots	Ordering data			Pcs./ Pkt.	Dimensions (in mm)																																			
				Type	Female	Male																																					
EMC module¹⁾ 	2	1 - 2	2	① HC-M-02-EMC-...	1417376	1417374	2																																				
EMC connector, crimp connection VS 1,0 	8	1 - 8		② HC-M-08-EMC-DSUB-...	1066080	1066082	1																																				
EMC connector, crimp connection CK 1,6 	4	1 - 4		③ HC-M-EMV-.../3-9,5	1636091	1636088	1																																				
Shield adapters 				HC-M-ADP-EMC	1420486	1420486	1	<table border="1"> <thead> <tr> <th></th> <th>a</th> <th>b</th> <th>c</th> <th>d</th> </tr> </thead> <tbody> <tr> <td>① Female</td> <td></td> <td></td> <td>34</td> <td></td> </tr> <tr> <td>① Male</td> <td></td> <td></td> <td></td> <td>34</td> </tr> <tr> <td>② Female</td> <td></td> <td></td> <td>15.5</td> <td>15.5</td> </tr> <tr> <td>② Male</td> <td></td> <td></td> <td></td> <td>15.5</td> </tr> <tr> <td>③ Female</td> <td></td> <td></td> <td>15.5</td> <td></td> </tr> <tr> <td>③ Male</td> <td></td> <td></td> <td></td> <td>15.5</td> </tr> </tbody> </table>		a	b	c	d	① Female			34		① Male				34	② Female			15.5	15.5	② Male				15.5	③ Female			15.5		③ Male				15.5
	a	b	c	d																																							
① Female			34																																								
① Male				34																																							
② Female			15.5	15.5																																							
② Male				15.5																																							
③ Female			15.5																																								
③ Male				15.5																																							
Turned crimp contacts VS 1,0 Gold-plated 			Cross section mm ² / AWG 0.08 - 0.12 / 28 - 26 0.08 - 0.34 / 28 - 22 0.2 - 0.5 / 24 - 20	CUC-DSC-...1BAU-S/DSC28 CUC-DSC-...1BAU-S/DSC22 CUC-DSC-...1BAU-S/DSC24	1418787 1418790 1418788	1418784 1418789 1418786	100 100 100																																				
Turned crimp contacts CK 1,6 Silver-plated 			Cross section mm ² / AWG 0.14 - 0.37 / 26 - 22 0.5 - 0.5 / 20 0.75 - 0.75 / 18 0.75 - 1 / 18 1.5 - 1.5 / 16 2.5 - 2.5 / 14	CK1,6-ED-0,37... AG CK1,6-ED-0,50... AG CK1,6-ED-0,75... AG CK1,6-ED-1,00... AG CK1,6-ED-1,50... AG CK1,6-ED-2,50... AG	1663394 1663404 1663417 1663420 1663433 1663446	1663336 1663349 1663352 1663365 1663378 1663381	100 100 100 100 100 100																																				

Accessories



Module carrier frames
From page 594



Crimping tools
From page 670



Dummy modules
From page 594

Heavy-duty connectors

HEAVYCON B – contact inserts

Modular contact inserts

50 V, 10 A

Connection technology:

- Crimp connection CK 1,6
- Crimp connection CK 2,5







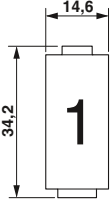
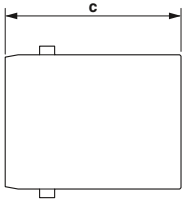

To determine the corresponding housing, see the system cross-reference list on page 502.

Notes:
For accessories, see from page 654
Order crimp contacts separately
Only operate connectors when there is no load/the power is switched off
¹⁾ For a housing height of ≥ 72 mm only

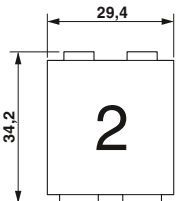
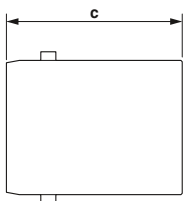
new

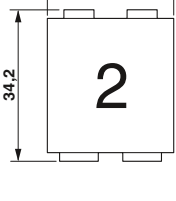
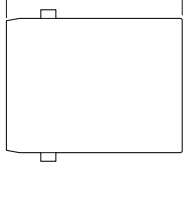

Type	Technical data		
	① HC-M-02-EMC-...	② HC-M-01-COAX-CK1,6-75-...	③ HC-M-01-COAX-CK2,5-50-...
Approvals	CE ENEC UL	UL	-
IEC data			
Rated current, contacts (at 40°C)	[A] 10	10	16
Overtoltage category	III	III	III
Degree of pollution	3	3	3
Rated voltage (III/3) contacts	[V] 50	50	50
Rated surge voltage, contacts	[kV] 0.8	0.8	0.8
Connection cross section	[mm ²] 0.14 ... 2.5	0.14 ... 2.5	0.5 ... 4
UL data			
Rated voltage	[V] -	50	-
Rated current	[A] -	10	-
Connection cross section	AWG -	-	-
CSA / cUL data			
Rated voltage	[V] -	-	-
Rated current	[A] -	-	-
Connection cross section	AWG -	-	-
Material data			
Contact carrier material	PC	PC	PC
Inflammability class in acc. with UL 94	V0	V0	V0
Contact material	Copper alloy	Copper alloy	Copper alloy
Contact surface material	Ag (power)/Au (signal)	AU	AU
Temperature data			
Ambient temperature range	[°C] -40 ... 125	-40 ... 85	-40 ... 85
General data			
Connection method	Crimp connection	-	-
Stripping length	[mm] -	8	8
Number of positions	2	1	1
Contact numbering	1 - 2	-	-
Insertion/withdrawal cycles	≥ 500	≥ 500	≥ 500

Description	Pos.	Number	Slots	Ordering data			Pcs./ Pkt.	Dimensions (in mm)																																				
				Type	Female	Male		1	2																																			
EMC module¹⁾ 	2	1 - 2	2	① HC-M-02-EMC-...	1417376	1417374	2	 	1 module slot																																			
Coaxial connectors 75 Ω, crimp connection CK 1,6 	1			② HC-M-01-COAX-CK1,6-75-...	1066961	1066962	1	 	2 module slots																																			
Coaxial connectors 50 Ω, crimp connection CK 2,5 	1			③ HC-M-01-COAX-CK2,5-50-...	1066959	1066960	1	 	2 module slots																																			
Shield adapters 				HC-M-ADP-EMC	1420486	1420486	1	<table border="1"> <thead> <tr> <th></th> <th>a</th> <th>b</th> <th>c</th> <th>d</th> </tr> </thead> <tbody> <tr> <td>① Female</td> <td></td> <td></td> <td>34</td> <td></td> </tr> <tr> <td>① Male</td> <td></td> <td></td> <td></td> <td>34</td> </tr> <tr> <td>② Female</td> <td></td> <td></td> <td>15.5</td> <td>15.5</td> </tr> <tr> <td>② Male</td> <td></td> <td></td> <td></td> <td>15.5</td> </tr> <tr> <td>③ Female</td> <td></td> <td></td> <td>15.5</td> <td>15.5</td> </tr> <tr> <td>③ Male</td> <td></td> <td></td> <td></td> <td>15.5</td> </tr> </tbody> </table>		a	b	c	d	① Female			34		① Male				34	② Female			15.5	15.5	② Male				15.5	③ Female			15.5	15.5	③ Male				15.5	
	a	b	c	d																																								
① Female			34																																									
① Male				34																																								
② Female			15.5	15.5																																								
② Male				15.5																																								
③ Female			15.5	15.5																																								
③ Male				15.5																																								
Turned crimp contacts CK 1,6 Silver-plated 			Cross section mm ² / AWG 0.14 - 0.37 / 26 - 22 0.5 - 0.5 / 20 0.75 - 0.75 / 18 0.75 - 1 / 18 1.5 - 1.5 / 16 2.5 - 2.5 / 14	CK1,6-ED-0,37... AG CK1,6-ED-0,50... AG CK1,6-ED-0,75... AG CK1,6-ED-1,00... AG CK1,6-ED-1,50... AG CK1,6-ED-2,50... AG	1663394 1663404 1663417 1663420 1663433 1663446	1663336 1663349 1663352 1663365 1663378 1663381	100 100 100 100 100 100																																					
Turned crimp contacts CK 2,5 Silver-plated 			Cross section mm ² / AWG 0.5 - 0.5 / 20 0.75 - 0.75 / 18 0.75 - 1 / 18 1.5 - 1.5 / 16 2.5 - 2.5 / 14 4 - 4 / 12	CK2,5-ED-0,50... AG CK2,5-ED-0,75... AG CK2,5-ED-1,00... AG CK2,5-ED-1,50... AG CK2,5-ED-2,50... AG CK2,5-ED-4,00... AG	1663640 1663653 1663666 1663679 1663682 1663705	1663572 1663585 1663598 1663608 1663611 1663637	100 100 100 100 100 100																																					

Accessories



Module carrier frames
From page 594



Crimping tools
From page 670



Dummy modules
From page 594

Heavy-duty connectors

HEAVYCON B – contact inserts

Modular contact inserts

50 V, 1 ... 5 A

Connection technology:

- Crimp connection VS 1,0
- Screw connection







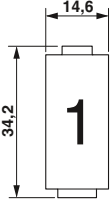
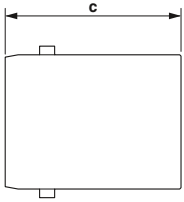

Guide pins and sockets are mandatory for the HC-M-25-CT... and HC-M-DSUB 09-... modules; see page 657.

To determine the corresponding housing, see the system cross-reference list on page 502.

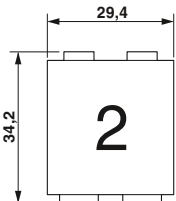
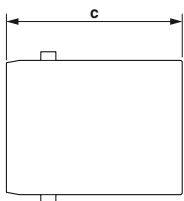
Notes:
For accessories, see from page 654
Order crimp contacts separately
Only operate connectors when there is no load/the power is switched off

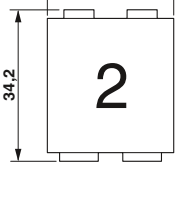
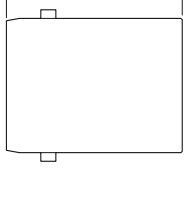

Type	Technical data				
	① HC-M-25-CT-...	② HC-M-08-GBIT-CT-...	③ HC-M-DSUB 09-UT-...	④ HC-M-DSUB 09-CT-...	⑤ HC-M-DSUB 09/2-CT-...
Approvals			ENEC	ENEC	ENEC
IEC data					
Rated current, contacts (at 40°C)	[A] 4	5	1	1	5
Overvoltage category	III	III	III	III	III
Degree of pollution	3	3	3	3	3
Rated voltage (III/3) contacts	[V] 50	50	50	50	50
Rated surge voltage, contacts	[kV] 0.8	0.8	0.8	0.8	0.8
Connection cross section	[mm²] 0.08 ... 0.5	0.08 ... 0.5	0.08 ... 0.5	0.08 ... 0.5	0.09 ... 0.82
UL data					
Rated voltage	[V] 50	50	-	-	-
Rated current	[A] 5	5	-	-	-
Connection cross section	AWG 20	22	-	-	-
CSA / cUL data					
Rated voltage	[V] 30	50	-	-	-
Rated current	[A] 4	5	-	-	-
Connection cross section	AWG 20	22	-	-	-
Material data					
Contact carrier material	PC	PC	PC	PC	PC
Inflammability class in acc. with UL 94	V0	V0	V0	V0	V0
Contact material	Copper alloy	Copper alloy	Copper alloy	Copper alloy	Copper alloy
Contact surface material	Au	Au	Ag	Au	Ag
Ambient conditions					
Ambient temperature range	[°C] -40 ... 125	-40 ... 85	-40 ... 125	-40 ... 125	-40 ... 125
General data					
Connection method	Crimp connection	Crimp connection	Screw connection	Crimp connection	Crimp connection
Stripping length	[mm] 4.2	4.2	4.2	4.2	4.2
Number of positions	25	8	9	9	9
Contact numbering	1 - 25	1 - 8	1 - 9	1 - 9	1 - 9
Insertion/withdrawal cycles	≥ 500	≥ 500	≥ 500	≥ 500	≥ 500

Description	Pos.	Number	Slots	Ordering data			Pcs./ Pkt.	Dimensions (in mm)																																																								
				Type	Female	Male																																																										
Crimp connection VS 1,0 	25	1 - 25	1	① HC-M-25-CT...	1414375	1414374	5	 	1 module slot																																																							
Ethernet connector, crimp connection VS 1,0 	8	1 - 8	1	② HC-M-08-GBIT-CT...	1417303	1417302	1	 	2 module slots																																																							
D-SUB 09 module, screw connection 	9	1 - 9	1	For 1 cable ③ HC-M-DSUB 09-UT...	1417307	1423723	1	 	2 module slots																																																							
D-SUB 09 module, crimp connection VS 1,0 	9	1 - 9	1	For 1 cable ④ HC-M-DSUB 09-CT...	1417308	1417309	1	<table border="1"> <thead> <tr> <th></th> <th>a</th> <th>b</th> <th>c</th> <th>d</th> </tr> </thead> <tbody> <tr> <td>① Female</td> <td></td> <td></td> <td>30.65</td> <td></td> </tr> <tr> <td>① Male</td> <td></td> <td></td> <td>34</td> <td></td> </tr> <tr> <td>② Female</td> <td></td> <td></td> <td>40.3</td> <td></td> </tr> <tr> <td>② Male</td> <td></td> <td></td> <td>41.4</td> <td></td> </tr> <tr> <td>③ Female</td> <td></td> <td></td> <td>35.7</td> <td></td> </tr> <tr> <td>③ Male</td> <td></td> <td></td> <td>35.7</td> <td></td> </tr> <tr> <td>④ Female</td> <td></td> <td></td> <td>35.2</td> <td></td> </tr> <tr> <td>④ Male</td> <td></td> <td></td> <td>35.2</td> <td></td> </tr> <tr> <td>⑤ Female</td> <td></td> <td></td> <td>35.7</td> <td></td> </tr> <tr> <td>⑤ Male</td> <td></td> <td></td> <td>35.7</td> <td></td> </tr> </tbody> </table>		a	b	c	d	① Female			30.65		① Male			34		② Female			40.3		② Male			41.4		③ Female			35.7		③ Male			35.7		④ Female			35.2		④ Male			35.2		⑤ Female			35.7		⑤ Male			35.7		
	a	b	c	d																																																												
① Female			30.65																																																													
① Male			34																																																													
② Female			40.3																																																													
② Male			41.4																																																													
③ Female			35.7																																																													
③ Male			35.7																																																													
④ Female			35.2																																																													
④ Male			35.2																																																													
⑤ Female			35.7																																																													
⑤ Male			35.7																																																													
D-SUB 09/2 module, crimp connection VS 1,0 	9	1 - 9	1	For 2 cables ⑤ HC-M-DSUB 09/2-CT...	1079793	1079796	1																																																									
Turned crimp contacts VS 1,0 Gold-plated 								<table border="1"> <thead> <tr> <th>Cross section mm² / AWG</th> <th>Type</th> <th>Female</th> <th>Male</th> <th>Pcs.</th> </tr> </thead> <tbody> <tr> <td>0.08 - 0.12 / 28 - 26</td> <td>CUC-DSC...1BAU-S/DSC28</td> <td>1418787</td> <td>1418784</td> <td>100</td> </tr> <tr> <td>0.08 - 0.34 / 28 - 22</td> <td>CUC-DSC...1BAU-S/DSC22</td> <td>1418790</td> <td>1418789</td> <td>100</td> </tr> <tr> <td>0.2 - 0.5 / 24 - 20</td> <td>CUC-DSC...1BAU-S/DSC24</td> <td>1418788</td> <td>1418786</td> <td>100</td> </tr> </tbody> </table>	Cross section mm ² / AWG	Type	Female	Male	Pcs.	0.08 - 0.12 / 28 - 26	CUC-DSC...1BAU-S/DSC28	1418787	1418784	100	0.08 - 0.34 / 28 - 22	CUC-DSC...1BAU-S/DSC22	1418790	1418789	100	0.2 - 0.5 / 24 - 20	CUC-DSC...1BAU-S/DSC24	1418788	1418786	100																																				
Cross section mm ² / AWG	Type	Female	Male	Pcs.																																																												
0.08 - 0.12 / 28 - 26	CUC-DSC...1BAU-S/DSC28	1418787	1418784	100																																																												
0.08 - 0.34 / 28 - 22	CUC-DSC...1BAU-S/DSC22	1418790	1418789	100																																																												
0.2 - 0.5 / 24 - 20	CUC-DSC...1BAU-S/DSC24	1418788	1418786	100																																																												

Accessories



Module carrier frames
From page 594



Crimping tools
From page 670



Guide elements
From page 657



Dummy modules
From page 594

Heavy-duty connectors

HEAVYCON B – contact inserts

Modular contact inserts, coaxial modules

50 V, 1.5 A

Connection technology:

– Coaxial contacts





Guide pins and guide sockets are mandatory for the HC-M-04-KT... series modules, see page 657.

To determine the corresponding housing, see the system cross-reference list on page 502.

Notes:
For accessories, see from page 654
Only operate connectors when there is no load/the power is switched off
50 Ω coaxial contacts for cables RG 174/U, RG 188 A/U, RG 316/U
75 Ω coaxial contacts for cables RG 179 B/U, RG 187 A/U

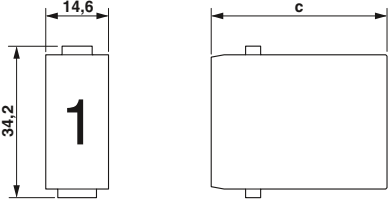

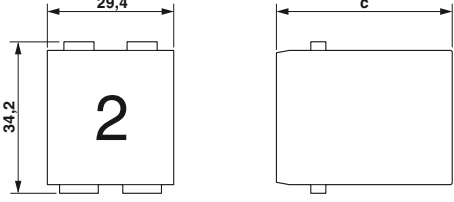
		Technical data			
Type		① HC-M-04-KT...			
Approvals					
IEC data					
Rated current, contacts (at 40°C)	[A]	1.5			
Overvoltage category		III			
Degree of pollution		3			
Rated voltage (III/3) contacts	[V]	50			
Rated surge voltage, contacts	[kV]	0.8			
Connection cross section	[mm ²]	0.14 ... 2.5			
UL data					
Rated voltage	[V]	-			
Rated current	[A]	-			
Connection cross section	AWG	-			
CSA / cUL data					
Rated voltage	[V]	-			
Rated current	[A]	-			
Connection cross section	AWG	-			
Material data					
Contact carrier material		PC			
Inflammability class in acc. with UL 94		V0			
Contact material		Copper alloy			
Contact surface material		AU			
Temperature data					
Ambient temperature range	[°C]	-40 ... 125			
General data					
Connection method		Soldering and crimp connection			
Stripping length	[mm]	2.5			
Number of positions		4			
Contact numbering		1 - 4			
Insulation resistance	[GΩ]	≥ 10			
Contact resistance	[mΩ]	-			
Insertion/withdrawal cycles		≥ 500			

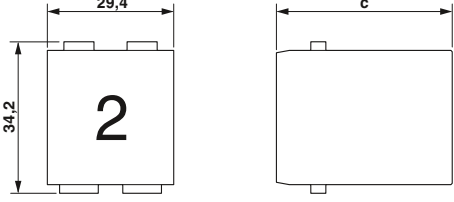
Description	Pos.	Number	Slots	Ordering data			Pcs./Pkt.	Dimensions (in mm)															
				Type	Order No. Female	Order No. Male																	
Coaxial module 	4	1 - 4	1	① HC-M-04-KT...	1417370	1417371	5																
Coaxial contacts 50 Ω For cables RG 174/U, RG 188 A/U, RG 316/U 				HC-M-04-...-KOAX-50	1676815	1676802	10	1 module slot 															
Coaxial contacts 75 Ω For cables RG 179 B/U, RG 187 A/U 				HC-M-04-...-KOAX-75	1686245	1686258	10	2 module slots 															
								<table border="1"> <thead> <tr> <th></th> <th>a</th> <th>b</th> <th>c</th> <th>d</th> </tr> </thead> <tbody> <tr> <td>① Female</td> <td></td> <td></td> <td>32.6</td> <td></td> </tr> <tr> <td>① Male</td> <td></td> <td></td> <td>31.5</td> <td></td> </tr> </tbody> </table>		a	b	c	d	① Female			32.6		① Male			31.5	
	a	b	c	d																			
① Female			32.6																				
① Male			31.5																				

Accessories



Module carrier frames
From page 594



Crimping tools
From page 671



Guide elements
From page 657



Dummy modules
From page 594

Heavy-duty connectors

HEAVYCON B – contact inserts

Modular contact inserts, RJ45 modules







Connection technology:
– RJ45 and RJ1

To determine the corresponding
housing, see the system cross-reference
list on page 502.

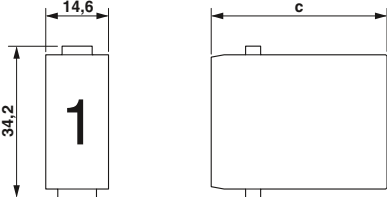
Notes:
For accessories, see from page 654
Only operate connectors when there is no load/the power is switched off



Type	Technical data			
	① HC-M-RJ45-08-GC-... RJ45, CAT6 _A , 10 Gbps EAC UL	② HC-M-RJ45-08-... RJ45, CAT6 _A , 10 Gbps EAC UL	③ HC-M-RJ45-AD-PC-... for RJ45 patch cable EAC UL	④ HC-M-RJI-AD-PC-... for RJ industrial inserts EAC UL
Approvals				
IEC data				
Rated current, contacts (at 40°C)	[A] 1	1	1	1
Overtoltage category	III	III	III	III
Degree of pollution	3	3	3	3
Rated voltage (III/3) contacts	[V] 50	50	50	50
Rated surge voltage, contacts	[kV] 0.8	0.8	0.8	0.8
Connection cross section	[mm ²] -	-	-	-
UL data				
Rated voltage	[V] -	-	-	-
Rated current	[A] -	-	-	-
Connection cross section	AWG -	-	-	-
CSA / cUL data				
Rated voltage	[V] -	-	-	-
Rated current	[A] -	-	-	-
Connection cross section	AWG -	-	-	-
Material data				
Contact carrier material	PC	PC	PC	PC
Inflammability class in acc. with UL 94	V0	V0	V0	V0
Contact material	Copper alloy	Phosphor bronze	Copper alloy	Copper alloy
Contact surface material	Au	Au	Au	Au
Temperature data				
Ambient temperature range	[°C] -40 ... 70	-25 ... 60	-25 ... 60	-40 ... 70
General data				
Connection method	-	-	-	-
Stripping length	[mm] -	-	-	-
Number of positions	8	8	8	8
Contact numbering	1 - 8	1 - 8	1 - 8	1 - 8
Insulation resistance	[GΩ] -	-	-	-
Contact resistance	[mΩ] -	-	-	-
Insertion/withdrawal cycles	≥ 500	≥ 500	≥ 500	≥ 500

Description	Pos.	Number	Slots	Ordering data			Pcs./Pkt.	Dimensions (in mm)																																													
				Type	Female	Male																																															
RJ45 gender changer 	8	1 - 8	1	RJ45, CAT6 _A , 10 Gbps ① HC-M-RJ45-08-GC-...	1419886		1	 1 module slot																																													
RJ45 male insert 	8	1 - 8	1	RJ45, CAT6 _A , 10 Gbps ② HC-M-RJ45-08-...		1419887	1																																														
RJ45 adapter 	8	1 - 8	1	for RJ45 patch cable ③ HC-M-RJ45-AD-PC-...		1419885	1																																														
RJ45 adapter 	8	1 - 8	1	for RJ industrial inserts ④ HC-M-RJI-AD-PC-...		1419888	1																																														
RJ45 patch cable Length: 1 m 				CAT6 _A CAT6 CAT5e	NBC-R4AC1/1,0-94G/R4AC1-BU FL CAT6 PATCH 1,0 FL CAT5 PATCH 1,0		1 10 10	<table border="1"> <thead> <tr> <th></th> <th>a</th> <th>b</th> <th>c</th> <th>d</th> </tr> </thead> <tbody> <tr> <td>① Female</td> <td></td> <td></td> <td>36.7</td> <td></td> </tr> <tr> <td>① Male</td> <td></td> <td></td> <td></td> <td></td> </tr> <tr> <td>② Female</td> <td></td> <td></td> <td></td> <td></td> </tr> <tr> <td>② Male</td> <td></td> <td></td> <td>41</td> <td></td> </tr> <tr> <td>③ Female</td> <td></td> <td></td> <td></td> <td></td> </tr> <tr> <td>③ Male</td> <td></td> <td></td> <td>50.7</td> <td></td> </tr> <tr> <td>④ Female</td> <td></td> <td></td> <td></td> <td></td> </tr> <tr> <td>④ Male</td> <td></td> <td></td> <td>54.5</td> <td></td> </tr> </tbody> </table>		a	b	c	d	① Female			36.7		① Male					② Female					② Male			41		③ Female					③ Male			50.7		④ Female					④ Male			54.5	
	a	b	c	d																																																	
① Female			36.7																																																		
① Male																																																					
② Female																																																					
② Male			41																																																		
③ Female																																																					
③ Male			50.7																																																		
④ Female																																																					
④ Male			54.5																																																		
RJ45 connector, IP20, CAT5e 				Cross section mm ² / AWG 0.14 - 0.25 / 26 - 24 0.23 - 0.32 / 23 - 22	CUC-INI-C1ZNI-S/R4IE8 CUC-INI-C1ZNI-S/R4IP8		1 1																																														

Accessories



Module carrier frames
From page 594



RJ45 patch cables
From page 721



Dummy modules
From page 594

Heavy-duty connectors

HEAVYCON B – contact inserts

Modular contact inserts, pneumatic modules

Connection technology:

- Pneumatic contact with valve
- Pneumatic contact without valve







Guide pins and guide sockets are mandatory for the HC-M-02-PN-M-... and HC-M-03-PN-M-... modules; see page 657.

To determine the corresponding housing, see the system cross-reference list on page 502.

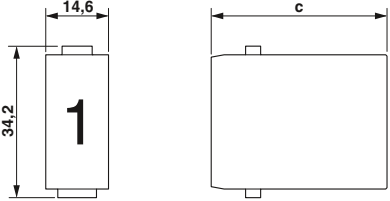
Notes:
For accessories, see from page 654

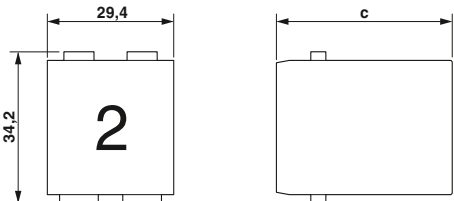

Type	Technical data					
	① HC-M-02-PN-M-...	② HC-M-PN2-6,00-...-V With valve	③ HC-M-PN2-6,00-... Without valve	④ HC-M-03-PN-M-...	⑤ ⑥ ⑦ HC-M-PN3-1,60-BU-V With valve	⑧ ⑨ ⑩ HC-M-PN3-1,60-... Without valve
Approvals	CE ENEC 94	ERC	ERC	CE ENEC 94	ERC	ERC
Material data for pneumatic module						
Contact carrier material	PC	-	-	PC	-	-
Inflammability class in acc. with UL 94	V0	-	-	V0	-	-
Module slots	1	-	-	1	-	-
Material data for pneumatic contact						
Contact material	-	Delrin acetal	Delrin acetal	-	Delrin acetal	Delrin acetal
Seal material (contact)	-	Buna-N	Buna-N	-	Buna-N	Buna-N
Valve material (contact)	-	Polypropylene	Polypropylene	-	Polypropylene	Polypropylene
Mechanical data						
Number of positions	2	-	-	3	-	-
Contact numbering	1 - 2	-	-	1 - 3	-	-
Insertion/withdrawal cycles	≥ 500	≥ 500	≥ 500	≥ 500	≥ 500	≥ 500
Internal diameter of pressure hose connection	6 mm	6 mm	6 mm	1.6 mm	1.6 mm	1.6 mm
Operating pressure	-	8.00 bar	8.00 bar	-	8.00 bar	8.00 bar
Ambient conditions						
Ambient temperature range	°C -40 ... 80	-40 ... 80	-40 ... 80	-40 ... 80	-40 ... 80	-40 ... 80

Description	Pos.	Number	Slots	Ordering data			Pcs./Pkt.	Dimensions (in mm)			
				Type	Female	Male					
PN2 pneumatic module 	2	1 - 2	1	① HC-M-02-PN-M...	1417434	1417434	5	 <p>1 module slot</p>			
PN2 pneumatic contact 				With valve ② HC-M-PN2-6,00-...-V	1676776		10				
PN2 pneumatic contact 				Without valve ③ HC-M-PN2-6,00-...	1676763	1676750	10	 <p>2 module slots</p>			
PN3 pneumatic module 	3	1 - 3	1	④ HC-M-03-PN-M...	1417433	1417433	5				
PN3 pneumatic contact 				With valve ⑤ HC-M-PN3-1,60-BU-V With valve ⑥ HC-M-PN3-3,00-BU-V With valve ⑦ HC-M-PN3-4,00-BU-V	1663543 1663556 1663569		10 10 10				
PN3 pneumatic contact 				Without valve ⑧ HC-M-PN3-1,60-... Without valve ⑨ HC-M-PN3-3,00-... Without valve ⑩ HC-M-PN3-4,00-...	1663514 1663527 1663530	1663488 1663491 1663501	10 10 10				

	a	b	c	d
① Female			27.2	
① Male			27.2	
④ Female			27.2	
④ Male			27.2	

Accessories



Module carrier frames
From page 594



Dummy modules
From page 594

Heavy-duty connectors

HEAVYCON B – contact inserts

Modular contact inserts, module carrier frames

General data		Technical data
Module carrier frame material		Die-cast zinc alloy
Connection cross section		4 mm ² ... 6 mm ² (for PE conductor – power side)
Connection cross section		1 mm ² ... 2.5 mm ² (for PE conductor – control side)
Connection cross section	AWG	12 ... 10 (for PE conductor – power side)
Connection cross section	AWG	18 ... 14 (for PE conductor – control side)
Insertion/withdrawal cycles		≥ 500
Ambient temperature (operation)		-40°C ... 125°C



Ordering data

Description	Size	Type	Order No.	Pcs./Pkt.	Dimensions
Module carrier frame ¹⁾ 	B6	For sleeve housing (A, B, C, etc.) HC-M-B06-MFH-H	1182087	1	
	B6	For panel mounting base (a, b, c, etc.) HC-M-B06-MFH-B	1182085	1	
Module carrier frame ¹⁾ 	B10	For sleeve housing (A, B, C, etc.) HC-M-B10-MFH-H	1182089	1	
	B10	For panel mounting base (a, b, c, etc.) HC-M-B10-MFH-B	1182088	1	
Module carrier frame ¹⁾ 	B16	For sleeve housing (A, B, C, etc.) HC-M-B16-MFH-H	1182093	1	
	B16	For panel mounting base (a, b, c, etc.) HC-M-B16-MFH-B	1182090	1	
Module carrier frame ¹⁾ 	B24	For sleeve housing (A, B, C, etc.) HC-M-B24-MFH-H	1182095	1	
	B24	For panel mounting base (a, b, c, etc.) HC-M-B24-MFH-B	1182094	1	
Dummy module 		for unused slots HC-M-00	1414353	5	

Notes:
 For assembly instructions, see phoenixcontact.net/products
 Wire end protection is necessary for conductor cross sections <2.5 mm²
¹⁾ For rigid conductors and flexible wires with wire end protection

Accessories



Coding elements
From page 657

Dummy modules
From page 594

new







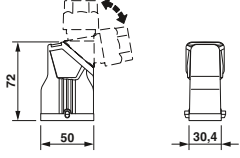

EVO M1 single-module housings, sleeve housings, panel mounting bases, contact insert modules

Technical data

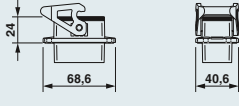
General data	
Housing material	PA
Locking latch material	PA
Sealing material	NBR, conductive
IP degree of protection	IP66
Ambient temperature (operation)	-40°C ... 125°C

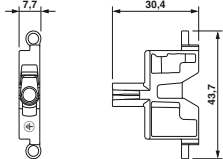

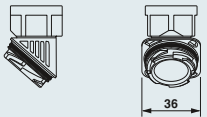
Ordering data

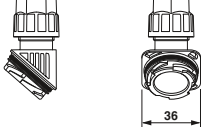
Description	Size	Type	Order No.	Pcs./Pkt.	Dimensions
EVO M1 sleeve housing 	M1	For one modular contact insert HC-EVO-M1-HHFS-PLBK	1424436	1	
EVO M1 panel mounting base 	M1	For one modular contact insert HC-EVO-M1-BWS-PLRBK	1424437	1	
PE contact insert module 		1/2 module, female HC-1/2M-UT-F-6-PE 1/2 module, male HC-1/2M-UT-M-6-PE	1424438 1424439	1 1	
Thread adapter 		HC-D-TA-M25-PLRBK HC-D-TA-PG16-PLR-BK	1411352 1411353	1 1	
Cable gland 	Clamping area 7 mm ... 13 mm 9 mm ... 17 mm	HC-D-G-M20-PLRBK HC-D-G-M25-PLRBK	1411350 1411351	1 1	

Accessories



EVO unlocking tools
From page 659



Cable glands
From page 686



Corrugated pipe adapters
see Catalog 3

Heavy-duty connectors

HEAVYCON B – housings

Size B6, plastic, ADVANCE PL sleeve housings with cable gland

General data







Housing material	PA
Lock material	Stainless steel
Sealing material	NBR
IP degree of protection (when plugged in)	IP66 / IP67
NEMA degree of protection (when plugged in)	12
Ambient temperature (operation)	-40°C ... 100°C

Technical data

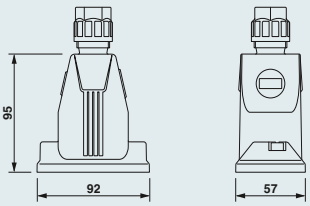
PA
Stainless steel
NBR
IP66 / IP67
12
-40°C ... 100°C

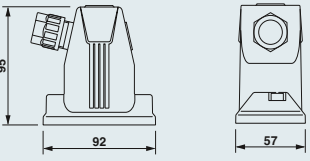

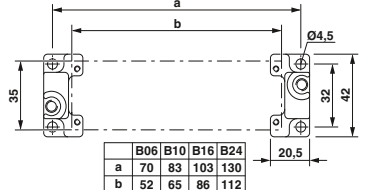
Ordering data

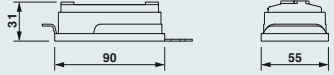
Description	Clamping area	Type	Order No.	Pcs./Pkt.	Dimensions															
Sleeve housing¹⁾ Height: 93.7 mm 	8 mm ... 13 mm 9 mm ... 17 mm	Cable outlet: top HC-ADV-B06-HHWH-1TGM20-PL HC-ADV-B06-HHWH-1TGM25-PL	1404222 1404225	1 1																
Sleeve housing¹⁾ Height: 93.7 mm 	8 mm ... 13 mm 9 mm ... 17 mm	Cable outlet: lateral HC-ADV-B06-HHWH-1SGM20-PL HC-ADV-B06-HHWH-1SGM25-PL	1404224 1404226	1 1																
Panel mounting flange 		2 pcs. per housing HC-B-AF Set with 2 panel mounting flanges HC-B-AF-SET	1686533 1604638	20 1	 <table border="1" data-bbox="1204 1533 1356 1585"> <thead> <tr> <th></th> <th>B06</th> <th>B10</th> <th>B16</th> <th>B24</th> </tr> </thead> <tbody> <tr> <td>a</td> <td>70</td> <td>83</td> <td>103</td> <td>130</td> </tr> <tr> <td>b</td> <td>52</td> <td>65</td> <td>86</td> <td>112</td> </tr> </tbody> </table>		B06	B10	B16	B24	a	70	83	103	130	b	52	65	86	112
	B06	B10	B16	B24																
a	70	83	103	130																
b	52	65	86	112																
Protective cover Height: 31.2 mm 		for sleeve side, IP50 HC-B 6-TMS-SD-IP50 for panel mounting side, IP66 HC-B 6-TMS-SD-IP66	1690736 1411494	10 10																

Notes:

Marking label: US-EMP (20X9) Order No. [0829439](#)

¹⁾ Screw locking with M6 Allen screws

Accessories



Allen keys
see Catalog 3



Replacement seals
phoenixcontact.net/products



Corrugated pipe adapters
see Catalog 3

Size B6, metal, ADVANCE sleeve housings











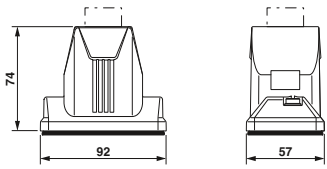

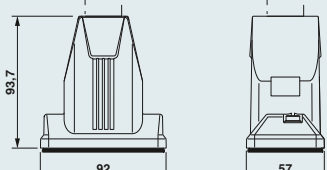
General data	
Housing material	Die-cast aluminum, salt water resistant
Surface material	uncoated / powder coated, black
Lock material	Stainless steel
Sealing material	NBR, conductive / Viton
IP degree of protection (when plugged in)	IP66 / IP68 / IP69K
NEMA degree of protection (when plugged in)	4 / 4X / 12
Ambient temperature (operation)	-40°C ... 125°C

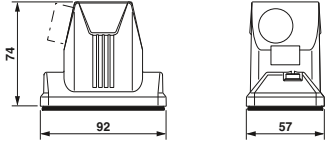
Technical data

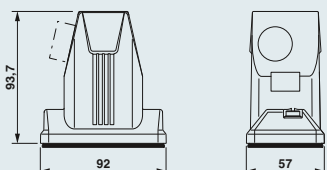
Housing material	Die-cast aluminum, salt water resistant
Surface material	uncoated / powder coated, black
Lock material	Stainless steel
Sealing material	NBR, conductive / Viton
IP degree of protection (when plugged in)	IP66 / IP68 / IP69K
NEMA degree of protection (when plugged in)	4 / 4X / 12
Ambient temperature (operation)	-40°C ... 125°C

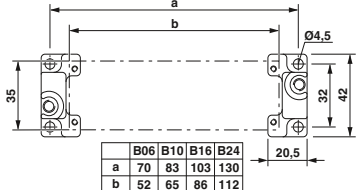
Ordering data

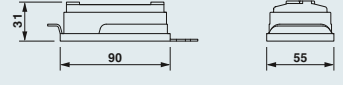
Description	Thread	Type	Order No.	Pcs./Pkt.	Dimensions															
Sleeve housing, cable outlet: top¹⁾ Height: 74 mm 	1x M20	Uncoated, EMC ready HC-ADV-B06-HLWH-1TTM20-EMC-AL	1413362	1																
	1x M25	Uncoated, EMC ready HC-ADV-B06-HLWH-1TTM25-EMC-AL	1413364	1																
		Uncoated, EMC ready, without drill hole HC-ADV-B06-HLWH-BLANK-ELC-AL	1420048	1																
	1x M20	Powder-coated, black HC-ADV-B06-HLWH-1TTM20-MF-BK	1420904	1																
	1x M25	Powder-coated, black HC-ADV-B06-HLWH-1TTM25-MF-BK	1420905	1																
Sleeve housing, cable outlet: top¹⁾ Height: 93.7 mm 	1x M25	Uncoated, EMC ready HC-ADV-B06-HHWH-1TTM25-EMC-AL	1413374	1																
	1x M32	Uncoated, EMC ready HC-ADV-B06-HHWH-1TTM32-EMC-AL	1413376	1																
		Uncoated, EMC ready, without drill hole HC-ADV-B06-HHWH-BLANK-ELC-AL	1420050	1																
	1x M25	Powder-coated, black HC-ADV-B06-HHWH-1TTM25-MF-BK	1420900	1																
	1x M32	Powder-coated, black HC-ADV-B06-HHWH-1TTM32-MF-BK	1420901	1																
Sleeve housing, cable outlet: to the side¹⁾ Height: 74 mm 	1x M20	Uncoated, EMC ready HC-ADV-B06-HLWH-1STM20-EMC-AL	1413363	1																
	1x M25	Uncoated, EMC ready HC-ADV-B06-HLWH-1STM25-EMC-AL	1413365	1																
		Uncoated, EMC ready, without drill hole HC-ADV-B06-HLWH-BLANK-ELC-AL	1420048	1																
	1x M20	Powder-coated, black HC-ADV-B06-HLWH-1STM20-MF-BK	1420902	1																
	1x M25	Powder-coated, black HC-ADV-B06-HLWH-1STM25-MF-BK	1420903	1																
Sleeve housing, cable outlet: to the side¹⁾ Height: 93.7 mm 	1x M25	Uncoated, EMC ready HC-ADV-B06-HHWH-1STM25-EMC-AL	1413375	1																
	1x M32	Uncoated, EMC ready HC-ADV-B06-HHWH-1STM32-EMC-AL	1413377	1																
		Uncoated, EMC ready, without drill hole HC-ADV-B06-HHWH-BLANK-ELC-AL	1420050	1																
	1x M25	Powder-coated, black HC-ADV-B06-HHWH-1STM25-MF-BK	1420898	1																
	1x M32	Powder-coated, black HC-ADV-B06-HHWH-1STM32-MF-BK	1420899	1																
Panel mounting flange 		2 pcs. per housing HC-B-AF Set with 2 panel mounting flanges HC-B-AF-SET	1686533 1604638	20 1	 <table border="1" data-bbox="1189 1533 1348 1585"> <tr> <td></td> <td>B06</td> <td>B10</td> <td>B16</td> <td>B24</td> </tr> <tr> <td>a</td> <td>70</td> <td>83</td> <td>103</td> <td>130</td> </tr> <tr> <td>b</td> <td>52</td> <td>65</td> <td>86</td> <td>112</td> </tr> </table>		B06	B10	B16	B24	a	70	83	103	130	b	52	65	86	112
	B06	B10	B16	B24																
a	70	83	103	130																
b	52	65	86	112																
Protective cover Height: 31.2 mm 		for sleeve side, IP50 HC-B 6-TMS-SD-IP50 for panel mounting side, IP66 HC-B 6-TMS-SD-IP66	1690736 1411494	10 10																

Notes:
In order to achieve optimum shielding results, the mounting surface must be conductive
Marking label: US-EMLP-HA (20X9), Order No. 0830989
¹⁾ Screw locking with M6 Allen screws

Accessories



Cable glands
From page 686



Allen keys
see Catalog 3



Replacement seals
phoenixcontact.net/products

Heavy-duty connectors

HEAVYCON B – housings

Size B6, plastic, EVO housings, single locking latch

General data









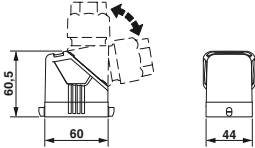

Housing material	PA
Locking latch material	PA
Sealing material	NBR
IP degree of protection (when plugged in)	IP66
NEMA degree of protection (when plugged in)	12
Ambient temperature (operation)	-40°C ... 125°C

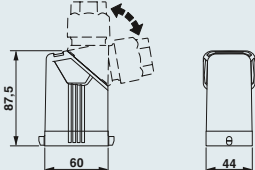
Technical data

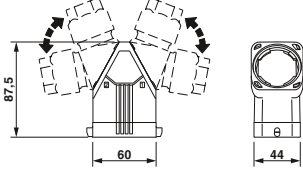
Housing material	PA
Locking latch material	PA
Sealing material	NBR
IP degree of protection (when plugged in)	IP66
NEMA degree of protection (when plugged in)	12
Ambient temperature (operation)	-40°C ... 125°C

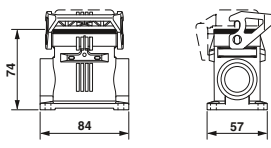

Ordering data

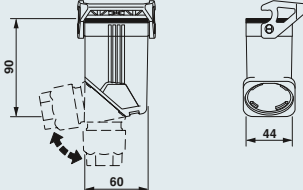
Description	Thread	Type	Order No.	Pcs./Pkt.	Dimensions
Sleeve housing Height: 60.5 mm 		HC-EVO-B06-HLFS-PLBK	1407619	1	
Sleeve housing Height: 87.5 mm 		HC-EVO-B06-HHFS-PLBK	1407620	1	
Double sleeve housing Height: 87.5 mm 		for single locking latch HC-EVO-B06-HHFS-2B-PL-BK	1420930	1	
Panel mounting base Height: 30.5 mm 		Without cover HC-EVO-B06-BWS-PLRBK With cover HC-EVO-B06-BWSC-PLRBK	1407621 1407622	1 1	
Box mounting base ¹⁾ Height: 74 mm 	2x M20 2x M25 2x M32	Without cover HC-EVO-B06-SHWS-2SSM20-PLRBK HC-EVO-B06-SHWS-2SSM25-PLRBK HC-EVO-B06-SHWS-2SSM32-PLRBK With cover HC-EVO-B06-SHWSC-2SSM20-PLRBK HC-EVO-B06-SHWSC-2SSM25-PLRBK HC-EVO-B06-SHWSC-2SSM32-PLRBK	1421322 1421229 1407623 1421329 1421244 1407624	1 1 1 1 1 1	
Coupling housing Height: 90 mm 		HC-EVO-B06-CHWS-PLRBK	1407625	1	

Notes:

For further accessories, see from page 658

Marking label: US-EMP (20X9) Order No. [0829439](#)

¹⁾ One cable entry is sealed with a knockout cover

Accessories



Cable glands
From page 658



Thread adapters
From page 659



Replacement seals
phoenixcontact.net/products



Connector sets
From page 646









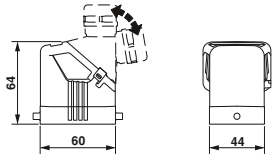

Size B6, metal, EVO housings, single locking latch

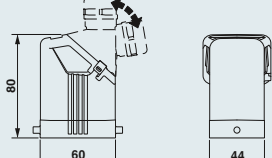

Technical data

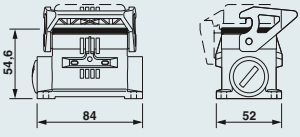
General data	
Housing material	Die-cast aluminum, salt water resistant
Locking latch material	PA
Sealing material	NBR, conductive
IP degree of protection (when plugged in)	IP66 / IP67
NEMA degree of protection (when plugged in)	4 / 4X / 12
Ambient temperature (operation)	-40°C ... 125°C

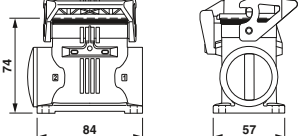
Ordering data

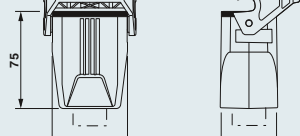
Description	Thread	Type	Order No.	Pcs./Pkt.	Dimensions
Sleeve housing Height: 60.5 mm 		HC-EVO-B06-HLFS-EL-AL	1411448	1	
Sleeve housing Height: 80 mm 		HC-EVO-B06-HHFS-EL-AL	1411447	1	
Panel mounting base Height: 30.5 mm 		Without cover HC-STA-B06-BWS-ELC-AL	1411318	1	
		With cover HC-STA-B06-BWSC-ELC-AL	1411319	1	
Box mounting base¹⁾ Height: 54.6 mm 	2x M20	Without cover HC-STA-B06-SLWS-2SSM20-ELC-AL	1412821	1	
	2x M25	HC-STA-B06-SLWS-2SSM25-ELC-AL	1412822	1	
	2x Pg16	HC-STA-B06-SLWS-2SSP16-ELC-AL	1412823	1	
	2x M20	With cover HC-STA-B06-SLWSC-2SSM20-ELC-AL	1412825	1	
	2x M25	HC-STA-B06-SLWSC-2SSM25-ELC-AL	1412826	1	
	2x Pg16	HC-STA-B06-SLWSC-2SSP16-ELC-AL	1412827	1	
Box mounting base¹⁾ Height: 74.8 mm 	2x M25	Without cover HC-STA-B06-SHWS-2SSM25-ELC-AL	1082556	1	
	2x M32	HC-STA-B06-SHWS-2SSM32-ELC-AL	1082559	1	
	2x M40	HC-STA-B06-SHWS-2SSM40-ELC-AL	1082566	1	
	2x M25	With cover HC-STA-B06-SHWSC-2SSM25-ELC-AL	1082575	1	
	2x M32	HC-STA-B06-SHWSC-2SSM32-ELC-AL	1082576	1	
	2x M40	HC-STA-B06-SHWSC-2SSM40-ELC-AL	1082577	1	
Coupling housing Height: 73 mm 	1x M20	HC-STA-B06-CHWS-1TTM20-ELC-AL	1412555	1	
	1x M25	HC-STA-B06-CHWS-1TTM25-ELC-AL	1412556	1	
	1x M32	HC-STA-B06-CHWS-1TTM32-ELC-AL	1412557	1	
	1x Pg13.5	HC-STA-B06-CHWS-1TTP13-ELC-AL	1412558	1	
	1x Pg21	HC-STA-B06-CHWS-1TTP21-ELC-AL	1412559	1	
	1x Pg29	HC-STA-B06-CHWS-1TTP29-ELC-AL	1412560	1	

Notes:

- For further accessories, see page 658
- Marking label: US-EMLP-HA (20X9), Order No. 0830989
- ¹⁾ Supplied with a plastic sealing cap

Accessories



Cable glands
From page 660



Cable glands
From page 686



Replacement seals
phoenixcontact.net/products



Connector sets
phoenixcontact.net/products

Heavy-duty connectors

HEAVYCON B – housings

Size B6, metal, sleeve housings for single locking latch







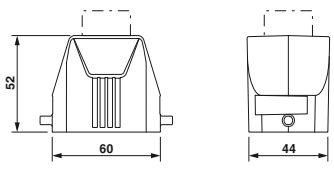

General data

Housing material
Locking latch material
Sealing material
IP degree of protection (when plugged in)
NEMA degree of protection (when plugged in)
Ambient temperature (operation)

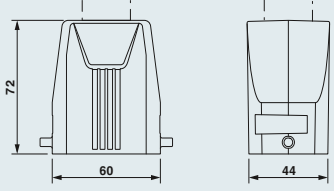
Technical data	
Housing material	Die-cast aluminum, salt water resistant
Locking latch material	-
Sealing material	-
IP degree of protection (when plugged in)	IP66 / IP67
NEMA degree of protection (when plugged in)	4 / 4X / 12
Ambient temperature (operation)	-40°C ... 125°C

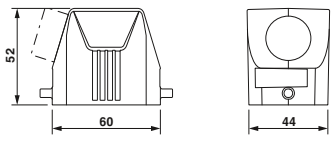
Ordering data

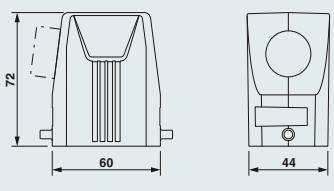
Description	Thread	Type	Order No.	Pcs./Pkt.	Dimensions
Sleeve housing Height: 52 mm 	1x M20 1x M25 1x Pg13.5 1x Pg16	Cable outlet: top			
		HC-STA-B06-HLFS-1TTM20-EL-AL	1412574	1	
		HC-STA-B06-HLFS-1TTM25-EL-AL	1412575	1	
		HC-STA-B06-HLFS-1TTP13-EL-AL	1412576	1	
		HC-STA-B06-HLFS-1TTP16-EL-AL without bore hole	1412577	1	
HC-STA-B06-HLFS-BLANK-EL-AL	1419900	1			
Sleeve housing Height: 72 mm 	1x M25 1x M32 1x Pg21 1x Pg29	Cable outlet: top			
		HC-STA-B06-HHFS-1TTM25-EL-AL	1412566	1	
		HC-STA-B06-HHFS-1TTM32-EL-AL	1412567	1	
		HC-STA-B06-HHFS-1TTP21-EL-AL	1412568	1	
		HC-STA-B06-HHFS-1TTP29-EL-AL without bore hole	1412569	1	
HC-STA-B06-HHFS-BLANK-EL-AL	1419901	1			
Sleeve housing Height: 52 mm 	1x M20 1x M25 1x Pg13.5 1x Pg16	Cable outlet: lateral			
		HC-STA-B06-HLFS-1STM20-EL-AL	1412570	1	
		HC-STA-B06-HLFS-1STM25-EL-AL	1412571	1	
		HC-STA-B06-HLFS-1STP13-EL-AL	1412572	1	
		HC-STA-B06-HLFS-1STP16-EL-AL without bore hole	1412573	1	
HC-STA-B06-HLFS-BLANK-EL-AL	1419900	1			
Sleeve housing Height: 72 mm 	1x M25 1x M32 1x Pg21 1x Pg29	Cable outlet: lateral			
		HC-STA-B06-HHFS-1STM25-EL-AL	1412562	1	
		HC-STA-B06-HHFS-1STM32-EL-AL	1412563	1	
		HC-STA-B06-HHFS-1STP21-EL-AL	1412564	1	
		HC-STA-B06-HHFS-1STP29-EL-AL without bore hole	1412565	1	
HC-STA-B06-HHFS-BLANK-EL-AL	1419901	1			

Notes:
 For further accessories, see from page 658
 Marking label: US-EMLP-HA (20X9), Order No. 0830989

Accessories

 Cable glands From page 686	 Protective covers From page 654	 Cover plates From page 664	 Connector sets From page 647
---	--	---	---

Size B6, metal, supporting base elements with single locking latch



General data		Technical data	
Housing material		Die-cast aluminum, salt water resistant	
Locking latch material		PA	
Sealing material		NBR, conductive	
IP degree of protection (when plugged in)		IP66 / IP67	
NEMA degree of protection (when plugged in)		4 / 4X / 12	
Ambient temperature (operation)		-40°C ... 125°C	

Description		Thread	Type	Order No.	Pcs./Pkt.	Dimensions
Panel mounting base Height: 30.5 mm			Without cover HC-STA-B06-BWS-ELC-AL	1411318	1	
			With cover HC-STA-B06-BWSC-ELC-AL	1411319	1	
Box mounting base¹⁾ Height: 54.6 mm		2x M20 2x M25 2x Pg16	Without cover HC-STA-B06-SLWS-2SSM20-ELC-AL HC-STA-B06-SLWS-2SSM25-ELC-AL HC-STA-B06-SLWS-2SSP16-ELC-AL	1412821 1412822 1412823	1 1 1	
		2x M20 2x M25 2x Pg16	With cover HC-STA-B06-SLWSC-2SSM20-ELC-AL HC-STA-B06-SLWSC-2SSM25-ELC-AL HC-STA-B06-SLWSC-2SSP16-ELC-AL	1412825 1412826 1412827	1 1 1	
		2x M25 2x M32 2x M40	Without cover HC-STA-B06-SHWS-2SSM25-ELC-AL HC-STA-B06-SHWS-2SSM32-ELC-AL HC-STA-B06-SHWS-2SSM40-ELC-AL	1082556 1082559 1082566	1 1 1	
Box mounting base¹⁾ Height: 74.8 mm		2x M25 2x M32 2x M40	With cover HC-STA-B06-SHWSC-2SSM25-ELC-AL HC-STA-B06-SHWSC-2SSM32-ELC-AL HC-STA-B06-SHWSC-2SSM40-ELC-AL	1082575 1082576 1082577	1 1 1	
Coupling housing Height: 73 mm		1x M20 1x M25 1x M32 1x Pg13.5 1x Pg21 1x Pg29	Cable outlet: top HC-STA-B06-CHWS-1TTM20-ELC-AL HC-STA-B06-CHWS-1TTM25-ELC-AL HC-STA-B06-CHWS-1TTM32-ELC-AL HC-STA-B06-CHWS-1TTP13-ELC-AL HC-STA-B06-CHWS-1TTP21-ELC-AL HC-STA-B06-CHWS-1TTP29-ELC-AL	1412555 1412556 1412557 1412558 1412559 1412560	1 1 1 1 1 1	

Notes:
For further accessories, see from page 658
¹⁾ Supplied with a plastic sealing cap

Accessories



Cable glands
From page 686



Replacement seals
phoenixcontact.net/products



Replacement protective covers
phoenixcontact.net/products



Replacement latches
phoenixcontact.net/products

Heavy-duty connectors

HEAVYCON B – housings

Size B10, plastic, ADVANCE PL sleeve housings with cable gland

General data







Housing material	PA
Lock material	Stainless steel
Sealing material	NBR
IP degree of protection (when plugged in)	IP66 / IP67
NEMA degree of protection (when plugged in)	12
Ambient temperature (operation)	-40°C ... 100°C

Technical data

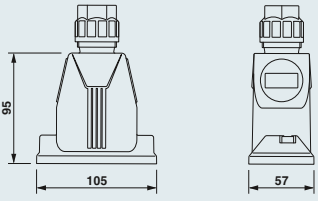
PA
Stainless steel
NBR
IP66 / IP67
12
-40°C ... 100°C

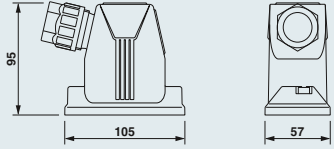

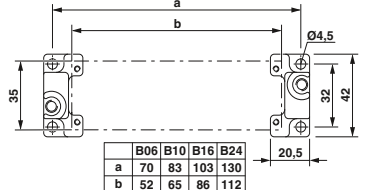
Ordering data

Description	Clamping area	Type	Order No.	Pcs./Pkt.	Dimensions															
Sleeve housing¹⁾ Height: 95 mm 	9 mm ... 17 mm 11 mm ... 21 mm	Cable outlet: top HC-ADV-B10-HHWH-1TGM25-PL HC-ADV-B10-HHWH-1TGM32-PL	1404227 1404229	1 1																
Sleeve housing¹⁾ Height: 95 mm 	9 mm ... 17 mm 11 mm ... 21 mm	Cable outlet: lateral HC-ADV-B10-HHWH-1SGM25-PL HC-ADV-B10-HHWH-1SGM32-PL	1404228 1404230	1 1																
Panel mounting flange 		2 pcs. per housing HC-B-AF Set with 2 panel mounting flanges HC-B-AF-SET	1686533 1604638	20 1	 <table border="1" data-bbox="1204 1533 1356 1585"> <thead> <tr> <th></th> <th>B06</th> <th>B10</th> <th>B16</th> <th>B24</th> </tr> </thead> <tbody> <tr> <td>a</td> <td>70</td> <td>83</td> <td>103</td> <td>130</td> </tr> <tr> <td>b</td> <td>52</td> <td>65</td> <td>86</td> <td>112</td> </tr> </tbody> </table>		B06	B10	B16	B24	a	70	83	103	130	b	52	65	86	112
	B06	B10	B16	B24																
a	70	83	103	130																
b	52	65	86	112																
Protective cover Height: 31.2 mm 		for sleeve side, IP50 HC-B 10-TMS-SD-IP50 for panel mounting side, IP66 HC-B 10-TMS-SD-IP66	1690749 1411504	10 10																

Notes:

Marking label: US-EMP (20X9) Order No. [0829439](#)

¹⁾ Screw locking with M6 Allen screws

Accessories



Allen keys
see Catalog 3



Replacement seals
phoenixcontact.net/products



Corrugated pipe adapters
see Catalog 3

Size B10, metal, ADVANCE sleeve housings











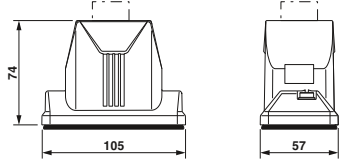

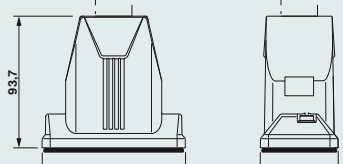
General data	
Housing material	Die-cast aluminum, salt water resistant
Surface material	uncoated / powder coated, black
Lock material	Stainless steel
Sealing material	NBR, conductive / Viton
IP degree of protection (when plugged in)	IP66 / IP68 / IP69K
NEMA degree of protection (when plugged in)	4 / 4X / 12
Ambient temperature (operation)	-40°C ... 125°C

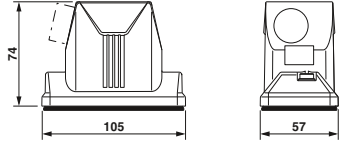
Technical data

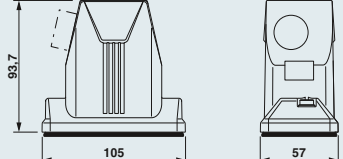
Die-cast aluminum, salt water resistant
uncoated / powder coated, black
Stainless steel
NBR, conductive / Viton
IP66 / IP68 / IP69K
4 / 4X / 12
-40°C ... 125°C

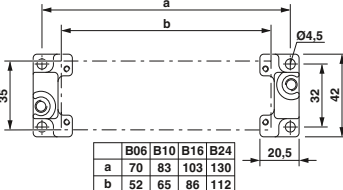
Ordering data

Description	Thread	Type	Order No.	Pcs./Pkt.	Dimensions															
Sleeve housing, cable outlet: top¹⁾ Height: 74 mm 	1x M20	Uncoated, EMC ready HC-ADV-B10-HLWH-1TTM20-EMC-AL	1413388	1																
	1x M25	Uncoated, EMC ready HC-ADV-B10-HLWH-1TTM25-EMC-AL	1413390	1																
		Uncoated, EMC ready, without drill hole HC-ADV-B10-HLWH-BLANK-ELC-AL	1420051	1																
	1x M20	Powder-coated, black HC-ADV-B10-HLWH-1TTM20-MF-BK	1420912	1																
	1x M25	Powder-coated, black HC-ADV-B10-HLWH-1TTM25-MF-BK	1420913	1																
Sleeve housing, cable outlet: top¹⁾ Height: 93.7 mm 	1x M25	Uncoated, EMC ready HC-ADV-B10-HHWH-1TTM25-EMC-AL	1413400	1																
	1x M32	Uncoated, EMC ready HC-ADV-B10-HHWH-1TTM32-EMC-AL	1413402	1																
		Uncoated, EMC ready, without drill hole HC-ADV-B10-HHWH-BLANK-ELC-AL	1420052	1																
	1x M25	Powder-coated, black HC-ADV-B10-HHWH-1TTM25-MF-BK	1420908	1																
	1x M32	Powder-coated, black HC-ADV-B10-HHWH-1TTM32-MF-BK	1420909	1																
Sleeve housing, cable outlet: to the side¹⁾ Height: 74 mm 	1x M20	Uncoated, EMC ready HC-ADV-B10-HLWH-1STM20-EMC-AL	1413389	1																
	1x M25	Uncoated, EMC ready HC-ADV-B10-HLWH-1STM25-EMC-AL	1413391	1																
		Uncoated, EMC ready, without drill hole HC-ADV-B10-HLWH-BLANK-ELC-AL	1420051	1																
	1x M20	Powder-coated, black HC-ADV-B10-HLWH-1STM20-MF-BK	1420910	1																
	1x M25	Powder-coated, black HC-ADV-B10-HLWH-1STM25-MF-BK	1420911	1																
Sleeve housing, cable outlet: to the side¹⁾ Height: 93.7 mm 	1x M25	Uncoated, EMC ready HC-ADV-B10-HHWH-1STM25-EMC-AL	1413401	1																
	1x M32	Uncoated, EMC ready HC-ADV-B10-HHWH-1STM32-EMC-AL	1413403	1																
		Uncoated, EMC ready, without drill hole HC-ADV-B10-HHWH-BLANK-ELC-AL	1420052	1																
	1x M25	Powder-coated, black HC-ADV-B10-HHWH-1STM25-MF-BK	1420906	1																
	1x M32	Powder-coated, black HC-ADV-B10-HHWH-1STM32-MF-BK	1420907	1																
Panel mounting flange 		2 pcs. per housing HC-B-AF Set with 2 panel mounting flanges HC-B-AF-SET	1686533 1604638	20 1	 <table border="1" data-bbox="1189 1533 1340 1585"> <tr> <td></td> <td>B06</td> <td>B10</td> <td>B16</td> <td>B24</td> </tr> <tr> <td>a</td> <td>70</td> <td>83</td> <td>103</td> <td>130</td> </tr> <tr> <td>b</td> <td>52</td> <td>65</td> <td>86</td> <td>112</td> </tr> </table>		B06	B10	B16	B24	a	70	83	103	130	b	52	65	86	112
	B06	B10	B16	B24																
a	70	83	103	130																
b	52	65	86	112																
Protective cover Height: 31.2 mm 		for sleeve side, IP50 HC-B 10-TMS-SD-IP50 for panel mounting side, IP66 HC-B 10-TMS-SD-IP66	1690749 1411504	10 10																

Notes:
In order to achieve optimum shielding results, the mounting surface must be conductive
Marking label: US-EMLP-HA (20X9), Order No. 0830989
¹⁾ Screw locking with M6 Allen screws

Accessories

 Screw connections From page 686	 Allen keys see Catalog 3	 Replacement seals phoenixcontact.net/products
--	---	---

Heavy-duty connectors

HEAVYCON B – housings

Size B10, plastic, EVO housings, single locking latch

General data

Housing material	PA
Locking latch material	PA
Sealing material	NBR
IP degree of protection (when plugged in)	IP66
NEMA degree of protection (when plugged in)	12
Ambient temperature (operation)	-40°C ... 125°C

Technical data



Ordering data

Description	Thread	Type	Order No.	Pcs./Pkt.	Dimensions
Sleeve housing Height: 60.5 mm		HC-EVO-B10-HLFS-PLBK	1407626	1	
Sleeve housing Height: 87.5 mm		HC-EVO-B10-HHFS-PLBK	1407627	1	
Panel mounting base Height: 30.5 mm		Without cover HC-EVO-B10-BWS-PLRBK	1407632	1	
		With cover HC-EVO-B10-BWSC-PLRBK	1407633	1	
Box mounting base ¹⁾ Height: 74 mm	2x M20 2x M25 2x M32	Without cover HC-EVO-B10-SHWS-2SSM20-PLRBK	1421354	1	
		HC-EVO-B10-SHWS-2SSM25-PLRBK	1421277	1	
		HC-EVO-B10-SHWS-2SSM32-PLRBK	1407636	1	
		With cover HC-EVO-B10-SHWSC-2SSM20-PLRBK	1421355	1	
		HC-EVO-B10-SHWSC-2SSM25-PLRBK	1421301	1	
HC-EVO-B10-SHWSC-2SSM32-PLRBK	1407637	1			
Coupling housing Height: 90 mm		HC-EVO-B10-CHWS-PLRBK	1407640	1	
Cable gland	Clamping area 7 mm ... 13 mm 9 mm ... 17 mm 11 mm ... 21 mm 19 mm ... 28 mm	HC-B-G-M20-PLRBK	1407669	1	
		HC-B-G-M25-PLRBK	1407670	1	
		HC-B-G-M32-PLRBK	1407671	1	
		HC-B-G-M40-PLRBK	1407672	1	

Notes:

For further accessories, see from page 658

Marking label: US-EMP (20X9) Order No. 0829439

¹⁾ One cable entry is sealed with a knockout cover

Accessories



EVO unlocking tools
From page 659



Thread adapters
From page 659



Replacement seals
phoenixcontact.net/products











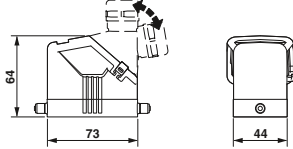

Connector sets
From page 646

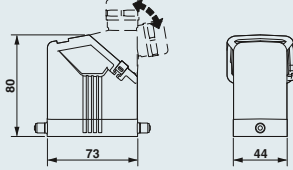
Size B10, metal, EVO housings, single locking latch

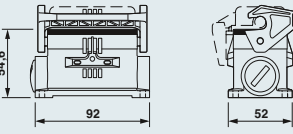

General data	
Housing material	Die-cast aluminum, salt water resistant
Locking latch material	PA
Sealing material	NBR, conductive
IP degree of protection (when plugged in)	IP66 / IP67
NEMA degree of protection (when plugged in)	4 / 4X / 12
Ambient temperature (operation)	-40°C ... 125°C

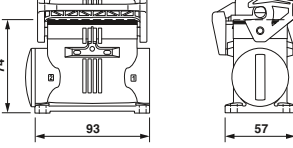
Technical data	
Housing material	Die-cast aluminum, salt water resistant
Locking latch material	PA
Sealing material	NBR, conductive
IP degree of protection (when plugged in)	IP66 / IP67
NEMA degree of protection (when plugged in)	4 / 4X / 12
Ambient temperature (operation)	-40°C ... 125°C

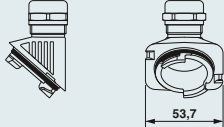
Description		Thread	Type	Order No.	Pcs./Pkt.	Dimensions
Sleeve housing Height: 64 mm 			HC-EVO-B10-HLFS-EL-AL	1411456	1	
Sleeve housing Height: 80 mm 			HC-EVO-B10-HHFS-EL-AL	1411453	1	
Panel mounting base Height: 30.5 mm 			Without cover HC-STA-B10-BWS-ELC-AL With cover HC-STA-B10-BWSC-ELC-AL	1411320 1411321	1 1	
Box mounting base¹⁾ Height: 54.6 mm 		2x M20 2x M25 2x Pg16	Without cover HC-STA-B10-SLWS-2SSM20-ELC-AL HC-STA-B10-SLWS-2SSM25-ELC-AL HC-STA-B10-SLWS-2SSP16-ELC-AL With cover HC-STA-B10-SLWSC-2SSM20-ELC-AL HC-STA-B10-SLWSC-2SSM25-ELC-AL HC-STA-B10-SLWSC-2SSP16-ELC-AL	1412839 1412840 1412842 1412844 1412845 1412846	1 1 1 1 1 1	
Box mounting base¹⁾ Height: 74.5 mm 		2x M25 2x M32 2x M40 2x M25 2x M32 2x M40	Without cover HC-STA-B10-SHWS-2SSM25-ELC-AL HC-STA-B10-SHWS-2SSM32-ELC-AL HC-STA-B10-SHWS-2SSM40-ELC-AL With cover HC-STA-B10-SHWSC-2SSM25-ELC-AL HC-STA-B10-SHWSC-2SSM32-ELC-AL HC-STA-B10-SHWSC-2SSM40-ELC-AL	1082578 1082579 1082580 1082582 1082583 1082585	1 1 1 1 1 1	
Cable gland 		Clamping area 9 mm ... 13 mm 11 mm ... 16 mm 14 mm ... 21 mm 19 mm ... 27 mm	HC-B-G-M20-EC-AL HC-B-G-M25-EC-AL HC-B-G-M32-EC-AL HC-B-G-M40-EC-AL	1411439 1411446 1411440 1411441	1 1 1 1	

Notes:
For further accessories, see page 658
Marking label: US-EMLP-HA (20X9), Order No. 0830989
¹⁾ Supplied with a plastic sealing cap

Ordering data		
Type	Order No.	Pcs./Pkt.

Accessories

 Thread adapters From page 660	 EMC cable glands From page 660	 Replacement seals phoenixcontact.net/products	 Connector sets phoenixcontact.net/products
--	---	---	--

Heavy-duty connectors

HEAVYCON B – housings

Size B10, metal, sleeve housings for single locking latch







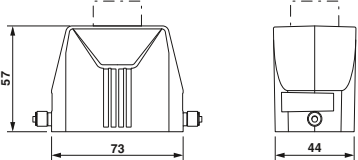

General data

Housing material
Locking latch material
Sealing material
IP degree of protection (when plugged in)
NEMA degree of protection (when plugged in)
Ambient temperature (operation)

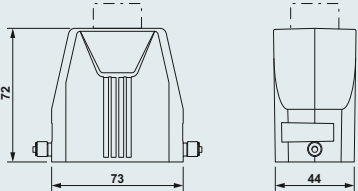
Technical data	
Die-cast aluminum, salt water resistant	
-	
-	
IP66 / IP67	
4 / 4X / 12	
-40°C ... 125°C	

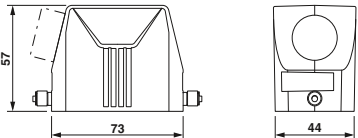
Ordering data

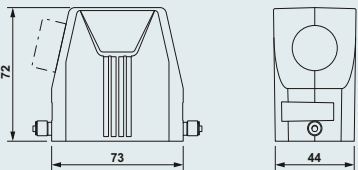
Description	Thread	Type	Order No.	Pcs./Pkt.	Dimensions
Sleeve housing Height: 57 mm 	1x M20 1x M25 1x Pg16 1x Pg21	Cable outlet: top			
		HC-STA-B10-HLFS-1TTM20-EL-AL	1412629	1	
		HC-STA-B10-HLFS-1TTM25-EL-AL	1412630	1	
		HC-STA-B10-HLFS-1TTP16-EL-AL	1412631	1	
		HC-STA-B10-HLFS-1TTP21-EL-AL without bore hole	1412632	1	
HC-STA-B10-HLFS-BLANK-EL-AL	1419902	1			
Sleeve housing Height: 72 mm 	1x M25 1x M32 1x Pg21 1x Pg29	Cable outlet: top			
		HC-STA-B10-HHFS-1TTM25-EL-AL	1412604	1	
		HC-STA-B10-HHFS-1TTM32-EL-AL	1412605	1	
		HC-STA-B10-HHFS-1TTP21-EL-AL	1412606	1	
		HC-STA-B10-HHFS-1TTP29-EL-AL without bore hole	1412607	1	
HC-STA-B10-HHFS-BLANK-EL-AL	1419903	1			
Sleeve housing Height: 57 mm 	1x M20 1x M25 1x Pg16 1x Pg21	Cable outlet: lateral			
		HC-STA-B10-HLFS-1STM20-EL-AL	1412624	1	
		HC-STA-B10-HLFS-1STM25-EL-AL	1412625	1	
		HC-STA-B10-HLFS-1STP16-EL-AL	1412627	1	
		HC-STA-B10-HLFS-1STP21-EL-AL without bore hole	1412628	1	
HC-STA-B10-HLFS-BLANK-EL-AL	1419902	1			
Sleeve housing Height: 72 mm 	1x M25 1x M32 1x Pg21 1x Pg29	Cable outlet: lateral			
		HC-STA-B10-HHFS-1STM25-EL-AL	1412600	1	
		HC-STA-B10-HHFS-1STM32-EL-AL	1412601	1	
		HC-STA-B10-HHFS-1STP21-EL-AL	1412602	1	
		HC-STA-B10-HHFS-1STP29-EL-AL without bore hole	1412603	1	
HC-STA-B10-HHFS-BLANK-EL-AL	1419903	1			

Notes:
For further accessories, see from page 658
Marking label: US-EMLP-HA (20X9), Order No. 0830989

Accessories

 Cable glands From page 686	 Protective covers From page 654	 Cover plates From page 664	 Connector sets From page 647
---	--	---	---

Size B10, metal, supporting base elements with single locking latch



General data		Technical data	
Housing material		Die-cast aluminum, salt water resistant	
Locking latch material		PA	
Sealing material		NBR, conductive	
IP degree of protection (when plugged in)		IP66 / IP67	
NEMA degree of protection (when plugged in)		4 / 4X / 12	
Ambient temperature (operation)		-40°C ... 125°C	

Description		Thread	Type	Order No.	Pcs./Pkt.	Dimensions	
Panel mounting base Height: 30.5 mm			Without cover				
			HC-STA-B10-BWS-ELC-AL	1411320	1		
Box mounting base ¹⁾ Height: 54.6 mm		2x M20 2x M25 2x Pg16	Without cover				
			HC-STA-B10-SLWS-2SSM20-ELC-AL	1412839	1		
			HC-STA-B10-SLWS-2SSM25-ELC-AL	1412840	1		
			HC-STA-B10-SLWS-2SSP16-ELC-AL	1412842	1		
			With cover				
			HC-STA-B10-SLWSC-2SSM20-ELC-AL	1412844	1		
Box mounting base ¹⁾ Height: 74.5 mm		2x M25 2x M32 2x M40	Without cover				
			HC-STA-B10-SHWS-2SSM25-ELC-AL	1082578	1		
			HC-STA-B10-SHWS-2SSM32-ELC-AL	1082579	1		
			HC-STA-B10-SHWS-2SSM40-ELC-AL	1082580	1		
			With cover				
			HC-STA-B10-SHWSC-2SSM25-ELC-AL	1082582	1		
Coupling housing Height: 73 mm		1x M20 1x M25 1x M32 1x Pg16 1x Pg21 1x Pg29	Cable outlet: top				
			HC-STA-B10-CHWS-1TTM20-ELC-AL	1412584	1		
			HC-STA-B10-CHWS-1TTM25-ELC-AL	1412585	1		
			HC-STA-B10-CHWS-1TTM32-ELC-AL	1412586	1		
			HC-STA-B10-CHWS-1TTP16-ELC-AL	1412587	1		
			HC-STA-B10-CHWS-1TTP21-ELC-AL	1412588	1		
HC-STA-B10-CHWS-1TTP29-ELC-AL	1412589	1					

Notes:
For further accessories, see from page 658
1) Supplied with a plastic sealing cap

Accessories



Cable glands
From page 686



Replacement seals
phoenixcontact.net/products



Replacement protective covers
phoenixcontact.net/products



Replacement latches
phoenixcontact.net/products

Heavy-duty connectors

HEAVYCON B – housings

Size B10, plastic, EVO housings, double locking latch



General data

Housing material	PA
Locking latch material	PA
Sealing material	NBR
IP degree of protection (when plugged in)	IP66
NEMA degree of protection (when plugged in)	12
Ambient temperature (operation)	-40°C ... 125°C

Technical data

Ordering data

Description	Thread
-------------	--------

Sleeve housing Height: 60.5 mm	
-----------------------------------	--



Sleeve housing Height: 87.5 mm	
-----------------------------------	--



Double sleeve housing Height: 87.5 mm	
--	--



Panel mounting base Height: 30.5 mm	
--	--



Box mounting base ¹⁾ Height: 74 mm	2x M20 2x M25 2x M32
--	----------------------------



Coupling housing Height: 90 mm	
-----------------------------------	--



Type	Order No.	Pcs./Pkt.
HC-EVO-B10-HLFD-PLBK	1407628	1
HC-EVO-B10-HHFD-PLBK	1407629	1
for double locking latch HC-EVO-B10-HHFD-2B-PL-BK	1411495	1
Without cover HC-EVO-B10-BWD-PLRBK	1407634	1
Without cover HC-EVO-B10-SHWD-2SSM20-PLRBK	1421356	1
HC-EVO-B10-SHWD-2SSM25-PLRBK	1421304	1
HC-EVO-B10-SHWD-2SSM32-PLRBK	1407638	1
HC-EVO-B10-CHWD-PLRBK	1407641	1

Dimensions

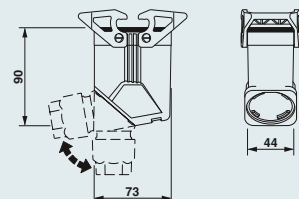
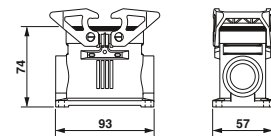
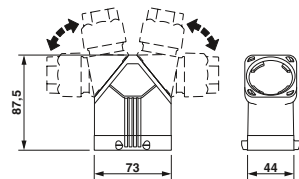
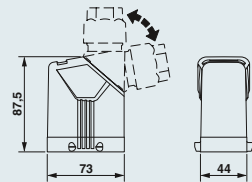
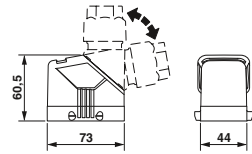

Notes:

- For further accessories, see from page 658
- Marking label: US-EMP (20X9) Order No. [0829439](#)
- For coupling housings, visit phoenixcontact.net/products
- ¹⁾ One cable entry is sealed with a knockout cover

Accessories



Cable glands
From page 658



Thread adapters
From page 659



Replacement seals
phoenixcontact.net/products



Connector sets
From page 646

Size B10, metal, EVO housings, double locking latch











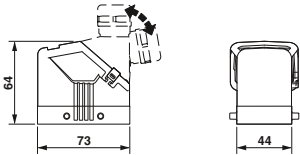

Technical data

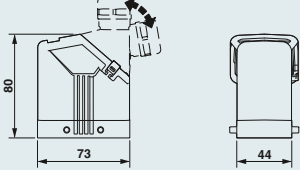
General data

Housing material
Locking latch material
Sealing material
IP degree of protection (when plugged in)
NEMA degree of protection (when plugged in)
Ambient temperature (operation)

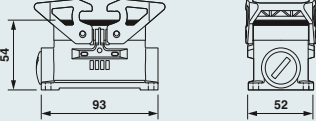
Die-cast aluminum, salt water resistant
PA
NBR, conductive
IP66 / IP67
4 / 4X / 12
-40°C ... 125°C

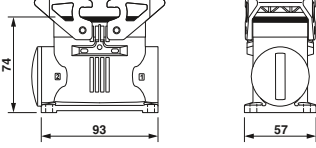
Ordering data

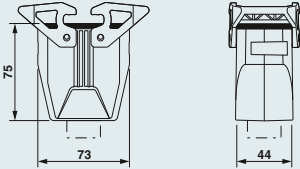
Description	Thread	Type	Order No.	Pcs./Pkt.	Dimensions
Sleeve housing Height: 64 mm 		HC-EVO-B10-HLFD-EL-AL	1411455	1	
Sleeve housing Height: 80 mm 		HC-EVO-B10-HHFD-EL-AL	1411451	1	
Panel mounting base Height: 30.5 mm 		Without cover HC-STA-B10-BWD-ELC-AL	1411322	1	
Box mounting base¹⁾ Height: 54 mm 	2x M20 2x M25 2x Pg16	Without cover HC-STA-B10-SLWD-2SSM20-ELC-AL HC-STA-B10-SLWD-2SSM25-ELC-AL HC-STA-B10-SLWD-2SSP16-ELC-AL	1412835 1412836 1412837	1 1 1	
Box mounting base¹⁾ Height: 74.5 mm 	2x M25 2x M32 2x M40	Without cover HC-STA-B10-SHWD-2SSM25-ELC-AL HC-STA-B10-SHWD-2SSM32-ELC-AL HC-STA-B10-SHWD-2SSM40-ELC-AL	1082598 1082599 1083164	1 1 1	
Coupling housing Height: 73 mm 	1x M20 1x M25 1x M32 1x Pg16 1x Pg21 1x Pg29	Cable outlet: top HC-STA-B10-CHWD-1TTM20-ELC-AL HC-STA-B10-CHWD-1TTM25-ELC-AL HC-STA-B10-CHWD-1TTM32-ELC-AL HC-STA-B10-CHWD-1TTP16-ELC-AL HC-STA-B10-CHWD-1TTP21-ELC-AL HC-STA-B10-CHWD-1TTP29-ELC-AL	1412578 1412579 1412580 1412581 1412582 1412583	1 1 1 1 1 1	

Notes:

For further accessories, see page 658
Marking label: US-EMLP-HA (20X9), Order No. 0830989
¹⁾ Supplied with a plastic sealing cap

Accessories



Cable glands
From page 660



Cable glands
From page 686



Replacement seals
phoenixcontact.net/products



Connector sets
phoenixcontact.net/products

Heavy-duty connectors

HEAVYCON B – housings

Size B10, metal, sleeve housings for double locking latch



General data

Housing material	Die-cast aluminum, salt water resistant
Locking latch material	-
Sealing material	-
IP degree of protection (when plugged in)	IP66 / IP67
NEMA degree of protection (when plugged in)	4 / 4X / 12
Ambient temperature (operation)	-40°C ... 125°C

Technical data

Ordering data

Description

Thread

Type

Order No.

Pcs./Pkt.

Dimensions

Sleeve housing Height: 57 mm



1x M20	
1x M25	
1x Pg16	
1x Pg21	

Cable outlet: top	
HC-STA-B10-HLFD-1TTM20-EL-AL	1412620
HC-STA-B10-HLFD-1TTM25-EL-AL	1412621
HC-STA-B10-HLFD-1TTP16-EL-AL	1412622
HC-STA-B10-HLFD-1TTP21-EL-AL	1412623
without bore hole	
HC-STA-B10-HLFD-BLANK-EL-AL	1419972

1	
1	
1	
1	
1	
1	

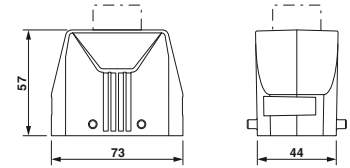

Sleeve housing Height: 72 mm



1x M25	
1x M32	
1x Pg21	
1x Pg29	

Cable outlet: top	
HC-STA-B10-HHFD-1TTM25-EL-AL	1412596
HC-STA-B10-HHFD-1TTP32-EL-AL	1412597
HC-STA-B10-HHFD-1TTP21-EL-AL	1412598
HC-STA-B10-HHFD-1TTP29-EL-AL	1412599
without bore hole	
HC-STA-B10-HHFD-BLANK-EL-AL	1419979

1	
1	
1	
1	
1	
1	

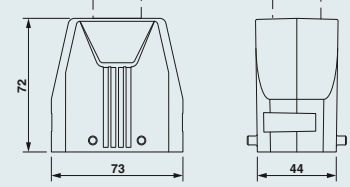

Sleeve housing Height: 57 mm



1x M20	
1x M25	
1x Pg16	
1x Pg21	

Cable outlet: lateral	
HC-STA-B10-HLFD-1STM20-EL-AL	1412616
HC-STA-B10-HLFD-1STM25-EL-AL	1412617
HC-STA-B10-HLFD-1STP16-EL-AL	1412618
HC-STA-B10-HLFD-1STP21-EL-AL	1412619
without bore hole	
HC-STA-B10-HLFD-BLANK-EL-AL	1419972

1	
1	
1	
1	
1	
1	

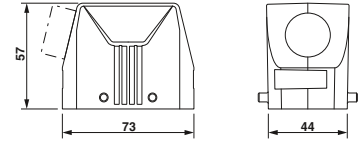

Sleeve housing Height: 72 mm



1x M25	
1x M32	
1x Pg21	
1x Pg29	

Cable outlet: lateral	
HC-STA-B10-HHFD-1STM25-EL-AL	1412592
HC-STA-B10-HHFD-1STM32-EL-AL	1412593
HC-STA-B10-HHFD-1STP21-EL-AL	1412594
HC-STA-B10-HHFD-1STP29-EL-AL	1412595
without bore hole	
HC-STA-B10-HHFD-BLANK-EL-AL	1419979

1	
1	
1	
1	
1	
1	

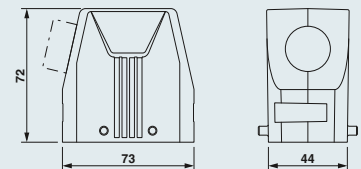

Notes:

For further accessories, see from page 658
Marking label: US-EMLP-HA (20X9), Order No. 0830989

Accessories



Cable glands
From page 686



Protective covers
From page 654



Cover plates
From page 664



Connector sets
From page 647

Size B10, metal, supporting base elements with double locking latch



General data		Technical data	
Housing material		Die-cast aluminum, salt water resistant	
Locking latch material		PA	
Sealing material		NBR, conductive	
IP degree of protection (when plugged in)		IP66 / IP67	
NEMA degree of protection (when plugged in)		4 / 4X / 12	
Ambient temperature (operation)		-40°C ... 125°C	

Description		Thread	Type	Order No.	Pcs./Pkt.	Dimensions
Panel mounting base Height: 30.5 mm			Without cover HC-STA-B10-BWD-ELC-AL	1411322	1	
Box mounting base ¹⁾ Height: 54 mm		2x M20 2x M25 2x Pg16	Without cover HC-STA-B10-SLWD-2SSM20-ELC-AL HC-STA-B10-SLWD-2SSM25-ELC-AL HC-STA-B10-SLWD-2SSP16-ELC-AL	1412835 1412836 1412837	1 1 1	
Box mounting base ¹⁾ Height: 74.5 mm		2x M25 2x M32 2x M40	Without cover HC-STA-B10-SHWD-2SSM25-ELC-AL HC-STA-B10-SHWD-2SSM32-ELC-AL HC-STA-B10-SHWD-2SSM40-ELC-AL	1082598 1082599 1083164	1 1 1	
Coupling housing Height: 73 mm		1x M20 1x M25 1x M32 1x Pg16 1x Pg21 1x Pg29	Cable outlet: top HC-STA-B10-CHWD-1TTM20-ELC-AL HC-STA-B10-CHWD-1TTM25-ELC-AL HC-STA-B10-CHWD-1TTM32-ELC-AL HC-STA-B10-CHWD-1TTP16-ELC-AL HC-STA-B10-CHWD-1TTP21-ELC-AL HC-STA-B10-CHWD-1TTP29-ELC-AL	1412578 1412579 1412580 1412581 1412582 1412583	1 1 1 1 1 1	

Notes:
For further accessories, see from page 658
¹⁾ Supplied with a plastic sealing cap

Accessories



Cable glands
From page 686



Replacement seals
phoenixcontact.net/products



Replacement protective covers
phoenixcontact.net/products



Replacement latches
phoenixcontact.net/products

Heavy-duty connectors

HEAVYCON B – housings

Size B10, plastic, EVO housings, double locking latch









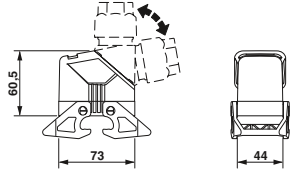

General data

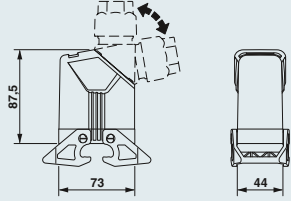
Housing material	PA
Locking latch material	PA
Sealing material	NBR
IP degree of protection (when plugged in)	IP66
NEMA degree of protection (when plugged in)	12
Ambient temperature (operation)	-40°C ... 125°C

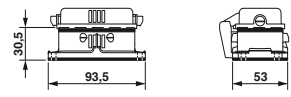
Technical data

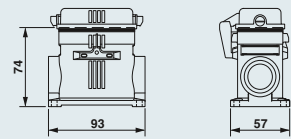
Ordering data

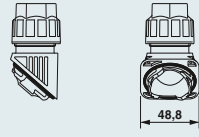
Description	Thread	Type	Order No.	Pcs./Pkt.	Dimensions
Sleeve housing Height: 60.5 mm 		HC-EVO-B10-HLWD-PLBK	1407630	1	
Sleeve housing Height: 87.5 mm 		HC-EVO-B10-HHWD-PLBK	1407631	1	
Panel mounting base Height: 30.5 mm 		With cover HC-EVO-B10-BFDC-PLRBK	1407635	1	
Box mounting base¹⁾ Height: 74 mm 	2x M20 2x M25 2x M32	With cover HC-EVO-B10-SHFDC-2SSM20-PLRBK HC-EVO-B10-SHFDC-2SSM25-PLRBK HC-EVO-B10-SHFDC-2SSM32-PLRBK	1421362 1421320 1407639	1 1 1	
Cable gland 	Clamping area 7 mm ... 13 mm 9 mm ... 17 mm 11 mm ... 21 mm 19 mm ... 28 mm	HC-B-G-M20-PLRBK HC-B-G-M25-PLRBK HC-B-G-M32-PLRBK HC-B-G-M40-PLRBK	1407669 1407670 1407671 1407672	1 1 1 1	

Notes:

For further accessories, see from page 658

Marking label: US-EMP (20X9) Order No. 0829439

¹⁾ One cable entry is sealed with a knockout cover

Accessories



EVO unlocking tools
From page 659



Thread adapters
From page 659



Replacement seals
phoenixcontact.net/products



Replacement latches
phoenixcontact.net/products









Size B10, metal, EVO housings, double locking latch

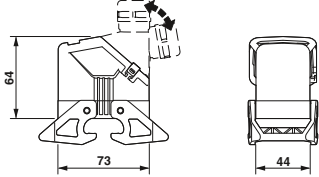

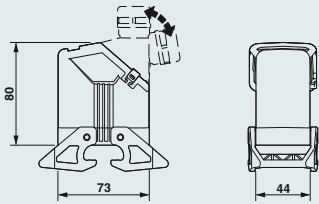
Technical data

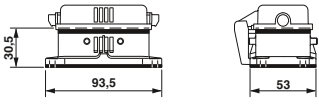
General data	
Housing material	Die-cast aluminum, salt water resistant
Locking latch material	PA
Sealing material	NBR, conductive
IP degree of protection (when plugged in)	IP66 / IP67
NEMA degree of protection (when plugged in)	4 / 4X / 12
Ambient temperature (operation)	-40°C ... 125°C

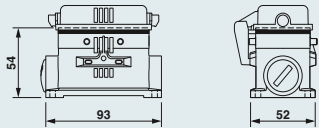
Ordering data

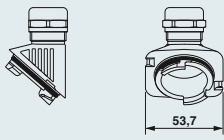
Description	Thread	Type	Order No.	Pcs./Pkt.	Dimensions
Sleeve housing Height: 64 mm 		HC-EVO-B10-HLWD-EL-AL	1411457	1	
Sleeve housing Height: 80 mm 		HC-EVO-B10-HHWD-EL-AL	1411454	1	
Panel mounting base Height: 30.5 mm 		With cover HC-STA-B10-BFDC-ELC-AL	1411323	1	
Box mounting base¹⁾ Height: 54 mm 	2x M20 2x M25 2x Pg16	With cover HC-STA-B10-SLFDC-2SSM20-ELC-AL HC-STA-B10-SLFDC-2SSM25-ELC-AL HC-STA-B10-SLFDC-2SSP16-ELC-AL	1412830 1412831 1412832	1 1 1	
Cable gland 	Clamping area 9 mm ... 13 mm 11 mm ... 16 mm 14 mm ... 21 mm 19 mm ... 27 mm	HC-B-G-M20-EC-AL HC-B-G-M25-EC-AL HC-B-G-M32-EC-AL HC-B-G-M40-EC-AL	1411439 1411446 1411440 1411441	1 1 1 1	

Notes:

- For further accessories, see page 658
- Marking label: US-EMLP-HA (20X9), Order No. 0830989
- ¹⁾ Supplied with a plastic sealing cap

Accessories



Thread adapters
From page 660



EMC cable glands
From page 660



Replacement seals
phoenixcontact.net/products



Replacement latches
phoenixcontact.net/products

Heavy-duty connectors

HEAVYCON B – housings

Size B10, metal, sleeve housings with double locking latch







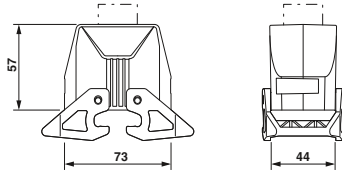

General data

Housing material	Die-cast aluminum, salt water resistant
Locking latch material	PA
Sealing material	-
IP degree of protection (when plugged in)	IP66 / IP67
NEMA degree of protection (when plugged in)	4 / 4X / 12
Ambient temperature (operation)	-40°C ... 125°C

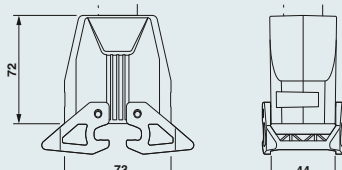
Technical data

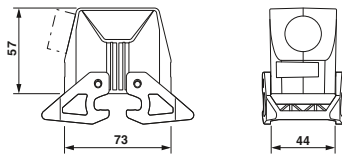
Ordering data

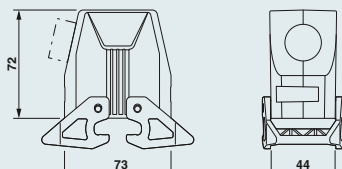
Description	Thread	Type	Order No.	Pcs./Pkt.	Dimensions
Sleeve housing Height: 57 mm 	1x M20	Cable outlet: top HC-STA-B10-HLWD-1TTM20-EL-AL	1412637	1	
	1x M25	HC-STA-B10-HLWD-1TTM25-EL-AL	1412638	1	
	1x Pg16	HC-STA-B10-HLWD-1TTP16-EL-AL	1412639	1	
	1x Pg21	HC-STA-B10-HLWD-1TTP21-EL-AL	1412640	1	
		without bore hole HC-STA-B10-HLWD-BLANK-EL-AL	1420034	1	
Sleeve housing Height: 72 mm 	1x M25	Cable outlet: top HC-STA-B10-HHWD-1TTM25-EL-AL	1412612	1	
	1x M32	HC-STA-B10-HHWD-1TTM32-EL-AL	1412613	1	
	1x Pg21	HC-STA-B10-HHWD-1TTP21-EL-AL	1412614	1	
	1x Pg29	HC-STA-B10-HHWD-1TTP29-EL-AL	1412615	1	
		without bore hole HC-STA-B10-HHWD-BLANK-EL-AL	1420035	1	
Sleeve housing Height: 57 mm 	1x M20	Cable outlet: lateral HC-STA-B10-HLWD-1STM20-EL-AL	1412633	1	
	1x M25	HC-STA-B10-HLWD-1STM25-EL-AL	1412634	1	
	1x Pg16	HC-STA-B10-HLWD-1STP16-EL-AL	1412635	1	
	1x Pg21	HC-STA-B10-HLWD-1STP21-EL-AL	1412636	1	
		without bore hole HC-STA-B10-HLWD-BLANK-EL-AL	1420034	1	
Sleeve housing Height: 72 mm 	1x M25	Cable outlet: lateral HC-STA-B10-HHWD-1STM25-EL-AL	1412608	1	
	1x M32	HC-STA-B10-HHWD-1STM32-EL-AL	1412609	1	
	1x Pg21	HC-STA-B10-HHWD-1STP21-EL-AL	1412610	1	
	1x Pg29	HC-STA-B10-HHWD-1STP29-EL-AL	1412611	1	
		without bore hole HC-STA-B10-HHWD-BLANK-EL-AL	1420035	1	

Notes:

For further accessories, see from page 658
 Marking label: US-EMLP-HA (20X9), Order No. 0830989

Accessories



Cable glands
From page 686



Replacement latches
phoenixcontact.net/products





Protective covers
From page 654

Size B10, metal, supporting base elements for double locking latch



General data	
Housing material	Die-cast aluminum, salt water resistant
Locking latch material	PA
Sealing material	NBR, conductive
IP degree of protection (when plugged in)	IP66 / IP67
NEMA degree of protection (when plugged in)	4 / 4X / 12
Ambient temperature (operation)	-40°C ... 125°C

Technical data	
Housing material	Die-cast aluminum, salt water resistant
Locking latch material	PA
Sealing material	NBR, conductive
IP degree of protection (when plugged in)	IP66 / IP67
NEMA degree of protection (when plugged in)	4 / 4X / 12
Ambient temperature (operation)	-40°C ... 125°C

Description		Thread	Type	Order No.	Pcs./Pkt.
Panel mounting base Height: 30.5 mm 			With cover HC-STA-B10-BFDC-ELC-AL	1411323	1
Box mounting base¹⁾ Height: 54 mm 		2x M20 2x M25 2x Pg16	With cover HC-STA-B10-SLFDC-2SSM20-ELC-AL HC-STA-B10-SLFDC-2SSM25-ELC-AL HC-STA-B10-SLFDC-2SSP16-ELC-AL	1412830 1412831 1412832	1 1 1

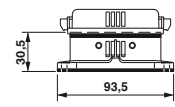
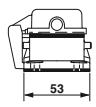
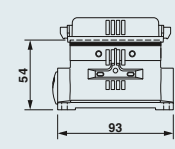
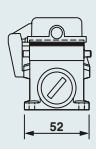
Dimensions	
	
	

Notes:
For further accessories, see from page 658
¹⁾ Supplied with a plastic sealing cap

Accessories

 Cable glands From page 686	 Replacement seals phoenixcontact.net/products	 Replacement protective covers phoenixcontact.net/products	 Cover plates From page 664
---	---	---	---

Heavy-duty connectors

HEAVYCON B – housings

Size B16, plastic, ADVANCE PL sleeve housings with cable gland

General data







Housing material	PA
Lock material	Stainless steel
Sealing material	NBR
IP degree of protection (when plugged in)	IP66 / IP67
NEMA degree of protection (when plugged in)	12
Ambient temperature (operation)	-40°C ... 100°C

Technical data

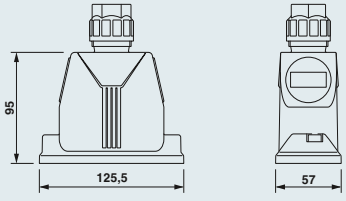
PA
Stainless steel
NBR
IP66 / IP67
12
-40°C ... 100°C

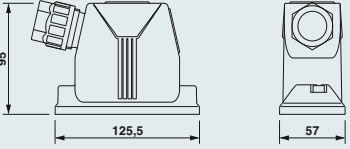

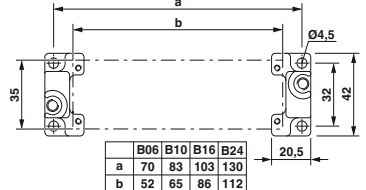
Ordering data

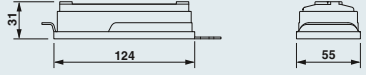
Description	Clamping area	Type	Order No.	Pcs./Pkt.	Dimensions															
Sleeve housing¹⁾ Height: 95 mm 	11 mm ... 21 mm 19 mm ... 28 mm	Cable outlet: top HC-ADV-B16-HHWH-1TGM32-PL HC-ADV-B16-HHWH-1TGM40-PL	1404231 1404233	1 1																
Sleeve housing¹⁾ Height: 95 mm 	11 mm ... 21 mm 19 mm ... 28 mm	Cable outlet: lateral HC-ADV-B16-HHWH-1SGM32-PL HC-ADV-B16-HHWH-1SGM40-PL	1404232 1404234	1 1																
Panel mounting flange 		2 pcs. per housing HC-B-AF Set with 2 panel mounting flanges HC-B-AF-SET	1686533 1604638	20 1	 <table border="1" data-bbox="1204 1533 1356 1585"> <thead> <tr> <th></th> <th>B06</th> <th>B10</th> <th>B16</th> <th>B24</th> </tr> </thead> <tbody> <tr> <td>a</td> <td>70</td> <td>83</td> <td>103</td> <td>130</td> </tr> <tr> <td>b</td> <td>52</td> <td>65</td> <td>86</td> <td>112</td> </tr> </tbody> </table>		B06	B10	B16	B24	a	70	83	103	130	b	52	65	86	112
	B06	B10	B16	B24																
a	70	83	103	130																
b	52	65	86	112																
Protective cover Height: 31.2 mm 		for sleeve side, IP50 HC-B 16-TMS-SD-IP50 for panel mounting side, IP66 HC-B 16-TMS-SD-IP66	1690752 1411517	10 10																

Notes:

Marking label: US-EMP (20X9) Order No. [0829439](#)

¹⁾ Screw locking with M6 Allen screws

Accessories



Allen keys
see Catalog 3



Replacement seals
phoenixcontact.net/products



Corrugated pipe adapters
see Catalog 3

Size B16, metal, ADVANCE sleeve housings



General data	
Housing material	Die-cast aluminum, salt water resistant
Surface material	Uncoated / powder coated, black
Lock material	Stainless steel
Sealing material	NBR, conductive / Viton
IP degree of protection (when plugged in)	IP66 / IP68 / IP69K
NEMA degree of protection (when plugged in)	4 / 4X / 12
Ambient temperature (operation)	-40°C ... 125°C

Technical data

Die-cast aluminum, salt water resistant
 Uncoated / powder coated, black
 Stainless steel
 NBR, conductive / Viton
 IP66 / IP68 / IP69K
 4 / 4X / 12
 -40°C ... 125°C

Ordering data

Description	Thread	Type	Order No.	Pcs./Pkt.	Dimensions															
Sleeve housing¹⁾ Height: 74 mm 	1x M25	Uncoated, EMC ready HC-ADV-B16-HLWH-1TTM25-EMC-AL	1414975	1																
		Uncoated, EMC ready, without drill hole HC-ADV-B16-HLWH-BLANK-ELC-AL	1420053	1																
	1x M25	Powder-coated, black HC-ADV-B16-HLWH-1TTM25-MF-BK	1420921	1																
Sleeve housing¹⁾ Height: 93.7 mm 	1x M25	Uncoated, EMC ready HC-ADV-B16-HHWH-1TTM25-EMC-AL	1414977	1																
	1x M32	Uncoated, EMC ready, without drill hole HC-ADV-B16-HHWH-1TTM32-EMC-AL	1413416	1																
	1x M40	Uncoated, EMC ready, without drill hole HC-ADV-B16-HHWH-1TTM40-EMC-AL	1413418	1																
		Uncoated, EMC ready, without drill hole HC-ADV-B16-HHWH-BLANK-ELC-AL	1420054	1																
	1x M25	Powder-coated, black HC-ADV-B16-HHWH-1TTM25-MF-BK	1420917	1																
	1x M32	HC-ADV-B16-HHWH-1TTM32-MF-BK	1420918	1																
1x M40	HC-ADV-B16-HHWH-1TTM40-MF-BK	1420919	1																	
Sleeve housing¹⁾ Height: 74 mm 	1x M25	Uncoated, EMC ready HC-ADV-B16-HLWH-1STM25-EMC-AL	1414976	1																
		Uncoated, EMC ready, without drill hole HC-ADV-B16-HLWH-BLANK-ELC-AL	1420053	1																
	1x M25	Powder-coated, black HC-ADV-B16-HLWH-1STM25-MF-BK	1420920	1																
Sleeve housing¹⁾ Height: 93.7 mm 	1x M25	Uncoated, EMC ready HC-ADV-B16-HHWH-1STM25-EMC-AL	1414978	1																
	1x M32	Uncoated, EMC ready, without drill hole HC-ADV-B16-HHWH-1STM32-EMC-AL	1413417	1																
	1x M40	Uncoated, EMC ready, without drill hole HC-ADV-B16-HHWH-1STM40-EMC-AL	1413419	1																
		Uncoated, EMC ready, without drill hole HC-ADV-B16-HHWH-BLANK-ELC-AL	1420054	1																
	1x M25	Powder-coated, black HC-ADV-B16-HHWH-1STM25-MF-BK	1420914	1																
	1x M32	HC-ADV-B16-HHWH-1STM32-MF-BK	1420915	1																
1x M40	HC-ADV-B16-HHWH-1STM40-MF-BK	1420916	1																	
Panel mounting flange 		2 pcs. per housing HC-B-AF Set with 2 panel mounting flanges HC-B-AF-SET	1686533 1604638	20 1	<table border="1"> <tr> <td></td> <td>B06</td> <td>B10</td> <td>B16</td> <td>B24</td> </tr> <tr> <td>a</td> <td>70</td> <td>83</td> <td>103</td> <td>130</td> </tr> <tr> <td>b</td> <td>52</td> <td>65</td> <td>86</td> <td>112</td> </tr> </table>		B06	B10	B16	B24	a	70	83	103	130	b	52	65	86	112
	B06	B10	B16	B24																
a	70	83	103	130																
b	52	65	86	112																
Protective cover Height: 31.2 mm 		for sleeve side, IP50 HC-B 16-TMS-SD-IP50	1690752	10																
		for panel mounting side, IP66 HC-B 16-TMS-SD-IP66	1411517	10																

Notes:
In order to achieve optimum shielding results, the mounting surface must be conductive
Marking label: US-EMLP-HA (20X9), Order No. 0830989
¹⁾ Screw locking with M6 Allen screws

Accessories



Cable glands
From page 686



Allen keys
see Catalog 3



Replacement seals
phoenixcontact.net/products

Heavy-duty connectors

HEAVYCON B – housings

Size B16, plastic, EVO housings, single locking latch











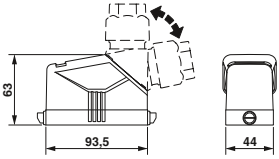

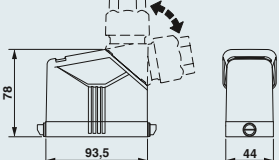
General data

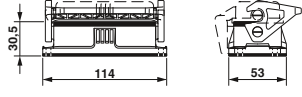
Housing material	PA
Locking latch material	PA
Sealing material	NBR
IP degree of protection (when plugged in)	IP66
NEMA degree of protection (when plugged in)	12
Ambient temperature (operation)	-40°C ... 125°C

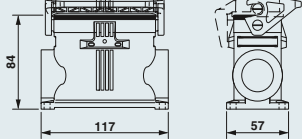
Technical data

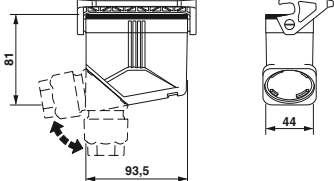
Ordering data

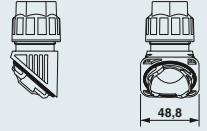
Description	Thread	Type	Order No.	Pcs./Pkt.	Dimensions
Sleeve housing Height: 63 mm 		HC-EVO-B16-HLFS-PLBK	1420931	1	
Sleeve housing Height: 78 mm 		HC-EVO-B16-HHFS-PLBK	1407642	1	
Panel mounting base Height: 30.5 mm 		Without cover HC-EVO-B16-BWS-PLRBK	1407646	1	
		With cover HC-EVO-B16-BWSC-PLRBK	1407647	1	
Box mounting base¹⁾ Height: 84 mm 	2x M25	Without cover HC-EVO-B16-SHWS-2SSM25-PLRBK	1421381	1	
	2x M32	HC-EVO-B16-SHWS-2SSM32-PLRBK	1421363	1	
	2x M40	HC-EVO-B16-SHWS-2SSM40-PLRBK	1407650	1	
	2x M25	With cover HC-EVO-B16-SHWSC-2SSM25-PLRBK	1421382	1	
	2x M32	HC-EVO-B16-SHWSC-2SSM32-PLRBK	1421364	1	
2x M40	HC-EVO-B16-SHWSC-2SSM40-PLRBK	1407651	1		
Coupling housing Height: 81 mm 		HC-EVO-B16-CHWS-PLRBK	1407654	1	
Cable gland 	Clamping area	HC-B-G-M20-PLRBK	1407669	1	
	7 mm ... 13 mm	HC-B-G-M25-PLRBK	1407670	1	
	9 mm ... 17 mm	HC-B-G-M32-PLRBK	1407671	1	
	11 mm ... 21 mm	HC-B-G-M40-PLRBK	1407672	1	
	19 mm ... 28 mm				

Notes:

For further accessories, see from page 658

Marking label: US-EMP (20X9) Order No. 0829439

¹⁾ One cable entry is sealed with a knockout cover

Accessories



EVO unlocking tools
From page 659



Thread adapters
From page 659



Replacement seals
phoenixcontact.net/products



Connector sets
From page 646

Size B16, metal, EVO housings, single locking latch



General data	
Housing material	Die-cast aluminum, salt water resistant
Locking latch material	PA
Sealing material	NBR, conductive
IP degree of protection (when plugged in)	IP66 / IP67
NEMA degree of protection (when plugged in)	4 / 4X / 12
Ambient temperature (operation)	-40°C ... 125°C

Technical data	
Housing material	Die-cast aluminum, salt water resistant
Locking latch material	PA
Sealing material	NBR, conductive
IP degree of protection (when plugged in)	IP66 / IP67
NEMA degree of protection (when plugged in)	4 / 4X / 12
Ambient temperature (operation)	-40°C ... 125°C

Description		Thread	Type	Order No.	Pcs./Pkt.	Dimensions
Sleeve housing Height: 88 mm			HC-EVO-B16-HHFS-EL-AL	1411461	1	
Panel mounting base Height: 30.5 mm			Without cover HC-STA-B16-BWS-ELC-AL With cover HC-STA-B16-BWSC-ELC-AL	1411324 1411325	1 1	
Box mounting base ¹⁾ Height: 68 mm		2x M25 2x M32 2x Pg21	Without cover HC-STA-B16-SLWS-2SSM25-ELC-AL HC-STA-B16-SLWS-2SSM32-ELC-AL HC-STA-B16-SLWS-2SSP21-ELC-AL With cover HC-STA-B16-SLWSC-2SSM25-ELC-AL HC-STA-B16-SLWSC-2SSM32-ELC-AL HC-STA-B16-SLWSC-2SSP21-ELC-AL	1412861 1412862 1412863 1412865 1412866 1412867	1 1 1 1 1 1	
Box mounting base ¹⁾ Height: 84.7 mm		2x M25 2x M32 2x M40 2x M25 2x M32 2x M40	Without cover HC-STA-B16-SHWS-2SSM25-ELC-AL HC-STA-B16-SHWS-2SSM32-ELC-AL HC-STA-B16-SHWS-2SSM40-ELC-AL With cover HC-STA-B16-SHWSC-2SSM25-ELC-AL HC-STA-B16-SHWSC-2SSM32-ELC-AL HC-STA-B16-SHWSC-2SSM40-ELC-AL	1082586 1082587 1082588 1082589 1082590 1082591	1 1 1 1 1 1	
Coupling housing Height: 79 mm		1x M25 1x M32 1x Pg21 1x Pg29	Cable outlet: top HC-STA-B16-CHWS-1TTM25-ELC-AL HC-STA-B16-CHWS-1TTM32-ELC-AL HC-STA-B16-CHWS-1TTP21-ELC-AL HC-STA-B16-CHWS-1TTP29-ELC-AL	1412645 1412646 1412647 1412648	1 1 1 1	
Cable gland		Clamping area 9 mm ... 13 mm 11 mm ... 16 mm 14 mm ... 21 mm 19 mm ... 27 mm	HC-B-G-M20-EC-AL HC-B-G-M25-EC-AL HC-B-G-M32-EC-AL HC-B-G-M40-EC-AL	1411439 1411446 1411440 1411441	1 1 1 1	

Notes:
For further accessories, see from page 658
Marking label: US-EMLP-HA (20X9), Order No. 0830989
¹⁾ Supplied with a plastic sealing cap

Ordering data		
Type	Order No.	Pcs./Pkt.

Accessories

EMC cable glands From page 660	Cable glands From page 686	Replacement seals phoenixcontact.net/products	Connector sets phoenixcontact.net/products

Heavy-duty connectors

HEAVYCON B – housings

Size B16, metal, sleeve housings for single locking latch







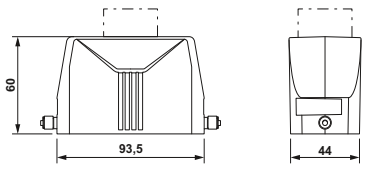

General data

Housing material
Locking latch material
Sealing material
IP degree of protection (when plugged in)
NEMA degree of protection (when plugged in)
Ambient temperature (operation)

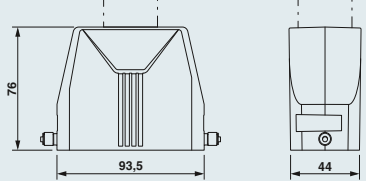
Technical data	
Housing material	Die-cast aluminum, salt water resistant
Locking latch material	-
Sealing material	-
IP degree of protection (when plugged in)	IP66 / IP67
NEMA degree of protection (when plugged in)	4 / 4X / 12
Ambient temperature (operation)	-40°C ... 125°C

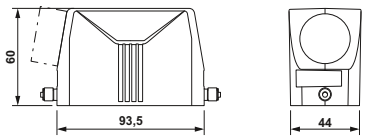
Ordering data

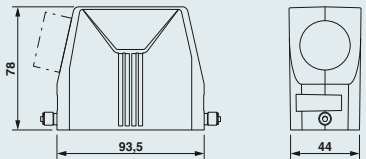
Description	Thread	Type	Order No.	Pcs./Pkt.	Dimensions
Sleeve housing Height: 60 mm 	1x M25 1x M32 1x Pg16 1x Pg21	Cable outlet: top			
		HC-STA-B16-HLFS-1TTM25-EL-AL	1412729	1	
		HC-STA-B16-HLFS-1TTM32-EL-AL	1412730	1	
		HC-STA-B16-HLFS-1TTP16-EL-AL	1412731	1	
		HC-STA-B16-HLFS-1TTP21-EL-AL	1412732	1	
		without bore hole			
HC-STA-B16-HLFS-BLANK-EL-AL	1419905	1			
Sleeve housing Height: 76 mm 	1x M32 1x M40 1x Pg21 1x Pg29	Cable outlet: top			
		HC-STA-B16-HHFS-1TTM32-EL-AL	1412689	1	
		HC-STA-B16-HHFS-1TTM40-EL-AL	1412700	1	
		HC-STA-B16-HHFS-1TTP21-EL-AL	1412701	1	
		HC-STA-B16-HHFS-1TTP29-EL-AL	1412702	1	
		without bore hole			
HC-STA-B16-HHFS-BLANK-EL-AL	1419934	1			
Sleeve housing Height: 60 mm 	1x M25 1x M32 1x Pg16 1x Pg21	Cable outlet: lateral			
		HC-STA-B16-HLFS-1STM25-EL-AL	1412725	1	
		HC-STA-B16-HLFS-1STM32-EL-AL	1412726	1	
		HC-STA-B16-HLFS-1STP16-EL-AL	1412727	1	
		HC-STA-B16-HLFS-1STP21-EL-AL	1412728	1	
		without bore hole			
HC-STA-B16-HLFS-BLANK-EL-AL	1419905	1			
Sleeve housing Height: 76 mm 	1x M32 1x M40 1x Pg21 1x Pg29	Cable outlet: lateral			
		HC-STA-B16-HHFS-1STM32-EL-AL	1412679	1	
		HC-STA-B16-HHFS-1STM40-EL-AL	1412682	1	
		HC-STA-B16-HHFS-1STP21-EL-AL	1412683	1	
		HC-STA-B16-HHFS-1STP29-EL-AL	1412684	1	
		without bore hole			
HC-STA-B16-HHFS-BLANK-EL-AL	1419934	1			

Notes:
 For further accessories, see from page 658
 Marking label: US-EMLP-HA (20X9), Order No. 0830989

Accessories

 Cable glands From page 686	 Protective covers From page 654	 Cover plates From page 664	 Connector sets From page 647
---	--	---	---

Size B16, metal, supporting base elements with single locking latch



General data		Technical data	
Housing material		Die-cast aluminum, salt water resistant	
Locking latch material		PA	
Sealing material		NBR, conductive	
IP degree of protection (when plugged in)		IP66 / IP67	
NEMA degree of protection (when plugged in)		4 / 4X / 12	
Ambient temperature (operation)		-40°C ... 125°C	

Description		Thread	Type	Order No.	Pcs./Pkt.	Dimensions
Panel mounting base Height: 30.5 mm			Without cover HC-STA-B16-BWS-ELC-AL	1411324	1	
			With cover HC-STA-B16-BWSC-ELC-AL	1411325	1	
Box mounting base¹⁾ Height: 68 mm		2x M25 2x M32 2x Pg21	Without cover HC-STA-B16-SLWS-2SSM25-ELC-AL HC-STA-B16-SLWS-2SSM32-ELC-AL HC-STA-B16-SLWS-2SSP21-ELC-AL	1412861 1412862 1412863	1 1 1	
			With cover HC-STA-B16-SLWSC-2SSM25-ELC-AL HC-STA-B16-SLWSC-2SSM32-ELC-AL HC-STA-B16-SLWSC-2SSP21-ELC-AL	1412865 1412866 1412867	1 1 1	
Box mounting base¹⁾ Height: 84.7 mm		2x M25 2x M32 2x M40	Without cover HC-STA-B16-SHWS-2SSM25-ELC-AL HC-STA-B16-SHWS-2SSM32-ELC-AL HC-STA-B16-SHWS-2SSM40-ELC-AL	1082586 1082587 1082588	1 1 1	
			With cover HC-STA-B16-SHWSC-2SSM25-ELC-AL HC-STA-B16-SHWSC-2SSM32-ELC-AL HC-STA-B16-SHWSC-2SSM40-ELC-AL	1082589 1082590 1082591	1 1 1	
Coupling housing Height: 79 mm		1x M25 1x M32 1x Pg21 1x Pg29	Cable outlet: top HC-STA-B16-CHWS-1TTM25-ELC-AL HC-STA-B16-CHWS-1TTM32-ELC-AL HC-STA-B16-CHWS-1TTP21-ELC-AL HC-STA-B16-CHWS-1TTP29-ELC-AL	1412645 1412646 1412647 1412648	1 1 1 1	

Notes:
For further accessories, see from page 658
¹⁾ Supplied with a plastic sealing cap

Accessories

<p>Cable glands From page 686</p>	<p>Replacement seals phoenixcontact.net/products</p>	<p>Replacement protective covers phoenixcontact.net/products</p>	<p>Replacement latches phoenixcontact.net/products</p>
--	--	--	--

Heavy-duty connectors

HEAVYCON B – housings

Size B16, plastic, EVO housings, double locking latch











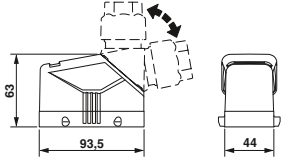

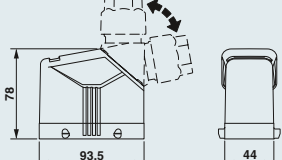
General data

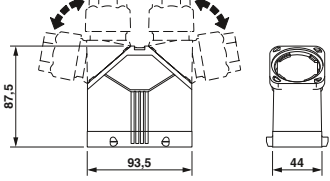
Housing material	PA
Locking latch material	PA
Sealing material	NBR
IP degree of protection (when plugged in)	IP66
NEMA degree of protection (when plugged in)	12
Ambient temperature (operation)	-40°C ... 125°C

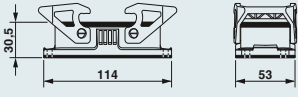
Technical data

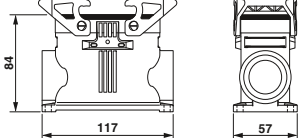
Ordering data

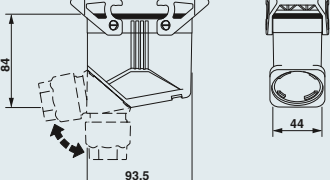
Description	Thread	Type	Order No.	Pcs./Pkt.	Dimensions
Sleeve housing Height: 63 mm 		HC-EVO-B16-HLFD-PLBK	1420932	1	
Sleeve housing Height: 78 mm 		HC-EVO-B16-HHFD-PLBK	1407643	1	
Double sleeve housing Height: 78 mm 		for double locking latch HC-EVO-B16-HHFD-2B-PL-BK	1411496	1	
Panel mounting base Height: 30.5 mm 		Without cover HC-EVO-B16-BWD-PLRBK	1407648	1	
Box mounting base¹⁾ Height: 84 mm 	2x M25 2x M32 2x M40	Without cover HC-EVO-B16-SHWD-2SSM25-PLRBK HC-EVO-B16-SHWD-2SSM32-PLRBK HC-EVO-B16-SHWD-2SSM40-PLRBK	1421455 1421365 1407652	1 1 1	
Coupling housing Height: 84 mm 		HC-EVO-B16-CHWD-PLRBK	1407655	1	

Notes:

For further accessories, see from page 658

Marking label: US-EMP (20X9) Order No. 0829439

¹⁾ One cable entry is sealed with a knockout cover

Accessories



Cable glands
From page 658



Thread adapters
From page 659



Replacement seals
phoenixcontact.net/products



Connector sets
From page 646

Size B16, metal, EVO housings, double locking latch









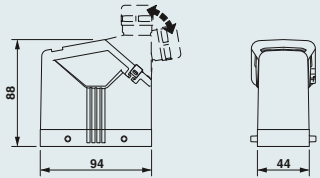

Technical data

General data

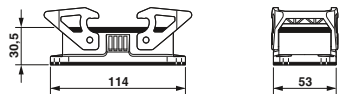
Housing material
Locking latch material
Sealing material
IP degree of protection (when plugged in)
NEMA degree of protection (when plugged in)
Ambient temperature (operation)

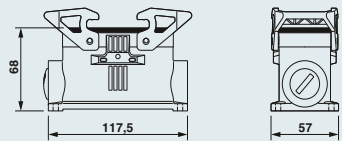
Die-cast aluminum, salt water resistant
Polyamide
NBR, conductive
IP66 / IP67
4 / 4X / 12
-40°C ... 125°C

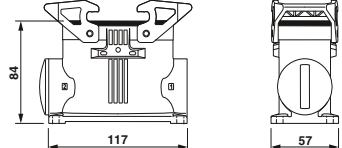
Ordering data

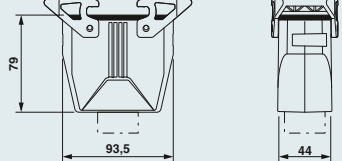
Description	Thread	Type	Order No.	Pcs./Pkt.	Dimensions
Sleeve housing Height: 88 mm 		HC-EVO-B16-HHFD-EL-AL	1411460	1	
Panel mounting base Height: 30.5 mm 		Without cover HC-STA-B16-BWD-ELC-AL	1411327	1	
Box mounting base¹⁾ Height: 68 mm 	2x M25 2x M32 2x Pg21	Without cover HC-STA-B16-SLWD-2SSM25-ELC-AL HC-STA-B16-SLWD-2SSM32-ELC-AL HC-STA-B16-SLWD-2SSP21-ELC-AL	1412855 1412856 1412857	1 1 1	
Box mounting base¹⁾ Height: 84.7 mm 	2x M25 2x M32 2x M40	Without cover HC-STA-B16-SHWD-2SSM25-ELC-AL HC-STA-B16-SHWD-2SSM32-ELC-AL HC-STA-B16-SHWD-2SSM40-ELC-AL	1082600 1082601 1082602	1 1 1	
Coupling housing Height: 79 mm 	1x M25 1x M32 1x Pg21 1x Pg29	Cable outlet: top HC-STA-B16-CHWD-1TTM25-ELC-AL HC-STA-B16-CHWD-1TTM32-ELC-AL HC-STA-B16-CHWD-1TTP21-ELC-AL HC-STA-B16-CHWD-1TTP29-ELC-AL	1412641 1412642 1412643 1412644	1 1 1 1	

Notes:

For further accessories, see from page 658

Marking label: US-EMLP-HA (20X9), Order No. 0830989

¹⁾ Supplied with a plastic sealing cap

Accessories



Cable glands
From page 660



Cable glands
From page 686



Replacement seals
phoenixcontact.net/products



Connector sets
phoenixcontact.net/products

Heavy-duty connectors

HEAVYCON B – housings

Size B16, metal, sleeve housings for double locking latch

new











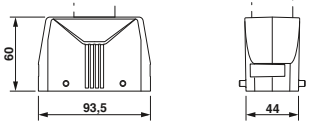

General data

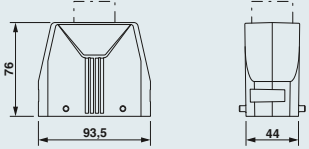
Housing material	Die-cast aluminum, salt water resistant
Locking latch material	-
Sealing material	-
IP degree of protection (when plugged in)	IP66 / IP67
NEMA degree of protection (when plugged in)	4 / 4X / 12
Ambient temperature (operation)	-40°C ... 125°C

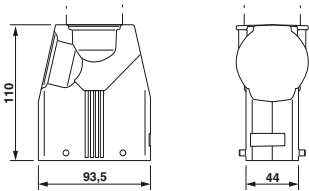
Technical data

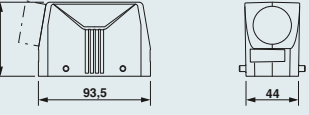
Housing material	Die-cast aluminum, salt water resistant
Locking latch material	-
Sealing material	-
IP degree of protection (when plugged in)	IP66 / IP67
NEMA degree of protection (when plugged in)	4 / 4X / 12
Ambient temperature (operation)	-40°C ... 125°C

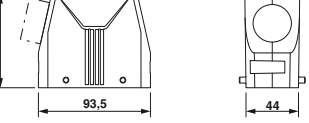
Ordering data

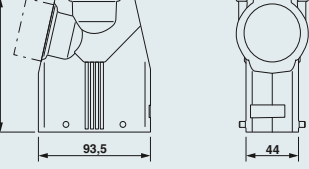
Description	Thread	Type	Order No.	Pcs./Pkt.	Dimensions	
Sleeve housing Height: 60 mm 	1x M25	Cable outlet: top HC-STA-B16-HLFD-1TTM25-EL-AL	1412721	1		
	1x M32	HC-STA-B16-HLFD-1TTM32-EL-AL	1412722	1		
	1x Pg16	HC-STA-B16-HLFD-1TTP16-EL-AL	1412723	1		
	1x Pg21	HC-STA-B16-HLFD-1TTP21-EL-AL	1412724	1		
		without bore hole				
			HC-STA-B16-HLFD-BLANK-EL-AL	1419999		1
Sleeve housing Height: 76 mm 	1x M32	Cable outlet: top HC-STA-B16-HHFD-1TTM32-EL-AL	1412653	1		
	1x M40	HC-STA-B16-HHFD-1TTM40-EL-AL	1412654	1		
	1x Pg21	HC-STA-B16-HHFD-1TTP21-EL-AL	1412669	1		
	1x Pg29	HC-STA-B16-HHFD-1TTP29-EL-AL	1412678	1		
		without bore hole				
			HC-STA-B16-HHFD-BLANK-EL-AL	1420000		1
Sleeve housing Height: 110.8 mm 	1x M50	Cable outlet: top HC-STA-B16-HHFD-1TTM50-EL-AL	1082552	1		
Sleeve housing Height: 60 mm 	1x M25	Cable outlet: lateral HC-STA-B16-HLFD-1STM25-EL-AL	1412717	1		
	1x M32	HC-STA-B16-HLFD-1STM32-EL-AL	1412718	1		
	1x Pg16	HC-STA-B16-HLFD-1STP16-EL-AL	1412719	1		
	1x Pg21	HC-STA-B16-HLFD-1STP21-EL-AL	1412720	1		
		without bore hole				
			HC-STA-B16-HLFD-BLANK-EL-AL	1419999		1
Sleeve housing Height: 76 mm 	1x M32	Cable outlet: lateral HC-STA-B16-HHFD-1STM32-EL-AL	1412649	1		
	1x M40	HC-STA-B16-HHFD-1STM40-EL-AL	1412650	1		
	1x Pg21	HC-STA-B16-HHFD-1STP21-EL-AL	1412651	1		
	1x Pg29	HC-STA-B16-HHFD-1STP29-EL-AL	1412652	1		
		without bore hole				
			HC-STA-B16-HHFD-BLANK-EL-AL	1420000		1
Sleeve housing Height: 110.8 mm 	1x M50	Cable outlet: lateral HC-STA-B16-HHFD-1STM50-EL-AL	1082551	1		

Notes:

For further accessories, see from page 658

Marking label: US-EMLP-HA (20X9), Order No. 0830989

Accessories



Cable glands
From page 686



Protective covers
From page 654



Cover plates
From page 664



Connector sets
From page 647







Size B16, metal, supporting base elements with double locking latch

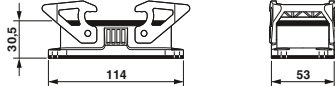

Technical data

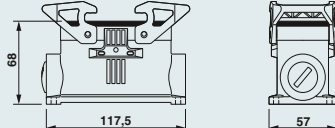
General data	
Housing material	Die-cast aluminum, salt water resistant
Locking latch material	PA
Sealing material	NBR, conductive
IP degree of protection (when plugged in)	IP66 / IP67
NEMA degree of protection (when plugged in)	4 / 4X / 12
Ambient temperature (operation)	-40°C ... 125°C

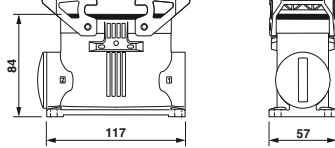
Ordering data

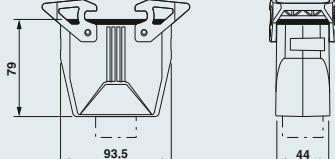
Description	Thread	Type	Order No.	Pcs./Pkt.	Dimensions
Panel mounting base Height: 30.5 mm 		Without cover HC-STA-B16-BWD-ELC-AL	1411327	1	
Box mounting base¹⁾ Height: 68 mm 	2x M25 2x M32 2x Pg21	Without cover HC-STA-B16-SLWD-2SSM25-ELC-AL HC-STA-B16-SLWD-2SSM32-ELC-AL HC-STA-B16-SLWD-2SSP21-ELC-AL	1412855 1412856 1412857	1 1 1	
Box mounting base¹⁾ Height: 84.7 mm 	2x M25 2x M32 2x M40	Without cover HC-STA-B16-SHWD-2SSM25-ELC-AL HC-STA-B16-SHWD-2SSM32-ELC-AL HC-STA-B16-SHWD-2SSM40-ELC-AL	1082600 1082601 1082602	1 1 1	
Coupling housing Height: 79 mm 	1x M25 1x M32 1x Pg21 1x Pg29	Cable outlet: top HC-STA-B16-CHWD-1TTM25-ELC-AL HC-STA-B16-CHWD-1TTM32-ELC-AL HC-STA-B16-CHWD-1TTP21-ELC-AL HC-STA-B16-CHWD-1TTP29-ELC-AL	1412641 1412642 1412643 1412644	1 1 1 1	

Notes:

For further accessories, see from page 658

¹⁾ Supplied with a plastic sealing cap

Accessories



Cable glands
From page 686



Replacement seals
phoenixcontact.net/products



Replacement protective covers
phoenixcontact.net/products



Replacement latches
phoenixcontact.net/products

Heavy-duty connectors

HEAVYCON B – housings

Size B16, plastic, EVO housings, double locking latch









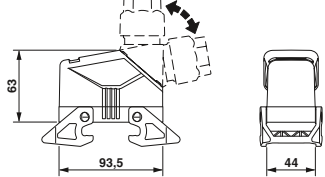

General data

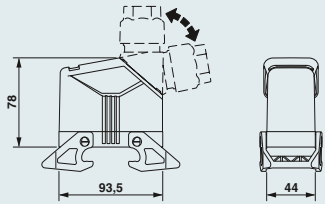
Housing material	PA
Locking latch material	PA
Sealing material	NBR
IP degree of protection (when plugged in)	IP66
NEMA degree of protection (when plugged in)	12
Ambient temperature (operation)	-40°C ... 125°C

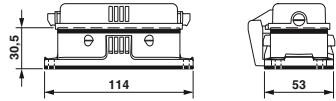
Technical data

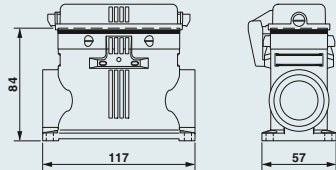
Ordering data

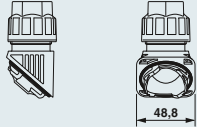
Description	Thread	Type	Order No.	Pcs./Pkt.	Dimensions
Sleeve housing Height: 63 mm 		HC-EVO-B16-HLWD-PLBK	1420933	1	
Sleeve housing Height: 78 mm 		HC-EVO-B16-HHWD-PLBK	1407644	1	
Panel mounting base Height: 30.5 mm 		With cover HC-EVO-B16-BFDC-PLRBK	1407649	1	
Box mounting base¹⁾ Height: 84 mm 	2x M25 2x M32 2x M40	With cover HC-EVO-B16-SHFDC-2SSM25-PLRBK HC-EVO-B16-SHFDC-2SSM32-PLRBK HC-EVO-B16-SHFDC-2SSM40-PLRBK	1421458 1421366 1407653	1 1 1	
Cable gland 	Clamping area 7 mm ... 13 mm 9 mm ... 17 mm 11 mm ... 21 mm 19 mm ... 28 mm	HC-B-G-M20-PLRBK HC-B-G-M25-PLRBK HC-B-G-M32-PLRBK HC-B-G-M40-PLRBK	1407669 1407670 1407671 1407672	1 1 1 1	

Notes:

For further accessories, see from page 658

Marking label: US-EMP (20X9) Order No. 0829439

¹⁾ One cable entry is sealed with a knockout cover

Accessories



EVO unlocking tools
From page 659



Thread adapters
From page 659



Replacement seals
phoenixcontact.net/products



Replacement latches
phoenixcontact.net/products







Size B16, metal, EVO housings, double locking latch

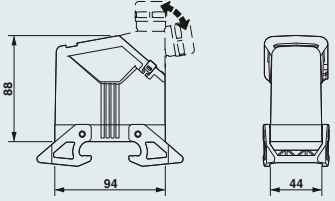

Technical data

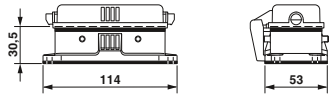
General data	
Housing material	Die-cast aluminum, salt water resistant
Locking latch material	PA
Sealing material	NBR, conductive
IP degree of protection (when plugged in)	IP66 / IP67
NEMA degree of protection (when plugged in)	4 / 4X / 12
Ambient temperature (operation)	-40°C ... 125°C

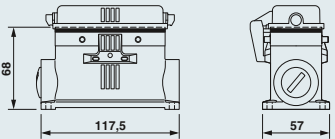
Ordering data

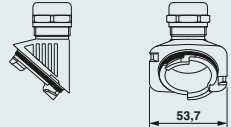
Description	Thread	Type	Order No.	Pcs./Pkt.	Dimensions
Sleeve housing Height: 88 mm 		HC-EVO-B16-HHWD-EL-AL	1411462	1	
Panel mounting base Height: 30.5 mm 		With cover HC-STA-B16-BFDC-ELC-AL	1411328	1	
Box mounting base¹⁾ Height: 68 mm 	2x M25 2x M32 2x Pg16 2x Pg21	With cover HC-STA-B16-SLFDC-2SSM25-ELC-AL HC-STA-B16-SLFDC-2SSM32-ELC-AL HC-STA-B16-SLFDC-2SSP16-ELC-AL HC-STA-B16-SLFDC-2SSP21-ELC-AL	1412849 1412850 1412852 1412853	1 1 1 1	
Cable gland 	Clamping area 9 mm ... 13 mm 11 mm ... 16 mm 14 mm ... 21 mm 19 mm ... 27 mm	HC-B-G-M20-EC-AL HC-B-G-M25-EC-AL HC-B-G-M32-EC-AL HC-B-G-M40-EC-AL	1411439 1411446 1411440 1411441	1 1 1 1	

Notes:

For further accessories, see from page 658

Marking label: US-EMLP-HA (20X9), Order No. 0830989

¹⁾ Supplied with a plastic sealing cap

Accessories



Thread adapters
From page 660



EMC cable glands
From page 660



Replacement seals
phoenixcontact.net/products



Replacement latches
phoenixcontact.net/products

Heavy-duty connectors

HEAVYCON B – housings

Size B16, metal, sleeve housings with double locking latch







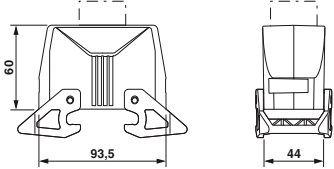

General data

Housing material
Locking latch material
Sealing material
IP degree of protection (when plugged in)
NEMA degree of protection (when plugged in)
Ambient temperature (operation)

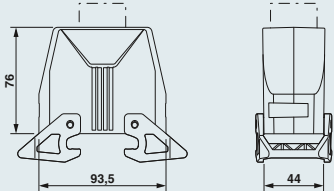
Technical data
Die-cast aluminum, salt water resistant
PA
-
IP66 / IP67
4 / 4X / 12
-40°C ... 125°C

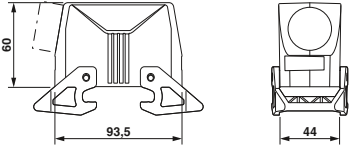
Ordering data

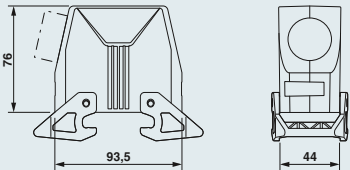
Description	Thread	Type	Order No.	Pcs./Pkt.	Dimensions
Sleeve housing Height: 60 mm 	1x M25 1x M32 1x Pg16 1x Pg21	Cable outlet: top			
		HC-STA-B16-HLWD-1TTM25-EL-AL	1412738	1	
		HC-STA-B16-HLWD-1TTM32-EL-AL	1412739	1	
		HC-STA-B16-HLWD-1TTP16-EL-AL	1412740	1	
		HC-STA-B16-HLWD-1TTP21-EL-AL	1412741	1	
		without bore hole			
HC-STA-B16-HLWD-BLANK-EL-AL	1420036	1			
Sleeve housing Height: 76 mm 	1x M32 1x M40 1x Pg21 1x Pg29	Cable outlet: top			
		HC-STA-B16-HHWD-1TTM32-EL-AL	1412708	1	
		HC-STA-B16-HHWD-1TTM40-EL-AL	1412709	1	
		HC-STA-B16-HHWD-1TTP21-EL-AL	1412715	1	
		HC-STA-B16-HHWD-1TTP29-EL-AL	1412716	1	
		without bore hole			
HC-STA-B16-HHWD-BLANK-EL-AL	1420044	1			
Sleeve housing Height: 60 mm 	1x M25 1x M32 1x Pg16 1x Pg21	Cable outlet: lateral			
		HC-STA-B16-HLWD-1STM25-EL-AL	1412733	1	
		HC-STA-B16-HLWD-1STM32-EL-AL	1412734	1	
		HC-STA-B16-HLWD-1STP16-EL-AL	1412735	1	
		HC-STA-B16-HLWD-1STP21-EL-AL	1412737	1	
		without bore hole			
HC-STA-B16-HLWD-BLANK-EL-AL	1420036	1			
Sleeve housing Height: 76 mm 	1x M32 1x M40 1x Pg21 1x Pg29	Cable outlet: lateral			
		HC-STA-B16-HHWD-1STM32-EL-AL	1412703	1	
		HC-STA-B16-HHWD-1STM40-EL-AL	1412704	1	
		HC-STA-B16-HHWD-1STP21-EL-AL	1412705	1	
		HC-STA-B16-HHWD-1STP29-EL-AL	1412706	1	
		without bore hole			
HC-STA-B16-HHWD-BLANK-EL-AL	1420044	1			

Notes:
For further accessories, see from page 658
Marking label: US-EMLP-HA (20X9), Order No. 0830989

Accessories



 Cable glands From page 686	 Protective covers From page 654	 Replacement latches phoenixcontact.net/products
---	--	---



Size B16, metal, supporting base elements for double locking latch





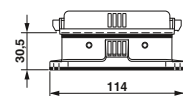

General data	
Housing material	Die-cast aluminum, salt water resistant
Locking latch material	PA
Sealing material	NBR, conductive
IP degree of protection (when plugged in)	IP66 / IP67
NEMA degree of protection (when plugged in)	4 / 4X / 12
Ambient temperature (operation)	-40°C ... 125°C

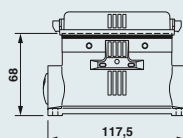
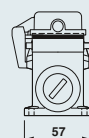
Technical data	
Housing material	Die-cast aluminum, salt water resistant
Locking latch material	PA
Sealing material	NBR, conductive
IP degree of protection (when plugged in)	IP66 / IP67
NEMA degree of protection (when plugged in)	4 / 4X / 12
Ambient temperature (operation)	-40°C ... 125°C

Description		Thread	Type	Order No.	Pcs./Pkt.
Panel mounting base Height: 30.5 mm 			With cover HC-STA-B16-BFDC-ELC-AL	1411328	1
Box mounting base¹⁾ Height: 68 mm 		2x M25 2x M32 2x Pg16 2x Pg21	With cover HC-STA-B16-SLFDC-2SSM25-ELC-AL HC-STA-B16-SLFDC-2SSM32-ELC-AL HC-STA-B16-SLFDC-2SSP16-ELC-AL HC-STA-B16-SLFDC-2SSP21-ELC-AL	1412849 1412850 1412852 1412853	1 1 1 1

Dimensions	
	
	

Notes:
For further accessories, see from page 658
¹⁾ Supplied with a plastic sealing cap

Accessories			
 <p>Cable glands From page 686</p>	 <p>Replacement seals phoenixcontact.net/products</p>	 <p>Replacement protective covers phoenixcontact.net/products</p>	 <p>Cover plates From page 664</p>

Heavy-duty connectors

HEAVYCON B – housings

Size B24, plastic, ADVANCE sleeve housings with cable gland







General data

Housing material	PA
Lock material	Stainless steel
Sealing material	NBR
IP degree of protection (when plugged in)	IP66 / IP67
NEMA degree of protection (when plugged in)	12
Ambient temperature (operation)	-40°C ... 100°C

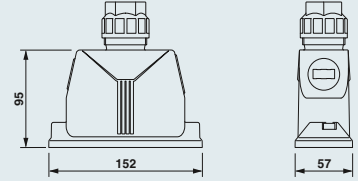
Technical data

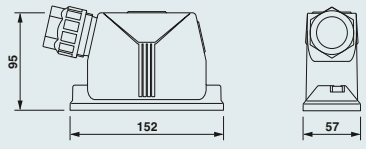

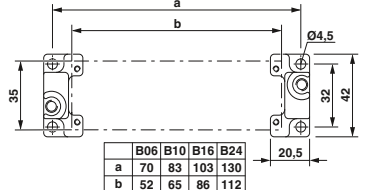
Ordering data

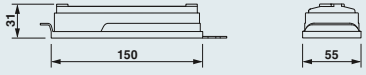
Description	Clamping area	Type	Order No.	Pcs./Pkt.	Dimensions															
Sleeve housing¹⁾ Height: 95 mm 	11 mm ... 21 mm 19 mm ... 28 mm	Cable outlet: top HC-ADV-B24-HHWH-1TGM32-PL HC-ADV-B24-HHWH-1TGM40-PL	1404235 1404238	1 1																
Sleeve housing¹⁾ Height: 95 mm 	11 mm ... 21 mm 19 mm ... 28 mm	Cable outlet: lateral HC-ADV-B24-HHWH-1SGM32-PL HC-ADV-B24-HHWH-1SGM40-PL	1404237 1404239	1 1																
Panel mounting flange 		2 pcs. per housing HC-B-AF Set with 2 panel mounting flanges HC-B-AF-SET	1686533 1604638	20 1	 <table border="1" data-bbox="1204 1533 1356 1585"> <thead> <tr> <th></th> <th>B06</th> <th>B10</th> <th>B16</th> <th>B24</th> </tr> </thead> <tbody> <tr> <td>a</td> <td>70</td> <td>83</td> <td>103</td> <td>130</td> </tr> <tr> <td>b</td> <td>52</td> <td>65</td> <td>86</td> <td>112</td> </tr> </tbody> </table>		B06	B10	B16	B24	a	70	83	103	130	b	52	65	86	112
	B06	B10	B16	B24																
a	70	83	103	130																
b	52	65	86	112																
Protective cover Height: 31.2 mm 		for sleeve side, IP50 HC-B 24-TMS-SD-IP50 for panel mounting side, IP66 HC-B 24-TMS-SD-IP66	1690765 1411520	10 10																

Notes:

Marking label: US-EMP (20X9) Order No. 0829439

¹⁾ Screw locking with M6 Allen screws

Accessories



Allen keys
see Catalog 3



Replacement seals
phoenixcontact.net/products



Corrugated pipe adapters
see Catalog 3

Size B24, metal, ADVANCE sleeve housings











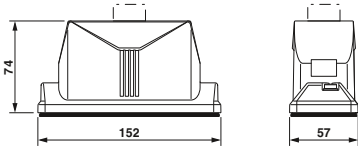

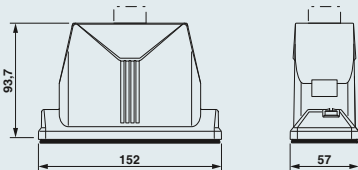
General data	
Housing material	Die-cast aluminum, salt water resistant
Surface material	Uncoated / powder coated, black
Lock material	Stainless steel
Sealing material	NBR, conductive / Viton
IP degree of protection (when plugged in)	IP66 / IP68 / IP69K
NEMA degree of protection (when plugged in)	4 / 4X / 12
Ambient temperature (operation)	-40°C ... 125°C

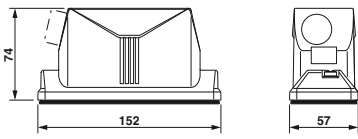
Technical data

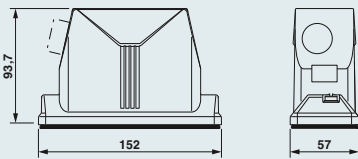
Die-cast aluminum, salt water resistant
Uncoated / powder coated, black
Stainless steel
NBR, conductive / Viton
IP66 / IP68 / IP69K
4 / 4X / 12
-40°C ... 125°C

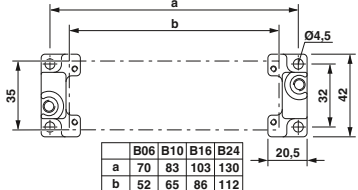
Ordering data

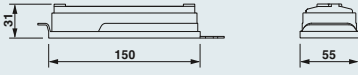
Description	Thread	Type	Order No.	Pcs./Pkt.	Dimensions															
Sleeve housing¹⁾ Height: 74 mm 	1x M25	Uncoated, EMC ready HC-ADV-B24-HLWH-1TTM25-EMC-AL	1414982	1																
	1x M25	Uncoated, EMC ready Height: 74 mm HC-ADV-B24-HLWH-BLANK-ELC-AL	1420055	1																
	1x M25	Powder-coated, black HC-ADV-B24-HLWH-1TTM25-MF-BK	1420929	1																
Sleeve housing¹⁾ Height: 93.7 mm 	1x M25	Uncoated, EMC ready HC-ADV-B24-HHWH-1TTM25-EMC-AL	1414980	1																
	1x M32	HC-ADV-B24-HHWH-1TTM32-EMC-AL	1413430	1																
	1x M40	HC-ADV-B24-HHWH-1TTM40-EMC-AL	1413432	1																
	1x M25	Uncoated, EMC ready, without drill hole HC-ADV-B24-HHWH-BLANK-ELC-AL	1420056	1																
	1x M32	Powder-coated, black HC-ADV-B24-HHWH-1TTM25-MF-BK	1420925	1																
	1x M40	HC-ADV-B24-HHWH-1TTM32-MF-BK	1420926	1																
Sleeve housing¹⁾ Height: 74 mm 	1x M25	Uncoated, EMC ready HC-ADV-B24-HLWH-1STM25-EMC-AL	1414983	1																
	1x M25	HC-ADV-B24-HLWH-BLANK-ELC-AL	1420055	1																
	1x M25	Powder-coated, black HC-ADV-B24-HLWH-1STM25-MF-BK	1420928	1																
Sleeve housing¹⁾ Height: 93.7 mm 	1x M25	Uncoated, EMC ready HC-ADV-B24-HHWH-1STM25-EMC-AL	1414981	1																
	1x M32	HC-ADV-B24-HHWH-1STM32-EMC-AL	1413431	1																
	1x M40	HC-ADV-B24-HHWH-1STM40-EMC-AL	1413433	1																
	1x M25	Uncoated, EMC ready, without drill hole HC-ADV-B24-HHWH-BLANK-ELC-AL	1420056	1																
	1x M32	Powder-coated, black HC-ADV-B24-HHWH-1STM25-MF-BK	1420922	1																
	1x M40	HC-ADV-B24-HHWH-1STM32-MF-BK	1420923	1																
Panel mounting flange 		2 pcs. per housing HC-B-AF	1686533	20	 <table border="1" data-bbox="1189 1533 1340 1585"> <tr> <td></td> <td>B06</td> <td>B10</td> <td>B16</td> <td>B24</td> </tr> <tr> <td>a</td> <td>70</td> <td>83</td> <td>103</td> <td>130</td> </tr> <tr> <td>b</td> <td>52</td> <td>65</td> <td>86</td> <td>112</td> </tr> </table>		B06	B10	B16	B24	a	70	83	103	130	b	52	65	86	112
		B06	B10	B16		B24														
a	70	83	103	130																
b	52	65	86	112																
		Set with 2 panel mounting flanges HC-B-AF-SET	1604638	1																
Protective cover Height: 31.2 mm 		for sleeve side, IP50 HC-B 24-TMS-SD-IP50	1690765	10																
		for panel mounting side, IP66 HC-B 24-TMS-SD-IP66	1411520	10																

Notes:
In order to achieve optimum shielding results, the mounting surface must be conductive
Marking label: US-EMLP-HA (20X9), Order No. 0830989
¹⁾ Screw locking with M6 Allen screws

Accessories

		
Cable glands From page 686	Allen keys see Catalog 3	Replacement seals phoenixcontact.net/products

Heavy-duty connectors

HEAVYCON B – housings

Size B24, plastic, EVO housings, single locking latch



General data

Housing material	PA
Locking latch material	PA
Sealing material	NBR
IP degree of protection (when plugged in)	IP66
NEMA degree of protection (when plugged in)	12
Ambient temperature (operation)	-40°C ... 125°C

Technical data

Ordering data

Description	Thread
-------------	--------

Sleeve housing
Height: 63 mm



Sleeve housing
Height: 87.5 mm



Panel mounting base
Height: 30.5 mm



Box mounting base¹⁾
Height: 84 mm



Coupling housing
Height: 90 mm



Cable gland



Clamping area

7 mm ... 13 mm
9 mm ... 17 mm
11 mm ... 21 mm
19 mm ... 28 mm

Type	Order No.	Pcs./Pkt.
------	-----------	-----------

HC-EVO-B24-HLFS-PLBK

1420934

1

HC-EVO-B24-HHFS-PLBK

1407656

1

Without cover
HC-EVO-B24-BWS-PLRBK

1407659

1

With cover
HC-EVO-B24-BWSC-PLRBK

1407660

1

Without cover
HC-EVO-B24-SHWS-2SSM25-PLRBK

1421459

1

HC-EVO-B24-SHWS-2SSM32-PLRBK

1421367

1

HC-EVO-B24-SHWS-2SSM40-PLRBK

1407663

1

With cover
HC-EVO-B24-SHWSC-2SSM25-PLRBK

1421460

1

HC-EVO-B24-SHWSC-2SSM32-PLRBK

1421369

1

HC-EVO-B24-SHWSC-2SSM40-PLRBK

1407664

1

HC-EVO-B24-CHWS-PLRBK

1407667

1

HC-B-G-M20-PLRBK

1407669

1

HC-B-G-M25-PLRBK

1407670

1

HC-B-G-M32-PLRBK

1407671

1

HC-B-G-M40-PLRBK

1407672

1

Dimensions

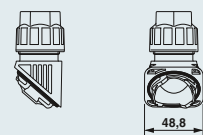
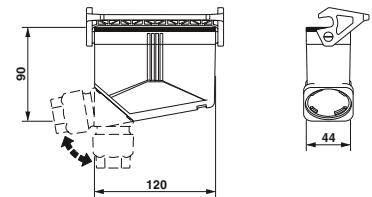
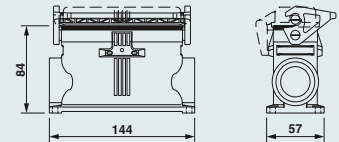
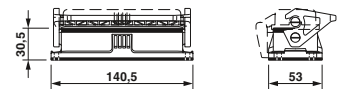
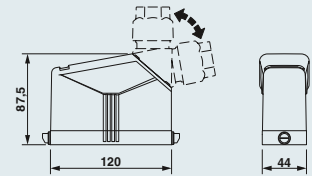
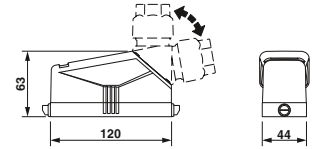

Notes:

For further accessories, see from page 658

Marking label: US-EMP (20X9) Order No. 0829439

¹⁾ One cable entry is sealed with a knockout cover

Accessories



EVO unlocking tools
From page 659



Thread adapters
From page 659



Replacement seals
phoenixcontact.net/products











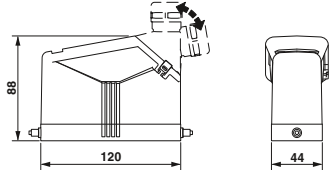

Connector seals
From page 646

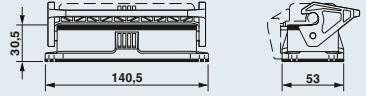
Size B24, metal, EVO housings, single locking latch

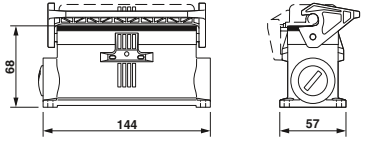

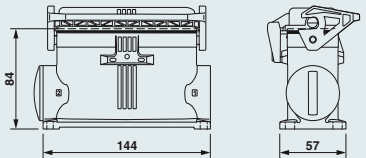
General data	
Housing material	Die-cast aluminum, salt water resistant
Locking latch material	Polyamide
Sealing material	NBR, conductive
IP degree of protection (when plugged in)	IP66 / IP67
NEMA degree of protection (when plugged in)	4 / 4X / 12
Ambient temperature (operation)	-40°C ... 125°C

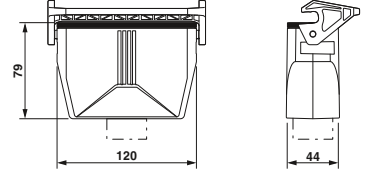
Technical data	
Housing material	Die-cast aluminum, salt water resistant
Locking latch material	Polyamide
Sealing material	NBR, conductive
IP degree of protection (when plugged in)	IP66 / IP67
NEMA degree of protection (when plugged in)	4 / 4X / 12
Ambient temperature (operation)	-40°C ... 125°C

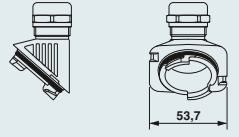
Description		Thread	Type	Order No.	Pcs./Pkt.	Dimensions
Sleeve housing Height: 88 mm 			HC-EVO-B24-HHFS-EL-AL	1411473	1	
Panel mounting base Height: 30.5 mm 			Without cover HC-STA-B24-BWS-ELC-AL With cover HC-STA-B24-BWSC-ELC-AL	1411329 1411330	1 1	
Box mounting base¹⁾ Height: 68 mm 		2x M25 2x M32 2x Pg21	Without cover HC-STA-B24-SLWS-2SSM25-ELC-AL HC-STA-B24-SLWS-2SSM32-ELC-AL HC-STA-B24-SLWS-2SSP21-ELC-AL With cover HC-STA-B24-SLWSC-2SSM25-ELC-AL HC-STA-B24-SLWSC-2SSM32-ELC-AL HC-STA-B24-SLWSC-2SSP21-ELC-AL	1412877 1412878 1412879 1412881 1412882 1412883	1 1 1 1 1 1	
Box mounting base¹⁾ Height: 84.7 mm 		2x M32 2x M40 2x M25 2x M32 2x M40	Without cover HC-STA-B24-SHWS-2SSM32-ELC-AL HC-STA-B24-SHWS-2SSM40-ELC-AL With cover HC-STA-B24-SHWSC-2SSM25-ELC-AL HC-STA-B24-SHWSC-2SSM32-ELC-AL HC-STA-B24-SHWSC-2SSM40-ELC-AL	1082592 1082593 1082595 1082596 1082597	1 1 1 1 1	
Coupling housing Height: 79 mm 		1x M32 1x M40 1x Pg21 1x Pg29	Cable outlet: top HC-STA-B24-CHWS-1TTM32-ELC-AL HC-STA-B24-CHWS-1TTM40-ELC-AL HC-STA-B24-CHWS-1TTP21-ELC-AL HC-STA-B24-CHWS-1TTP29-ELC-AL	1412746 1412747 1412748 1412749	1 1 1 1	
Cable gland 		Clamping area 9 mm ... 13 mm 11 mm ... 16 mm 14 mm ... 21 mm 19 mm ... 27 mm	HC-B-G-M20-EC-AL HC-B-G-M25-EC-AL HC-B-G-M32-EC-AL HC-B-G-M40-EC-AL	1411439 1411446 1411440 1411441	1 1 1 1	

Notes:
For further accessories, see from page 658
Marking label: US-EMLP-HA (20X9), Order No. 0830989
¹⁾ Supplied with a plastic sealing cap

Ordering data		
Type	Order No.	Pcs./Pkt.

Accessories

 EMC cable glands From page 660	 Cable glands From page 686	 Replacement seals phoenixcontact.net/products	 Connector sets phoenixcontact.net/products
---	---	---	--

Heavy-duty connectors

HEAVYCON B – housings

Size B24, metal, sleeve housings for single locking latch







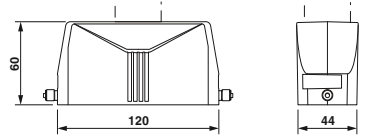

General data

Housing material
Locking latch material
Sealing material
IP degree of protection (when plugged in)
NEMA degree of protection (when plugged in)
Ambient temperature (operation)

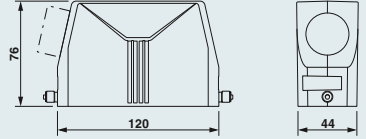
Technical data	
Housing material	Die-cast aluminum, salt water resistant
Locking latch material	-
Sealing material	-
IP degree of protection (when plugged in)	IP66 / IP67
NEMA degree of protection (when plugged in)	4 / 4X / 12
Ambient temperature (operation)	-40°C ... 125°C

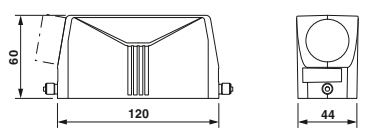
Ordering data

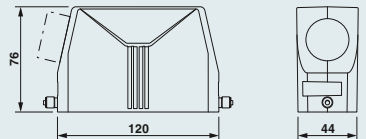
Description	Thread	Type	Order No.	Pcs./Pkt.	Dimensions
Sleeve housing Height: 60 mm 	1x M25 1x M32 1x Pg16 1x Pg21 1x Pg29	Cable outlet: top			
		HC-STA-B24-HLFS-1TTM25-EL-AL	1412788	1	
		HC-STA-B24-HLFS-1TTM32-EL-AL	1412789	1	
		HC-STA-B24-HLFS-1TTP16-EL-AL	1412790	1	
		HC-STA-B24-HLFS-1TTP21-EL-AL	1412791	1	
		HC-STA-B24-HLFS-1TTP29-EL-AL	1412792	1	
without bore hole					
HC-STA-B24-HLFS-BLANK-EL-AL	1419937	1			
Sleeve housing Height: 76 mm 	1x M32 1x M40 1x Pg21 1x Pg29	Cable outlet: top			
		HC-STA-B24-HHFS-1TTM32-EL-AL	1412761	1	
		HC-STA-B24-HHFS-1TTM40-EL-AL	1412098	1	
		HC-STA-B24-HHFS-1TTP21-EL-AL	1412762	1	
		HC-STA-B24-HHFS-1TTP29-EL-AL	1412763	1	
		without bore hole			
HC-STA-B24-HHFS-BLANK-EL-AL	1419957	1			
Sleeve housing Height: 60 mm 	1x M25 1x M32 1x Pg16 1x Pg21	Cable outlet: lateral			
		HC-STA-B24-HLFS-1STM25-EL-AL	1412783	1	
		HC-STA-B24-HLFS-1STM32-EL-AL	1412784	1	
		HC-STA-B24-HLFS-1STP16-EL-AL	1412785	1	
		HC-STA-B24-HLFS-1STP21-EL-AL	1412786	1	
		without bore hole			
HC-STA-B24-HLFS-BLANK-EL-AL	1419937	1			
Sleeve housing Height: 76 mm 	1x M32 1x M40 1x Pg21 1x Pg29	Cable outlet: lateral			
		HC-STA-B24-HHFS-1STM32-EL-AL	1412757	1	
		HC-STA-B24-HHFS-1STM40-EL-AL	1412758	1	
		HC-STA-B24-HHFS-1STP21-EL-AL	1412759	1	
		HC-STA-B24-HHFS-1STP29-EL-AL	1412760	1	
		without bore hole			
HC-STA-B24-HHFS-BLANK-EL-AL	1419957	1			

Notes:
For further accessories, see from page 658
Marking label: US-EMLP-HA (20X9), Order No. 0830989

Accessories

 Cable glands From page 686	 Protective covers From page 654	 Cover plates From page 664	 Connector sets From page 647
---	--	---	---

Size B24, metal, supporting base elements with single locking latch



General data		Technical data	
Housing material		Die-cast aluminum, salt water resistant	
Locking latch material		PA	
Sealing material		NBR, conductive	
IP degree of protection (when plugged in)		IP66 / IP67	
NEMA degree of protection (when plugged in)		4 / 4X / 12	
Ambient temperature (operation)		-40°C ... 125°C	

Description		Thread	Type	Order No.	Pcs./Pkt.	Dimensions
Panel mounting base Height: 30.5 mm			Without cover HC-STA-B24-BWS-ELC-AL	1411329	1	 30.5 mm height, 140.5 mm width, 53 mm depth.
			With cover HC-STA-B24-BWSC-ELC-AL	1411330	1	
Box mounting base¹⁾ Height: 68 mm		2x M25 2x M32 2x Pg21	Without cover HC-STA-B24-SLWS-2SSM25-ELC-AL HC-STA-B24-SLWS-2SSM32-ELC-AL HC-STA-B24-SLWS-2SSP21-ELC-AL	1412877 1412878 1412879	1 1 1	 68 mm height, 144 mm width, 57 mm depth.
		2x M25 2x M32 2x Pg21	With cover HC-STA-B24-SLWSC-2SSM25-ELC-AL HC-STA-B24-SLWSC-2SSM32-ELC-AL HC-STA-B24-SLWSC-2SSP21-ELC-AL	1412881 1412882 1412883	1 1 1	
Box mounting base¹⁾ Height: 84.7 mm		2x M25 2x M32 2x M40	HC-STA-B24-SHWS-2SSM25-ELC-AL HC-STA-B24-SHWS-2SSM32-ELC-AL HC-STA-B24-SHWS-2SSM40-ELC-AL	1085185 1082592 1082593	1 1 1	
		2x M25 2x M32 2x M40	With cover HC-STA-B24-SHWSC-2SSM25-ELC-AL HC-STA-B24-SHWSC-2SSM32-ELC-AL HC-STA-B24-SHWSC-2SSM40-ELC-AL	1082595 1082596 1082597	1 1 1	 84 mm height, 144 mm width, 57 mm depth.
Coupling housing Height: 79 mm		1x M32 1x M40 1x Pg21 1x Pg29	Cable outlet: top HC-STA-B24-CHWS-1TTM32-ELC-AL HC-STA-B24-CHWS-1TTM40-ELC-AL HC-STA-B24-CHWS-1TTP21-ELC-AL HC-STA-B24-CHWS-1TTP29-ELC-AL	1412746 1412747 1412748 1412749	1 1 1 1	

Notes:
For further accessories, see from page 658
¹⁾ Supplied with a plastic sealing cap

Accessories

Cable glands From page 686	Replacement seals phoenixcontact.net/products	Replacement protective covers phoenixcontact.net/products	Replacement latches phoenixcontact.net/products

Heavy-duty connectors

HEAVYCON B – housings

Size B24, plastic, EVO housings, double locking latch



General data

Housing material	PA
Locking latch material	PA
Sealing material	NBR
IP degree of protection (when plugged in)	IP66
NEMA degree of protection (when plugged in)	12
Ambient temperature (operation)	-40°C ... 125°C

Technical data

Ordering data

Description	Thread
-------------	--------

Sleeve housing Height: 63 mm	
---------------------------------	--



Sleeve housing Height: 87.5 mm	
-----------------------------------	--



Double sleeve housing Height: 87.5 mm	
--	--



Panel mounting base Height: 30.5 mm	
--	--



Box mounting base ¹⁾ Height: 84 mm	2x M25 2x M32 2x M40
--	----------------------------



Coupling housing Height: 90 mm	
-----------------------------------	--



Type	Order No.	Pcs./Pkt.
HC-EVO-B24-HLFD-PLBK	1420935	1
HC-EVO-B24-HHFD-PLBK	1407657	1
for double locking latch HC-EVO-B24-HHFD-2B-PL-BK	1411497	1
Without cover HC-EVO-B24-BWD-PLRBK	1407661	1
Without cover HC-EVO-B24-SHWD-2SSM25-PLRBK	1421461	1
HC-EVO-B24-SHWD-2SSM32-PLRBK	1421370	1
HC-EVO-B24-SHWD-2SSM40-PLRBK	1407665	1
HC-EVO-B24-CHWD-PLRBK	1407668	1

Dimensions

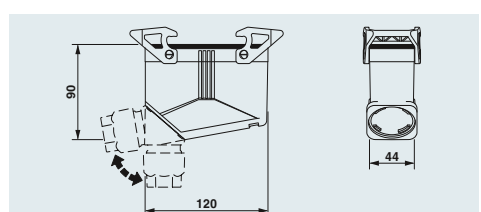
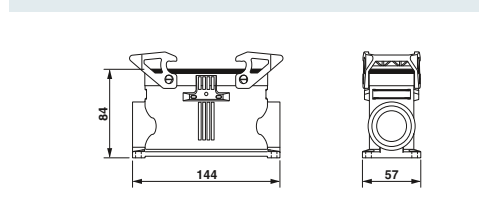
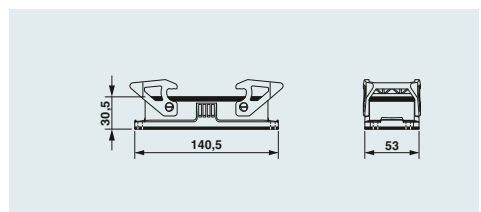
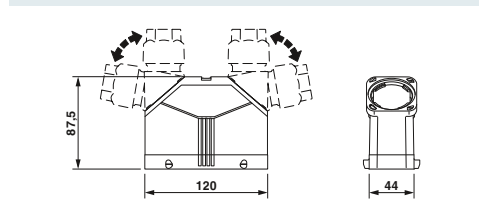
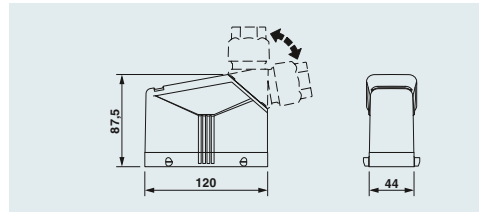
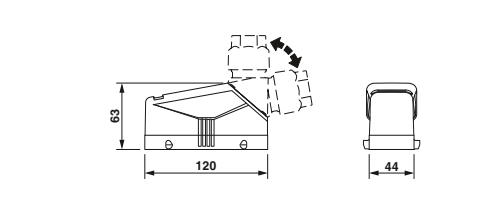

Notes:

- For further accessories, see from page 654
- Marking label: US-EMP (20X9) Order No. [0829439](#)
- For coupling housings, visit phoenixcontact.net/products
- ¹⁾ One cable entry is sealed with a knockout cover

Accessories



Cable glands
From page 658



Thread adapters
From page 659



Replacement seals
phoenixcontact.net/products



Connector sets
From page 646

Size B24, metal, EVO housings, double locking latch









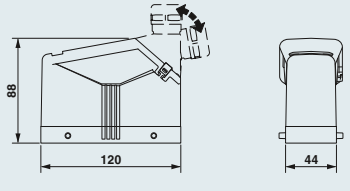

Technical data

General data

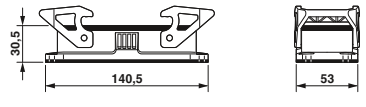
Housing material
Locking latch material
Sealing material
IP degree of protection (when plugged in)
NEMA degree of protection (when plugged in)
Ambient temperature (operation)

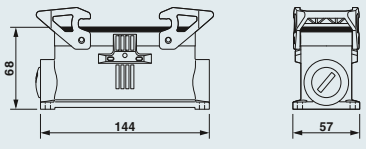
Die-cast aluminum, salt water resistant
PA
NBR, conductive
IP66 / IP67
4 / 4X / 12
-40°C ... 125°C

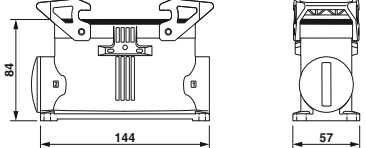
Ordering data

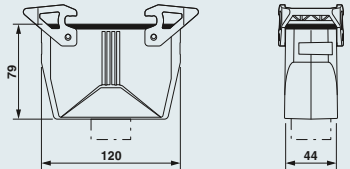
Description	Thread	Type	Order No.	Pcs./Pkt.	Dimensions
Sleeve housing Height: 88 mm 		HC-EVO-B24-HHFD-EL-AL	1411472	1	
Panel mounting base Height: 30.5 mm 		Without cover HC-STA-B24-BWD-ELC-AL	1411331	1	
Box mounting base¹⁾ Height: 68 mm 	2x M25 2x M32 2x Pg21	Without cover HC-STA-B24-SLWD-2SSM25-ELC-AL HC-STA-B24-SLWD-2SSM32-ELC-AL HC-STA-B24-SLWD-2SSP21-ELC-AL	1412873 1412874 1412875	1 1 1	
Box mounting base¹⁾ Height: 84.7 mm 	2x M25 2x M32 2x M40	Without cover HC-STA-B24-SHWD-2SSM25-ELC-AL HC-STA-B24-SHWD-2SSM32-ELC-AL HC-STA-B24-SHWD-2SSM40-ELC-AL	1082603 1082604 1082605	1 1 1	
Coupling housing Height: 77 mm 	1x M32 1x M40 1x Pg21 1x Pg29	Cable outlet: top HC-STA-B24-CHWD-1TTM32-ELC-AL HC-STA-B24-CHWD-1TTM40-ELC-AL HC-STA-B24-CHWD-1TTP21-ELC-AL HC-STA-B24-CHWD-1TTP29-ELC-AL	1412742 1412743 1412744 1412745	1 1 1 1	

Notes:

For further accessories, see from page 658

Marking label: US-EMLP-HA (20X9), Order No. 0830989

¹⁾ Supplied with a plastic sealing cap

Accessories



Cable glands
From page 660



Cable glands
From page 686



Replacement seals
phoenixcontact.net/products



Connector sets
phoenixcontact.net/products

Heavy-duty connectors

HEAVYCON B – housings

Size B24, metal, sleeve housings for double locking latch









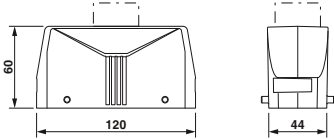

new

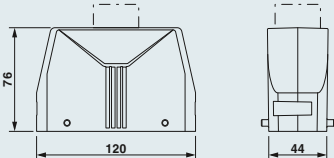

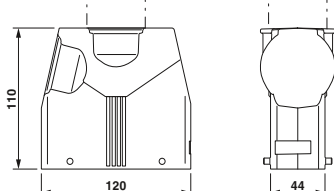
General data	
Housing material	Die-cast aluminum, salt water resistant
Locking latch material	-
Sealing material	-
IP degree of protection (when plugged in)	IP66 / IP67
NEMA degree of protection (when plugged in)	4 / 4X / 12
Ambient temperature (operation)	-40°C ... 125°C

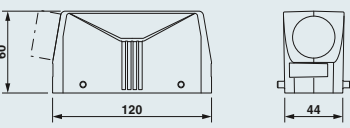
Technical data	
Housing material	Die-cast aluminum, salt water resistant
Locking latch material	-
Sealing material	-
IP degree of protection (when plugged in)	IP66 / IP67
NEMA degree of protection (when plugged in)	4 / 4X / 12
Ambient temperature (operation)	-40°C ... 125°C

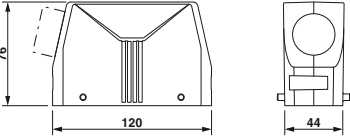
Ordering data

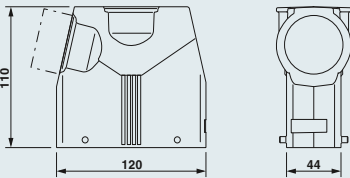
Description	Thread	Type	Order No.	Pcs./Pkt.	Dimensions	
Sleeve housing Height: 60 mm 	1x M25 1x M32 1x Pg16 1x Pg21 1x Pg29	Cable outlet: top				
		HC-STA-B24-HLFD-1TTM25-EL-AL	1412778	1		
		HC-STA-B24-HLFD-1TTM32-EL-AL	1412779	1		
		HC-STA-B24-HLFD-1TTP16-EL-AL	1412780	1		
		HC-STA-B24-HLFD-1TTP21-EL-AL	1412781	1		
		HC-STA-B24-HLFD-1TTP29-EL-AL	1412782	1		
		without bore hole				
HC-STA-B24-HLFD-BLANK-EL-AL	1420010	1				
Sleeve housing Height: 76 mm 	1x M32 1x M40 1x Pg21 1x Pg29	Cable outlet: top				
		HC-STA-B24-HHFD-1TTM32-EL-AL	1412754	1		
		HC-STA-B24-HHFD-1TTM40-EL-AL	1412099	1		
		HC-STA-B24-HHFD-1TTP21-EL-AL	1412755	1		
		HC-STA-B24-HHFD-1TTP29-EL-AL	1412756	1		
		without bore hole				
		HC-STA-B24-HHFD-BLANK-EL-AL	1420011	1		
Sleeve housing Height: 110.8 mm 	1x M50	Cable outlet: top				
		HC-STA-B24-HHFD-1TTM50-EL-AL	1082554	1		
Sleeve housing Height: 60 mm 	1x M25 1x M32 1x Pg16 1x Pg21	Cable outlet: lateral				
		HC-STA-B24-HLFD-1STM25-EL-AL	1412773	1		
		HC-STA-B24-HLFD-1STM32-EL-AL	1412774	1		
		HC-STA-B24-HLFD-1STP16-EL-AL	1412775	1		
		HC-STA-B24-HLFD-1STP21-EL-AL	1412776	1		
		without bore hole				
		HC-STA-B24-HLFD-BLANK-EL-AL	1420010	1		
Sleeve housing Height: 76 mm 	1x M32 1x M40 1x Pg21 1x Pg29	Cable outlet: lateral				
		HC-STA-B24-HHFD-1STM32-EL-AL	1412750	1		
		HC-STA-B24-HHFD-1STM40-EL-AL	1412751	1		
		HC-STA-B24-HHFD-1STP21-EL-AL	1412752	1		
		HC-STA-B24-HHFD-1STP29-EL-AL	1412753	1		
		without bore hole				
		HC-STA-B24-HHFD-BLANK-EL-AL	1420011	1		
Sleeve housing Height: 110.8 mm 	1x M50	Cable outlet: lateral				
		HC-STA-B24-HHFD-1STM50-EL-AL	1082553	1		

Notes:
For further accessories, see from page 658
Marking label: US-EMLP-HA (20X9), Order No. 0830989

Accessories





 Cable glands From page 686	 Protective covers From page 654	 Cover plates From page 664	 Connector sets From page 647
---	--	---	---

Size B24, metal, base elements with double locking latch



General data	
Housing material	Die-cast aluminum, salt water resistant
Locking latch material	PA
Sealing material	NBR, conductive
IP degree of protection (when plugged in)	IP66 / IP67
NEMA degree of protection (when plugged in)	4 / 4X / 12
Ambient temperature (operation)	-40°C ... 125°C

Technical data	
Housing material	Die-cast aluminum, salt water resistant
Locking latch material	PA
Sealing material	NBR, conductive
IP degree of protection (when plugged in)	IP66 / IP67
NEMA degree of protection (when plugged in)	4 / 4X / 12
Ambient temperature (operation)	-40°C ... 125°C

Description		Thread	Type	Order No.	Pcs./Pkt.	Dimensions	
Panel mounting base Height: 30.5 mm 			Without cover HC-STA-B24-BWD-ELC-AL	1411331	1		
Box mounting base¹⁾ Height: 68 mm 		2x M25 2x M32 2x Pg21	Without cover HC-STA-B24-SLWD-2SSM25-ELC-AL HC-STA-B24-SLWD-2SSM32-ELC-AL HC-STA-B24-SLWD-2SSP21-ELC-AL	1412873 1412874 1412875	1 1 1		
Box mounting base¹⁾ Height: 84.7 mm 		2x M25 2x M32 2x M40	Without cover HC-STA-B24-SHWD-2SSM25-ELC-AL HC-STA-B24-SHWD-2SSM32-ELC-AL HC-STA-B24-SHWD-2SSM40-ELC-AL	1082603 1082604 1082605	1 1 1		
Coupling housing Height: 77 mm 		1x M32 1x M40 1x Pg21 1x Pg29	Cable outlet: top HC-STA-B24-CHWD-1TTM32-ELC-AL HC-STA-B24-CHWD-1TTM40-ELC-AL HC-STA-B24-CHWD-1TTP21-ELC-AL HC-STA-B24-CHWD-1TTP29-ELC-AL	1412742 1412743 1412744 1412745	1 1 1 1		

Notes:
For further accessories, see from page 658
¹⁾ Supplied with a plastic sealing cap

Accessories

			
Cable glands From page 686	Replacement seals phoenixcontact.net/products	Replacement protective covers phoenixcontact.net/products	Replacement latches phoenixcontact.net/products

Heavy-duty connectors

HEAVYCON B – housings

Size B24, plastic, EVO housings, double locking latch









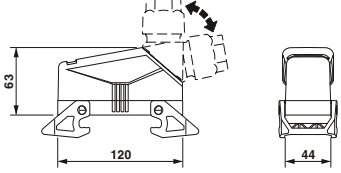

General data

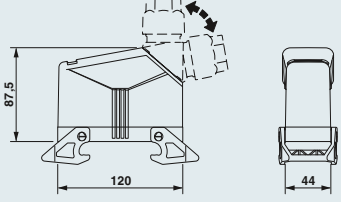
Housing material	PA
Locking latch material	PA
Sealing material	NBR
IP degree of protection (when plugged in)	IP66
NEMA degree of protection (when plugged in)	12
Ambient temperature (operation)	-40°C ... 125°C

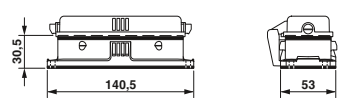
Technical data

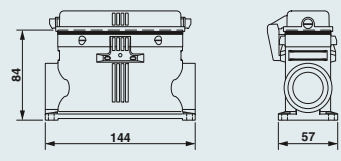
Ordering data

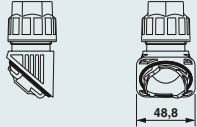
Description	Thread	Type	Order No.	Pcs./Pkt.	Dimensions
Sleeve housing Height: 63 mm 		HC-EVO-B24-HLWD-PLBK	1420936	1	
Sleeve housing Height: 87.5 mm 		HC-EVO-B24-HHWD-PLBK	1407658	1	
Panel mounting base Height: 30.5 mm 		With cover HC-EVO-B24-BFDC-PLRBK	1407662	1	
Box mounting base¹⁾ Height: 84 mm 	2x M25 2x M32 2x M40	With cover HC-EVO-B24-SHFDC-2SSM25-PLRBK HC-EVO-B24-SHFDC-2SSM32-PLRBK HC-EVO-B24-SHFDC-2SSM40-PLRBK	1421462 1421380 1407666	1 1 1	
Cable gland 	Clamping area 7 mm ... 13 mm 9 mm ... 17 mm 11 mm ... 21 mm 19 mm ... 28 mm	HC-B-G-M20-PLRBK HC-B-G-M25-PLRBK HC-B-G-M32-PLRBK HC-B-G-M40-PLRBK	1407669 1407670 1407671 1407672	1 1 1 1	

Notes:

For further accessories, see from page 654

Marking label: US-EMP (20X9) Order No. [0829439](#)

For coupling housings, visit phoenixcontact.net/products

¹⁾ One cable entry is sealed with a knockout cover

Accessories



EVO unlocking tools
From page 659



Thread adapters
From page 659



Replacement seals
phoenixcontact.net/products



Replacement latches
phoenixcontact.net/products







Size B24, metal, EVO housings, double locking latch

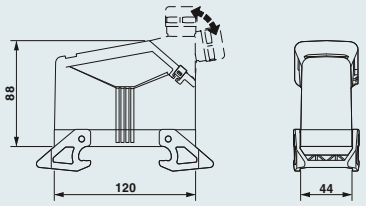

Technical data

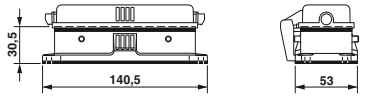
General data	
Housing material	Die-cast aluminum, salt water resistant
Locking latch material	Polyamide
Sealing material	NBR, conductive
IP degree of protection (when plugged in)	IP66 / IP67
NEMA degree of protection (when plugged in)	4 / 4X / 12
Ambient temperature (operation)	-40°C ... 125°C

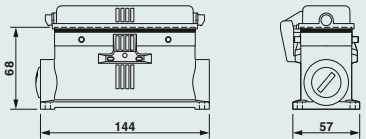
Ordering data

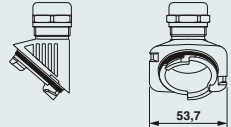
Description	Thread	Type	Order No.	Pcs./Pkt.	Dimensions
Sleeve housing Height: 88 mm 		HC-EVO-B24-HHWD-EL-AL	1411474	1	
Panel mounting base Height: 30.5 mm 		With cover HC-STA-B24-BFDC-ELC-AL	1411332	1	
Box mounting base¹⁾ Height: 68 mm 	2x M25 2x M32 2x Pg21	With cover HC-STA-B24-SLFDC-2SSM25-ELC-AL HC-STA-B24-SLFDC-2SSM32-ELC-AL HC-STA-B24-SLFDC-2SSP21-ELC-AL	1412869 1412870 1412871	1 1 1	
Cable gland 	Clamping area 9 mm ... 13 mm 11 mm ... 16 mm 14 mm ... 21 mm 19 mm ... 27 mm	HC-B-G-M20-EC-AL HC-B-G-M25-EC-AL HC-B-G-M32-EC-AL HC-B-G-M40-EC-AL	1411439 1411446 1411440 1411441	1 1 1 1	

Notes:

For further accessories, see from page 658

Marking label: US-EMLP-HA (20X9), Order No. 0830989

¹⁾ Supplied with a plastic sealing cap

Accessories



Thread adapters
From page 660



EMC cable glands
From page 660



Replacement seals
phoenixcontact.net/products



Replacement latches
phoenixcontact.net/products

Heavy-duty connectors

HEAVYCON B – housings

Size B24, metal, sleeve housings with double locking latch







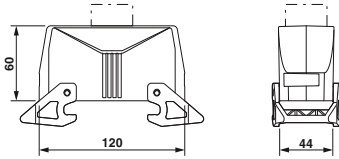

General data

Housing material
Locking latch material
Sealing material
IP degree of protection (when plugged in)
NEMA degree of protection (when plugged in)
Ambient temperature (operation)

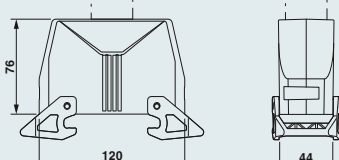
Technical data	
Die-cast aluminum, salt water resistant	
PA	
-	
IP66 / IP67	
4 / 4X / 12	
-40°C ... 125°C	

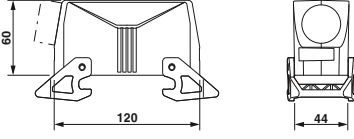
Ordering data

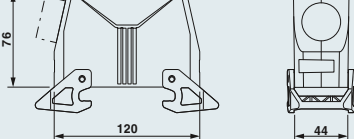
Description	Thread	Type	Order No.	Pcs./Pkt.	Dimensions
Sleeve housing Height: 60 mm 	1x M25 1x M32 1x Pg16 1x Pg21 1x Pg29	Cable outlet: top			
		HC-STA-B24-HLWD-1TTM25-EL-AL	1412799	1	
		HC-STA-B24-HLWD-1TTM32-EL-AL	1412800	1	
		HC-STA-B24-HLWD-1TTP16-EL-AL	1412801	1	
		HC-STA-B24-HLWD-1TTP21-EL-AL	1412802	1	
		HC-STA-B24-HLWD-1TTP29-EL-AL	1412803	1	
without bore hole					
HC-STA-B24-HLWD-BLANK-EL-AL	1420046	1			
Sleeve housing Height: 76 mm 	1x M32 1x M40 1x Pg21 1x Pg29	Cable outlet: top			
		HC-STA-B24-HHWD-1TTM32-EL-AL	1412769	1	
		HC-STA-B24-HHWD-1TTM40-EL-AL	1412770	1	
		HC-STA-B24-HHWD-1TTP21-EL-AL	1412771	1	
		HC-STA-B24-HHWD-1TTP29-EL-AL	1412772	1	
		without bore hole			
HC-STA-B24-HHWD-BLANK-EL-AL	1420047	1			
Sleeve housing Height: 60 mm 	1x M25 1x M32 1x Pg16 1x Pg21	Cable outlet: lateral			
		HC-STA-B24-HLWD-1STM25-EL-AL	1412793	1	
		HC-STA-B24-HLWD-1STM32-EL-AL	1412795	1	
		HC-STA-B24-HLWD-1STP16-EL-AL	1412796	1	
		HC-STA-B24-HLWD-1STP21-EL-AL	1412797	1	
		without bore hole			
HC-STA-B24-HLWD-BLANK-EL-AL	1420046	1			
Sleeve housing Height: 76 mm 	1x M32 1x M40 1x Pg21 1x Pg29	Cable outlet: lateral			
		HC-STA-B24-HHWD-1STM32-EL-AL	1412764	1	
		HC-STA-B24-HHWD-1STM40-EL-AL	1412766	1	
		HC-STA-B24-HHWD-1STP21-EL-AL	1412767	1	
		HC-STA-B24-HHWD-1STP29-EL-AL	1412768	1	
		without bore hole			
HC-STA-B24-HHWD-BLANK-EL-AL	1420047	1			

Notes:
For further accessories, see from page 658
Marking label: US-EMLP-HA (20X9), Order No. 0830989

Accessories



 Cable glands From page 686	 Protective covers From page 654	 Replacement latches phoenixcontact.net/products
---	--	---

**Size B24, metal,
supporting base elements
for double locking latch**



General data	
Housing material	Die-cast aluminum, salt water resistant
Locking latch material	PA
Sealing material	NBR, conductive
IP degree of protection (when plugged in)	IP66 / IP67
NEMA degree of protection (when plugged in)	4 / 4X / 12
Ambient temperature (operation)	-40°C ... 125°C

Technical data	
Housing material	Die-cast aluminum, salt water resistant
Locking latch material	PA
Sealing material	NBR, conductive
IP degree of protection (when plugged in)	IP66 / IP67
NEMA degree of protection (when plugged in)	4 / 4X / 12
Ambient temperature (operation)	-40°C ... 125°C

Description		Thread	Type	Order No.	Pcs./Pkt.
Panel mounting base Height: 30.5 mm 			With cover HC-STA-B24-BFDC-ELC-AL	1411332	1
Box mounting base¹⁾ Height: 68 mm 		2x M25 2x M32 2x Pg21	With cover HC-STA-B24-SLFDC-2SSM25-ELC-AL HC-STA-B24-SLFDC-2SSM32-ELC-AL HC-STA-B24-SLFDC-2SSP21-ELC-AL	1412869 1412870 1412871	1 1 1

Dimensions	

Notes:
For further accessories, see from page 658
¹⁾ Supplied with a plastic sealing cap

Accessories			
 Cable glands From page 686	 Replacement seals phoenixcontact.net/products	 Replacement protective covers phoenixcontact.net/products	 Cover plates From page 664

Heavy-duty connectors

HEAVYCON B – housings

Size B32, metal, housings, double locking latch

new

General data







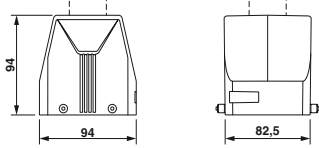

Housing material
Locking latch material
Sealing material
IP degree of protection (when plugged in)
Ambient temperature (operation)

Technical data

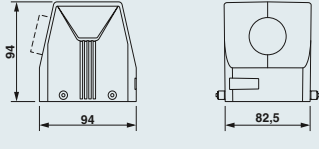
Die-cast aluminum, salt water resistant
Polyamide
NBR, conductive
IP66 / IP67
-40°C ... 125°C

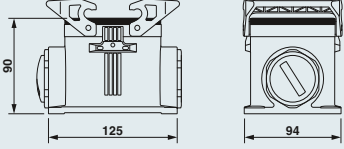

Ordering data

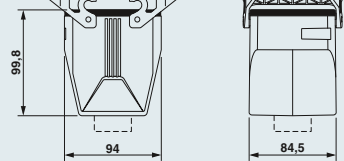
Description	Thread	Type	Order No.	Pcs./Pkt.	Dimensions
Sleeve housing Height: 94 mm 	1x M32 1x M40 1x M50 1x Pg29 1x Pg36 1x Pg42	Cable outlet: top			
		HC-STA-B32-HHFD-1TTM32-EL-AL	1424830	1	
		HC-STA-B32-HHFD-1TTM40-EL-AL	1424831	1	
		HC-STA-B32-HHFD-1TTM50-EL-AL	1424832	1	
		HC-STA-B32-HHFD-1TTP29-EL-AL	1424827	1	
		HC-STA-B32-HHFD-1TTP36-EL-AL	1424828	1	
		HC-STA-B32-HHFD-1TTP42-EL-AL	1424829	1	
Sleeve housing Height: 94 mm 	1x M32 1x M40 1x M50 1x Pg29 1x Pg36 1x Pg42	Cable outlet: lateral			
		HC-STA-B32-HHFD-1STM32-EL-AL	1424836	1	
		HC-STA-B32-HHFD-1STM40-EL-AL	1424837	1	
		HC-STA-B32-HHFD-1STM50-EL-AL	1424838	1	
		HC-STA-B32-HHFD-1STP29-EL-AL	1424833	1	
		HC-STA-B32-HHFD-1STP36-EL-AL	1424834	1	
		HC-STA-B32-HHFD-1STP42-EL-AL	1424835	1	
Panel mounting base Height: 32.4 mm 		Without cover HC-STA-B32-BWD-ELC-AL	1424845	1	
Box mounting base¹⁾ Height: 90 mm 	2x M32 2x M40 2x Pg29 2x Pg36	Without cover			
		HC-STA-B32-SHWD-2SSM32-ELC-AL	1424848	1	
		HC-STA-B32-SHWD-2SSM40-ELC-AL	1424849	1	
		HC-STA-B32-SHWD-2SSP29-ELC-AL	1424846	1	
		HC-STA-B32-SHWD-2SSP36-ELC-AL	1424847	1	
Coupling housing Height: 99.8 mm 	1x M32 1x M40 1x M50 1x Pg29 1x Pg36 1x Pg42	Cable outlet: top			
		HC-STA-B32-CHWD-1TTM32-ELC-AL	1424842	1	
		HC-STA-B32-CHWD-1TTM40-ELC-AL	1424843	1	
		HC-STA-B32-CHWD-1TTM50-ELC-AL	1424844	1	
		HC-STA-B32-CHWD-1TTP29-ELC-AL	1424839	1	
		HC-STA-B32-CHWD-1TTP36-ELC-AL	1424840	1	
		HC-STA-B32-CHWD-1TTP42-ELC-AL	1424841	1	

Notes:

For further accessories, see from page 654

¹⁾ Supplied with a plastic sealing cap

Accessories



Cable glands
From page 686



Replacement seals
phoenixcontact.net/products



Replacement latches
phoenixcontact.net/products









Size B48, metal, housings, single locking latch

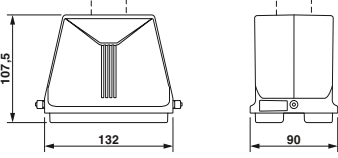

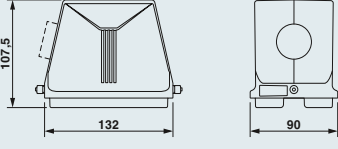
Technical data

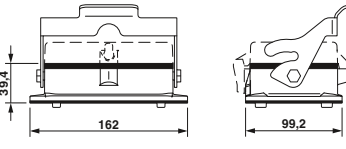
General data	
Housing material	Die-cast aluminum, salt water resistant
Locking latch material	Polyamide
Sealing material	NBR, conductive
IP degree of protection (when plugged in)	IP66 / IP67
Ambient temperature (operation)	-40°C ... 125°C

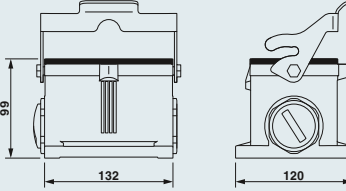
Ordering data

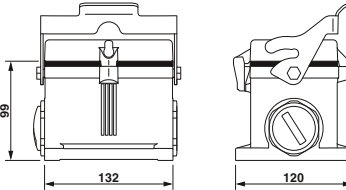
Description	Thread	Type	Order No.	Pcs./Pkt.	Dimensions
Sleeve housing Height: 107.5 mm 	1x M32 1x M40 1x M50 1x Pg29 1x Pg36 1x Pg42	Cable outlet: top			
		HC-STA-B48-HHFS-1TTM32-EM-AL	1424854	1	
		HC-STA-B48-HHFS-1TTM40-EM-AL	1424855	1	
		HC-STA-B48-HHFS-1TTM50-EM-AL	1424856	1	
		HC-STA-B48-HHFS-1TTP29-EM-AL	1424851	1	
		HC-STA-B48-HHFS-1TTP36-EM-AL	1424852	1	
HC-STA-B48-HHFS-1TTP42-EM-AL	1424853	1			
Sleeve housing Height: 107.5 mm 	1x M32 1x M40 1x M50 1x Pg29 1x Pg36 1x Pg42	Cable outlet: lateral			
		HC-STA-B48-HHFS-1STM32-EM-AL	1424860	1	
		HC-STA-B48-HHFS-1STM40-EM-AL	1424861	1	
		HC-STA-B48-HHFS-1STM50-EM-AL	1424862	1	
		HC-STA-B48-HHFS-1STP29-EM-AL	1424857	1	
		HC-STA-B48-HHFS-1STP36-EM-AL	1424858	1	
HC-STA-B48-HHFS-1STP42-EM-AL	1424859	1			
Panel mounting base Height: 39.4 mm 		Without cover	1424863	1	
		With cover	1424864	1	
Box mounting base¹⁾ Height: 99 mm 	2x M32 2x M40 2x Pg29 2x Pg36	Without cover			
		HC-STA-B48-SHWS-2SSM32-EMC-AL	1424867	1	
		HC-STA-B48-SHWS-2SSM40-EMC-AL	1424868	1	
		HC-STA-B48-SHWS-2SSP29-EMC-AL	1424865	1	
		HC-STA-B48-SHWS-2SSP36-EMC-AL	1424866	1	
Box mounting base¹⁾ Height: 99 mm 	2x M32 2x M40 2x Pg29 2x Pg36	With cover			
		HC-STA-B48-SHWSC-2SSM32-EMC-AL	1424873	1	
		HC-STA-B48-SHWSC-2SSM40-EMC-AL	1424874	1	
		HC-STA-B48-SHWSC-2SSP29-EMC-AL	1424869	1	
HC-STA-B48-SHWSC-2SSP36-EMC-AL	1424872	1			

Notes:

For further accessories, see from page 654

¹⁾ Supplied with a plastic sealing cap

Accessories



Cable glands
From page 686



Replacement seals
phoenixcontact.net/products



Replacement latches
phoenixcontact.net/products

Heavy-duty connectors

HEAVYCON B – housings

Connector sets, EVO housings, plastic, Push-in connection







General data

Housing material
Sealing material
Inflammability class in acc. with UL 94
Insertion/withdrawal cycles
IP degree of protection (when plugged in)
NEMA degree of protection (when plugged in)
Ambient temperature (operation)

Technical data

PA
NBR
V0
≥ 500
IP66
12
-40°C ... 125°C

Ordering data

Description	Pos.	Size	Type	Order No.	Pcs./Pkt.	Dimensions
Connector set 	6	B6	Single locking latch, with cover HC-EVO-B06PT-BWSC-HL-M20-PLRBK	1407710	1	
Connector set 	10	B10	Single locking latch, with cover HC-EVO-B10PT-BWSC-HL-M25-PLRBK	1408791	1	
	10	B10	Double locking latch, without cover HC-EVO-B10PT-BWD-HL-M25-PLRBK	1407711	1	
Connector set 	16	B16	Single locking latch, with cover HC-EVO-B16PT-BWSC-HH-M25-PLRBK	1408793	1	
	16	B16	Double locking latch, without cover HC-EVO-B16PT-BWD-HH-M25-PLRBK	1407712	1	
Connector set 	24	B24	Single locking latch, with cover HC-EVO-B24PT-BWSC-HH-M32-PLRBK	1408794	1	
	24	B24	Double locking latch, without cover HC-EVO-B24PT-BWD-HH-M32-PLRBK	1407713	1	

Notes: Accessories

For further accessories, see from page 654
Only operate connectors when there is no load/the power is switched off
For assembly instructions, see phoenixcontact.net/products
Connector sets: phoenixcontact.net/webcode/#0523



EVO unlocking tools
From page 659



Replacement latches
phoenixcontact.net/products



Replacement seals
phoenixcontact.net/products

**Connector sets,
STANDARD housings, metal,
Push-in connection**







General data	
Housing material	Die-cast aluminum, salt water resistant
Sealing material	NBR
Inflammability class in acc. with UL 94	V0
Insertion/withdrawal cycles	≥ 500
IP degree of protection (when plugged in)	IP66 / IP67
NEMA degree of protection (when plugged in)	-
Ambient temperature (operation)	-40°C ... 125°C

Technical data

Die-cast aluminum, salt water resistant
NBR
V0
≥ 500
IP66 / IP67
-
-40°C ... 125°C

Ordering data

Description	Pos.	Size	Type	Order No.	Pcs./Pkt.	Dimensions
Connector set, with single locking latch 	6	B6	Cable outlet: top, with cover HC-STA-B06PT-BWSC-LT-M20-ELCAL	1416344	1	
	6	B6	Cable outlet: to the side, with cover HC-STA-B06PT-BWSC-LS-M20-ELCAL	1416353	1	
Connector set, with double locking latch 	10	B10	Cable outlet: top, without cover HC-STA-B10PT-BWD-LT-M25-ELCAL	1416346	1	
	10	B10	Cable outlet: to the side, without cover HC-STA-B10PT-BWD-LS-M25-ELCAL	1416355	1	
Connector set, with double locking latch 	16	B16	Cable outlet: top, without cover HC-STA-B16PT-BWD-LT-M25-ELCAL	1416349	1	
	16	B16	Cable outlet: to the side, without cover HC-STA-B16PT-BWD-LS-M25-ELCAL	1416357	1	
Connector set, with double locking latch 	24	B24	Cable outlet: top, without cover HC-STA-B24PT-BWD-LT-M32-ELCAL	1416352	1	
	24	B24	Cable outlet: to the side, without cover HC-STA-B24PT-BWD-LS-M32-ELCAL	1416359	1	

Notes:
For further accessories, see from page 654
Only operate connectors when there is no load/the power is switched off
For assembly instructions, see phoenixcontact.net/products
Connector sets: phoenixcontact.net/webcode/#0523

Accessories



Replacement latches
phoenixcontact.net/products



Replacement seals
phoenixcontact.net/products

Heavy-duty connectors

HEAVYCON Compact – contact inserts

Compact series

Connection technology:



- Push-in connection
- Axial screw connection

To determine the corresponding housing, see the system cross-reference list on page 502.

Notes:
For accessories, see from page 654
Only operate connectors when there is no load/the power is switched off

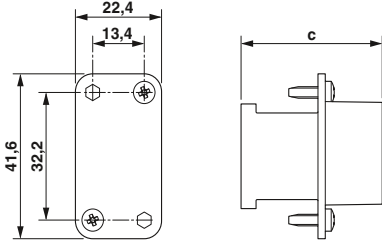

Type	Technical data			
	① HC-COM-Q08-I-PT...		② HC-COM-Q4/2-I-AT...	
	Power contacts	Control contacts	Power contacts	Control contacts
Approvals	-			
IEC data				
Rated current [A]	-	-	-	-
Overvoltage category		III		III
Degree of pollution		3		3
Rated voltage (III/3) contacts [V]	-	-	-	-
Rated surge voltage, contacts [kV]	-	-	-	-
Connection cross section [mm²]	-	-	-	-
UL data				
Rated voltage [V]	-	-	-	-
Rated current [A]	-	-	-	-
Connection cross section AWG	-	-	-	-
CSA / cUL data				
Rated voltage [V]	-	-	-	-
Rated current [A]	-	-	-	-
Connection cross section AWG	-	-	-	-
Material data				
Contact carrier material	PC		PC	
Inflammability class in acc. with UL 94	V0		V0	
Contact material	Copper alloy		Copper alloy	
Contact surface material	-	-	Ag	Ag (alternatively Au)
Temperature data				
Ambient temperature range [°C]	-40 ... 125		-40 ... 125	
General data				
Connection method	-	-	-	-
Stripping length [mm]	-	-	-	-
Number of positions	8	0	4	2
Contact numbering	-	-	-	-
Insertion/withdrawal cycles	≥ 500		≥ 500	

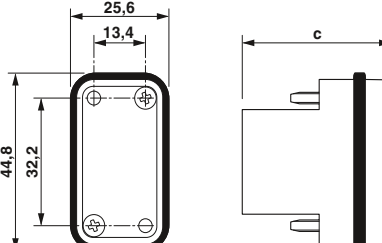
Description	Pos.	Number	Size	Ordering data			Pcs./Pkt.	Dimensions (in mm)	
				Type	Order No.				
					Female	Male			
Push-in connection 	8	1 - 8	COM	① HC-COM-Q08-I-PT...	1079554	1079553	1	 <p>Dimensional drawing: female</p>	
Axial screw connection 	4 / 2	1 - 4	COM	② HC-COM-Q4/2-I-AT...	1079557	1079558	1	 <p>Dimensional drawing: male</p>	

	a	b	c	d
① Female	45		48.05	
① Male				
② Female	42		48	
② Male				

Accessories



Dummy sockets
From page 657

Heavy-duty connectors

HEAVYCON Compact – contact inserts

Compact series

Connection technology:
– Crimp connection







To determine the corresponding housing, see the system cross-reference list on page 502.

Notes:
For accessories, see from page 654
Only operate connectors when there is no load/the power is switched off

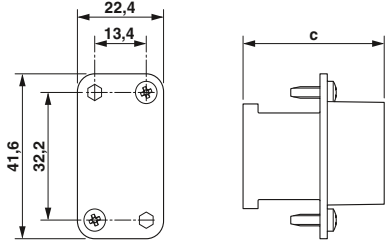
new

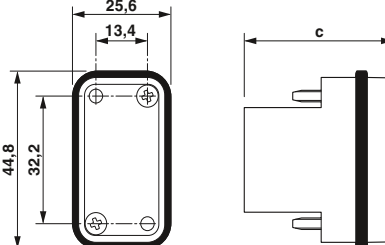

Type	Technical data			
	① HC-COM-Q08-I-CT...		② HC-COM-Q4/2-I-CT...	
	Power contacts	Control contacts	Power contacts	Control contacts
Approvals	-			
IEC data				
Rated current [A]	-	-	-	-
Overvoltage category		III		III
Degree of pollution		3		3
Rated voltage (III/3) contacts [V]	-	-	-	-
Rated surge voltage, contacts [kV]	-	-	-	-
Connection cross section [mm²]	-	-	-	-
UL data				
Rated voltage [V]	-	-	-	-
Rated current [A]	-	-	-	-
Connection cross section AWG	-	-	-	-
CSA / cUL data				
Rated voltage [V]	-	-	-	-
Rated current [A]	-	-	-	-
Connection cross section AWG	-	-	-	-
Material data				
Contact carrier material	PC		PC	
Inflammability class in acc. with UL 94	V0		V0	
Contact material	Copper alloy		Copper alloy	
Contact surface material	-	-	Ag	Ag (alternatively Au)
Temperature data				
Ambient temperature range [°C]	-40 ... 125		-40 ... 125	
General data				
Connection method	-	-	-	-
Stripping length [mm]	-	-	-	-
Number of positions	8	0	4	2
Contact numbering	-	-	-	-
Insertion/withdrawal cycles	≥ 500		≥ 500	

				Ordering data			Dimensions (in mm)		
Description	Pos.	Number	Size	Type	Order No.		Pcs./Pkt.		
					Female	Male			
Crimp connection 	8	1 - 8	COM	① HC-COM-Q08-I-CT...	1079547	1079548	1	 Dimensional drawing: female	
Crimp connection 	4 / 2	1 - 4	COM	② HC-COM-Q4/2-I-CT...	1079556	1079555	1	 Dimensional drawing: male	
Turned crimp contacts CK 1,6 Silver-plated 			Cross section mm ² / AWG 0.14 - 0.37 / 26 - 22 0.5 - 0.5 / 20 0.75 - 0.75 / 18 0.75 - 1 / 18 1.5 - 1.5 / 16 2.5 - 2.5 / 14	CK1,6-ED-0,37... AG CK1,6-ED-0,50... AG CK1,6-ED-0,75... AG CK1,6-ED-1,00... AG CK1,6-ED-1,50... AG CK1,6-ED-2,50... AG	1663394 1663404 1663417 1663420 1663433 1663446	1663336 1663349 1663352 1663365 1663378 1663381	100 100 100 100 100 100		
Turned crimp contacts CK 2,5 Silver-plated 			Cross section mm ² / AWG 0.5 - 0.5 / 20 0.75 - 0.75 / 18 0.75 - 1 / 18 1.5 - 1.5 / 16 2.5 - 2.5 / 14 4 - 4 / 12	CK2,5-ED-0,50... AG CK2,5-ED-0,75... AG CK2,5-ED-1,00... AG CK2,5-ED-1,50... AG CK2,5-ED-2,50... AG CK2,5-ED-4,00... AG	1663640 1663653 1663666 1663679 1663682 1663705	1663572 1663585 1663598 1663608 1663611 1663637	100 100 100 100 100 100		
Turned crimp contacts CK 4,0 Silver-plated 			Cross section mm ² / AWG 1.5 - 1.5 / 16 2.5 - 2.5 / 14 4 - 4 / 12 6 - 6 / 10	CK4,0-ED-1,50... AG CK4,0-ED-2,50... AG CK4,0-ED-4,00... AG CK4,0-ED-6,00... AG	1663271 1663284 1663297 1663307	1663239 1663242 1663255 1663268	25 25 25 25		

	a	b	c	d
① Female	45		48.05	
① Male				
② Female	42		48	
② Male				

Accessories



Dummy sockets
From page 657



Crimping tools
From page 670



Crimp contacts, gold-plated
From page 666

Heavy-duty connectors

HEAVYCON Compact – housings

Compact series, plastic housings









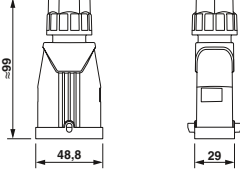

new

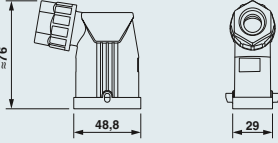

Technical data

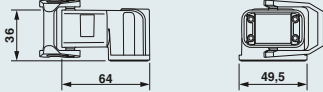
General data	
Housing material	PC
Lock material	PA
Sealing material	NBR
IP degree of protection (when plugged in)	IP65 / IP66
Ambient temperature (operation)	-40°C ... 125°C

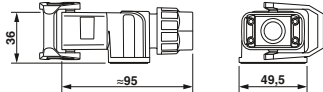
Ordering data

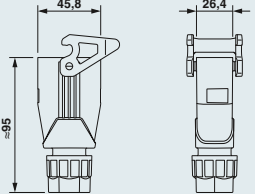
Description	Thread	Type	Order No.	Pcs./Pkt.	Dimensions
Sleeve housing Height: 84 mm 	1x M25	HC-COM-HHFS-1TGM25-PL-BK	1012520	1	
Sleeve housing Height: 84 mm 	1x M25	HC-COM-HHFS-1SGM25-PL-BK	1012581	1	
Panel mounting base Height: 18.5 mm 		HC-COM-BWS-PL-BK	1012538	1	
Panel mounting base Height: 41.7 mm 		HC-COM-BAWS-PL-BK	1012433	1	
Box mounting base Height: 68 mm 	1x M25	HC-COM-SHOWS-1SGM25-PL-BK	1079393	1	
Coupling housing Height: 68 mm 	1x M25	HC-COM-CHWS-1TGM25-PL-BK	1012521	1	

Notes:

For further accessories, see from page 654

Accessories



Replacement seals
phoenixcontact.net/products



Replacement latches
phoenixcontact.net/products

new











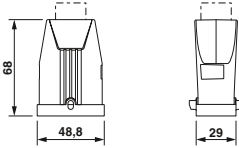

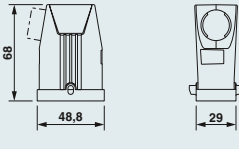
Compact series, metal housings

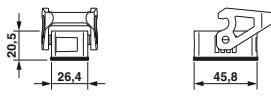
Technical data

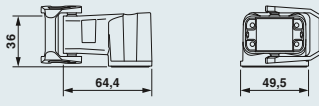
General data	
Housing material	Die-cast aluminum, salt water resistant
Lock material	PA
Sealing material	NBR
IP degree of protection (when plugged in)	IP65 / IP66
Ambient temperature (operation)	-40°C ... 125°C

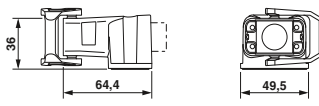
Ordering data

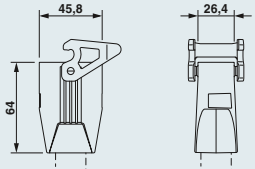
Description	Thread	Type	Order No.	Pcs./Pkt.	Dimensions
Sleeve housing Height: 68 mm 	1x M25	HC-COM-HHFS-1TTM25-EL-AL	1078590	1	
Sleeve housing Height: 68 mm 	1x M25	HC-COM-HHFS-1STM25-EL-AL	1078592	1	
Panel mounting base Height: 19.8 mm 		HC-COM-BWS-EL-AL	1078594	1	
Panel mounting base Height: 41.7 mm 		HC-COM-BAWS-EL-AL	1078593	1	
Box mounting base Height: 68 mm 	1x M25	HC-COM-SHOWS-1STM25-EL-AL	1078596	1	
Coupling housing Height: 68 mm 	1x M25	HC-COM-CHWS-1TTM25-EL-AL	1078595	1	

Notes:

For further accessories, see from page 654

Accessories



Cable glands
From page 686



Replacement seals
phoenixcontact.net/products



Replacement latches
phoenixcontact.net/products

Heavy-duty connectors

HEAVYCON accessories

Protective covers for sleeve housings of the D7 and B series

- For sleeve housing without locking latch
- With lanyard
- With seal



Protective cover with single locking latch

Technical data

General data	
Material, protective cover	PA
Degree of protection	IP66
Ambient temperature (operation)	[°C] -20 ... 100

Plastic, black	Metal
PA	Al
IP66	IP66
-20 ... 100	-40 ... 125

Ordering data

Description	
-------------	--

Order No.	Pcs./Pkt.	Order No.	Pcs./Pkt.
Plastic, black		Metal	
1419274	1		
1419275	1		
1414634	10	1644546	10
1414635	10	1584512	10
1414636	10	1584525	10
1414637	10	1584538	10



Protective cover with double locking latch

Technical data

Plastic, black	Metal
PA	Al
IP66	IP66
-20 ... 100	-40 ... 125

Ordering data

Order No.	Pcs./Pkt.	Order No.	Pcs./Pkt.
Plastic, black		Metal	
1414638	10	1584541	10
1414639	10	1584554	10
1414640	10	1584567	10

Protective covers for sleeve housings B series

- For sleeve housing with locking latch
- With lanyard
- With seal



Protective cover without double locking latch

Technical data

General data	
Material, protective cover	PA
Degree of protection	IP66
Ambient temperature (operation)	[°C] -20 ... 100

Plastic, black	Metal
PA	Al
IP66	IP66
-20 ... 100	-40 ... 125

Ordering data

Description	
-------------	--

Order No.	Pcs./Pkt.	Order No.	Pcs./Pkt.
Plastic, black		Metal	
1414631	10	1647750	10
1414632	10	1647763	10
1414633	10	1647776	10

Protective cover, for housing sizes:

B10			
B16			
B24			

Protective covers for panel mounting bases of the D7, D and B series

- For panel mounting bases, box mounting bases, and coupling housings with locking latch
- With lanyard
- Without seal



Protective cover without single locking latch



Protective cover without double locking latch

Technical data

	Plastic, black	Metal
Material, protective cover	PA	Al
Degree of protection	IP66	IP66
Ambient temperature (operation) [°C]	-20 ... 100	-40 ... 125

Technical data

	Plastic, black	Metal
Material, protective cover	PA	Al
Degree of protection	IP66	IP66
Ambient temperature (operation) [°C]	-20 ... 100	-40 ... 125

Ordering data

Description	Order No.	Pcs./Pkt.	Order No.	Pcs./Pkt.
	Plastic, black		Metal	
Protective cover , for coupling housings:				
D7, for female insert	1419270	1		
D7, for male insert	1419271	1		
D15	1424374	1		
D25	1424401	1		
D50				
B6	1414623	10	1644559	10
B10	1414625	10	1644562	10
B16	1414626	10	1644588	10
B24	1414627	10	1644601	10
B32				

Ordering data

Description	Order No.	Pcs./Pkt.	Order No.	Pcs./Pkt.
	Plastic, black		Metal	
D7, for female insert				
D7, for male insert				
D15				
D25				
D50	1424417	1		
B6				
B10	1414628	10	1644575	10
B16	1414629	10	1644591	10
B24	1414630	10	1644614	10
B32	1424850	1		

Protective covers for sleeve housings, panel mounting bases of the B series

- For sleeve housings, panel mounting bases, and coupling housings
- Color: transparent/white
- Without seal



Protective cover with clip locking

Technical data

Material, protective cover	PA
Degree of protection	IP20
Ambient temperature (operation) [°C]	0 ... 20

Ordering data

Type	Order No.	Pcs./Pkt.
HC-STA-B06-DC-PL	1421100	5
HC-STA-B10-DC-PL	1421101	5
HC-STA-B16-DC-PL	1421102	5
HC-STA-B24-DC-PL	1421103	5

Description
Protective cover , for housing sizes:
B6
B10
B16
B24

Heavy-duty connectors

HEAVYCON accessories

Coding profiles

– Can be coded in seconds, thanks to the coding profiles



HC / HC-S coding profile



HS2/MOD-K coding profile

General data	
Material	PA
Description	
Coding profiles, for contact inserts in series:	
HC-B..., HC-B...A-UT..., HC-B...A-DT...	
HC-A10..., HC-A16..., HC-BB...	
Coding profiles, for contact inserts in series:	
HC-Q12...	
HC-A3..., HC-A4...	
HC-HS2-D7-E...S	

Technical data		
PA		
Ordering data		
Type	Order No.	Pcs./Pkt.
CP-HC	1686478	10
CP-HC-S	1410916	10

Technical data		
PA		
Ordering data		
Type	Order No.	Pcs./Pkt.
HC-Q 12-COD	1409435	10
HC-MOD-K-CP	1408562	1
HC-HS 2-CP	1586280	50

Coding bolts

– Prevent up to 6 plug-in connections from being mismatched

Notes:
For assembly instructions, see phoenixcontact.net/products



Coded bolts

General data	
Material	Steel, galvanized
Description	
Coding bolt, for contact inserts in series:	
HC-B...	

Technical data		
Steel, galvanized		
Ordering data		
Type	Order No.	Pcs./Pkt.
HC-CB	1772722	10

Guide pins, sockets

– Prevent up to 16 plug-in connections from being mismatched

Notes:
For assembly instructions, see phoenixcontact.net/products



Guide pin/guide socket

Technical data		
Steel, galvanized		
Ordering data		
Type	Order No.	Pcs./Pkt.
HC-CST-MOD	1636127	10
HC-CBU-MOD	1636130	10

General data
Material
Description
Guide pin and guide socket , for coding to protect against mismatching and as a guide to prevent accidentally jamming the connector in at an angle
Guide pin
Guide socket

Dummy sockets

Prevent connectors of the same type from being mismatched. A dummy socket seals off a female contact. It is then no longer possible to insert a male contact in the same position as the dummy socket.

Notes:
For assembly instructions, see phoenixcontact.net/products



Dummy socket



Dummy socket

Technical data		
PA		
Ordering data		
Type	Order No.	Pcs./Pkt.
CK2,5-ED-BB	1584693	100

Technical data		
Copper alloy		
Ordering data		
Type	Order No.	Pcs./Pkt.
CK1,6-ED-BB	1645888	50

General data
Material
Description
Dummy sockets , for contact inserts with turned female contacts of type:
CK-2,5-ED...
CK-1,6-ED...

Heavy-duty connectors

HEAVYCON accessories

Plastic cable glands and plastic thread adapters for EVO housings of the D and EVO-M1 series

Notes:
EVO unlocking tools for EVO plastic housing; see page 659



Plastic cable gland



Plastic thread adapter

General data	
Material	PA
Ambient temperature (operation)	-40 ... 100 [°C]
Description	
	Thread type
Cable gland , for HEAVYCON EVO plastic housings of the D series and the EVO-M1 sleeve housing, for cable diameters:	
7 mm ... 13 mm	M20
9 mm ... 17 mm	M25
Thread adapter , for HEAVYCON EVO D series plastic housing	
	M25
	Pg16
	3/4 inch NPT

Technical data		
PA		
-40 ... 100		
Ordering data		
Type	Order No.	Pcs./Pkt.
HC-D-G-M20-PLRBK	1411350	1
HC-D-G-M25-PLRBK	1411351	1

Technical data		
PA		
-40 ... 125		
Ordering data		
Type	Order No.	Pcs./Pkt.
HC-D-TA-M25-PLRBK	1411352	1
HC-D-TA-PG16-PLR-BK	1411353	1
HC-D-TA-NPT-3/4-PLR-BK	1411354	1

Plastic cable glands for EVO B series housings

Notes:
EVO unlocking tools for EVO plastic housing; see page 659



Plastic cable gland



Plastic cable gland

General data	
Material	PA
Ambient temperature (operation)	-40 ... 100 [°C]
Description	
	Thread type
Cable gland , for HEAVYCON EVO B series plastic housing, for cable diameter:	
7 mm ... 13 mm	M20
9 mm ... 17 mm	M25
11 mm ... 21 mm	M32
19 mm ... 28 mm	M40
Cable gland , for B series HEAVYCON EVO plastic housing, with seal insert for cable diameter:	
without bore hole	M40
4x 10 mm	M40
5x 8.5 mm	M40
8x 6.5 mm	M40

Technical data		
PA		
-40 ... 100		
Ordering data		
Type	Order No.	Pcs./Pkt.
HC-B-G-M20-PLRBK	1407669	1
HC-B-G-M25-PLRBK	1407670	1
HC-B-G-M32-PLRBK	1407671	1
HC-B-G-M40-PLRBK	1407672	1

Technical data		
PA		
-30 ... 100		
Ordering data		
Type	Order No.	Pcs./Pkt.
HC-B-GM0-M40-PLTBK	1414643	1
HC-B-GM4X10-M40-PLTBK	1414644	1
HC-B-GM5X8,5-M40-PLTBK	1414645	1
HC-B-GM8X6,5-M40-PLTBK	1414646	1

Plastic cable glands with bend protection and strain relief for B series EVO housings

Notes:
EVO unlocking tools for EVO plastic housing; see page 659



Plastic cable gland with bend protection



Plastic cable gland with strain relief

General data	
Material	PA
Ambient temperature (operation)	-40 ... 100 [°C]
Description	
	Thread type
Cable gland, for HEAVYCON EVO B series plastic housing, for cable diameter:	
6 mm ... 13 mm	M20
9 mm ... 17 mm	M25
13 mm ... 21 mm	M32

Technical data		
PA		
-40 ... 100		
Ordering data		
Type	Order No.	Pcs./Pkt.
HC-B-GB-M20-PLRBK	1414660	1
HC-B-GB-M25-PLRBK	1414661	1
HC-B-GB-M32-PLRBK	1414662	1

Technical data		
PA		
-40 ... 100		
Ordering data		
Type	Order No.	Pcs./Pkt.
HC-B-GTRS-M20-PLRBK	1414651	1
HC-B-GTRS-M25-PLRBK	1414652	1
HC-B-GTRS-M32-PLRBK	1414654	1

Plastic thread adapters for B series EVO housings and EVO unlocking tools tool

Notes:
For further conduit adapters, visit phoenixcontact.net/products
For protective hoses for corrugated pipe adapters, see Catalog 3



Plastic thread adapter



EVO unlocking tools

General data	
Material	PA
Ambient temperature (operation)	-40 ... 100 [°C]
Description	
	Thread type
Thread adapter, for B series HEAVYCON EVO plastic housing	
M20	M20
M25	M25
M32	M32
M40	M40
Pg13.5	Pg13.5
Pg16	Pg16
Pg21	Pg21
Water pump pliers, with groove joint, gripping surfaces with dual notching, acc. to VDE ISO 8976, size: 240 mm	

Technical data		
PA		
-40 ... 100		
Ordering data		
Type	Order No.	Pcs./Pkt.
HC-B-TA-M20-PLR-BK	1414243	1
HC-B-TA-M25-PLR-BK	1414244	1
HC-B-TA-M32-PLR-BK	1414245	1
HC-B-TA-M40-PLR-BK	1414246	1
HC-B-TA-PG13-PLR-BK	1414247	1
HC-B-TA-PG16-PLR-BK	1414248	1
HC-B-TA-PG21-PLR-BK	1414249	1

Technical data		
-		
- ... -		
Ordering data		
Type	Order No.	Pcs./Pkt.
UNIFOX-WP	1212365	1

Heavy-duty connectors

HEAVYCON accessories

Metal cable glands for EVO B series housings



Metal cable gland for EMC applications



Metal cable gland for multiple cables

General data		Technical data			Technical data		
Material		Die-cast aluminum, corrosion-resistant			Die-cast aluminum, corrosion-resistant		
Ambient temperature (operation)	[°C]	-40 ... 125			-30 ... 100		
Description		Ordering data			Ordering data		
	Thread type	Type	Order No.	Pcs./Pkt.	Type	Order No.	Pcs./Pkt.
Cable gland, for HEAVYCON EVO B series metal housing, for EMC applications, for cable diameter:							
9 mm ... 13 mm	M20	HC-B-G-M20-EC-AL	1411439	1			
11 mm ... 16 mm	M25	HC-B-G-M25-EC-AL	1411446	1			
14 mm ... 21 mm	M32	HC-B-G-M32-EC-AL	1411440	1			
19 mm ... 27 mm	M40	HC-B-G-M40-EC-AL	1411441	1			
Cable gland, for HEAVYCON EVO metal housing, for higher strain relief, with NBR seal, for cable diameter:							
without bore hole	M40				HC-B-GM0-M40-ET-AL	1414647	1
4x 10 mm	M40				HC-B-GM4X10-M40-ET-AL	1414648	1
5x 8.5 mm	M40				HC-B-GM5X8,5-M40-ET-AL	1414649	1
8x 6.5 mm	M40				HC-B-GM8X6,5-M40-ET-AL	1414650	1

Metal cable glands with bend protection and strain relief for B series EVO housings



Metal cable gland with bend protection



Metal cable gland with strain relief

General data		Technical data			Technical data		
Material		-			-		
Ambient temperature (operation)	[°C]	-40 ... 100			-40 ... 100		
Description		Ordering data			Ordering data		
	Thread type	Type	Order No.	Pcs./Pkt.	Type	Order No.	Pcs./Pkt.
Cable gland, for B series HEAVYCON EVO metal housing, for cable diameter:							
6 mm ... 13 mm	M20	HC-B-GB-M20-ER-AL	1414663	1	HC-B-GTRS-M20-ER-AL	1414656	1
9 mm ... 17 mm	M25	HC-B-GB-M25-ER-AL	1414664	1	HC-B-GTRS-M25-ER-AL	1414657	1
13 mm ... 21 mm	M32	HC-B-GB-M32-ER-AL	1414665	1	HC-B-GTRS-M32-ER-AL	1414658	1
16 mm ... 28 mm	M40	HC-B-GB-M40-ER-AL	1414666	1	HC-B-GTRS-M40-ER-AL	1414659	1

**Metal thread adapter
for B series EVO housings**



Metal thread adapter

Technical data

General data	
Material	Die-cast aluminum, corrosion-resistant
Ambient temperature (operation)	-40 ... 125 [°C]

Ordering data

Description	Thread type	Type	Order No.	Pcs./Pkt.
Thread adapter, for B series HEAVYCON EVO metal housings				
	M20	HC-B-TA-M20-ER-AL	1414256	1
	M25	HC-B-TA-M25-ER-AL	1414257	1
	M32	HC-B-TA-M32-ER-AL	1414258	1
	M40	HC-B-TA-M40-ER-AL	1414259	1
	Pg13.5	HC-B-TA-PG13-ER-AL	1414260	1
	Pg16	HC-B-TA-PG16-ER-AL	1414261	1
	Pg21	HC-B-TA-PG21-ER-AL	1414262	1
	Pg29	HC-B-TA-PG29-ER-AL	1414263	1
	1/2-inch NPT	HC-B-TA-NPT-1/2-ER-AL	1414264	1
	3/4 inch NPT	HC-B-TA-NPT-3/4-ER-AL	1414265	1
	1/1-inch NPT	HC-B-TA-NPT-1/1-ER-AL	1414266	1
	1 1/4 in. NPT	HC-B-TA-NPT-1 1/4-ER-AL	1414267	1

Heavy-duty connectors

HEAVYCON accessories

PE screws, PE multipliers

If several PE conductors are led via one contact insert, additional PE connections are required. This is done using an additional PE screw or the PE multiplier.



PE screw



PE multiplier

		Technical data			Technical data		
General data							
Material		Steel, galvanized			Brass, nickel-plated		
Connection cross section [mm ²]		-			0.5 ... 2.5		
Connection cross section AWG		-			20 ... 14		
		Ordering data			Ordering data		
Description		Type	Order No.	Pcs./Pkt.	Type	Order No.	Pcs./Pkt.
PE screw , for contact inserts in series:							
HC-B..., HC-BB..., HC-DD..., HC-D40..., HC-D64...		HC-B-PES	1604997	10			
HC-HS 6...		HC-HS-PES	1586219	10			
PE screw , for contact inserts in series:							
HC-A..., HC-D15..., HC-D25...		HC-A-PES	1584868	10			
PE multiplier , with 3 PE connections, for contact inserts in series:							
HC-B..., HC-BB..., HC-DD..., HC-D40..., HC-D64...					HC-B-3PE	1644326	1

Strain relief clamps

Cable trees with crimp contacts must not put a strain on the engaged contacts with their weight.

The use of strain relief clamps eliminates this type of strain.



Lateral cable outlet



Straight cable outlet

		Technical data			Technical data		
General data							
Material		Steel, galvanized			Steel, galvanized		
		Ordering data			Ordering data		
Description		Type	Order No.	Pcs./Pkt.	Type	Order No.	Pcs./Pkt.
Strain relief clamps , clamping area of 9 - 19 mm, for contact inserts in series:							
HC-B..., HC-BB..., HC-D40..., HC-D64..., HC-DD..., HC-HV...		HC-B-ZS	1685330	10	HC-B-ZG	1685327	10

Replacement bolts and sealing screws



Replacement bolt



Sealing screw

		Technical data			Technical data		
General data							
Material		Steel, galvanized			Steel, galvanized		
		Ordering data			Ordering data		
Description		Type	Order No.	Pcs./Pkt.	Type	Order No.	Pcs./Pkt.
Replacement bolt , steel, for HEAVYCON HC-B...TFL... sleeve housing (not EMC housing) in size: B48 M3 sealing screw , IP67, for HEAVYCON housing in size: D7		HC-B 48-LB ERSBOLZ	1636114	10	HC-D 7-DS-IP65	1686229	100

Docking frames

Docking frames ensure that male and female inserts are located in insert systems and contact is made reliably.

Notes:
Due to the floating frame, the mounting panel must be grounded.



Docking frames

		Technical data		
General data				
Material		Stainless steel		
Insertion/withdrawal cycles		≥ 500		
Ambient temperature (operation) [°C]		-40 ... 125		
		Ordering data		
Description		Type	Order No.	Pcs./Pkt.
Docking frame , with 4 flat headed screws with shoulder, for contact inserts in series: B6, DD24, BB10, K, M B10, DD42, BB18, K, M B16, D40, DD72, BB32, K, M B24, D64, DD108, BB46, K, M		HC-B 6-ANDOCK HC-B 10-ANDOCK HC-B 16-ANDOCK HC-B 24-ANDOCK	1586112 1586125 1586138 1586141	2 2 2 2

Heavy-duty connectors

HEAVYCON accessories

Cover plates

For sealing unused openings in control cabinet manufacturing.



Cover plate,
height: 3.5 mm



Cover plate,
height: 7 mm

		Technical data			Technical data		
General data							
Material		PA			PA		
Color		gray			gray		
Flammability rating in accordance with UL 94		HB			HB		
Ambient temperature (operation)	[°C]	-20 ... 100			-20 ... 100		
		Ordering data			Ordering data		
Description		Type	Order No.	Pcs./Pkt.	Type	Order No.	Pcs./Pkt.
Cover plate , for a panel cutout in size:							
B6 (cutout: 35 mm x 52 mm)		HC-B 6-AP-GY	1660368	10			
B10 (cutout: 35 mm x 65 mm)		HC-B 10-AP-GY	1660371	10			
B16 (cutout: 35 mm x 86 mm)		HC-B 16-AP-GY	1660384	10	HC-B 16-APV-GY	1661121	10
B24 (cutout: 35 mm x 113 mm)		HC-B 24-AP-GY	1660397	10	HC-B 24-APV-GY	1661037	10
D15 (cutout: 24 mm x 58 mm)		HC-D 15-AP-GY	1660342	10			
D25 (cutout: 24 mm x 74 mm)		HC-D 25-AP-GY	1660355	10			

Adapter plates

For changing panel cutouts to different size.



Adapter plate



Adapter plate

		Technical data			Technical data		
General data							
Material		PA			PA		
Color		gray			gray		
Flammability rating in accordance with UL 94		HB			HB		
Ambient temperature (operation)	[°C]	-20 ... 100			-20 ... 100		
		Ordering data			Ordering data		
Description		Type	Order No.	Pcs./Pkt.	Type	Order No.	Pcs./Pkt.
Adapter plate , for reduction from a B24 panel cutout to:							
3 x D7 (cutout: 21.5 mm x 21.5 mm)		HC-B 24-ADP-3D 7-GY	1661448	10			
Adapter plate , for reduction from a B24 panel cutout to:							
3 x circular connector cutouts (Ø 21 mm)					HC-B 24-ADP-3RST-GY	1662175	10

**D-SUB adapter plates,
D series**

For installing D-SUB connectors in HEAVYCON D series housing.

Notes:
Order D-SUB connectors separately
D-SUB assembly in the adapter plate: front mounting
For D-SUB insert matrix see page 446



**Adapter plate
for a D-SUB connector**

General data	
Material	PA
Color	gray
Ambient temperature (operation)	-20 ... 100 [°C]

Technical data

Description	
D-SUB adapter plate, for equipping HC-D15... housings with one D-SUB connector, D-SUB type:	
D-SUB 09	HC-D 15-ADP/1 DSUB 9
D-SUB 15	HC-D 15-ADP/1 DSUB 15
D-SUB 25	HC-D 15-ADP/1 DSUB 25

Ordering data

Type	Order No.	Pcs./Pkt.
HC-D 15-ADP/1 DSUB 9	1661312	2
HC-D 15-ADP/1 DSUB 15	1775253	2
HC-D 15-ADP/1 DSUB 25	1775266	2

**D-SUB adapter plates,
B series**

For installing D-SUB connectors in HEAVYCON B series housing.

Notes:
Order D-SUB connectors separately
D-SUB assembly in the adapter plate: front mounting
For D-SUB insert matrix see page 446



**Adapter plate
for a D-SUB connector**



**Adapter plate
for two D-SUB connectors**

General data	
Material	PA
Color	gray
Flammability rating in accordance with UL 94	HB
Ambient temperature (operation)	-20 ... 100 [°C]

Technical data

Technical data

Description	
D-SUB adapter plate, for mounting HEAVYCON housings with D-SUB connector, for housing size / D-SUB type:	
B6 / D-SUB 09	HC-B 6-ADP/1 DSUB 9
B6 / D-SUB 15	HC-B 6-ADP/1 DSUB 15
B10 / D-SUB 25	HC-B 10-ADP/1 DSUB 25
B16 / D-SUB 37	HC-B 16-ADP/1 DSUB 37
B16 / D-SUB 50	HC-B 16-ADP/1 DSUB 50

Ordering data

Ordering data

Type	Order No.	Pcs./Pkt.
HC-B 6-ADP/1 DSUB 9	1775457	2
HC-B 6-ADP/1 DSUB 15	1775473	2
HC-B 10-ADP/1 DSUB 25	1775499	2
HC-B 16-ADP/1 DSUB 37	1775512	2
HC-B 16-ADP/1 DSUB 50	1775538	2

Type	Order No.	Pcs./Pkt.
HC-B 6-ADP/2 DSUB 9	1775460	2
HC-B 6-ADP/2 DSUB 15	1775486	2
HC-B 10-ADP/2 DSUB 25	1775509	2
HC-B 16-ADP/2 DSUB 37	1775525	2
HC-B 16-ADP/2 DSUB 50	1775541	2

Heavy-duty connectors

HEAVYCON accessories

Crimp contacts

Crimp machines for turned/rolled contacts on request.

Notes:
For voltages less than 5 V and currents less than 5 mA, gold-plated contacts are recommended.



Ø 1.6 mm, turned crimp contacts



Ø 2.5 mm, turned crimp contacts

ERC

Technical data

Material data	Hard silver-plated	Hard gold-plated
Contact material	Copper alloy	Copper alloy
Stripping length of the individual wire	8 mm	8 mm
Insertion/withdrawal cycles	≥ 500	≥ 500
Ambient temperature (operation)	-40°C ... 125°C	-40°C ... 125°C

Ordering data

Description	Type	Order No.	Pcs./Pkt.
Turned female contacts , silver-plated, for wire cross section: 0.14 mm ² ... 0.37 mm ² / AWG 26 ... 22 0.50 mm ² / AWG 20 0.75 mm ² / AWG 18 0.75 mm ² ... 1.00 mm ² / AWG 18 1.50 mm ² / AWG 16 2.50 mm ² / AWG 14 3.00 mm ² / AWG 12 4.00 mm ² / AWG 12 6.00 mm ² / AWG 10 10 mm ² /AWG 8	CK1,6-ED-0,37BU AG CK1,6-ED-0,50BU AG CK1,6-ED-0,75BU AG CK1,6-ED-1,00BU AG CK1,6-ED-1,50BU AG CK1,6-ED-2,50BU AG	1663394 1663404 1663417 1663420 1663433 1663446	100 100 100 100 100 100
Turned male contacts , silver-plated, for wire cross section: 0.14 mm ² ... 0.37 mm ² / AWG 26 ... 22 0.50 mm ² / AWG 20 0.75 mm ² / AWG 18 0.75 mm ² ... 1.00 mm ² / AWG 18 1.50 mm ² / AWG 16 2.50 mm ² / AWG 14 3.00 mm ² / AWG 12 4.00 mm ² / AWG 12 6.00 mm ² / AWG 10 10 mm ² /AWG 8	CK1,6-ED-0,37ST AG CK1,6-ED-0,50ST AG CK1,6-ED-0,75ST AG CK1,6-ED-1,00ST AG CK1,6-ED-1,50ST AG CK1,6-ED-2,50ST AG	1663336 1663349 1663352 1663365 1663378 1663381	100 100 100 100 100 100
Turned female contacts , gold-plated, for wire cross section: 0.14 mm ² ... 0.37 mm ² / AWG 26 ... 22 0.50 mm ² / AWG 20 0.75 mm ² / AWG 18 0.75 mm ² ... 1.00 mm ² / AWG 18 1.50 mm ² / AWG 16 2.50 mm ² / AWG 14 4.00 mm ² / AWG 12	CK1,6-ED-0,37BU AU CK1,6-ED-0,50BU AU CK1,6-ED-0,75BU AU CK1,6-ED-1,00BU AU CK1,6-ED-1,50BU AU CK1,6-ED-2,50BU AU	1674969 1674480 1672440 1674943 1674930 1674985	100 100 100 100 100 100
Turned male contacts , gold-plated, for wire cross section: 0.14 mm ² ... 0.37 mm ² / AWG 26 ... 22 0.50 mm ² / AWG 20 0.75 mm ² / AWG 18 0.75 mm ² ... 1.00 mm ² / AWG 18 1.50 mm ² / AWG 16 2.50 mm ² / AWG 14 4.00 mm ² / AWG 12	CK1,6-ED-0,37ST AU CK1,6-ED-0,50ST AU CK1,6-ED-0,75ST AU CK1,6-ED-1,00ST AU CK1,6-ED-1,50ST AU CK1,6-ED-2,50ST AU	1674901 1672453 1674914 1674888 1674875 1674927	100 100 100 100 100 100
Turned switch contacts , (male 2 mm lagging), for HC-HV-..., silver-plated, for wire cross section: 1.00 mm ² / AWG 18 1.50 mm ² / AWG 16 2.50 mm ² / AWG 14			
Punched-rolled female contacts , silver-plated, for wire cross section: 0.34 mm ² ... 1.00 mm ² / AWG 22 ... 18 1.50 mm ² ... 2.50 mm ² / AWG 16 ... 14			
Punched-rolled male contacts , silver-plated, for wire cross section: 0.34 mm ² ... 1.00 mm ² / AWG 22 ... 18 1.50 mm ² ... 2.50 mm ² / AWG 16 ... 14			

ERC

Technical data

Material data	Hard silver-plated	Hard gold-plated
Contact material	Copper alloy	Copper alloy
Stripping length of the individual wire	7.5 mm (9.5 mm at HC-M-HV...)	7.5 mm (9.5 mm at HC-M-HV...)
Insertion/withdrawal cycles	≥ 500	≥ 500
Ambient temperature (operation)	-40°C ... 125°C	-40°C ... 125°C

Ordering data

Description	Type	Order No.	Pcs./Pkt.
Turned female contacts , silver-plated, for wire cross section: 0.14 mm ² ... 0.37 mm ² / AWG 26 ... 22 0.50 mm ² / AWG 20 0.75 mm ² / AWG 18 0.75 mm ² ... 1.00 mm ² / AWG 18 1.50 mm ² / AWG 16 2.50 mm ² / AWG 14 3.00 mm ² / AWG 12 4.00 mm ² / AWG 12 6.00 mm ² / AWG 10 10 mm ² /AWG 8	CK2,5-ED-0,50BU AG CK2,5-ED-0,75BU AG CK2,5-ED-1,00BU AG CK2,5-ED-1,50BU AG CK2,5-ED-2,50BU AG CK2,5-ED-3,00BU AG CK2,5-ED-4,00BU AG	1663640 1663653 1663666 1663679 1663682 1663695 1663705	100 100 100 100 100 100 100
Turned male contacts , silver-plated, for wire cross section: 0.14 mm ² ... 0.37 mm ² / AWG 26 ... 22 0.50 mm ² / AWG 20 0.75 mm ² / AWG 18 0.75 mm ² ... 1.00 mm ² / AWG 18 1.50 mm ² / AWG 16 2.50 mm ² / AWG 14 3.00 mm ² / AWG 12 4.00 mm ² / AWG 12 6.00 mm ² / AWG 10 10 mm ² /AWG 8	CK2,5-ED-0,50ST AG CK2,5-ED-0,75ST AG CK2,5-ED-1,00ST AG CK2,5-ED-1,50ST AG CK2,5-ED-2,50ST AG CK2,5-ED-3,00ST AG CK2,5-ED-4,00ST AG	1663572 1663585 1663598 1663608 1663611 1663624 1663637	100 100 100 100 100 100 100
Turned female contacts , gold-plated, for wire cross section: 0.14 mm ² ... 0.37 mm ² / AWG 26 ... 22 0.50 mm ² / AWG 20 0.75 mm ² / AWG 18 0.75 mm ² ... 1.00 mm ² / AWG 18 1.50 mm ² / AWG 16 2.50 mm ² / AWG 14 4.00 mm ² / AWG 12	CK2,5-ED-0,37BU AU CK2,5-ED-0,50BU AU CK2,5-ED-1,00BU AU CK2,5-ED-1,50BU AU CK2,5-ED-2,50BU AU CK2,5-ED-4,00BU AU	1585647 1674859 1674833 1674820 1674862 1674846	100 100 100 100 100 100
Turned male contacts , gold-plated, for wire cross section: 0.14 mm ² ... 0.37 mm ² / AWG 26 ... 22 0.50 mm ² / AWG 20 0.75 mm ² / AWG 18 0.75 mm ² ... 1.00 mm ² / AWG 18 1.50 mm ² / AWG 16 2.50 mm ² / AWG 14 4.00 mm ² / AWG 12	CK2,5-ED-0,37ST AU CK2,5-ED-0,50ST AU CK2,5-ED-1,00ST AU CK2,5-ED-1,50ST AU CK2,5-ED-2,50ST AU CK2,5-ED-4,00ST AU	1585663 1674804 1674781 1674778 1674817 1674794	100 100 100 100 100 100
Turned switch contacts , (male 2 mm lagging), for HC-HV-..., silver-plated, for wire cross section: 1.00 mm ² / AWG 18 1.50 mm ² / AWG 16 2.50 mm ² / AWG 14	CK2,5-ED-1,00ST-S AG CK2,5-ED-1,50ST-S AG CK2,5-ED-2,50ST-S AG	1663857 1663860 1663873	100 100 100

Heavy-duty connectors

HEAVYCON accessories

Type J iron and constantan crimp contacts

In hot runner injection molding machines, temperatures are often measured using iron or constantan thermocouples. Iron or constantan elements are used for temperatures up to around 450 °C.

Temperature measurements using iron or constantan elements on the brass crimp contact of a connector cause thermoelectric voltages that falsify the measuring result. The use of iron or constantan crimp contacts is therefore recommended.

Crimp contacts made from iron or constantan can be used in the A/B/BB/HV series contact inserts and in the HC-Q05..., HC-M-06..., HC-M-08..., HC-M-20-... modules.

It is possible to use mixed contact configurations (standard, thermal contacts) for the crimp contact inserts.

Notes:

For crimping pliers, assembly and removal tools, see page 670

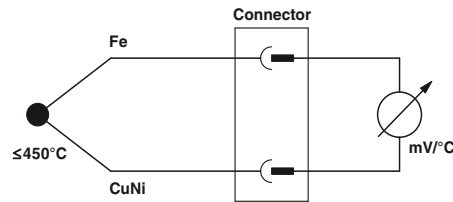

Material data	
Contact material	Iron
Contact surface material	Hard gold-plated
Stripping length of the individual wire	7.5 mm (9.5 mm at HC-M-HV...)
Insertion/withdrawal cycles	≥ 500
Temperature data	
Ambient temperature (operation)	-40°C ... 125°C

Description	
Turned female contacts, 0.5 mm²	
Iron (Fe), Au surface	1585773
Constants (CuNi), uncoated	1585757
Turned male contacts, 0.5 mm²	
Iron (Fe), Au surface	1585760
Constants (CuNi), uncoated	1585744



Turned crimp contacts, for CK 2,5 crimp contacts: HC-A..., HC-B..., HC-BB..., HC-Q05..., HC-M...

Technical data	
Iron	Copper-nickel (constants)
Hard gold-plated	-
7.5 mm (9.5 mm at HC-M-HV...)	7.5 mm (9.5 mm at HC-M-HV...)
≥ 500	≥ 500
-40°C ... 125°C	

Ordering data		
Type	Order No.	Pcs./Pkt.
CK2,5-ED-0,5BU FE	1585773	25
CK2,5-ED-0,5BU CUNI	1585757	25
CK2,5-ED-0,5ST FE	1585760	25
CK2,5-ED-0,5ST CUNI	1585744	25

FO crimp contacts

Fiber optic crimp contacts (980/1000 µm) are suitable for coupling fiber optics (polymer optical fibers). You can use the following crimp contact carriers:

- VC-D (for turned contacts)
- HC M 12..., HC-M-17..., HC-M-03/04...
- HC-D... (for turned contacts) and
- HC-DD...

The optic fibers are polished, stripped, and then crimped.



Crimp contacts for fiber optic cables, polymer optical fibers (POF)

Material data	
Contact material	Nickel silver
Insertion/withdrawal cycles	≥ 500

Description	
Fiber optic contact POF, turned, for VC-D contact carriers	
Female	1885004
Male	1884995
Tools, for fiber optics:	
Crimping pliers	1584839
Polisher	1686122
Polishing strip	1636800
Polishing paper	1636813

Technical data	
Nickel silver	
≥ 500	

Ordering data		
Type	Order No.	Pcs./Pkt.
CK1,6-ED-BU-POF	1885004	50
CK1,6-ED-ST-POF	1884995	50
CRIMPFOX-1,6-ED-POF-N	1584839	1
POLISHER-POF	1686122	1
POLFOL 1 MIC-POF	1636800	10
POLPAP 1500-POF	1636813	10

Shield connection



The HEAVYCON D bus contact is used to connect shielded, 2-core bus conductors. The connection takes up 4 adjacent positions in the contact carrier. The overall shielding braid is also suitable as a T-coupler (two positions for the cable shield).



For crimp contact carriers of series HC-D40 / -D64 / HC-M-12

ERIC

Electrical data	
Rated voltage	60 V
Rated current	-
Transmission speed	-
Material specifications for distributor	
Contact material	Copper alloy
Contact surface material	hard-silver plated
Mechanical data	
External cable diameter	6 mm ... 9 mm
Temperature data	
Ambient temperature (operation)	-40°C ... 60°C

Technical data

Rated voltage	60 V
Rated current	-
Transmission speed	-
Material specifications for distributor	
Contact material	Copper alloy
Contact surface material	hard-silver plated
Mechanical data	
External cable diameter	6 mm ... 9 mm
Temperature data	
Ambient temperature (operation)	-40°C ... 60°C

Description	
Shield connection , for two shielded cables, incl. two loose female crimp contacts for PROFIBUS cables.	
Shield connection , for a shielded line on male contact carriers, incl. two loose crimp contacts for PROFIBUS line	
Shield connection , for shielded cables on female contact carriers, without loose crimp contacts	
For one bus line For two bus lines	
Shield connection , for shielded cables on male contact carriers, without loose crimp contacts	
For one bus line For two bus lines	
Crimping pliers	
- For turned contacts; 0.14 ... 4 mm ²	
Assembly tool	
- For contacts CK1,6-ED.../CK2,5-ED.../CK1,6-ER...	

Ordering data

Type	Order No.	Pcs./Pkt.
HC-D 4-BU-2BUS	1886139	1
HC-D 4-ST-1BUS	1886142	1
HC-D 4-1BU	1886143	1
HC-D 4-2BU	1886140	1
HC-D 4-1ST	1886144	1
HC-D 4-2ST	1886141	1
CRIMPFOX-1,6/2,5-ED-4,0	1687419	1
UNIFOX MT-CK 1.6/2.5	1089092	1

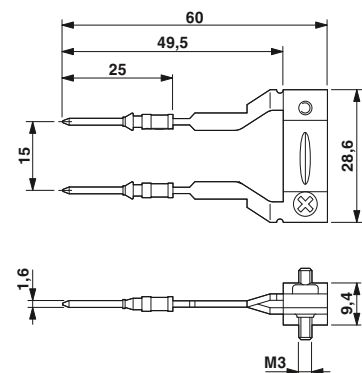

HC-D 4-...BUS

Heavy-duty connectors

HEAVYCON accessories

CRIMPFOX crimping pliers for turned contacts

- The integrated positioning tool ensures that the contacts are perfectly aligned in the die
- Marked die stations for precise processing of the relevant cross sections

Notes:
Spare dies and spare retaining springs can be found in the product area on our website at phoenixcontact.net/products.



Conductor cross section of 0.14 ... 4 mm²

Conductor cross section 6 ... 10 mm²

Application range	
Conductor	[mm ²] / AWG
Compression	

Technical data		
Conductor	0.14 ... 4 / 26 ... 12	
Compression	Square crimp	

Technical data		
Conductor	6 ... 10 / 10 ... 8	
Compression	Square crimp	

Description	
Crimping pliers , for turned male and female contacts, CK1,6-ED..., CK2,5-ED..., CK4,0-ED...	
- For turned contacts; 0.14 to 4 mm ²	
- For CK4,0-ED...6 - 10 mm ² turned contacts	

Ordering data		
Type	Order No.	Pcs./Pkt.
CRIMPFOX-TC 4	1212113	1

Ordering data		
Type	Order No.	Pcs./Pkt.
CRIMPFOX-TC 10	1212114	1

Contact removal tool , for crimp contacts	
- For turned and rolled CK-1,6-... contacts	
- For turned CK-2,5-... contacts	
- For turned CK-4,0-... contacts	

Accessories		
Type	Order No.	Pcs./Pkt.
UNIFOX RT-CK 1.6	1072069	1
UNIFOX RT-CK 2.5	1072067	1
UNIFOX RT-CK 4.0	1072064	1

Accessories		
Type	Order No.	Pcs./Pkt.
UNIFOX RT-CK 4.0	1072064	1

CRIMPFOX universal pliers for accommodating various crimp inserts

- One of the key features of the CRIMPFOX-M crimping pliers is the way the crimp inserts can be quickly replaced without the need for tools

Notes:
For more crimping dies for ferrules, cable lugs, slip-on sleeves, turned contacts, coaxial, RJ45, and RJ11 plugs, visit phoenixcontact.net/products



Basic pliers

Application range	
Compression	

Technical data		
Application range	universal	

Description	
Basic pliers , for accommodating dies for various contact types, unlockable pressure lock, lateral entry	

Ordering data		
Type	Order No.	Pcs./Pkt.
CRIMPFOX-M	1212072	1

Die , for turned male and female contacts	
CK2,5-ED..., CK4,0-ED..., cross section 0.5 - 4 mm ²	
CK4,0-ED..., cross section 6 - 10 mm ²	

Accessories		
Type	Order No.	Pcs./Pkt.
CRIMPFOX-M TC 4/DIE	1212075	1
CRIMPFOX-M TC 10/DIE	1212076	1

CRIMPFOX crimping pliers for rolled contacts

new



Conductor cross section of 0.14 ... 2.5 mm²

Application range	
Conductor	[mm ²] / AWG
Compression	

Technical data		
0.14 ... 2.5 / 26 ... 14		
B crimp		

Description	
Crimping pliers for CK 1,6-ER... OIC rolled contacts, cross section: 0.14 ... 2.5 mm ² , unlockable pressure lock, front entry, incl. positioning tool	

Ordering data		
Type	Order No.	Pcs./Pkt.
CRIMPFOX-P CK 1.6 ER 2.5 OIC-L	1069228	1

Assembly tool	
- For contacts CK1,6-ED.../CK2,5-ED.../CK1,6-ER...	

Accessories		
UNIFOX MT-CK 1.6/2.5	1089092	1

CRIMPFOX crimping pliers for coaxial connectors

- The CRIMPFOX-CX 4,2 tool is a pair of crimping pliers for processing coaxial contacts
- The CRIMPFOX-TC MP tool is a pair of crimping pliers for processing D-SUB contacts

Notes:
Spare dies and spare retaining springs can be found in the product area on our website at phoenixcontact.net/products.



For coaxial connectors



0.08 ... 2.5 mm² conductor cross section

Application range	
Compression	

Technical data		
HEX crimp		

Description	
Crimping pliers for coaxial connectors, 1.69 mm, 3.25 mm, 4.52 mm, three marked die stations, unlockable pressure lock, lateral entry, hex crimp	

Ordering data		
Type	Order No.	Pcs./Pkt.
CRIMPFOX-CX 4,52	1212094	1

Crimping pliers, for turned contacts, universal cross section setting, up to a maximum of 2.5 mm ² , digital display with 0.01 mm increments, unlockable pressure lock, lateral entry, including positioning tool	
- For turned contacts, four-mandrel crimping	

Accessories		
HC-M4-KOAX-EWZ	1676747	1

Removal tool	
- For coax contacts HC-M-04...KOAX... - For D-SUB contacts VS-...CD...	

Technical data		
Four-mandrel crimping		

Ordering data		
Type	Order No.	Pcs./Pkt.
CRIMPFOX-TC MP	1212510	1

Accessories		
EWR	1665075	1

Heavy-duty connectors

DUPLICON stackable power distribution system



DUPLICON is a comprehensive power distribution system for 6 x 4 mm² and PE conductors (25 A / 400/690 V). The system has a minimum of components and is flexible in terms of handling. The robust metal housing with vibration-proof locking latches qualifies DUPLICON for the harshest operating conditions.

DUPLICON features IP67 degree of protection. The contact inserts have a leading PE contact. The screw connections can be assembled with standard tools. DUPLICON acts as an interface between the control cabinet and the device or actuators and drives.

With its additional connections, DUPLICON provides a broad range of possible applications:

Connection of 24 V, connection of

two-wire bus lines for AS-i or PROFIBUS, and connection to the signal network.

Thanks to the plug-in design, all cables can be conveniently assembled in the workshop and quickly connected together in the system. All connections are touch-proof in accordance with DIN VDE 0105 and meet the demands of the BGV A2 accident prevention regulations.

i Your web code: #0004

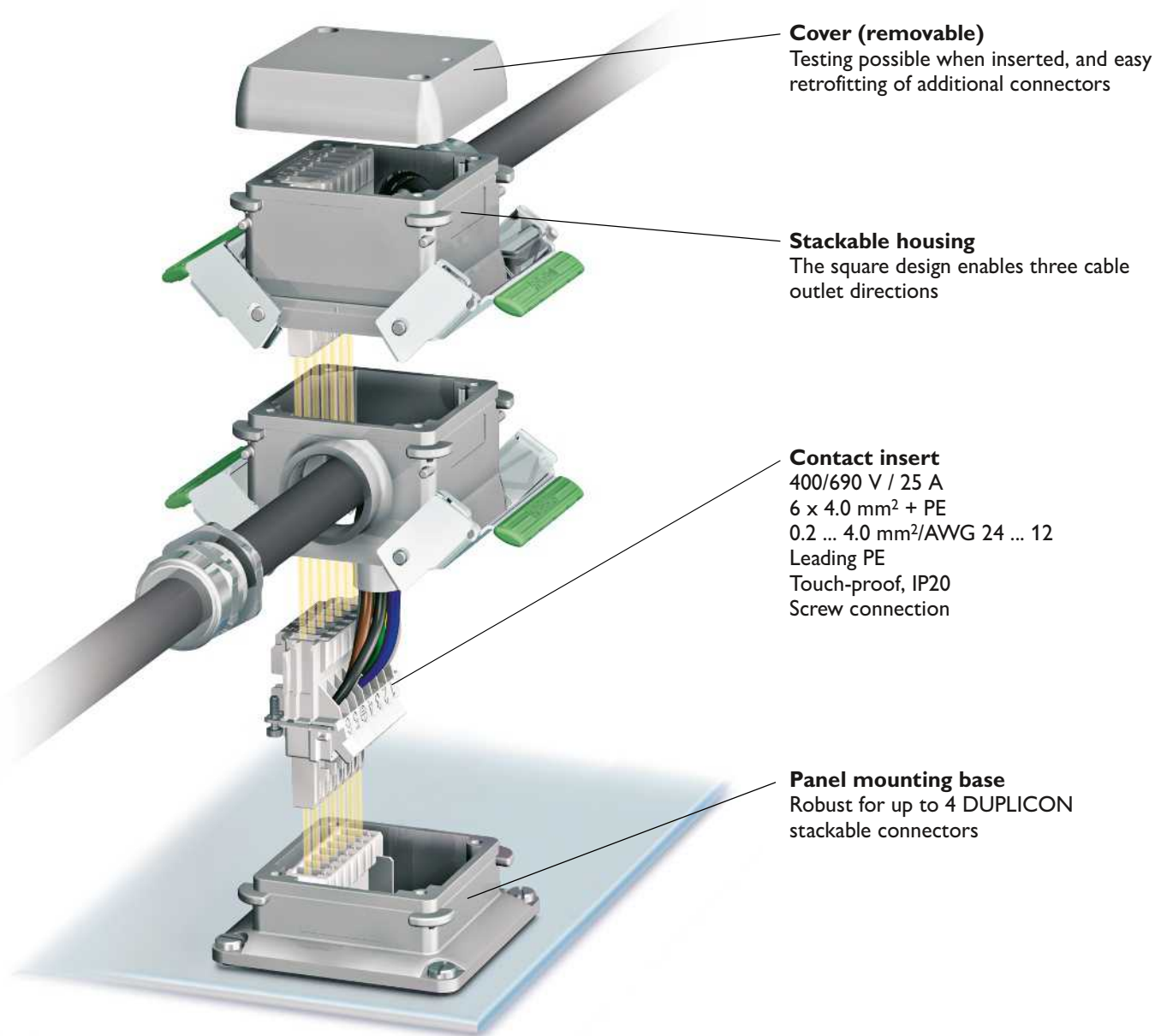

Cover (removable)

Testing possible when inserted, and easy retrofitting of additional connectors

Stackable housing

The square design enables three cable outlet directions

Contact insert

400/690 V / 25 A
6 x 4.0 mm² + PE
0.2 ... 4.0 mm²/AWG 24 ... 12
Leading PE
Touch-proof, IP20
Screw connection

Panel mounting base

Robust for up to 4 DUPLICON stackable connectors

Stationary power distribution

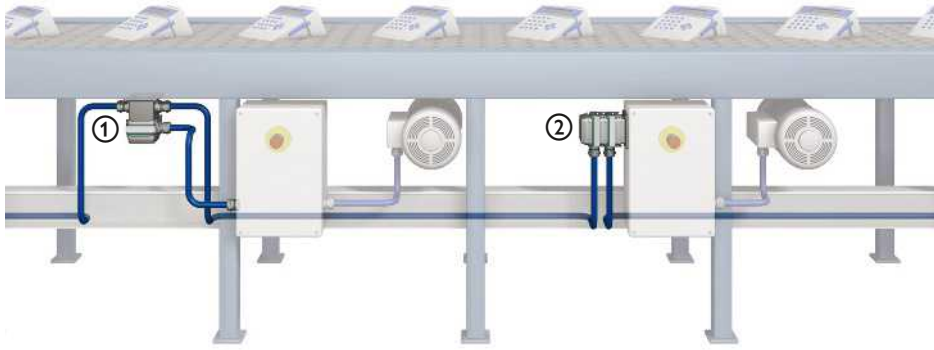

There are two DUPLICON options for stationary power distribution:

- ① Using a T-box, which is installed permanently next to the power consumer and has a plug-in cable outlet.
- ② With a stackable device connection. Direct device connection is always the best

option, but this requires design-based integration.

The main advantage is the ability to plug in the cables separately. This simplifies startup and also enables the device to be replaced without interruption during subsequent servicing

Modular power distribution

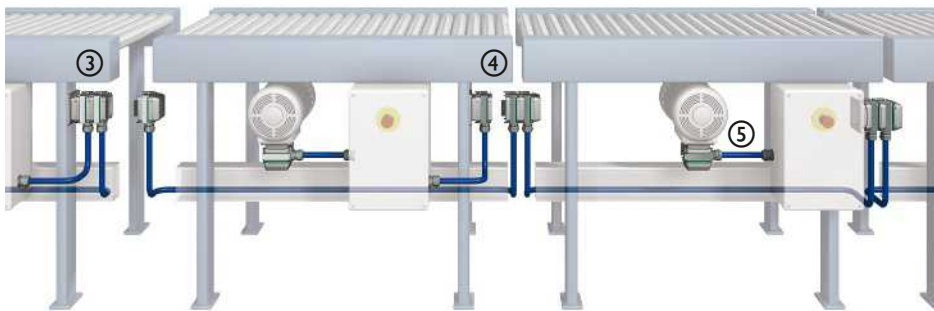

- ③ You can configure your power distribution in advance, thanks the stackable design. Plug and Play ensures fast and safe startup.
- ④ During servicing, the main power cable is disconnected from the load without causing any interruption. The system continues to run.

- ⑤ DUPLICON is also suitable for use as a motor connector. The square design enables three different cable outlet directions. The vibration-resistant locking mechanism can withstand the harshest operating conditions.

Cable routing options



With hybrid cables

In the simplest case, one cable is inserted per stackable housing. With the aid of an M25 adapter screw connection, cables with a diameter of up to 21 mm can be connected.



With separate cables

The cable glands with two drill holes allow thin power and 24 V cables to be routed separately into a stackable housing.



With opposing cables

Housings with two cable entries allow cables with larger diameters or combinations, e.g., with AS-i cables or PROFIBUS, to be routed in.

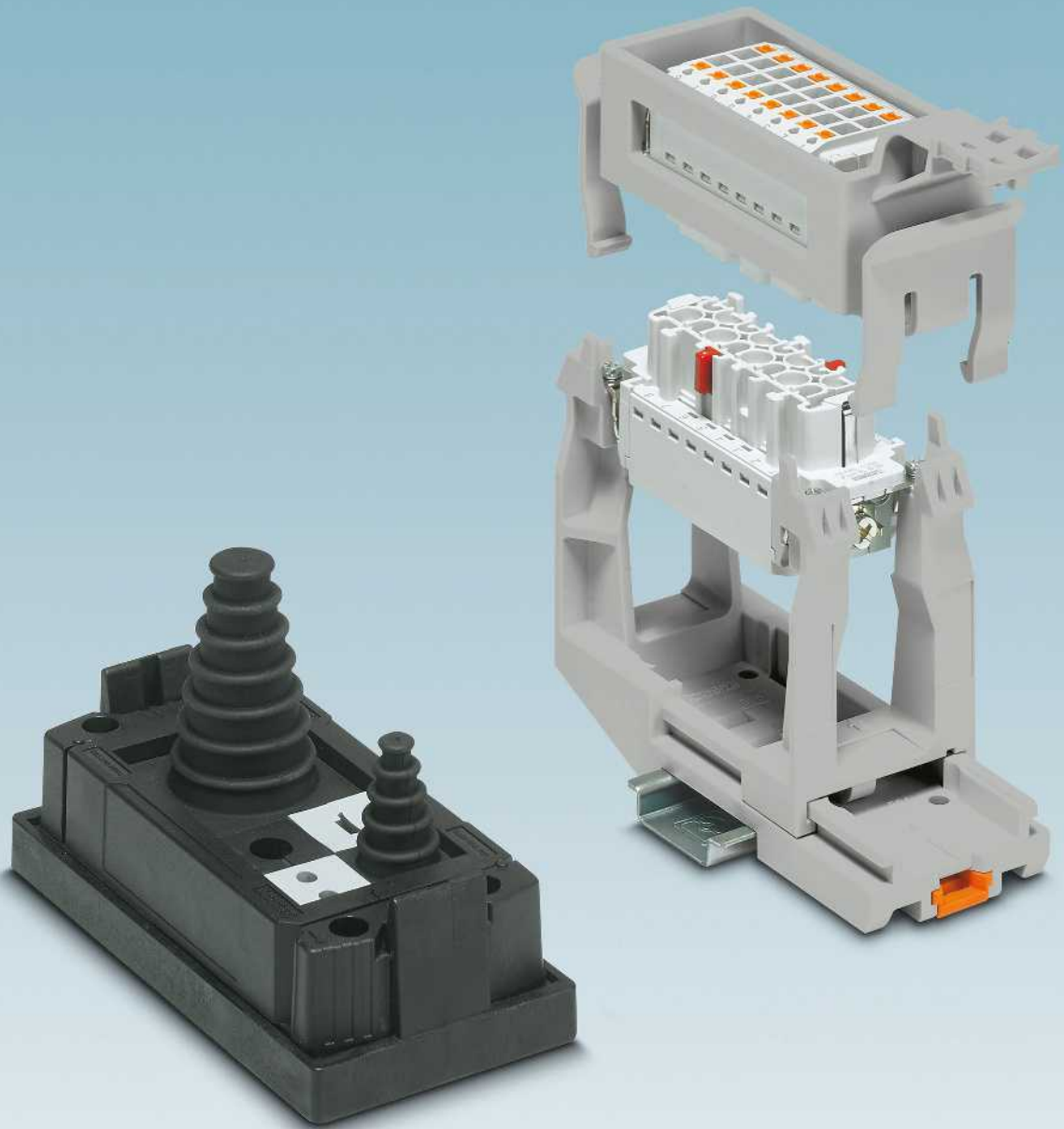

Installation and mounting material

Phoenix Contact installation and mounting material gives you virtually unlimited possibilities when it comes to laying cables into and out of the control cabinet into the field:

The CES system enables water- and dust-proof cable entry into the control cabinet. Frames with modules that can be flexibly combined or space-saving membrane plates are available for this.

Wherever cables are subjected to high tensile forces, cable glands are an excellent alternative to panel feed-through systems.

With DIN rail mounting frames from Phoenix Contact, you can implement the plug-in connection on the DIN rail. This saves entire marshalling levels in the control cabinet. The frames accommodate pre-assembled contact inserts and can be combined with HEAVYCON EVO sleeve housings.

Space-saving service interfaces simplify maintenance, service, and diagnostics on control cabinets and devices.

Marking material for cables and connectors, matching tools, and protective hoses simplify assembly and provide a clearer overview in control cabinets and systems.

i Your web code: **#0005**

Modular cable entry system	676
Multigates cable entry plates	683
DIN rail mounting frames	684
Cable glands	686
Service interfaces	708
Marking and labeling	722



- Sealing frame with integrated metal reinforcement to protect against deformation
- Only two locking elements are required (screws or latch)
- Suitable for standard panel cutouts
- Snap-on frame for simplifying on-site installation
- Sealing frame with convenient locking latch for tool-free actuation
- Marking for cable sleeve location on the underside of the frame

Notes:
For assembly instructions, see phoenixcontact.net/products
If the panel cutout width is 51 mm, HC industrial connectors and CIF DIN rail mounting frames can also be fed through the panel using the cable entry system (CES).



Sealing frame with locking latch



General data	
Material of frames	PA
Material of cable sleeves	-
Degree of protection	IP54
Flammability rating in accordance with UL 94	V0
Temperature range	-40 ... 120 [°C]

Technical data

Material of frames	PA
Material of cable sleeves	-
Degree of protection	IP54
Flammability rating in accordance with UL 94	V0
Temperature range	-40 ... 120 [°C]

Description

Sealing frame, including flat gasket, for accommodating cable sleeves, **for standard cutout:**

B10 (cutout: 35 mm x 65 mm), for up to 6 cable sleeves
 B16 (cutout: 35 mm x 86 mm), for up to 8 cable sleeves
 B24 (cutout: 35 mm x 113 mm), for up to 10 cable sleeves

Pre-assembled sealing frames with cone-shaped cable sleeves, for cables with a diameter of 2 mm ... 11 mm, **for standard cutouts:**

B16 (cutout: 36 mm x 86 mm)
 B24 (cutout: 36 mm x 113 mm)

Snap-on frame, including integrated seal for mounting panel, for accommodating sealing frames, **for standard cutouts:**

B10 (cutout: 35 mm x 65 mm)
 B16 (cutout: 35 mm x 86 mm)
 B24 (cutout: 35 mm x 113 mm)

Ordering data

Type	Order No.	Pcs./Pkt.
CES-B10-HFFS-PLBK	0801663	1
CES-B16-HFFS-PLBK	0801662	1
CES-B24-HFFS-PLBK	0801661	1

Replacement flat gasket, for sealing frame with **standard cutout:**

B10 (cutout: 35 mm x 65 mm)
 B16 (cutout: 35 mm x 86 mm)
 B24 (cutout: 35 mm x 113 mm)

Accessories

CES-B10-WRG-BK	0801725	10
CES-B16-WRG-BK	0801726	10
CES-B24-WRG-BK	0801727	10

Locking plate, metal, locks an unused snap-up frame, transport protection, **for standard cutouts:**

B10
 B16
 B24

Electrician's scissors, high cutting performance, thanks to micro-serrated cutting area, suitable for copper, aluminum (flexible), Kevlar® fibers, and plastic, two-component non-slip soft-grip handles, ergonomic design, adjustable screw joint

M4 replacement locking screw, with 3 mm Allen screw head, for sealing frame with screw locking

Bit screwdriver, with 1/4" quick-action chuck, suitable for bits in accordance with DIN 3126-C 6.3 and E 6.3/ISO 1173, magnetic

Bit screwdriver
Screw bit, hexagonal, E6.3-1/4" drive, hardened, suitable for holder in accordance with DIN 3126-F 6.3/ISO 1173, size: hex 3 x 50 mm
Screw bit, size: hex 3 x 50 mm



Sealing frame with screw locking



Sealing frame with cone-shaped cable sleeves and screw locking



Snap-on frame



Technical data
PA
-
IP54 / IP65
V0
-40 ... 120

Ordering data		
Type	Order No.	Pcs./Pkt.
CES-B10-SFFS-PLBK	0801660	1
CES-B16-SFFS-PLBK	0801659	1
CES-B24-SFFS-PLBK	0801658	1
CES-B16-8XSRC-BK	1411073	1
CES-B24-10XSRC-BK	1411074	1

Accessories		
Type	Order No.	Pcs./Pkt.
CES-B10-WRG-BK	0801725	10
CES-B16-WRG-BK	0801726	10
CES-B24-WRG-BK	0801727	10
CES-SFFS-H	0801728	10
SF-M BH	1212070	5
SF-BIT-HEX 3-50	1212647	5



Technical data
PA
NBR
IP54 / IP65
-
-40 ... 120

Ordering data		
Type	Order No.	Pcs./Pkt.
CES-B16-8XSRC-BK	1411073	1
CES-B24-10XSRC-BK	1411074	1
CES-B10-SF-PLBK	0801655	1
CES-B16-SF-PLBK	0801651	1
CES-B24-SF-PLBK	0801647	1

Accessories		
Type	Order No.	Pcs./Pkt.
CUTFOX-ES	1212621	1
CES-SFFS-H	0801728	10
SF-M BH	1212070	5
SF-BIT-HEX 3-50	1212647	5

Technical data
PA
-
IP54
V0
-20 ... 80

Ordering data		
Type	Order No.	Pcs./Pkt.
CES-B10-SF-PLBK	0801655	1
CES-B16-SF-PLBK	0801651	1
CES-B24-SF-PLBK	0801647	1
CES-B10-SFC-M-15,6	1423743	10
CES-B16-SFC-M-15,6	1423744	10
CES-B24-SFC-M-15,6	1423745	10

Accessories		
Type	Order No.	Pcs./Pkt.
CES-B10-SFC-M-15,6	1423743	10
CES-B16-SFC-M-15,6	1423744	10
CES-B24-SFC-M-15,6	1423745	10

Installation and mounting material

Modular cable entry system

Cable sleeves, rubber

Advantages:

- Resistant to oil, fuels, and grease
- Halogen-free

Notes:

The CES cable entry system was developed in accordance with DIN EN 50262 (Cable glands for electrical installations).

Assemble the cable sleeves in accordance with the enclosed assembly instructions.



Cable sleeves, small



Cable sleeves, large

Ⓡ

Ⓡ

General data			Technical data			Technical data		
Material			NBR			NBR		
Degree of protection			IP54			IP54		
Temperature range		[°C]	-40 ... 125			-40 ... 125		
Description			Ordering data			Ordering data		
	Color		Type	Order No.	Pcs./Pkt.	Type	Order No.	Pcs./Pkt.
Cone-shaped cable sleeves , IP65 in sealing frames with screw locking and cable binders, IP54 in sealing frames with locking latch. For cables with a diameter of:								
2 mm ... 11 mm	black		CES-SRC-BK	0801718	10	CES-LRC-BK	0801719	10
7 mm ... 24 mm	black							
Cable sleeves, IP54, without bore hole , can be used in sealing frames with locking latch and screw locking								
	black		CES-SRG-BK	0801670	10	CES-LRG-BK	0801671	10
Cable sleeves, small, slotted , can be used in sealing frames with locking latch and screw locking, for cable diameter of:								
1 mm ... 2 mm	black		CES-SRG-BK-2	0801635	10			
2 mm ... 3 mm	black		CES-SRG-BK-3	0801633	10			
3 mm ... 4 mm	black		CES-SRG-BK-4	0801632	10			
4 mm ... 5 mm	black		CES-SRG-BK-5	0801630	10			
5 mm ... 6 mm	black		CES-SRG-BK-6	0801628	10			
6 mm ... 7 mm	black		CES-SRG-BK-7	0801627	10			
7 mm ... 8 mm	black		CES-SRG-BK-8	0801625	10			
8 mm ... 9 mm	black		CES-SRG-BK-9	0801622	10			
9 mm ... 10 mm	black		CES-SRG-BK-10	0801620	10			
10 mm ... 11 mm	black		CES-SRG-BK-11	0801618	10			
11 mm ... 12 mm	black		CES-SRG-BK-12	0801617	10			
12 mm ... 13 mm	black		CES-SRG-BK-13	0801616	10			
13 mm ... 14 mm	black		CES-SRG-BK-14	0801615	10			
14 mm ... 15 mm	black		CES-SRG-BK-15	1410563	10			
15 mm ... 16 mm	black		CES-SRG-BK-16	1410576	10			
16 mm ... 17 mm	black		CES-SRG-BK-17	1410589	10			
Cable sleeves, large, slotted , can be used in sealing frames with locking latch and screw locking, for cable diameter of:								
14 mm ... 15 mm	black					CES-LRG-BK-15	0801619	10
15 mm ... 16 mm	black					CES-LRG-BK-16	0801621	10
16 mm ... 17 mm	black					CES-LRG-BK-17	0801624	10
17 mm ... 18 mm	black					CES-LRG-BK-18	0801626	10
18 mm ... 19 mm	black					CES-LRG-BK-19	0801629	10
19 mm ... 20 mm	black					CES-LRG-BK-20	0801631	10
20 mm ... 21 mm	black					CES-LRG-BK-21	0801634	10
21 mm ... 22 mm	black					CES-LRG-BK-22	0801637	10
22 mm ... 23 mm	black					CES-LRG-BK-23	0801638	10
23 mm ... 24 mm	black					CES-LRG-BK-24	0801639	10
24 mm ... 25 mm	black					CES-LRG-BK-25	0801640	10
25 mm ... 26 mm	black					CES-LRG-BK-26	0801643	10
26 mm ... 27 mm	black					CES-LRG-BK-27	0801644	10
27 mm ... 28 mm	black					CES-LRG-BK-28	0801646	10
28 mm ... 29 mm	black					CES-LRG-BK-29	0801648	10
29 mm ... 30 mm	black					CES-LRG-BK-30	0801650	10
30 mm ... 31 mm	black					CES-LRG-BK-31	0801653	10
31 mm ... 32 mm	black					CES-LRG-BK-32	0801654	10
32 mm ... 33 mm	black					CES-LRG-BK-33	0801656	10

Cable sleeves, rubber, special formats

Advantages:

- Resistant to oil, fuels, and grease
- Halogen-free

Notes:
The CES cable entry system was developed in accordance with DIN EN 50262 (Cable glands for electrical installations).
Assemble the cable sleeves in accordance with the enclosed assembly instructions.



Cable sleeves, small, with several bore holes



Cable sleeves, small, for AS interface cables

Ⓢ

		Technical data			Technical data		
General data							
Material		NBR		NBR			
Degree of protection		IP54		IP54			
Temperature range	[°C]	-40 ... 125		-40 ... 125			
		Ordering data			Ordering data		
Description	Color	Type	Order No.	Pcs./Pkt.	Type	Order No.	Pcs./Pkt.
Cable sleeves, with 2 bore holes, small, slotted, can be used in sealing frames with locking latch and screw locking, for cable diameter of:							
2x 2 mm ... 3 mm	black	CES-SRG-BK-2X3	1410398	10			
2x 3 mm ... 4 mm	black	CES-SRG-BK-2X4	1410408	10			
2x 4 mm ... 5 mm	black	CES-SRG-BK-2X5	0801657	10			
2x 5 mm ... 6 mm	black	CES-SRG-BK-2X6	0801664	10			
2x 6 mm ... 7 mm	black	CES-SRG-BK-2X7	1410084	10			
2x 7 mm ... 8 mm	black	CES-SRG-BK-2X8	1410097	10			
2x 8 mm ... 9 mm	black	CES-SRG-BK-2X9	1410411	10			
Cable sleeves, with 4 bore holes, small, slotted, can be used in sealing frames with locking latch and screw locking, for cable diameter of:							
4 x 2 mm ... 3 mm	black	CES-SRG-BK-4X3	0801665	10			
4 x 3 mm ... 4 mm	black	CES-SRG-BK-4X4	0801666	10			
4 x 4 mm ... 5 mm	black	CES-SRG-BK-4X5	1410107	10			
4 x 5 mm ... 6 mm	black	CES-SRG-BK-4X6	1410152	10			
Cable sleeve, IP54, slotted, for one AS-Interface cable, cable arrangement:							
L	black				CES-SRG-BK-1ASI-L	1410042	10
R	black				CES-SRG-BK-1ASI-R	0801667	10
Cable sleeve, IP54, slotted, for two AS-Interface cables, cable arrangement:							
LL	black				CES-SRG-BK-2ASI-LL	1410055	10
RR	black				CES-SRG-BK-2ASI-RR	0801668	10
LR	black				CES-SRG-BK-2ASI-LR	0801669	10

Installation and mounting material

Modular cable entry system

Cable sleeves, thermoplastic

Advantages:

- Low flammability in accordance with UL 94 V0 of thermoplastic sleeves
- Good resistance to acids and lyes

Notes:
The CES cable entry system was developed in accordance with DIN EN 50262 (Cable glands for electrical installations).
Assemble the cable sleeves in accordance with the enclosed assembly instructions.



Cable sleeves, small



Cable sleeves, large



General data				Technical data			Technical data		
Material		SEBS		SEBS		SEBS			
Degree of protection		IP54		IP54		IP54			
Flammability rating in accordance with UL 94		V0		V0		V0			
Temperature range	[°C]	-40 ... 80		-40 ... 80		-40 ... 80			
Ordering data				Ordering data			Ordering data		
Description	Color	Type	Order No.	Pcs./Pkt.	Type	Order No.	Pcs./Pkt.	Type	
Cable sleeves, small, slotted , can be used in sealing frames with locking latch and screw locking, for cable diameter of:									
1 mm ... 2 mm	gray	CES-STPG-GY-2	0801672	10					
2 mm ... 3 mm	gray	CES-STPG-GY-3	0801673	10					
3 mm ... 4 mm	gray	CES-STPG-GY-4	0801674	10					
4 mm ... 5 mm	gray	CES-STPG-GY-5	0801675	10					
5 mm ... 6 mm	gray	CES-STPG-GY-6	0801676	10					
6 mm ... 7 mm	gray	CES-STPG-GY-7	0801677	10					
7 mm ... 8 mm	gray	CES-STPG-GY-8	0801679	10					
8 mm ... 9 mm	gray	CES-STPG-GY-9	0801680	10					
9 mm ... 10 mm	gray	CES-STPG-GY-10	0801682	10					
10 mm ... 11 mm	gray	CES-STPG-GY-11	0801683	10					
11 mm ... 12 mm	gray	CES-STPG-GY-12	0801684	10					
12 mm ... 13 mm	gray	CES-STPG-GY-13	0801685	10					
13 mm ... 14 mm	gray	CES-STPG-GY-14	0801686	10					
14 mm ... 15 mm	gray	CES-STPG-GY-15	1410521	10					
15 mm ... 16 mm	gray	CES-STPG-GY-16	1410534	10					
16 mm ... 17 mm	gray	CES-STPG-GY-17	1410547	10					
Cable sleeves, large, slotted , can be used in sealing frames with locking latch and screw locking, for cable diameter of:									
14 mm ... 15 mm	gray				CES-LTPG-GY-15	0801687	10		
15 mm ... 16 mm	gray				CES-LTPG-GY-16	0801688	10		
16 mm ... 17 mm	gray				CES-LTPG-GY-17	0801689	10		
17 mm ... 18 mm	gray				CES-LTPG-GY-18	0801690	10		
18 mm ... 19 mm	gray				CES-LTPG-GY-19	0801691	10		
19 mm ... 20 mm	gray				CES-LTPG-GY-20	0801692	10		
20 mm ... 21 mm	gray				CES-LTPG-GY-21	0801693	10		
21 mm ... 22 mm	gray				CES-LTPG-GY-22	0801695	10		
22 mm ... 23 mm	gray				CES-LTPG-GY-23	0801696	10		
23 mm ... 24 mm	gray				CES-LTPG-GY-24	0801697	10		
24 mm ... 25 mm	gray				CES-LTPG-GY-25	0801698	10		
25 mm ... 26 mm	gray				CES-LTPG-GY-26	0801699	10		
26 mm ... 27 mm	gray				CES-LTPG-GY-27	0801700	10		
27 mm ... 28 mm	gray				CES-LTPG-GY-28	0801701	10		
28 mm ... 29 mm	gray				CES-LTPG-GY-29	0801702	10		
29 mm ... 30 mm	gray				CES-LTPG-GY-30	0801703	10		
30 mm ... 31 mm	gray				CES-LTPG-GY-31	0801705	10		
31 mm ... 32 mm	gray				CES-LTPG-GY-32	0801706	10		
32 mm ... 33 mm	gray				CES-LTPG-GY-33	0801707	10		
Cable sleeves, IP54, without bore hole , can be used in sealing frames with locking latch and screw locking									
	gray	CES-STPG-GY	0801715	10	CES-LTPG-GY	0801716	10		

Cable sleeves, thermoplastic, special formats

Advantages:

- Low flammability in accordance with UL 94 V0 of thermoplastic sleeves
- Good resistance to acids and lyes

Notes:
The CES cable entry system was developed in accordance with DIN EN 50262 (Cable glands for electrical installations).
Assemble the cable sleeves in accordance with the enclosed assembly instructions.



Cable sleeves, small, with several bore holes



Cable sleeves, small, for AS interface cables



General data	Technical data			Technical data		
	Material Degree of protection Flammability rating in accordance with UL 94 Temperature range [°C]	SEBS IP54 V0 -40 ... 80			SEBS IP54 V0 -40 ... 80	
Description	Ordering data			Ordering data		
	Type	Order No.	Pcs./Pkt.	Type	Order No.	Pcs./Pkt.
Cable sleeves, with 2 bore holes, small, slotted, can be used in sealing frames with locking latch and screw locking, for cable diameter of:						
2x 2 mm ... 3 mm	gray	CES-STPG-GY-2X3	1410424	10		
2x 3 mm ... 4 mm	gray	CES-STPG-GY-2X4	1410438	10		
2x 4 mm ... 5 mm	gray	CES-STPG-GY-2X5	0801708	10		
2x 5 mm ... 6 mm	gray	CES-STPG-GY-2X6	0801709	10		
2x 6 mm ... 7 mm	gray	CES-STPG-GY-2X7	1410110	10		
2x 7 mm ... 8 mm	gray	CES-STPG-GY-2X8	1410123	10		
2x 8 mm ... 9 mm	gray	CES-STPG-GY-2X9	1410440	10		
Cable sleeves, with 4 bore holes, small, slotted, can be used in sealing frames with locking latch and screw locking, for cable diameter of:						
4 x 2 mm ... 3 mm	gray	CES-STPG-GY-4X3	0801710	10		
4 x 3 mm ... 4 mm	gray	CES-STPG-GY-4X4	0801711	10		
4 x 4 mm ... 5 mm	gray	CES-STPG-GY-4X5	1410136	10		
4 x 5 mm ... 6 mm	gray	CES-STPG-GY-4X6	1410149	10		
Cable sleeve, IP54, slotted, for one AS-Interface cable, cable arrangement:						
L	gray			CES-STPG-GY-1ASI-L	1410068	10
R	gray			CES-STPG-GY-1ASI-R	0801712	10
Cable sleeve, IP54, slotted, for two AS-Interface cables, cable arrangement:						
LL	gray			CES-STPG-GY-2ASI-LL	1410071	10
RR	gray			CES-STPG-GY-2ASI-RR	0801713	10
LR	gray			CES-STPG-GY-2ASI-LR	0801714	10

Installation and mounting material

Accessories

Filler plugs, EMC cable catch rails

Notes:
For assembly instructions, see phoenixcontact.net/products



**Filler plugs
with a diameter of 2 mm to 17 mm**

**EMC cable catch rail
for mounting on CES sealing frames**

General data		Technical data			Technical data		
Material		PA				Stainless steel	
Degree of protection		IP54				-	
Temperature range	[°C]	-20 ... 80				- ... -	
Description		Ordering data			Ordering data		
		Order No.	Pcs./Pkt.	Order No.	Pcs./Pkt.	Order No.	Pcs./Pkt.
Filler plugs , for sealing unused cable sleeves with a diameter of:							
2 mm / 3 mm / 4 mm		1410220	25	3063921	25	3063934	25
5 mm / 6 mm / 7 mm		3063947	25	3063950	25	3063963	25
8 mm / 9 mm / 10 mm		3063976	25	3063989	25	3063992	25
11 mm / 12 mm / 13 mm		3064001	25	3062016	25	3062029	25
14 mm / 15 mm / 16 mm		3062032	25	3062045	25	3062058	25
17 mm		3062061	25				
EMC cable catch rail , for mounting on CES sealing frames							
CES-B16-... Long side						3063507	5
CES-B24-... Long side						3063510	5
CES-B16-..., CES-B24-... Short side						3063523	5

Module plates

For accommodating CES B24 sealing frames and CES Multigates cable feed-throughs.

Pre-assembled for time-saving and easy assembly:

- Partition plates
- Control cabinet bottom

Notes:
For assembly instructions, see phoenixcontact.net/products



Module plate

General data		Technical data		
Material		Stainless steel 1.4301/AISI 304		
Sealing material		NBR		
Degree of protection		IP54		
Temperature range	[°C]	-40 ... 100		
Description		Ordering data		
		Type	Order No.	Pcs./Pkt.
B24 module plates , with seal, for the CES B24 sealing frames and the B24 Multigates cable feed-throughs				
3 openings		MD-INB24-3-SZP-S	1415242	1
4 openings		MD-INB24-4-SZP-S	1415243	1

Multigates cable feed-throughs

- High degree of protection thanks to double membrane sealing
- Quick installation of unassembled cables
- Sealing frame stable in form, thanks to metal reinforcement
- Flame-retardant
- Size: 222 mm x 92 mm



CES Multigates cable feed-through, light gray



CES Multigates cable feed-through, black, oil-resistant in accordance with UL 157

Notes:
Other versions available on request.
For assembly instructions, see phoenixcontact.net/products

Technical data

Material	TPE-SEBS
Degree of protection	IP66 / IP67
Flammability rating in accordance with UL 94	V0
Temperature range	-40 ... 100

Technical data

Material	TPE-SEBS
Degree of protection	IP66 / IP67
Flammability rating in accordance with UL 94	V0
Temperature range	-40 ... 100

Ordering data

Type	Order No.	Pcs./Pkt.
MC-3/7-MULTI-67-PV-LG	1415234	1
MC-25-MULTI-65-PV-LG	1422348	1
MC-25/27-MULTI-67-PV-LG	1415236	1
MC-35-MULTI-65-PV-LG	1422350	1
MC-35/37-MULTI-67-PV-LG	1415240	1

Ordering data

Type	Order No.	Pcs./Pkt.
MC-3/7-MULTI-67-PVO-BK	1415235	1
MC-25-MULTI-65-PVO-BK	1422349	1
MC-25/27-MULTI-67-PVO-BK	1415237	1
MC-35-MULTI-65-PVO-BK	1422351	1
MC-35/37-MULTI-67-PVO-BK	1415241	1

General data

Material	TPE-SEBS
Degree of protection	IP66 / IP67
Flammability rating in accordance with UL 94	V0
Temperature range	-40 ... 100

Description

CES Multigates, cable feed-throughs for cable diameter:

- 4 x 8 - 16 mm, 2 x 24 - 54 mm, 1 x 30 - 60 mm
- 4 x 5 - 7 mm, 4 x 8 - 12 mm, 12 x 10 - 14 mm,
- 4 x 14 - 20 mm, 1 x 20 - 26 mm
- 4 x 5 - 7 mm, 4 x 8 - 12 mm, 13 x 10 - 14 mm,
- 4 x 14 - 20 mm, 2 x 20 - 26 mm
- 2 x 6 - 10 mm, 14 x 7 - 12 mm, 16 x 10 - 14 mm,
- 2 x 12 - 18 mm, 1 x 17 - 32 mm
- 4 x 6 - 10 mm, 14 x 8-12 mm, 16 x 10 - 14 mm,
- 2 x 12 - 18 mm, 1 x 17 - 32 mm

B24 Multigates cable feed-throughs

- High degree of protection thanks to double membrane sealing
- Quick installation of unassembled cables
- Sealing frame stable in form, thanks to metal reinforcement
- Flame-retardant
- Size: B24



CES B24 Multigates cable feed-through, black

Notes:
Other versions available on request.
For assembly instructions, see phoenixcontact.net/products

Technical data

Material	TPE-SEBS
Degree of protection	IP65
Flammability rating in accordance with UL 94	V0
Temperature range	-40 ... 90

Ordering data

Type	Order No.	Pcs./Pkt.
MH-25-MULTI-65-PV-BK	1424582	1
MH-27-MULTI-65-PV-BK	1424583	1
MH-10CL-MULTI-55-PV-BK	1424584	1

General data

Material	TPE-SEBS
Degree of protection	IP65
Flammability rating in accordance with UL 94	V0
Temperature range	-40 ... 90

Description

CES B24 Multigates, cable feed-throughs for cable diameter:

- 3 x 3 - 6 mm, 9 x 3 - 7 mm, 8 x 6 - 9 mm,
- 4 x 6 - 12 mm, 1 x 10 - 20 mm
- 26 x 3 - 6 mm, 1 x 10 - 20 mm
- 6 x 2 - 6 mm, 2 x 2 - 18 mm, 2 x 2 - 30 mm

Installation and mounting material

DIN rail mounting frames

Plastic DIN rail mounting frames, base frames and top frames

- For pre-assembled contact inserts
- Variable cable laying, thanks to open base frame

Notes:
For assembly instructions, see phoenixcontact.net/products



Base frame



Top frame

General data	
Material	PC
Ambient temperature (operation)	-40 ... 125 [°C]
Description	Size
DIN rail mounting frame, base frame, sizes can be variably adjusted	B6 - B24
DIN rail mounting frame, top frame	B6 B10 B16 B24

Technical data		
Material		
PC		
Ambient temperature (operation)		
-40 ... 125		
Ordering data		
Type	Order No.	Pcs./Pkt.
HC-CIF-B06-24-BFAFL-PL	1424338	1

Technical data		
Material		
PC		
Ambient temperature (operation)		
-40 ... 125		
Ordering data		
Type	Order No.	Pcs./Pkt.
HC-CIF-B06-HFWL-PL	1424334	1
HC-CIF-B10-HFWL-PL	1424335	1
HC-CIF-B16-HFWL-PL	1424336	1
HC-CIF-B24-HFWL-PL	1424337	1

Adapters, strain reliefs, and interlocks for plastic DIN rail mounting frames

Notes:
For assembly instructions, see phoenixcontact.net/products



Adapter for D series contact inserts



Strain relief and interlock, for B series EVO plastic housing

General data	
Material	Steel, galvanized
Ambient temperature (operation)	- [°C]
Description	Size
Adapter insert, for D series contact inserts	D15 D25
Strain relief, for B series EVO plastic housing	B6 - B24
Interlock, for B series EVO plastic housing	B6 - B24

Technical data		
Material		
Steel, galvanized		
Ambient temperature (operation)		
-		
Ordering data		
Type	Order No.	Pcs./Pkt.
HC-CIF-D15-AIWS-SM-NI	1424340	1
HC-CIF-D25-AIWS-SM-NI	1424341	1

Technical data		
Material		
PA		
Ambient temperature (operation)		
-		
Ordering data		
Type	Order No.	Pcs./Pkt.
HC-B-SG-PL-BK	1424343	1
HC-CIF-B06-24-AEWL-PL-BK	1424342	1

Metal DIN rail mounting frames, base frames

- For pre-assembled contact inserts
- Grounding for DIN rail

Notes:
The aluminum design provides a capacitive PE.
For assembly instructions, see phoenixcontact.net/products



Base frame, without double locking latch, for screw locking



Base frame, with double locking latch

Technical data

Material	Cast aluminum, uncoated
Ambient temperature (operation)	-40 ... 125

Ordering data

Type	Order No.	Pcs./Pkt.
HC-CIF-2B6-BFFD-FH-AL	1404214	1
HC-CIF-B10-BFFD-FH-AL	1404219	1
HC-CIF-B16-BFFD-FH-AL	1404216	1
HC-CIF-B24-BFFD-FH-AL	1404211	1
SF-M BH	1212070	5
SF-BIT-HEX 3-50	1212647	5

Technical data

Material	Cast aluminum, uncoated
Ambient temperature (operation)	-40 ... 125

Ordering data

Type	Order No.	Pcs./Pkt.
HC-CIF-B10-BFWD-FH-AL	1404220	1
HC-CIF-B16-BFWD-FH-AL	1404217	1
HC-CIF-B24-BFWD-FH-AL	1404212	1
SF-M BH	1212070	5
SF-BIT-HEX 3-50	1212647	5

General data

Material	Cast aluminum, uncoated
Ambient temperature (operation)	-40 ... 125

Description

Description	Size
DIN rail mounting frame, base frame	For 2xB6 For B10 For B16 For B24
Bit screwdriver , with 1/4" quick-action chuck, suitable for bits in accordance with DIN 3126-C 6.3 and E 6.3/ISO 1173, magnetic	
Bit screwdriver	
Screw bit , size: hex 3 x 50 mm	

Plastic DIN rail mounting frames, top frames

- Housing made from robust die-cast aluminum

Notes:
The aluminum design provides a capacitive PE.
For assembly instructions, see phoenixcontact.net/products



Top frame, for double locking latch

Technical data

Material	Cast aluminum, uncoated
Ambient temperature (operation)	-40 ... 125

Ordering data

Type	Order No.	Pcs./Pkt.
HC-CIF-2B6-HFFD-WH-AL	1404215	1
HC-CIF-B10-HFFD-WH-AL	1404221	1
HC-CIF-B16-HFFD-WH-AL	1404218	1
HC-CIF-B24-HFFD-WH-AL	1404213	1
SF-M BH	1212070	5
SF-BIT-HEX 3-50	1212647	5

General data

Material	Cast aluminum, uncoated
Ambient temperature (operation)	-40 ... 125

Description

Description	Size
DIN rail mounting frame, top frame, for double locking latch and optionally with locking screws, Allen screw, wrench size 3	For 2xB6 For B10 For B16 For B24
Bit screwdriver , with 1/4" quick-action chuck, suitable for bits in accordance with DIN 3126-C 6.3 and E 6.3/ISO 1173, magnetic	
Bit screwdriver	
Screw bit , size: hex 3 x 50 mm	

Installation and mounting material

Cable glands

Plastic cable glands, metric, EN 60423

- Material: polyamide 6
- UV-resistant: f1 in accordance with UL 746C
- Cable seal: CR
- Ambient temperature: -20°C ... +100°C
- Degree of protection: IP66/IP68
- Strain relief: integrated in accordance with EN 62444

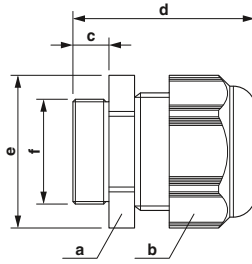

Plastic cable gland

Thread type	Clamping area [mm]	Dimensions [mm]					Thread
		a	b	c	d	e	
M12 x 1.5	3.00 - 6.50	15.00	15.00	8.00	32.00	17.10	M12
M16 x 1.5	4.00 - 8.00	19.00	19.00	8.00	43.00	25.00	M16
M16 x 1.5	5.00 - 10.00	22.00	22.00	10.00	39.00	25.00	M16
M20 x 1.5	6.00 - 12.00	24.00	24.00	10.00	42.00	27.80	M20
M20 x 1.5	10.00 - 14.00	27.00	27.00	10.00	43.00	27.80	M20
M25 x 1.5	11.00 - 17.00	29.00	29.00	8.00	43.00	33.50	M25
M25 x 1.5	13.00 - 18.00	33.00	33.00	10.00	45.50	33.50	M25
M32 x 1.5	15.00 - 21.00	36.00	36.00	10.00	50.00	40.90	M32
M32 x 1.5	18.00 - 25.00	42.00	42.00	15.00	56.00	40.90	M32
M40 x 1.5	19.00 - 28.00	46.00	46.00	10.00	55.00	52.00	M40
M40 x 1.5	22.00 - 32.00	53.00	53.00	18.00	55.00	52.00	M40
M50 x 1.5	30.00 - 36.00	60.00	60.00	18.00	71.00	67.70	M50
M63 x 1.5	34.00 - 44.00	65.00	65.00	18.00	75.00	72.20	M63

Ordering data					
Order No.	Pcs./Pkt.	Order No.	Pcs./Pkt.	Order No.	Pcs./Pkt.
light gray		silver-gray		black	
1417652	10	1411123	10	1411131	10
1424470	10	1424475	10	1424480	10
1417653	10	1411124	10	1411132	10
1414568	5	1411125	5	1411133	5
1424471	5	1424476	5	1424481	5
1417654	5	1411126	5	1411134	5
1424472	5	1424477	5	1424482	5
1417655	5	1411127	5	1411136	5
1424473	5	1424478	5	1424483	5
1417656	5	1411128	5	1411137	5
1424474	5	1424479	5	1424484	5
1417657	1	1411129	1	1411138	1
1417658	1	1411130	1	1411139	1

Plastic counter nuts, metric, EN 60423

- Material: polyamide 6
- Ambient temperature: -20°C ... +100°C

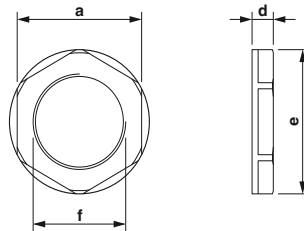

Plastic counter nut

Thread type	Clamping area [mm]	Dimensions [mm]					Thread
		a	b	c	d	e	
M12 x 1.5	-	18.00	-	-	5.00	19.50	M12
M16 x 1.5	-	22.00	-	-	5.00	24.20	M16
M20 x 1.5	-	26.00	-	-	6.00	28.60	M20
M25 x 1.5	-	32.00	-	-	6.00	35.00	M25
M32 x 1.5	-	41.00	-	-	7.00	46.10	M32
M40 x 1.5	-	50.00	-	-	7.00	55.30	M40
M50 x 1.5	-	60.00	-	-	8.00	66.10	M50
M63 x 1.5	-	75.00	-	-	8.00	82.50	M63

Ordering data					
Order No.	Pcs./Pkt.	Order No.	Pcs./Pkt.	Order No.	Pcs./Pkt.
light gray		silver-gray		black	
1417659	10	1411205	10	1411213	10
1417660	10	1411206	10	1411214	10
1414570	5	1411207	5	1411215	5
1417661	5	1411208	5	1411216	5
1417662	5	1411209	5	1411217	5
1417664	5	1411210	5	1411218	5
1417665	5	1411211	5	1411219	5
1417666	5	1411212	5	1411220	5

**Plastic cable glands,
Pg, EN 40430**

- Material: polyamide 6
- UV-resistant: f1 in accordance with UL 746C
- Cable seal: CR
- Ambient temperature: -20°C ... +100°C
- Degree of protection: IP66/IP68
- Strain relief: integrated

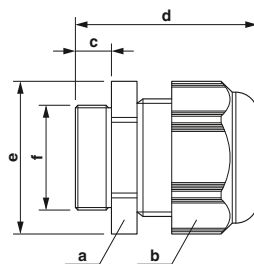

Plastic cable gland

Thread type	Clamping area [mm]	Dimensions [mm]					Thread
		a	b	c	d	e	
Pg7	3.00 - 6.50	15.00	15.00	8.00	32.00	17.10	Pg7
Pg9	4.00 - 8.00	19.00	19.00	8.00	36.00	21.60	Pg9
Pg11	5.00 - 10.00	22.00	22.00	8.00	38.00	25.00	Pg11
Pg13.5	6.00 - 12.00	24.00	24.00	10.00	40.00	27.80	Pg13.5
Pg16	10.00 - 14.00	27.00	27.00	10.00	44.00	30.80	Pg16
Pg21	13.00 - 18.00	33.00	33.00	11.00	49.00	37.80	Pg21
Pg29	18.00 - 25.00	42.00	42.00	11.00	53.00	48.00	Pg29
Pg36	22.00 - 32.00	53.00	53.00	13.00	65.00	60.00	Pg36
Pg42	30.00 - 38.00	60.00	60.00	13.00	65.00	67.70	Pg42
Pg48	34.00 - 44.00	65.00	65.00	14.00	68.00	72.20	Pg48

Ordering data					
Order No.	Pcs./Pkt.	Order No.	Pcs./Pkt.	Order No.	Pcs./Pkt.
light gray		silver-gray		black	
1424485	10	1411140	10	1424495	10
1424486	10	1411141	10	1424496	10
1424487	5	1411142	5	1424497	5
1424488	5	1411143	5	1424498	5
1424489	5	1411144	5	1424499	5
1424490	5	1411145	5	1424500	5
1424491	5	1411146	5	1424501	5
1424492	5	1411147	5	1424502	5
1424493	1	1411149	1	1424503	1
1424494	1	1411150	1	1424504	1

**Plastic counter nuts,
Pg, EN 40430**

- Material: polyamide 6
- Ambient temperature: -20°C ... +100°C

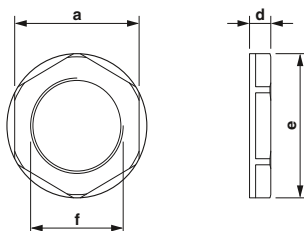

Plastic counter nut

Thread type	Clamping area [mm]	Dimensions [mm]					Thread
		a	b	c	d	e	
Pg7	-	19.00	-	-	5.00	21.00	Pg7
Pg9	-	22.00	-	-	5.00	24.00	Pg9
Pg11	-	24.00	-	-	5.00	26.00	Pg11
Pg13.5	-	27.00	-	-	6.00	29.00	Pg13.5
Pg16	-	30.00	-	-	6.00	33.00	Pg16
Pg21	-	36.00	-	-	7.00	39.00	Pg21
Pg29	-	46.00	-	-	7.00	50.00	Pg29
Pg36	-	60.00	-	-	8.00	66.00	Pg36
Pg42	-	65.00	-	-	8.00	73.00	Pg42
Pg48	-	70.00	-	-	8.00	78.00	Pg48

Ordering data					
Order No.	Pcs./Pkt.	Order No.	Pcs./Pkt.	Order No.	Pcs./Pkt.
light gray		silver-gray		black	
1424548	10	1411221	10	1424558	10
1424549	10	1411222	10	1424559	10
1424550	5	1411223	5	1424560	5
1424551	5	1411224	5	1424561	5
1424552	5	1411225	5	1424562	5
1424553	5	1411226	5	1424563	5
1424554	5	1411227	5	1424564	5
1424555	5	1411228	5	1424565	5
1424556	5	1411229	5	1424566	5
1424557	5	1411230	5	1424567	5

Installation and mounting material

Cable glands

Brass cable glands, metric, EN 60423

- Material: brass, nickel-plated
- Cable seal: CR
- O-ring: NBR
- Ambient temperature: -40°C ... +100°C
- Degree of protection: IP66/IP68/IP69
- Strain relief: integrated in accordance with EN 62444

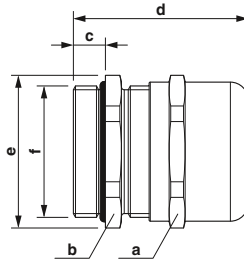

Brass cable gland

Notes:
For alternative clamping ranges, see phoenixcontact.net/products

Thread type	Color	Clamping area [mm]	Dimensions [mm]					Thread
			a	b	c	d	e	
M12 x 1.5	silver	3.00 - 6.50	14.00	14.00	6.00	27.00	15.50	M12
M16 x 1.5	silver	4.00 - 8.00	17.00	18.00	7.00	30.00	22.00	M16
M16 x 1.5	silver	5.00 - 10.00	20.00	20.00	7.00	34.00	22.00	M16
M20 x 1.5	silver	6.00 - 12.00	22.00	22.00	8.00	37.00	24.50	M20
M25 x 1.5	silver	10.00 - 14.00	24.00	27.00	8.00	36.00	30.00	M25
M25 x 1.5	silver	11.00 - 17.00	27.00	27.00	8.00	40.00	30.00	M25
M32 x 1.5	silver	13.00 - 18.00	30.00	34.00	9.00	42.00	37.00	M32
M32 x 1.5	silver	15.00 - 21.00	34.00	34.00	8.00	43.00	37.00	M32
M40 x 1.5	silver	18.00 - 25.00	40.00	43.00	9.00	47.00	48.40	M40
M40 x 1.5	silver	19.00 - 28.00	43.00	43.00	9.00	53.00	48.40	M40
M50 x 1.5	silver	22.00 - 32.00	50.00	55.00	9.00	58.00	64.00	M50
M50 x 1.5	silver	27.00 - 38.00	58.00	58.00	9.00	61.00	64.00	M50
M63 x 1.5	silver	34.00 - 44.00	64.00	68.00	14.00	65.00	70.00	M63
M63 x 1.5	silver	37.00 - 53.00	75.00	75.00	10.00	60.00	70.00	M63

Ordering data		
Type	Order No.	Pcs./Pkt.
G-INS-M12-S68N-NNES-S	1411160	10
G-INS-M16-T68N-NNES-S	1424526	10
G-INS-M16-S68N-NNES-S	1411162	10
G-INS-M20-S68N-NNES-S	1411163	5
G-INS-M25-S68N-NNES-S	1424527	5
G-INS-M25-M68N-NNES-S	1411165	5
G-INS-M32-S68N-NNES-S	1424528	5
G-INS-M32-M68N-NNES-S	1411166	5
G-INS-M40-S68N-NNES-S	1424529	5
G-INS-M40-M68N-NNES-S	1411167	5
G-INS-M50-M68N-NNES-S	1424530	1
G-INS-M50-L68N-NNES-S	1411168	1
G-INS-M63-L68N-NNES-S	1411169	1
G-INS-M63-E68N-NNES-S	1424531	1

Brass counter nuts, metric, EN 60423

- Material: brass, nickel-plated
- Ambient temperature: -70°C ... +220°C

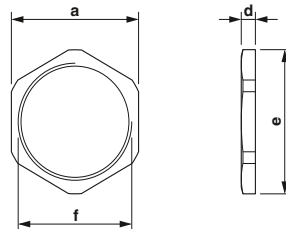

Brass counter nut

Thread type	Color	Clamping area [mm]	Dimensions [mm]					Thread
			a	b	c	d	e	
M12 x 1.5	silver	-	15.00	-	-	2.80	16.50	M12
M16 x 1.5	silver	-	19.00	-	-	2.80	21.00	M16
M20 x 1.5	silver	-	24.00	-	-	3.00	27.00	M20
M25 x 1.5	silver	-	30.00	-	-	3.50	33.50	M25
M32 x 1.5	silver	-	36.00	-	-	4.00	40.00	M32
M40 x 1.5	silver	-	46.00	-	-	5.00	50.00	M40
M50 x 1.5	silver	-	57.00	-	-	5.00	65.00	M50
M63 x 1.5	silver	-	70.00	-	-	6.00	75.00	M63

Ordering data		
Type	Order No.	Pcs./Pkt.
A-INL-M12-N-S	1411240	100
A-INL-M16-N-S	1411241	100
A-INL-M20-N-S	1411242	100
A-INL-M25-N-S	1411243	100
A-INL-M32-N-S	1411244	100
A-INL-M40-N-S	1411246	50
A-INL-M50-N-S	1411247	25
A-INL-M63-N-S	1411248	25

**Brass cable glands,
Pg, EN 40430**

- Material: brass, nickel-plated
- Cable seal: CR
- O-ring: NBR
- Ambient temperature:
-40°C ... +100°C
- Degree of protection: IP68/IP69
- Strain relief: integrated

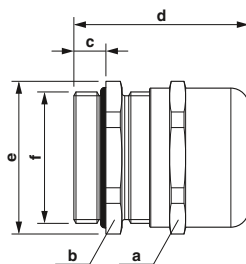

Brass cable gland

Thread type	Color	Clamping area [mm]	Dimensions [mm]					Thread
			a	b	c	d	e	
Pg7	silver	3.00 - 6.50	14.00	14.00	6.00	27.00	15.50	Pg7
Pg9	silver	4.00 - 8.00	17.00	17.00	6.00	28.00	18.90	Pg9
Pg11	silver	5.00 - 10.00	20.00	20.00	6.00	21.00	22.00	Pg11
Pg13.5	silver	6.00 - 12.00	22.00	22.00	6.50	30.00	24.50	Pg13.5
Pg16	silver	10.00 - 14.00	24.00	24.00	6.50	33.00	26.80	Pg16
Pg21	silver	13.00 - 18.00	30.00	30.00	7.20	38.00	33.00	Pg21
Pg29	silver	18.00 - 25.00	40.00	40.00	8.00	46.00	44.50	Pg29
Pg36	silver	22.00 - 32.00	50.00	50.00	9.00	57.00	55.50	Pg36
Pg42	silver	30.00 - 38.00	58.00	58.00	12.00	60.00	64.00	Pg42
Pg48	silver	34.00 - 44.00	64.00	64.00	14.00	63.00	70.00	Pg48

Ordering data		
Type	Order No.	Pcs./Pkt.
G-INS-PG7-S68N-NNES-S	1411170	10
G-INS-PG9-S68N-NNES-S	1411171	10
G-INS-PG11-S68N-NNES-S	1411172	5
G-INS-PG13,5-S68N-NNES-S	1411173	5
G-INS-PG16-S68N-NNES-S	1411174	5
G-INS-PG21-M68N-NNES-S	1411175	5
G-INS-PG29-M68N-NNES-S	1411176	5
G-INS-PG36-L68N-NNES-S	1411178	5
G-INS-PG42-L68N-NNES-S	1411179	1
G-INS-PG48-L68N-NNES-S	1411181	1

**Brass counter nuts,
Pg, EN 40430**

- Material: brass, nickel-plated
- Ambient temperature:
-70°C ... +220°C

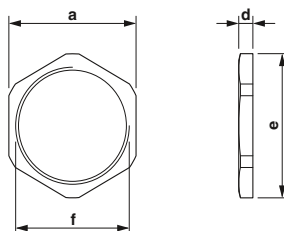

Brass counter nut

Thread type	Color	Clamping area [mm]	Dimensions [mm]					Thread
			a	b	c	d	e	
Pg7	silver	-	15.00	-	-	2.80	16.50	Pg7
Pg9	silver	-	18.00	-	-	2.80	20.00	Pg9
Pg11	silver	-	21.00	-	-	3.00	24.00	Pg11
Pg13.5	silver	-	23.00	-	-	3.00	26.00	Pg13.5
Pg16	silver	-	26.00	-	-	3.00	29.00	Pg16
Pg21	silver	-	32.00	-	-	3.50	36.00	Pg21
Pg29	silver	-	41.00	-	-	4.00	45.00	Pg29
Pg36	silver	-	51.00	-	-	5.00	56.00	Pg36
Pg42	silver	-	60.00	-	-	5.00	65.00	Pg42
Pg48	silver	-	64.00	-	-	5.50	69.00	Pg48

Ordering data		
Type	Order No.	Pcs./Pkt.
A-INL-PG7-N-S	1411255	100
A-INL-PG9-N-S	1411256	100
A-INL-PG11-N-S	1411257	100
A-INL-PG13,5-N-S	1411259	100
A-INL-PG16-N-S	1411260	100
A-INL-PG21-N-S	1411262	100
A-INL-PG29-N-S	1411263	50
A-INL-PG36-N-S	1411264	50
A-INL-PG42-N-S	1411265	25
A-INL-PG48-N-S	1411266	25

Installation and mounting material

Cable glands

Brass EMC cable glands, metric, EN 60423

- Material: brass, nickel-plated
- Cable seal: CR
- O-ring: NBR
- Ambient temperature: -40°C ... +100°C
- Degree of protection: IP66/IP68
- Strain relief: integrated in accordance with EN 62444

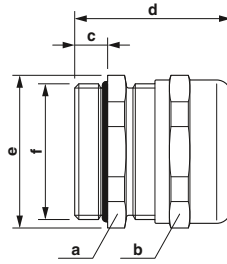

Brass EMC cable gland

Thread type	Color	Clamping area [mm]	Dimensions [mm]					Thread	
			a	b	c	d	e	f	
M12 x 1.5	silver	4.00 - 6.50	14.00	14.00	6.00	28.00	15.50	M12	
M16 x 1.5	silver	5.00 - 10.00	20.00	20.00	7.00	-	22.00	M16	
M20 x 1.5	silver	9.00 - 13.00	22.00	22.00	6.00	33.00	24.00	M20	
M25 x 1.5	silver	11.00 - 16.00	27.00	27.00	7.00	36.00	30.00	M25	
M32 x 1.5	silver	14.00 - 21.00	34.00	34.00	8.00	38.00	36.00	M32	
M40 x 1.5	silver	19.00 - 27.00	43.00	43.00	8.00	41.00	46.00	M40	
M50 x 1.5	silver	24.00 - 35.00	55.00	55.00	9.00	49.00	60.00	M50	
M63 x 1.5	silver	32.00 - 42.00	65.00	65.00	10.00	52.00	70.00	M63	

Ordering data		
Type	Order No.	Pcs./Pkt.
G-INSEC-M12-S68N-NCRS-S	1411187	10
G-INSEC-M16-S68L-NCRS-S	1077099	10
G-INSEC-M20-S68N-NCRS-S	1411189	5
G-INSEC-M25-S68N-NCRS-S	1411190	5
G-INSEC-M32-M68N-NCRS-S	1411191	5
G-INSEC-M40-M68N-NCRS-S	1411192	5
G-INSEC-M50-L68N-NCRS-S	1411193	1
G-INSEC-M63-L68N-NCRS-S	1411194	1

Brass counter nuts, metric, EN 60423, ribbed

- Material: brass, nickel-plated
- Ambient temperature: -70°C ... +220°C
- Version: ribbed

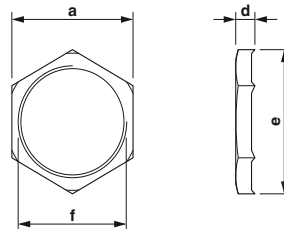

Brass counter nut

Thread type	Color	Clamping area [mm]	Dimensions [mm]					Thread	
			a	b	c	d	e	f	
M12 x 1.5	silver	-	15.00	-	-	4.70	16.50	M12	
M16 x 1.5	silver	-	19.00	-	-	4.70	21.00	M16	
M20 x 1.5	silver	-	24.00	-	-	4.70	27.00	M20	
M25 x 1.5	silver	-	30.00	-	-	5.20	33.50	M25	
M32 x 1.5	silver	-	36.00	-	-	5.70	40.00	M32	
M40 x 1.5	silver	-	46.00	-	-	6.50	50.00	M40	
M50 x 1.5	silver	-	60.00	-	-	6.50	65.00	M50	
M63 x 1.5	silver	-	70.00	-	-	7.00	75.00	M63	

Ordering data		
Type	Order No.	Pcs./Pkt.
A-INLE-M12-N-S	1411267	100
A-INLE-M16-N-S	1411268	100
A-INLE-M20-N-S	1411269	100
A-INLE-M25-N-S	1411270	50
A-INLE-M32-N-S	1411271	50
A-INLE-M40-N-S	1411272	50
A-INLE-M50-N-S	1411273	10
A-INLE-M63-N-S	1411274	10

**Brass EMC cable glands,
Pg, EN 40430**

- Material: brass, nickel-plated
- Cable seal: CR
- O-ring: NBR
- Ambient temperature:
-40°C ... +100°C
- Degree of protection: IP66/IP68
- Strain relief: integrated

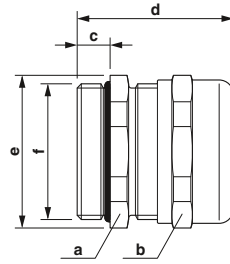

Brass EMC cable gland

Thread type	Color	Clamping area [mm]	Dimensions [mm]					Thread
			a	b	c	d	e	
Pg7	silver	3.00 - 6.50	14.00	14.00	6.00	27.00	15.50	Pg7
Pg9	silver	4.00 - 8.00	17.00	17.00	6.00	29.00	18.90	Pg9
Pg11	silver	5.00 - 10.00	20.00	20.00	6.00	30.00	22.00	Pg11
Pg13.5	silver	6.00 - 12.00	22.00	22.00	6.50	30.00	24.50	Pg13.5
Pg16	silver	10.00 - 14.00	24.00	24.00	6.50	33.00	26.80	Pg16
Pg21	silver	13.00 - 18.00	30.00	30.00	7.20	38.00	33.00	Pg21
Pg29	silver	18.00 - 25.00	40.00	40.00	8.00	47.00	44.50	Pg29
Pg36	silver	22.00 - 32.00	50.00	50.00	9.00	57.00	55.50	Pg36
Pg42	silver	30.00 - 38.00	58.00	58.00	12.00	60.00	64.00	Pg42
Pg48	silver	34.00 - 44.00	64.00	64.00	14.00	65.00	70.00	Pg48

Ordering data

Type	Order No.	Pcs./Pkt.
G-INSEC-PG7-S68N-NNES-S	1411195	10
G-INSEC-PG9-S68N-NNES-S	1411196	10
G-INSEC-PG11-S68N-NNES-S	1411197	5
G-INSEC-PG13,5-S68N-NNES-S	1411198	5
G-INSEC-PG16-S68N-NNES-S	1411199	5
G-INSEC-PG21-M68N-NNES-S	1411200	5
G-INSEC-PG29-M68N-NNES-S	1411201	5
G-INSEC-PG36-L68N-NNES-S	1411202	5
G-INSEC-PG42-L68N-NNES-S	1411203	1
G-INSEC-PG48-L68N-NNES-S	1411204	1

**Brass counter nuts,
Pg, EN 40430, ribbed**

- Material: brass, nickel-plated
- Ambient temperature:
-70°C ... +220°C
- Version: ribbed

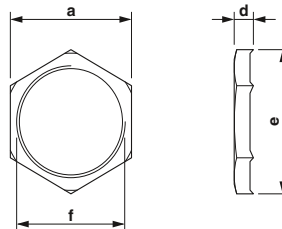

Brass counter nut

Thread type	Color	Clamping area [mm]	Dimensions [mm]					Thread
			a	b	c	d	e	
Pg7	silver	-	15.00	-	-	4.70	16.50	Pg7
Pg9	silver	-	18.00	-	-	4.70	20.00	Pg9
Pg11	silver	-	21.00	-	-	4.70	24.00	Pg11
Pg13.5	silver	-	23.00	-	-	4.70	26.00	Pg13.5
Pg16	silver	-	26.00	-	-	4.70	29.00	Pg16
Pg21	silver	-	32.00	-	-	5.20	36.00	Pg21
Pg29	silver	-	41.00	-	-	5.70	45.00	Pg29
Pg36	silver	-	51.00	-	-	6.50	56.00	Pg36

Ordering data

Type	Order No.	Pcs./Pkt.
A-INLE-PG7-N-S	1411275	100
A-INLE-PG9-N-S	1411276	100
A-INLE-PG11-N-S	1411277	100
A-INLE-PG13,5-N-S	1411278	100
A-INLE-PG16-N-S	1411279	100
A-INLE-PG21-N-S	1411280	50
A-INLE-PG29-N-S	1411281	50
A-INLE-PG36-N-S	1411282	50

Installation and mounting material

Cable glands

Stainless steel cable glands, metric, EN 60423

- Material: stainless steel
- Cable seal: CR
- O-ring: NBR
- Ambient temperature: -40°C ... +100°C
- Degree of protection: IP66/IP68/IP69
- Strain relief: integrated in accordance with EN 62444

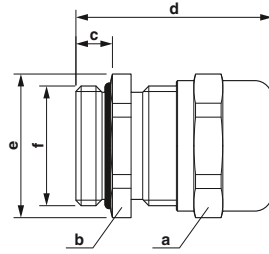

Stainless steel cable gland

Thread type	Color	Clamping area [mm]	Dimensions [mm]					Thread	
			a	b	c	d	e	f	
M12 x 1.5	silver	3.00 - 6.50	14.00	14.00	6.00	33.50	15.50	M12	
M16 x 1.5	silver	5.00 - 10.00	22.00	22.00	7.00	35.00	24.50	M16	
M20 x 1.5	silver	6.00 - 12.00	22.00	22.00	8.00	33.00	24.50	M20	
M25 x 1.5	silver	11.00 - 17.00	27.00	27.00	8.00	40.00	29.80	M25	
M32 x 1.5	silver	15.00 - 21.00	36.00	36.00	8.00	45.00	38.90	M32	
M40 x 1.5	silver	19.00 - 28.00	46.00	46.00	9.00	52.50	51.50	M40	

Ordering data		
Type	Order No.	Pcs./Pkt.
G-INS-M12-M68N-SNES-S	1424541	1
G-INS-M16-M68N-SNES-S	1424542	1
G-INS-M20-M68N-SNES-S	1424543	1
G-INS-M25-M68N-SNES-S	1424544	1
G-INS-M32-M68N-SNES-S	1424545	1
G-INS-M40-M68N-SNES-S	1424546	1

Stainless steel counter nuts, metric, EN 60423

- Material: stainless steel
- Ambient temperature: -70°C ... +220°C

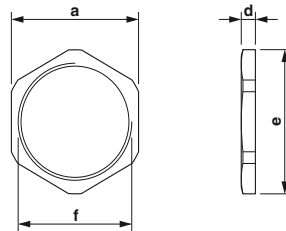

Stainless steel counter nut

Thread type	Color	Clamping area [mm]	Dimensions [mm]					Thread	
			a	b	c	d	e	f	
M12 x 1.5	silver	-	15.00	-	-	2.80	16.50	M12	
M16 x 1.5	silver	-	19.00	-	-	2.80	20.90	M16	
M20 x 1.5	silver	-	24.00	-	-	3.00	27.00	M20	
M25 x 1.5	silver	-	30.00	-	-	3.50	33.50	M25	
M32 x 1.5	silver	-	36.00	-	-	4.00	40.00	M32	
M40 x 1.5	silver	-	46.00	-	-	5.00	50.00	M40	
M50 x 1.5	silver	-	55.00	-	-	5.00	65.00	M50	
M63 x 1.5	silver	-	70.00	-	-	6.00	75.00	M63	

Ordering data		
Type	Order No.	Pcs./Pkt.
A-INL-M12-S-S	1425175	10
A-INL-M16-S-S	1425176	10
A-INL-M20-S-S	1411249	10
A-INL-M25-S-S	1411250	10
A-INL-M32-S-S	1411251	5
A-INL-M40-S-S	1411252	5
A-INL-M50-S-S	1411253	2
A-INL-M63-S-S	1411254	1

Membrane cable glands

- Material: polypropylene
- For panel thickness of 0.8 mm ... 3.5 mm
- UV-resistant
- Ambient temperature:
-40°C ... +65°C
- Degree of protection: IP66/IP67

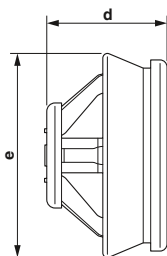

Membrane cable gland

Thread type	Color	Clamping area [mm]
M16	light gray	4.00 - 10.00
M20	light gray	6.00 - 13.00
M25	light gray	9.00 - 17.00

Dimensions [mm]					Thread
a	b	c	d	e	f
-	-	8.00	15.00	32.00	M16
-	-	8.00	15.00	34.00	M20
-	-	8.00	15.00	40.00	M25

Ordering data		
Type	Order No.	Pcs./Pkt.
MG-INC-M16-S67L-PTES-LG	1415186	20
MG-INC-M20-S67L-PTES-LG	1415187	20
MG-INC-M25-M67L-PTES-LG	1415188	20

Installation and mounting material

Cable glands

Plastic pressure compensation cable glands, metric, EN 60423

Reduces the formation of condensation

- Material: polyamide
- Cable seal: CR
- Flat gasket: NBR
- Ambient temperature: -20°C ... +100°C
- Degree of protection: IP66/IP67

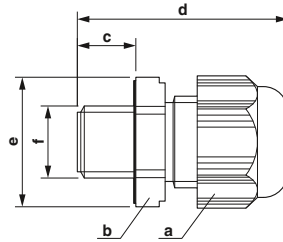

Plastic pressure compensation cable gland

Notes:
For counter nuts, see page 686

Thread type	Clamping area [mm]	Dimensions [mm]					Thread	
		a	b	c	d	e	f	
M12 x 1.5	4.00 - 7.00	19.00	19.00	8.00	33.00	-	M12	
M16 x 1.5	4.00 - 7.00	19.00	19.00	10.00	35.50	-	M16	
M20 x 1.5	6.00 - 11.00	24.00	24.00	10.00	40.00	-	M20	

Ordering data			
Order No.	Pcs./Pkt.	Order No.	Pcs./Pkt.
light gray		black	
1424532	5	1424535	5
1424533	5	1424536	5
1424534	5	1424537	5

Brass pressure compensation cable glands, metric, EN 60423

Reduces the formation of condensation

- Material: brass, nickel-plated
- Cable seal: CR
- O-ring: NBR
- Ambient temperature: -20°C ... +100°C
- Degree of protection: IP66/IP67

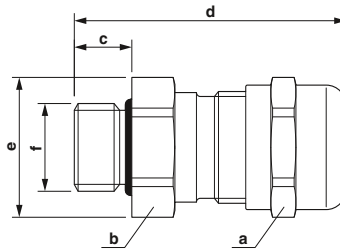

Brass pressure compensation cable gland

Notes:
For counter nuts, see page 692

Thread type	Color	Clamping area [mm]	Dimensions [mm]					Thread	
			a	b	c	d	e	f	
M12 x 1.5	silver	4.00 - 7.00	17.00	17.00	6.00	36.50	-	M12	
M16 x 1.5	silver	4.00 - 7.00	17.00	17.00	5.00	32.00	-	M16	
M20 x 1.5	silver	6.00 - 11.00	22.00	22.00	8.00	35.00	-	M20	

Ordering data		
Type	Order No.	Pcs./Pkt.
G-INVEN-M12-M67N-NNES-S	1424538	1
G-INVEN-M16-M67N-NNES-S	1424539	1
G-INVEN-M20-M67N-NNES-S	1424540	1

Plastic pressure compensation elements, metric, EN 60423

Reduces the formation of condensation

- Material: polyamide
- O-ring: NBR
- Ambient temperature: -40°C ... +105°C
- Degree of protection: IP66/IP67/IP69

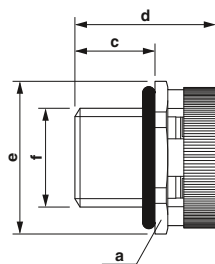

Plastic pressure compensation element

Thread type	Clamping area [mm]	Dimensions [mm]					Thread
		a	b	c	d	e	
M12 x 1.5	-	17.00	-	10.00	17.50	18.50	M12

Ordering data			
Order No.	Pcs./Pkt.	Order No.	Pcs./Pkt.
light gray		black	
1415222	5	1415223	5

Stainless steel pressure compensation element, metric, EN 60423

Reduces the formation of condensation

- Material: stainless steel
- O-ring: NBR
- Ambient temperature: -40°C ... +105°C
- Degree of protection: IP66/IP67/IP69

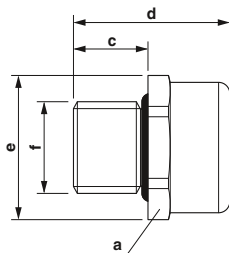

Stainless steel pressure compensation element

Thread type	Color	Clamping area [mm]	Dimensions [mm]					Thread
			a	b	c	d	e	
M12 x 1.5	silver	-	17.00	-	10.00	21.00	18.50	M12

Ordering data		
Type	Order No.	Pcs./Pkt.
A-INB-M12-69KN-S-S	1415224	5

Installation and mounting material

Cable glands

Plastic cable glands with bend protection, metric, EN 60423

- Material: polyamide
- Cable seal: EPDM
- O-ring: EPDM
- Ambient temperature: -40°C ... +100°C
- Degree of protection: IP68/IP69

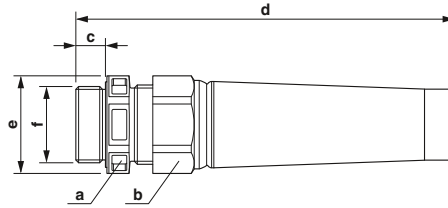

Plastic cable gland with bend protection

Thread type	Clamping area [mm]	Dimensions [mm]					Thread	
		a	b	c	d	e	f	
M12 x 1.5	3.00 - 7.00	16.00	16.00	9.00	72.00	18.00	M12	
M16 x 1.5	4.50 - 10.00	20.00	20.00	9.00	82.00	22.00	M16	
M20 x 1.5	6.00 - 13.00	24.00	24.00	12.00	103.00	27.00	M20	
M25 x 1.5	9.00 - 17.00	29.00	29.00	12.00	113.00	32.00	M25	
M32 x 1.5	13.00 - 21.00	36.00	36.00	12.00	138.00	40.00	M32	

Ordering data			
Order No.	Pcs./Pkt.	Order No.	Pcs./Pkt.
light gray		black	
1415171	10	1415177	10
1415172	10	1415178	10
1415174	10	1415179	10
1415175	10	1415180	10
1415176	5	1415181	5

Plastic counter nuts, metric, EN 60423

- Material: polyamide 6
- Ambient temperature: -20°C ... +100°C

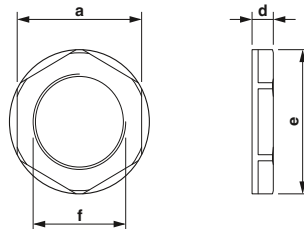

Plastic counter nut

Thread type	Clamping area [mm]	Dimensions [mm]					Thread	
		a	b	c	d	e	f	
M12 x 1.5	-	18.00	-	-	5.00	19.50	M12	
M16 x 1.5	-	22.00	-	-	5.00	24.20	M16	
M20 x 1.5	-	26.00	-	-	6.00	28.60	M20	
M25 x 1.5	-	32.00	-	-	6.00	35.00	M25	
M32 x 1.5	-	41.00	-	-	7.00	46.10	M32	

Ordering data			
Order No.	Pcs./Pkt.	Order No.	Pcs./Pkt.
light gray		black	
1417659	10	1411213	10
1417660	10	1411214	10
1414570	5	1411215	5
1417661	5	1411216	5
1417662	5	1411217	5

Brass cable glands with bend protection, metric, EN 60423

- Material: brass, nickel-plated
- Cable seal: EPDM
- O-ring: EPDM
- Ambient temperature: -40°C ... +100°C
- Degree of protection: IP68/IP69

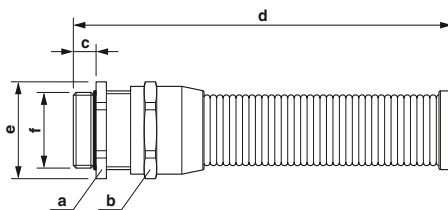

Brass cable gland with bend protection

Thread type	Color	Clamping area [mm]	Dimensions [mm]					Thread
			a	b	c	d	e	
M20 x 1.5	silver	6.00 - 13.00	24.00	24.00	6.00	96.00	27.00	M20
M25 x 1.5	silver	9.00 - 17.00	29.00	29.00	7.00	120.00	32.00	M25
M32 x 1.5	silver	13.00 - 21.00	36.00	36.00	8.00	146.00	40.00	M32
M40 x 1.5	silver	16.00 - 28.00	46.00	46.00	8.00	184.00	51.00	M40

Ordering data		
Type	Order No.	Pcs./Pkt.
G-INB-M20-S68N-NEPDS-S	1415182	5
G-INB-M25-M68N-NEPDS-S	1415183	5
G-INB-M32-M68N-NEPDS-S	1415184	1
G-INB-M40-M68N-NEPDS-S	1415185	1

Brass counter nuts, metric, EN 60423

- Material: brass, nickel-plated
- Ambient temperature: -70°C ... +220°C

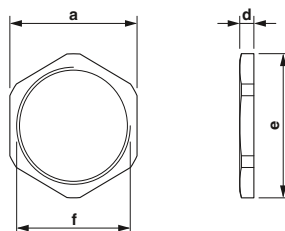

Brass counter nut

Thread type	Color	Clamping area [mm]	Dimensions [mm]					Thread
			a	b	c	d	e	
M20 x 1.5	silver	-	24.00	-	-	3.00	27.00	M20
M25 x 1.5	silver	-	30.00	-	-	3.50	33.50	M25
M32 x 1.5	silver	-	36.00	-	-	4.00	40.00	M32
M40 x 1.5	silver	-	46.00	-	-	5.00	50.00	M40

Ordering data		
Type	Order No.	Pcs./Pkt.
A-INL-M20-N-S	1411242	100
A-INL-M25-N-S	1411243	100
A-INL-M32-N-S	1411244	100
A-INL-M40-N-S	1411246	50

Installation and mounting material

Cable glands

Plastic cable glands with strain relief, metric, EN 60423

- Material: polyamide
- Cable seal: EPDM
- Ambient temperature: -20°C ... +100°C
- Degree of protection: IP68/IP69

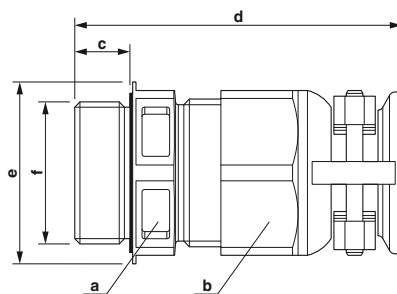

Plastic cable gland with strain relief

Notes:

For counter nuts, see page 686

Thread type	Color	Clamping area [mm]
M20 x 1.5	jet black	6.00 - 13.00
M25 x 1.5	jet black	9.00 - 17.00
M32 x 1.5	jet black	13.00 - 21.00

Dimensions [mm]					Thread
a	b	c	d	e	f
24.00	24.00	10.00	49.00	27.00	M20
29.00	29.00	10.00	51.00	32.00	M25
36.00	36.00	12.00	57.00	40.00	M32

Ordering data

Type	Order No.	Pcs./Pkt.
G-INTRO-M20-S68N-PEPDS-BK	1415189	10
G-INTRO-M25-M68N-PEPDS-BK	1415190	10
G-INTRO-M32-M68N-PEPDS-BK	1415191	5

Brass cable glands with strain relief, metric, EN 60423

- Material: brass, nickel-plated
- Cable seal: EPDM
- O-ring: EPDM
- Ambient temperature: -40°C ... +100°C
- Degree of protection: IP68/IP69

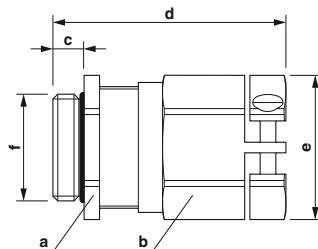

Brass cable gland with strain relief

Notes:

For counter nuts, see page 688

Thread type	Color	Clamping area [mm]
M20 x 1.5	silver	6.00 - 13.00
M25 x 1.5	silver	9.00 - 17.00
M32 x 1.5	silver	13.00 - 21.00
M40 x 1.5	silver	16.00 - 28.00

Dimensions [mm]					Thread
a	b	c	d	e	f
24.00	24.00	6.00	37.00	27.00	M20
29.00	29.00	7.00	42.00	32.00	M25
36.00	36.00	8.00	45.00	40.00	M32
46.00	46.00	8.00	54.00	51.00	M40

Ordering data

Type	Order No.	Pcs./Pkt.
G-INESR-M20-S68N-NEPDS-S	1415192	5
G-INESR-M25-M68N-NEPDS-S	1415193	5
G-INESR-M32-M68N-NEPDS-S	1415194	1
G-INESR-M40-M68N-NEPDS-S	1415195	1

Brass cable glands with bend protection and strain relief, metric, EN 60423

- Material: brass, nickel-plated
- Cable seal: NBR
- O-ring: NBR
- Ambient temperature: -30°C ... +80°C
- Degree of protection: IP65

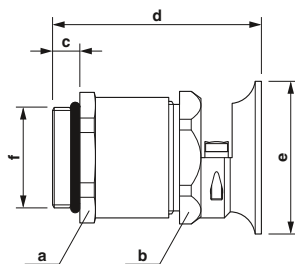

Brass cable gland with cable bend protection and strain relief

Notes:
For counter nuts, see page 688

Thread type	Color	Clamping area [mm]
M20 x 1.5	silver	7.50 - 15.00
M25 x 1.5	silver	10.00 - 19.00
M32 x 1.5	silver	18.00 - 27.00

Dimensions [mm]					Thread
a	b	c	d	e	f
24.00	24.00	6.00	40.00	32.00	M20
30.00	30.00	7.00	44.00	38.00	M25
41.00	40.00	8.00	51.00	50.00	M32

Ordering data		
Type	Order No.	Pcs./Pkt.
HC-M-KV-T-M20	1646188	10
HC-M-KV-T-M25	1646191	10
HC-M-KV-T-M32	1646201	10

Brass cable glands with strain relief clamp, metric, EN 60423

- Material: brass, nickel-plated
- Cable seal: NBR
- O-ring: NBR
- Ambient temperature: -30°C ... +80°C
- Degree of protection: IP65

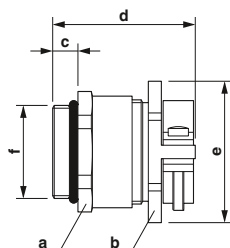

Brass cable gland with strain relief clamp

Notes:
For counter nuts, see page 688

Thread type	Color	Clamping area [mm]
M32 x 1.5	silver	18.00 - 27.00
M40 x 1.5	silver	24.00 - 33.00

Dimensions [mm]					Thread
a	b	c	d	e	f
42.00	40.00	8.00	43.00	47.00	M32
52.00	50.00	8.00	49.00	56.00	M40

Ordering data		
Type	Order No.	Pcs./Pkt.
HC-M-KV-Z-M32	1646162	10
HC-M-KV-Z-M40	1646175	10

Installation and mounting material

Cable glands

Plastic reducing adapters, metric, EN 60423

- Material: polyamide
- Flat gasket: CR
- Ambient temperature: -20°C ... +100°C

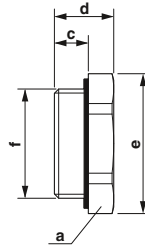

Plastic reducing adapter

Thread type	Color	Clamping area [mm]	Dimensions [mm]					Thread	Ordering data		
			a	b	c	d	e		Type	Order No.	Pcs./Pkt.
M25 x 1.5 / M20 x 1.5	black	-	-	-	8.00	14.00	32.00	M25 / M20	REDUC-K-KV-M25/M20 BK	1411232	10
M32 x 1.5 / M20 x 1.5	black	-	-	-	10.00	16.00	40.00	M32 / M20	REDUC-K-KV-M32/M20 BK	1410725	10
M32 x 1.5 / M25 x 1.5	black	-	-	-	10.00	16.00	40.00	M32 / M25	REDUC-K-KV-M32/M25 BK	1410712	10
M40 x 1.5 / M25 x 1.5	black	-	-	-	10.00	16.00	50.50	M40 / M25	REDUC-K-KV-M40/M25 BK	1410741	10
M40 x 1.5 / M32 x 1.5	black	-	-	-	10.00	16.00	50.50	M40 / M32	REDUC-K-KV-M40/M32 BK	1410738	10

Brass reducing adapters, metric, EN 60423

- Material: brass, nickel-plated
- O-ring: NBR
- Ambient temperature: -20°C ... +80°C

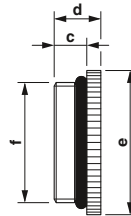

Brass reducing adapter

Thread type	Color	Clamping area [mm]	Dimensions [mm]					Thread	Ordering data		
			a	b	c	d	e		Type	Order No.	Pcs./Pkt.
M20 x 1.5 / M16 x 1.5	silver	-	-	-	6.50	9.00	24.00	M20 / M16	REDUC-M-KV-M20/M16	1647611	10
M25 x 1.5 / M20 x 1.5	silver	-	-	-	7.00	10.00	30.00	M25 / M20	REDUC-M-KV-M25/M20	1647624	10
M32 x 1.5 / M25 x 1.5	silver	-	-	-	8.00	11.50	37.00	M32 / M25	REDUC-M-KV-M32/M25	1647637	10
M40 x 1.5 / M32 x 1.5	silver	-	-	-	8.00	11.50	43.00	M40 / M32	REDUC-M-KV-M40/M32	1647640	10

**Brass reducing adapters,
Pg, EN 40430**

- Material: brass, nickel-plated
- O-ring: NBR
- Ambient temperature:
-20°C ... +80°C

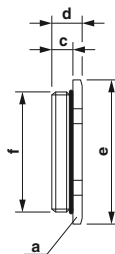

Brass reducing adapter

Thread type	Color	Clamping area [mm]	Dimensions [mm]					Thread
			a	b	c	d	e	
Pg16 / Pg13.5	silver	-	-	-	6.50	9.50	26.70	Pg16 / Pg13.5
Pg21 / Pg16	silver	-	-	-	7.00	10.00	33.50	Pg21 / Pg16
Pg29 / Pg21	silver	-	-	-	8.00	11.50	43.50	Pg29 / Pg21

Ordering data		
Type	Order No.	Pcs./Pkt.
A-INR-PG16/13-N-NS-S	1415216	10
A-INR-PG21/16-N-NS-S	1415217	10
A-INR-PG29/21-N-NS-S	1415218	10

Metal extensions

- Material: brass, nickel-plated
- O-ring: NBR
- Ambient temperature:
-20°C ... +80°C

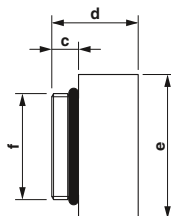

Metal extension adapter

Thread type	Color	Clamping area [mm]	Dimensions [mm]					Thread
			a	b	c	d	e	
M16 x 1.5 / M20 x 1.5	silver	-	-	-	6.00	17.50	22.00	M16 / M20
M20 x 1.5 / M25 x 1.5	silver	-	-	-	6.50	19.00	27.00	M20 / M25
M25 x 1.5 / M32 x 1.5	silver	-	-	-	6.50	21.00	34.00	M25 / M32
M32 x 1.5 / M40 x 1.5	silver	-	-	-	7.00	23.00	42.00	M32 / M40
Pg13.5 / Pg16	silver	-	-	-	6.50	19.00	24.00	Pg13.5 / Pg16
Pg16 / Pg21	silver	-	-	-	6.50	21.00	30.00	Pg16 / Pg21
Pg21 / Pg29	silver	-	-	-	7.00	23.00	39.00	Pg21 / Pg29

Ordering data		
Type	Order No.	Pcs./Pkt.
ENLAR-M-KV-M16/M20	1647653	10
ENLAR-M-KV-M20/M25	1647666	10
ENLAR-M-KV-M25/M32	1647679	10
ENLAR-M-KV-M32/M40	1647682	10
A-INE-PG13/16-N-NS-S	1415219	10
A-INE-PG16/21-N-NS-S	1415220	10
A-INE-PG21/29-N-NS-S	1415221	10

Installation and mounting material

Cable glands

Plastic screw plugs, metric, EN 60423

- Material: polyamide, fiberglass reinforced
- O-ring: EPDM
- Ambient temperature: -40°C ... +100°C
- Degree of protection: IP66/IP68

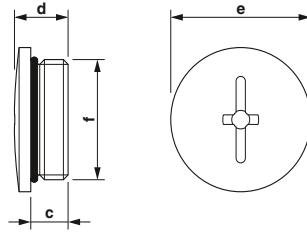

Plastic screw plugs

Thread type	Clamping area [mm]	Dimensions [mm]					Thread
		a	b	c	d	e	
M12 x 1.5	-	-	-	6.00	8.00	15.00	M12
M16 x 1.5	-	-	-	6.00	9.00	20.00	M16
M20 x 1.5	-	-	-	6.00	9.50	24.00	M20
M25 x 1.5	-	-	-	8.00	11.50	30.00	M25
M32 x 1.5	-	-	-	8.00	12.00	37.00	M32
M40 x 1.5	-	-	-	8.00	13.00	46.00	M40

Ordering data			
Order No.	Pcs./Pkt.	Order No.	Pcs./Pkt.
light gray		black	
1045815	10	1045816	10
1045818	10	1045817	10
1424519	10	1415206	10
1424520	10	1415207	10
1424521	10	1415208	10
1424522	5	1415210	5

Brass screw plugs, metric, EN 60423

- Material: brass, nickel-plated
- O-ring: NBR
- Ambient temperature: -20°C ... +80°C
- Degree of protection: IP68

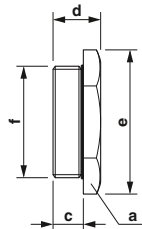

Metal screw plug

Thread type	Color	Clamping area [mm]	Dimensions [mm]					Thread
			a	b	c	d	e	
M12 x 1.5	silver	-	14.00	-	5.00	7.50	14.00	M12
M16 x 1.5	silver	-	18.00	-	5.00	8.00	20.00	M16
M20 x 1.5	silver	-	22.00	-	6.00	9.00	24.00	M20
M25 x 1.5	silver	-	28.00	-	6.50	10.00	31.50	M25
M32 x 1.5	silver	-	35.00	-	7.00	10.50	39.00	M32
M40 x 1.5	silver	-	44.00	-	8.00	12.00	50.00	M40

Ordering data		
Type	Order No.	Pcs./Pkt.
HC-M-BS-M12	1046636	10
HC-M-BS-M16	1646227	10
HC-M-BS-M20	1645846	10
HC-M-BS-M25	1645859	10
HC-M-BS-M32	1645862	10
HC-M-BS-M40	1645875	10

**Plastic screw plugs,
Pg, EN 40430**

- Material: polyamide, fiberglass reinforced
- O-ring: EPDM
- Ambient temperature:
-40°C ... +100°C
- Degree of protection: IP65

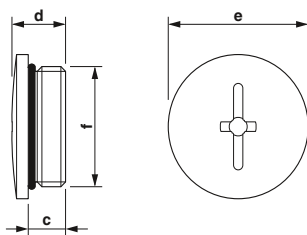

Plastic screw plugs

Thread type	Clamping area [mm]	Dimensions [mm]					Thread f
		a	b	c	d	e	
Pg7	-	-	-	6.00	8.00	15.00	Pg7
Pg9	-	-	-	6.00	9.00	19.00	Pg9
Pg11	-	-	-	6.00	9.00	22.00	Pg11
Pg13.5	-	-	-	6.00	9.50	25.00	Pg13.5
Pg16	-	-	-	6.00	9.50	27.00	Pg16
Pg21	-	-	-	8.00	11.00	33.00	Pg21
Pg29	-	-	-	8.00	12.00	44.00	Pg29

Ordering data			
Order No.	Pcs./Pkt.	Order No.	Pcs./Pkt.
light gray		black	
1047562	10	1047561	10
1047273	10	1047272	10
1047270	10	1047271	10
1046792	10	1046790	10
1424523	10	1415213	10
1424524	10	1415214	10
1424525	10	1415215	10

**Brass screw plugs,
Pg, EN 40430**

- Material: brass, nickel-plated
- O-ring: NBR
- Ambient temperature:
-20°C ... +80°C
- Degree of protection: IP68

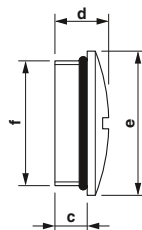

Metal screw plug

Thread type	Color	Clamping area [mm]	Dimensions [mm]					Thread f
			a	b	c	d	e	
Pg7	silver	-	-	-	5.00	7.50	15.00	Pg7
Pg9	silver	-	-	-	5.00	8.00	18.00	Pg9
Pg11	silver	-	-	-	4.50	8.00	22.00	Pg11
Pg13.5	silver	-	-	-	6.00	10.00	24.00	Pg13.5
Pg16	silver	-	-	-	6.00	10.00	26.00	Pg16
Pg21	silver	-	-	-	7.00	11.00	30.00	Pg21
Pg29	silver	-	-	-	7.00	12.00	39.00	Pg29
Pg36	silver	-	-	-	8.00	13.00	50.00	Pg36

Ordering data		
Type	Order No.	Pcs./Pkt.
HC-BS-PG7	1046670	10
HC-BS-PG9	1046669	10
HC-BS-PG11	1674493	10
HC-BS-PG13	1674503	10
HC-BS-PG16	1674516	10
HC-BS-PG21	1674529	10
HC-BS-PG29	1674532	10
HC-BS-PG36	1674545	10

Installation and mounting material

Cable glands

Brass cable glands for one AS-Interface flat cable, metric, EN 60423

- Material: brass, nickel-plated
- Cable seal: TPE
- O-ring: NBR
- Ambient temperature:
-20°C ... +100°C
- Degree of protection: IP65

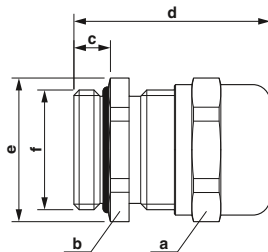

Brass cable gland

Thread type	Color	Clamping area [mm]	Dimensions [mm]					Thread
			a	b	c	d	e	
M20 x 1.5	silver	-	22.00	22.00	6.00	33.50	24.00	M20
M25 x 1.5	silver	-	27.00	27.00	7.00	36.50	36.00	M25

Ordering data		
Type	Order No.	Pcs./Pkt.
HC-M-KV-M20(1ASI)	1584017	10
HC-M-KV-M25(1ASI)	1584020	10

Brass counter nuts, metric, EN 60423

- Material: brass, nickel-plated
- Ambient temperature:
-70°C ... +220°C

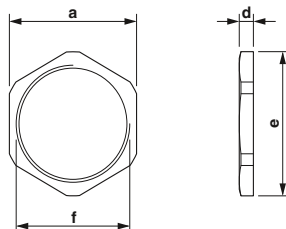

Brass counter nut

Thread type	Color	Clamping area [mm]	Dimensions [mm]					Thread
			a	b	c	d	e	
M20 x 1.5	silver	-	24.00	-	-	3.00	27.00	M20
M25 x 1.5	silver	-	30.00	-	-	3.50	33.50	M25

Ordering data		
Type	Order No.	Pcs./Pkt.
A-INL-M20-N-S	1411242	100
A-INL-M25-N-S	1411243	100

Brass cable glands with seal, metric, EN 60423

- Seal with 10 mm and 11 mm drill hole
- Material: brass, nickel-plated
- Cable seal: TPE
- O-ring: NBR
- Ambient temperature: -20°C ... +100°C
- Degree of protection: IP65

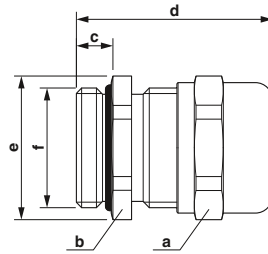

Brass cable gland

Thread type	Color	Clamping area [mm]	Dimensions [mm]					Thread
			a	b	c	d	e	
M25 x 1.5	silver	9.50 - 10.00	34.00	34.00	7.00	37.00	36.00	M25

Ordering data		
Type	Order No.	Pcs./Pkt.
HC-M-KV-M25(1X10/1X11)	1580228	10

Brass counter nuts, metric, EN 60423

- Material: brass, nickel-plated
- Ambient temperature: -70°C ... +220°C

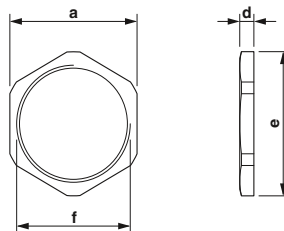

Brass counter nut

Thread type	Color	Clamping area [mm]	Dimensions [mm]					Thread
			a	b	c	d	e	
M25 x 1.5	silver	-	30.00	-	-	3.50	33.50	M25

Ordering data		
Type	Order No.	Pcs./Pkt.
A-INL-M25-N-S	1411243	100

Installation and mounting material

Cable glands

Plastic cable glands for pre-assembled RJ45 cable, metric, EN 60423

- Material: polyamide
- Cable seal: CR
- Ambient temperature: -20°C ... +100°C
- Degree of protection: IP66
- Strain relief: integrated

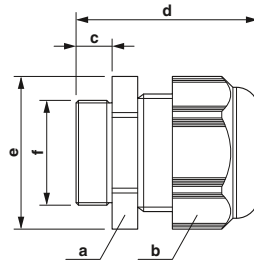

Plastic cable gland

Notes:

For counter nuts, see page 686

			Ordering data								
Thread type	Color	Clamping area [mm]	Dimensions [mm]					Thread	Type	Order No.	Pcs./Pkt.
			a	b	c	d	e	f			
M25 x 1.5	black	3.00 - 7.00	33.00	33.00	10.00	47.00	37.40	M25	G-CCS-M25-M66N-PNES-BK	1076600	10

Brass cable glands, panel feed-throughs for data connectors

- Screw connection material: brass, nickel-plated
- Pressure screw material: brass, nickel-plated
- O-ring: NBR
- Ambient temperature: -40°C ... +125°C
- Degree of protection: IP65

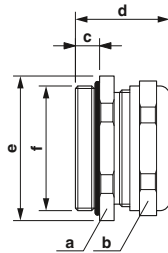

Brass cable gland with split seal

			Ordering data								
Thread type	Color	Clamping area [mm]	Dimensions [mm]					Thread	Type	Order No.	Pcs./Pkt.
			a	b	c	d	e	f			
M50	silver	7.50 - 8.00	50.00	54.00	10.00	39.00	58.00	M50	KV-M-M50-GD-(8)	1636509	5
M50	silver	9.50 - 10.00	50.00	54.00	10.00	39.00	58.00	M50	KV-M-M50-GD-(10)	1636512	5
M50	silver	5.50 - 6.00	50.00	54.00	10.00	39.00	58.00	M50	KV-M-M50-GD-(2X6)	1636525	5
M50	silver	8.50 - 9.00	50.00	54.00	10.00	39.00	58.00	M50	KV-M-M50-GD-(2X9)	1636538	5

Sealing plugs

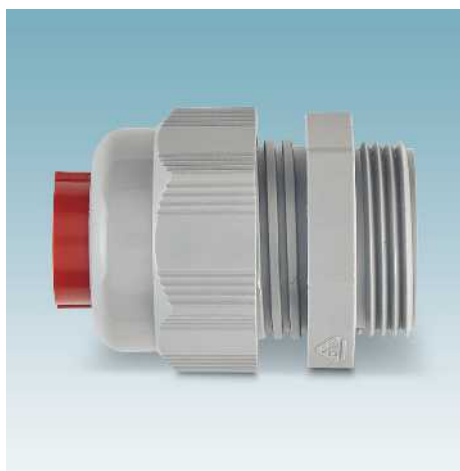

For sealing unused bore holes in multiple grommets and cable glands.

General data	
Material	PA
Ambient temperature (operation)	-60°C ... 100°C

Technical data	
----------------	--

Ordering data		
---------------	--	--

Description	Color	Type	Order No.	Pcs./Pkt.
Closing cap				
Ø 3 mm		SEALING PLUG 3X12 RD	1400238	10
Ø 5 mm		SEALING PLUG 5X12 RD	1400253	10
Ø 6 mm		SEALING PLUG 6X16 RD	1400254	10
Ø 7 mm		SEALING PLUG 7X16 RD	1400255	10
Ø 8 mm		SEALING PLUG 8X16 RD	1400257	10
Ø 9 mm		SEALING PLUG 9X16 RD	1400259	10
Ø 10 mm		SEALING PLUG 10X16 RD	1400284	10
Ø 12 mm		SEALING PLUG 12X22 RD	1400260	10
Ø 13 mm		SEALING PLUG 13X22 RD	1400265	10
Ø 14 mm		SEALING PLUG 14X22 RD	1400270	10
Ø 17 mm		SEALING PLUG 17X17 RD	1421861	10
Ø 20 mm		SEALING PLUG 20X22 RD	1421862	10
Ø 25 mm		SEALING PLUG 25X30 RD	1421863	10
Ø 28 mm		SEALING PLUG 28X30 RD	1421864	10
Ø 35 mm		SEALING PLUG 35X35 RD	1421865	10
Ø 48 mm		SEALING PLUG 48X35 RD	1425357	5

Installation and mounting material

Service interfaces

EMC mounting frames

– Cover, transparent



EMC mounting frame
for one data front plate



EMC mounting frame
for two data front plates

Technical data
Housing material
Flammability rating in accordance with UL 94
Degree of protection
Ambient temperature (operation)

Zinc alloy
V0
IP65
-10°C ... 60°C

Zinc alloy
V0
IP65
-10°C ... 60°C

Ordering data

Description

Mounting frame, with metal frame, matt nickel-plated, electrically conductive, transparent cover

for one data front plate
for two data front plates

Control cabinet key, for all popular control cabinets, closures: 5, 6, 7 - 8 mm, square, 7 - 8 mm triangle, 3-5 mm two-way key bit

Type	Order No.	Pcs./Pkt.
VS-SI-EB-EMV-1	1656482	1
USS 4	1203149	1

Ordering data

Type	Order No.	Pcs./Pkt.
VS-SI-EB-EMV-2	1656495	1
USS 4	1203149	1

Mounting frames

– Cover, transparent



Mounting frame
for one data front plate



Mounting frame
for two data front plates

Technical data
Housing material
Flammability rating in accordance with UL 94
Degree of protection
Ambient temperature (operation)

PBT
V0
IP65
-30°C ... 70°C

PBT
V0
IP65
-30°C ... 70°C

Ordering data

Description

Mounting frame, with plastic frame, black, PC plastic cover, transparent, closure with 3 mm double bit or with enclosed knob

for one data front plate
for two data front plates

Type	Order No.	Pcs./Pkt.
SI-M1A	1404493	1

Ordering data

Type	Order No.	Pcs./Pkt.
SI-M1B	1404494	1

Data front plates



Front plate



Front plate

Technical data
Material front plate
Degree of protection
Ambient temperature (operation)

PBT
IP20
-10°C ... 60°C

PBT
IP20
-10°C ... 60°C

Technical data

Technical data

Ordering data

Ordering data

Description
Data front plate , with the following contact inserts: 2x RJ45 CAT5e (female to female)
Data front plate , unequipped, for accommodating the following contact inserts: 2x RJ (with shroud)
Data front plate , with the following contact inserts: 1x RJ45 CAT5e, 1x D-SUB 9 BP

Type	Order No.	Pcs./Pkt.
VS-SI-FP-2RJ45-5-MOD-BU/BU	1657766	1
VS-SI-FP-2RJ-MOD	1656631	1

Type	Order No.	Pcs./Pkt.
SI-FP-R1A-D1E	1404500	1

Data front plates



Front plate



Front plate

Technical data
Material front plate
Degree of protection
Ambient temperature (operation)

PBT
IP20
-10°C ... 60°C

PBT
IP20
-10°C ... 60°C

Technical data

Technical data

Ordering data

Ordering data

Description
Data front plate , with the following contact inserts: 1x RJ45 CAT5e, 1x D-SUB 9
Data front plate , with the following contact inserts: 1x D-SUB 9

Type	Order No.	Pcs./Pkt.
SI-FP-R1A-D1A	1404496	1

Type	Order No.	Pcs./Pkt.
SI-FP-D1A	1404501	1

Installation and mounting material

Service interfaces

Data front plates



Front plate



Front plate

Technical data
Material front plate
Degree of protection
Ambient temperature (operation)

Technical data		
PBT		
IP20		
-10°C ... 60°C		

Technical data		
PBT		
IP20		
-10°C ... 60°C		

Description

Data front plate, with the following contact inserts:

1x RJ45 CAT5e, 1x USB A 3.0 with 0.7 m cable

Data front plate, with the following contact inserts:

1x RJ45 CAT5e, 1x USB A 3.0 with 0.7 m cable, 1x D-SUB 9

Ordering data		
Type	Order No.	Pcs./Pkt.
SI-FP-R1A-U1A/0,7	1404512	1

Ordering data		
Type	Order No.	Pcs./Pkt.
SI-FP-R1A-D1B-U1A/0,7	1404504	1

Data front plates



Front plate



Front plate

Technical data
Material front plate
Degree of protection
Ambient temperature (operation)

Technical data		
PBT		
IP20		
-10°C ... 60°C		

Technical data		
PBT		
IP20		
-10°C ... 60°C		

Description

Data front plate, with the following contact inserts:

1x RJ45 CAT5e (female to female), 1x USB A 3.0 (female to female), 1x D-SUB 9 (female to female)

Data front plate, with the following contact inserts:

2x D-SUB 9

Ordering data		
Type	Order No.	Pcs./Pkt.
SI-FP-R1A-U1A-D1A	1404497	1

Ordering data		
Type	Order No.	Pcs./Pkt.
VS-SI-FP-2DSUB9-GC-BU/ST	1657708	1

Data front plates



Front plate



Front plate

Technical data

Technical data
Material front plate
Degree of protection
Ambient temperature (operation)

PBT
IP20
-10°C ... 60°C

Technical data

PBT
IP20
-10°C ... 60°C

Ordering data

Type	Order No.	Pcs./Pkt.
SI-FP-R1A-U1A	1404499	1

Ordering data

Type	Order No.	Pcs./Pkt.
SI-FP-2R1A-U1A	1404506	1

Description
Data front plate , with the following contact inserts: 1x RJ45 CAT5e, 1x USB A 3.0
Data front plate , with the following contact inserts: 2x RJ45 CAT5e, 1x USB A 3.0

Data front plates



Front plate

Technical data

Technical data
Material front plate
Degree of protection
Ambient temperature (operation)

-
IP20
-10°C ... 60°C

Ordering data

Type	Order No.	Pcs./Pkt.
VS-SI-FP-BP	1656657	1

Description
Data front plate , without contact inserts

Installation and mounting material

Service interfaces

Data front plates



Front plate



Front plate

Technical data
Material front plate
Degree of protection
Ambient temperature (operation)

PBT
-
-10°C ... 60°C

PBT
-
-10°C ... 60°C

Technical data

Technical data

Ordering data

Ordering data

Description

Data front plate, unequipped, for accommodating the following contact inserts:

2x D-SUB 9
2x D-SUB 15
2x D-SUB 25

Data front plate, unequipped, for accommodating the following contact inserts:

1x D-SUB 9, 1x D-SUB 15
1x D-SUB 9, 1x D-SUB 25
1x D-SUB 15, 1x D-SUB 25

Type	Order No.	Pcs./Pkt.
VS-SI-FP-2DSUB9	1656563	1
VS-SI-FP-2DSUB15	1656592	1
VS-SI-FP-2DSUB25	1656615	1

Type	Order No.	Pcs./Pkt.
VS-SI-FP-DSUB9-DSUB15	1656576	1
VS-SI-FP-DSUB9-DSUB25	1656589	1
VS-SI-FP-DSUB15-DSUB25	1656602	1

Inserts for data front plates



Gender changer

Technical data
Housing material
Degree of protection
Ambient temperature (operation)

Steel, yellow chromated
-
-55°C ... 125°C

Technical data

Ordering data

Description

D-SUB gender changer

9-pos., female/female
15-pos., female/female
25-pos., female/female

Type	Order No.	Pcs./Pkt.
VS-09-GC-BU/BU	1688722	10
VS-15-GC-BU/BU	1652664	10
VS-25-GC-BU/BU	1652680	10

Data front plates



Front plate



Front plate

Technical data
Material front plate
Degree of protection
Ambient temperature (operation)

Technical data		
Zinc die-cast, nickel-plated		
IP20 / IP00		
-5°C ... 50°C		

Technical data		
Zinc die-cast, nickel-plated		
IP20 / IP00		
-5°C ... 50°C		

Description
Data front plate, with grounding contact socket for Germany, including RJ45 gender changer (female/female, shielded), CAT6_A

Spring connection
Data front plate, with grounding contact socket for France, including RJ45 gender changer (female/female, shielded), CAT6_A

Screw connection

Ordering data		
Type	Order No.	Pcs./Pkt.
VS-FP-SD-D-RJ456A-BUBU	1054542	1

Ordering data		
Type	Order No.	Pcs./Pkt.
VS-FP-SD-FR-RJ456A-BUBU	1054543	1

Data front plates and accessories



Front plate



Gender changer, ground strap

Technical data
Material front plate
Degree of protection
Ambient temperature (operation)

Technical data		
Zinc die-cast, nickel-plated		
IP20 / IP00		
-5°C ... 50°C		

Technical data		
-		
IP20		
-40°C ... 70°C		

Description
Data front plate, with grounding contact socket for England, including RJ45 gender changer (female/female, shielded), CAT6_A

Screw connection
Gender changer
RJ45 CAT6_A, female/female shielded
USB 3.0, design: A, female/female
Ground strap, for functional ground

Ordering data		
Type	Order No.	Pcs./Pkt.
VS-FP-SD-GB-RJ456A-BUBU	1054544	1

Ordering data		
Type	Order No.	Pcs./Pkt.
VS-GC-RJ456A-BUBU	1055552	1
VS-GC-USBA3-A-BUBU	1055554	1
VS-ES-100-6	1055164	1

Service interfaces

Control cabinet sockets



Sockets that can be mounted on DIN rails serve for easy connection of electrical auxiliary devices for assembly, testing, lighting, etc. They enable worldwide use in switchgear, control cabinets, and in simple sub-distributions. Worldwide use makes it essential to offer the sockets with pin connector patterns that are standard in each country, in accordance with the currently applicable standards and regulations. The mounting holes in the sockets mean that, in addition to mounting on a DIN rail in accordance with EN 60715, there is also the option of direct mounting in the service interface. The EO sockets are offered with both the proven screw connection, as well as the modern Push-in connection. The integrated functions such as LED, fuse, switch, circuit breaker or a combination of the functions with each other, offers a wide area of use.

L1, N, and PE are arranged on one side of the socket depending on the connection. You can select the following pin connector patterns for the sockets:

- Type AB, type CF, type D, type E, type G, type I, type J, type K, type L, and type N
- Type E, type G, and type L are also supplied with an integrated shutter system
- The USA versions are offered with integrated circuit breaker in 15 A and 20 A
- Housing color: gray or green

In combination with the EO-SI-FRAME adapter plate, the sockets can also be used in the VS-SI-... / SI-... mounting frames under different IP protection classes.

Notes:

To install a control cabinet socket in a VS-SI-... or SI-... mounting frame, you will need an EO-SI-FRAME adapter plate (see accessories).



Individual socket, Germany,
Push-in connection



Technical data

Nominal voltage	250 V AC (50 Hz)
Max. continuous current	16 A
General data	EO...
Dimensions	W / H / D 45 mm / 75 mm / 60 mm
Connection data rigid/flexible/AWG	0.2 - 4 mm ² / 0.2 - 2.5 mm ² / 24 - 12
Degree of protection	IP20
Insulation material	PA
Ambient temperature range	-20°C ... 60°C
Standards/regulations	VDE 0620-1
Flammability rating in accordance with UL 94	V0

Ordering data

Description	Type	Order No.	Pcs./Pkt.
Sockets for the DIN rail, Push-in connection			
Default, gray	EO-CF/PT	0804038	5
Default, green	EO-CF/PT/GN	0804039	5
Standard, yellow	EO-CF/PT/YE	1068067	5
LED display, gray	EO-CF/PT/LED	0804040	5
LED display, green	EO-CF/PT/LED/GN	0804041	5
LED display, yellow	EO-CF/PT/LED/YE	1068075	5
LED display and fuse 5 x 20 mm, 6.3 A, gray	EO-CF/PT/LED/F	0804042	5
LED display and fuse 5 x 20 mm, 6.3 A, green	EO-CF/PT/LED/F/GN	0804043	5
Switch, gray	EO-CF/PT/S	0804045	5
Switch, LED display, gray	EO-CF/PT/LED/S	0804046	5
Fuse 5 x 20 mm, 6.3 A, gray	EO-CF/PT/F	0804047	5
Fuse 5 x 20 mm, 6.3 A, green	EO-CF/PT/F/GN	0804048	5
Socket for the DIN rail, screw connection			
Default, gray	EO-CF/UT	0804024	5
Default, green	EO-CF/UT/GN	0804025	5
Standard, yellow	EO-CF/UT/YE	1068038	5
LED display, gray	EO-CF/UT/LED	0804026	5
LED display, green	EO-CF/UT/LED/GN	0804027	5
LED display, yellow	EO-CF/UT/LED/YE	1068028	5
LED display and fuse 5 x 20 mm, 6.3 A, gray	EO-CF/UT/LED/F	0804029	5
LED display and fuse 5 x 20 mm, 6.3 A, green	EO-CF/UT/LED/F/GN	0804030	5
Switch, gray	EO-CF/UT/S	0804032	5
Switch, LED display, gray	EO-CF/UT/LED/S	0804033	5
Fuse 5 x 20 mm, 6.3 A, gray	EO-CF/UT/F	0804034	5
Fuse 5 x 20 mm, 6.3 A, green	EO-CF/UT/F/GN	0804035	5

Accessories

Adapter plate, for installing a control cabinet socket in a mounting frame, version:	Type	Order No.	Pcs./Pkt.
VS-SI-... or SI-...	EO-SI-FRAME	0804522	1
UniCard, for terminal blocks with a flat marker groove, 64-section, 7 individual labels per strip, for a terminal block width of 8.2 mm	UC-TMF 8	0818137	10
UniCard, for terminal blocks with a flat marker groove, 32-section, 4 individual labels per strip, for a terminal block width of 16 mm	UC-TMF 16	0819262	10
Zack marker strip, flat, 10-section, without color print	ZBF 8:UNBEDRUCKT	0808781	10
Zack marker strip, flat, 5-section, without color print	ZBF 16:UNPRINTED	0827464	10



Individual socket, USA,
Push-in connection



Individual socket, India, Africa,
Push-in connection

Technical data
125 V AC (60 Hz)
15 A
EO-...
45 mm / 75 mm / 57.5 mm
0.2 - 4 mm ² / 0.2 - 2.5 mm ² / 24 - 12
IP20
PA
-20°C ... 60°C
UL 508
V0

Technical data
250 V AC (50 Hz)
6 A
EO-...
45 mm / 75 mm / 57.5 mm
0.2 - 4 mm ² / 0.2 - 2.5 mm ² / 24 - 12
IP20
PA
-20°C ... 60°C
IS 1293
V0

Ordering data		
Type	Order No.	Pcs./Pkt.
EO-AB/PT/15	0804165	5
EO-AB/PT/LED/15	0804168	5
EO-AB/PT/LED/F	0804171	5
EO-AB/PT/S/15	0804173	5
EO-AB/PT/LED/S/15	0804174	5
EO-AB/PT/F	0804175	5
EO-AB/UT/15	0804152	5
EO-AB/UT/LED/15	0804155	5
EO-AB/UT/LED/F	0804157	5
EO-AB/UT/S/15	0804159	5
EO-AB/UT/LED/S/15	0804160	5
EO-AB/UT/F	0804161	5

Ordering data		
Type	Order No.	Pcs./Pkt.
EO-D/PT	0804009	5
EO-D/PT/GN	0804010	5
EO-D/PT/LED	0804011	5
EO-D/PT/LED/GN	0804012	5
EO-D/UT	0804000	5
EO-D/UT/GN	0804001	5
EO-D/UT/LED	0804003	5
EO-D/UT/LED/GN	0804004	5
EO-D/UT/F	0804005	5
EO-D/UT/F/GN	0804006	5

Accessories		
Type	Order No.	Pcs./Pkt.
EO-SI-FRAME	0804522	1
UC-TMF 8	0818137	10
UC-TMF 16	0819262	10
ZBF 8:UNBEDRUCKT	0808781	10
ZBF 16:UNPRINTED	0827464	10

Accessories		
Type	Order No.	Pcs./Pkt.
EO-SI-FRAME	0804522	1
UC-TMF 8	0818137	10
UC-TMF 16	0819262	10
ZBF 8:UNBEDRUCKT	0808781	10
ZBF 16:UNPRINTED	0827464	10

Service interfaces

Control cabinet sockets



To prevent unintentional contact with live components, the type E, G, and L sockets have integrated touch protection (child-proofing). This is enshrined in the respective country standards, such as NF C61-314.

In combination with the EO-SI-FRAME adapter plate, the sockets can also be used in the VS-SI-... / SI-... mounting frames under different IP protection classes.

Notes:

To install a control cabinet socket in a VS-SI-... or SI-... mounting frame, you will need an EO-SI-FRAME adapter plate (see accessories).



Individual socket, Italy,
Push-in connection with shutter



Technical data

Nominal voltage	250 V AC (50 Hz)
Max. continuous current	16 A
General data	EO-...
Dimensions	W / H / D 45 mm / 75 mm / 57.5 mm
Connection data rigid/flexible/AWG	0.2 - 4 mm ² / 0.2 - 2.5 mm ² / 24 - 12
Degree of protection	IP20
Insulation material	PA
Ambient temperature range	-20°C ... 60°C
Standards/regulations	CEI 23-50
Flammability rating in accordance with UL 94	V0

Ordering data

Description	Color	Type	Order No.	Pcs./Pkt.
Sockets for the DIN rail, Push-in connection				
Default, gray		EO-L/PT/SH	0804132	5
Default, green		EO-L/PT/SH/GN	0804133	5
LED display, gray		EO-L/PT/SH/LED	0804134	5
LED display, green		EO-L/PT/SH/LED/GN	0804135	5
Switch, gray				
Switch, LED display, gray				
Socket for the DIN rail, screw connection				
Default, gray		EO-L/UT/SH	0804126	5
Default, green		EO-L/UT/SH/GN	0804127	5
LED display, gray		EO-L/UT/SH/LED	0804128	5
LED display, green		EO-L/UT/SH/LED/GN	0804129	5
Switch, gray				
Switch, LED display, gray				

Accessories

Description	Color	Type	Order No.	Pcs./Pkt.
Adapter plate, for installing a control cabinet socket in a mounting frame, version:				
VS-SI-... or SI-...		EO-SI-FRAME	0804522	1
UniCard , for terminal blocks with a flat marker groove, 64-section, 7 individual labels per strip, for a terminal block width of 8.2 mm	white	UC-TMF 8	0818137	10
UniCard , for terminal blocks with a flat marker groove, 32-section, 4 individual labels per strip, for a terminal block width of 16 mm	white	UC-TMF 16	0819262	10
Zack marker strip, flat, 10-section, without color print	white	ZBF 8:UNBEDRUCKT	0808781	10
Zack marker strip, flat, 5-section, without color print	white	ZBF 16:UNPRINTED	0827464	10



Individual socket, France,
Push-in connection with shutter



Individual socket, Great Britain,
Push-in connection with shutter



Technical data	
250 V AC (50 Hz)	
16 A	
EO-...	
45 mm / 75 mm / 57.5 mm	
0.2 - 4 mm ² / 0.2 - 2.5 mm ² / 24 - 12	
IP20	
PA	
-20°C ... 60°C	
NF C61-314	
V0	

Technical data	
250 V AC (50 Hz)	
13 A	
EO-...	
45 mm / 75 mm / 57.5 mm	
0.2 - 4 mm ² / 0.2 - 2.5 mm ² / 24 - 12	
IP20	
PA	
-20°C ... 60°C	
BS 1363-1/-2	
V0	

Ordering data		
Type	Order No.	Pcs./Pkt.
EO-E/PT/SH	0804020	5
EO-E/PT/SH/GN	0804021	5
EO-E/PT/SH/LED	0804022	5
EO-E/PT/SH/LED/GN	0804023	5
EO-E/UT/SH	0804016	5
EO-E/UT/SH/GN	0804017	5
EO-E/UT/SH/LED	0804018	5
EO-E/UT/SH/LED/GN	0804019	5

Ordering data		
Type	Order No.	Pcs./Pkt.
EO-G/PT/SH	0804063	5
EO-G/PT/SH/GN	0804064	5
EO-G/PT/SH/LED	0804065	5
EO-G/PT/SH/LED/GN	0804066	5
EO-G/PT/SH/S	0804069	5
EO-G/PT/SH/LED/S	0804070	5
EO-G/UT/SH	0804051	5
EO-G/UT/SH/GN	0804052	5
EO-G/UT/SH/LED	0804053	5
EO-G/UT/SH/LED/GN	0804054	5
EO-G/UT/SH/S	0804058	5
EO-G/UT/SH/LED/S	0804059	5

Accessories		
Type	Order No.	Pcs./Pkt.
EO-SI-FRAME	0804522	1
UC-TMF 8	0818137	10
UC-TMF 16	0819262	10
ZBF 8:UNBEDRUCKT	0808781	10
ZBF 16:UNPRINTED	0827464	10

Accessories		
Type	Order No.	Pcs./Pkt.
EO-SI-FRAME	0804522	1
UC-TMF 8	0818137	10
UC-TMF 16	0819262	10
ZBF 8:UNBEDRUCKT	0808781	10
ZBF 16:UNPRINTED	0827464	10

Service interfaces

Control cabinet sockets



The sockets can be operated independently of the control cabinet circuit. In the event of an error, this enables the use of current-operated external measurement devices that are necessary for fault analysis. An LED display advises of the voltage connected to the socket.

In combination with the EO-SI-FRAME adapter plate, the sockets can also be used in the VS-SI-... / SI-... mounting frames under different IP protection classes.

Notes:

To install a control cabinet socket in a VS-SI-... or SI-... mounting frame, you will need an EO-SI-FRAME adapter plate (see accessories).



Individual socket, Brazil, South Africa, Push-in connection

General data	
Nominal voltage	250 V AC (50 Hz ... 60 Hz)
Max. continuous current	20 A
General data	EO-...
Dimensions	W / H / D 45 mm / 75 mm / 57.5 mm
Connection data rigid/flexible/AWG	0.2 - 4 mm ² / 0.2 - 2.5 mm ² / 24 - 12
Degree of protection	IP20
Insulation material	PA
Ambient temperature range	-20°C ... 60°C
Standards/regulations	NBR 14136
Flammability rating in accordance with UL 94	V0

Technical data

Description	Color
Socket for DIN rail, Push-in connection, 10 A	
Default, gray	
Default, green	
LED display, gray	
LED display, green	
Socket for DIN rail, screw connection, 20 A	
Default, gray	
Default, green	
LED display, gray	
LED display, green	

Ordering data

Type	Order No.	Pcs./Pkt.
EO-N/PT	0804146	5
EO-N/PT/GN	0804147	5
EO-N/PT/LED	0804148	5
EO-N/PT/LED/GN	0804149	5
EO-N/UT	0804139	5
EO-N/UT/GN	0804140	5
EO-N/UT/LED	0804142	5
EO-N/UT/LED/GN	0804143	5

Adapter plate, for installing a control cabinet socket in a mounting frame, version:

VS-SI-... or SI-...

UniCard, for terminal blocks with a flat marker groove, 64-section, 7 individual labels per strip, for a terminal block width of 8.2 mm

white

UniCard, for terminal blocks with a flat marker groove, 32-section, 4 individual labels per strip, for a terminal block width of 16 mm

white

Zack marker strip, flat, 10-section, without color print

white

Zack marker strip, flat, 5-section, without color print

white

Accessories

Accessories	Order No.	Pcs./Pkt.
EO-SI-FRAME	0804522	1
UC-TMF 8	0818137	10
UC-TMF 16	0819262	10
ZBF 8:UNBEDRUCKT	0808781	10
ZBF 16:UNPRINTED	0827464	10



Individual socket, China, Australia,
Push-in connection



Individual socket, Switzerland,
Push-in connection



Individual socket, Denmark,
Push-in connection



Technical data	
250 V AC (50 Hz)	
10 A	
EO-...	
45 mm / 75 mm / 57.5 mm	
0.2 - 4 mm ² / 0.2 - 2.5 mm ² / 24 - 12	
IP20	
PA	
-20°C ... 60°C	
GB 2099.1 and GB 1002	
V0	

Technical data	
250 V AC (50 Hz)	
16 A	
EO-...	
45 mm / 75 mm / 57.5 mm	
0.2 - 4 mm ² / 0.2 - 2.5 mm ² / 24 - 12	
IP20	
PA	
-20°C ... 60°C	
SEV 1011	
V0	

Technical data	
250 V AC (50 Hz)	
16 A	
EO-...	
45 mm / 75 mm / 57.5 mm	
0.2 - 4 mm ² / 0.2 - 2.5 mm ² / 24 - 12	
IP20	
PA	
-20°C ... 60°C	
SR 107-2-D1	
V0	

Ordering data		
Type	Order No.	Pcs./Pkt.
EO-I/UT	0804087	5
EO-I/UT/GN	0804088	5
EO-I/UT/LED	0804089	5
EO-I/UT/LED/GN	0804090	5

Ordering data		
Type	Order No.	Pcs./Pkt.
EO-J/PT	0804105	5
EO-J/PT/GN	0804106	5
EO-J/PT/LED	0804107	5
EO-J/PT/LED/GN	0804108	5
EO-J/UT	0804099	5
EO-J/UT/GN	0804100	5
EO-J/UT/LED	0804101	5
EO-J/UT/LED/GN	0804102	5

Ordering data		
Type	Order No.	Pcs./Pkt.
EO-K/PT	0804119	5
EO-K/PT/GN	0804120	5
EO-K/PT/LED	0804121	5
EO-K/PT/LED/GN	0804122	5
EO-K/UT	0804113	5
EO-K/UT/GN	0804114	5
EO-K/UT/LED	0804115	5
EO-K/UT/LED/GN	0804116	5

Accessories		
Type	Order No.	Pcs./Pkt.
EO-SI-FRAME	0804522	1
UC-TMF 8	0818137	10
UC-TMF 16	0819262	10
ZBF 8:UNBEDRUCKT	0808781	10
ZBF 16:UNPRINTED	0827464	10

Accessories		
Type	Order No.	Pcs./Pkt.
EO-SI-FRAME	0804522	1
UC-TMF 8	0818137	10
UC-TMF 16	0819262	10
ZBF 8:UNBEDRUCKT	0808781	10
ZBF 16:UNPRINTED	0827464	10

Accessories		
Type	Order No.	Pcs./Pkt.
EO-SI-FRAME	0804522	1
UC-TMF 8	0818137	10
UC-TMF 16	0819262	10
ZBF 8:UNBEDRUCKT	0808781	10
ZBF 16:UNPRINTED	0827464	10



Service socket

Technical data
Housing material
Ambient temperature (operation)

PA
-40°C ... 70°C

Technical data

Description

Service socket, with the following contact inserts:

RJ45 CAT6_A
USB A 3.0

Ordering data

Type	Order No.	Pcs./Pkt.
SI-RND-R1A	1425186	1
SI-RND-U1A	1425185	1

RJ45 patch cables

Notes:

For accessories, see page: 388

Ethernet



RJ45 patch cable for IP20 applications



Technical data

Cable, properties	
External diameter	
Single wire, material	
Single wires, quantity	
Single wire, cross section	
Outer sheath, material	
Smallest bending radius, fixed installation	
Shielding	
Male connector	
Contact resistance	
General data	
Ambient temperature (operation)	

	FL CAT5 PATCH 0,3	FL CAT6 PATCH 0,3
External diameter	5.50 mm	5.50 mm
Single wire, material	Cu litz wire	Cu litz wire
Single wires, quantity	8	8
Single wire, cross section	0.14 mm ²	0.14 mm ²
Outer sheath, material	LSFROH	LSFROH
Smallest bending radius, fixed installation	30 mm	30 mm
Shielding	SF/UTP	S/FTP
Contact resistance	≤ 0.003 Ω (IEC 60603-7)	≤ 0.003 Ω (IEC 60603-7)
Ambient temperature (operation)	-10°C ... 60°C	-10°C ... 60°C

Ordering data

Description	Length of cable	Type	Order No.	Pcs./Pkt.
Patch cable, CAT5, preassembled				
	0.3 m	FL CAT5 PATCH 0,3	2832250	10
	0.5 m	FL CAT5 PATCH 0,5	2832263	10
	1 m	FL CAT5 PATCH 1,0	2832276	10
	1.5 m	FL CAT5 PATCH 1,5	2832221	10
	2 m	FL CAT5 PATCH 2,0	2832289	10
	3 m	FL CAT5 PATCH 3,0	2832292	10
	5 m	FL CAT5 PATCH 5,0	2832580	10
	7.5 m	FL CAT5 PATCH 7,5	2832616	10
	10 m	FL CAT5 PATCH 10,0	2832629	10
Patch cable, CAT6, preassembled				
	0.3 m	FL CAT6 PATCH 0,3	2891181	10
	0.5 m	FL CAT6 PATCH 0,5	2891288	10
	1 m	FL CAT6 PATCH 1,0	2891385	10
	1.5 m	FL CAT6 PATCH 1,5	2891482	10
	2 m	FL CAT6 PATCH 2,0	2891589	10
	3 m	FL CAT6 PATCH 3,0	2891686	10
	5 m	FL CAT6 PATCH 5,0	2891783	10
	7.5 m	FL CAT6 PATCH 7,5	2891880	10
	10 m	FL CAT6 PATCH 10	2891877	10
	12.5 m	FL CAT6 PATCH 12,5	2891369	5
	15 m	FL CAT6 PATCH 15,0	2891372	5
	20 m	FL CAT6 PATCH 20,0	2891576	5
Patch cable, CAT6_A, pre-assembled, outer sheath color: water blue				
	0.3 m	NBC-R4AC1/0,3-94G/R4AC1-BU	1413158	1
	0.5 m	NBC-R4AC1/0,5-94G/R4AC1-BU	1413159	1
	1 m	NBC-R4AC1/1,0-94G/R4AC1-BU	1413160	1
	2 m	NBC-R4AC1/2,0-94G/R4AC1-BU	1413161	1
	3 m	NBC-R4AC1/3,0-94G/R4AC1-BU	1413162	1
	5 m	NBC-R4AC1/5,0-94G/R4AC1-BU	1413163	1
	10 m	NBC-R4AC1/10,0-94G/R4AC1-BU	1413164	1
	15 m	NBC-R4AC1/15,0-94G/R4AC1-BU	1413165	1
	20 m	NBC-R4AC1/20,0-94G/R4AC1-BU	1413166	1



Cable marking

The cables are supplied with marking collars. The marking is implemented by means of insert strips that can be marked and is protected by the carrier. Subsequent marking is therefore possible.



Distributor box marking

High-quality marking materials are available for the individual marking of distributor boxes.



Connector marking

Marking materials ranging from adhesive labels to high-quality engraved labels are available for marking heavy-duty connectors.



Cable markers

Markers can be fitted using cable binders almost regardless of cable diameter. The large marking area provides enough space for comprehensive marking.



Cable marker labels

Cable marker labels consist of a marking field and a transparent film that protects the marking against abrasion and dirt.



Plastic cable markers

Plastic cable markers are suitable for bundling and marking cables. The marking is protected against dirt and can be replaced.



Cable protection systems

We have the right solution for your application. Select from our comprehensive range of plastic and metal protective hoses. Protective hose screw connections with tool-free quick mounting function and various IP protection classes round off the range of products.

i Your web code: #0572

Find out more with the web code

Detailed information on these products can be found on our website. Simply enter # followed by the numbers in the search field.



Quality in quantity

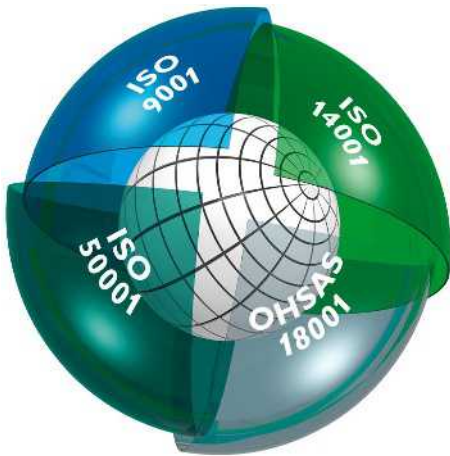

Integrated management system

The objective of the Phoenix Contact integrated management system is to integrate all requirements pertaining to products, processes, and the organization.

Statutory and regulatory requirements, as well as those of international standards and our customers, are met and, in some cases, even exceeded in all phases of the product lifecycle.

The Phoenix Contact management system is monitored by internationally recognized independent bodies each year to ensure that quality, environmental protection, energy efficiency, and occupational safety have been integrated in conformance with the relevant requirements. Certification in accordance with international standards ISO 9001, ISO 14001, ISO 50001, and BS OHSAS 18001 is the result of our corporate philosophy of meeting the needs of our customers, staff, and environment as best as possible. This serves as the basis for innovative products with the familiar high Phoenix Contact quality standard, actively practiced environmental protection through efficient production and products that conserve resources, and responsibility in the field of occupational health and safety. It goes without saying that we integrate all further requirements of standards, international approvals or special customer requirements into our company processes.

The result of this system is a building block for the success of the Phoenix Contact Group as well as its products and services.

CE marking

CE marking was introduced as an important instrument for the free movement of goods and services within the single European market. By applying the mark to a product, the manufacturer confirms its compliance with all EU directives applicable to this product. The EU directives describe the product characteristics with regard to device safety and the avoidance of risks. They have been incorporated in national legislation.

Compliance with the requirements is a **condition for placing the product on the market within the EU.**

Where applicable, our products currently fall within the scope of the following directives in particular:

- 2014/35/EU
Electrical equipment designed for use within certain voltage limits (Low Voltage Directive)
- 2014/30/EU
Electromagnetic compatibility (EMC Directive)
- 2014/32/EU
Measuring instruments
- 2006/42/EC
Safety of machinery (Machinery Directive)
- 2014/34/EU
Equipment and protective systems intended for use in potentially explosive atmospheres (ATEX Directive)
- 2014/53/EU
Radio equipment (RED)
- 2011/65/EU
Restriction of the use of certain hazardous substances (RoHS Directive)
- 2012/19/EU
Waste electrical and electronic equipment (WEEE Directive)

The standards used as the basis for the aforementioned directives have been at the heart of our development standard for some time as a way of ensuring compliance with European directives. The numbers of the directives indicate their version at the time of publication. In the event of changes to directives and/or standards, our products will undergo conformity assessment again in good time and a new declaration of conformity will be issued promptly. The current declarations for each product can also be found in our download area.

Among the aforementioned European directives, the EMC Directive plays a particularly important role. It uses a directive enshrined in national legislation as the basis for defining electromagnetic compatibility as a fundamental device property.

European legislation therefore places great emphasis on the electromagnetic compatibility of devices and systems as a basic prerequisite for the error-free operation of machines and systems. As an international leader in the field of surge protection, Phoenix Contact has extensive expertise in EMC. This expertise and the experience gained over many years in the development and application of industrial interface and communication technology have resulted in an extremely high standard of quality for our products when it comes to electromagnetic compatibility.

Our independent laboratory, Phoenix Testlab, was founded in order to share this expertise with other companies. Phoenix Testlab GmbH

is an accredited service company, which carries out EMC testing in compliance with European standards. At Phoenix Testlab, devices are also tested with regard to their electrical safety, mechanical influences, and their behavior in relation to environmental influences. Phoenix Testlab is also a notified body in accordance with EMC Directive 2014/30/EU and Radio Equipment Directive (RED) 2014/53/EU. As a certification body (TCB, FCB, and RCB), Phoenix Testlab is also able to approve these products for the markets in the USA, Canada, and Japan.

Standards and regulations

All relevant standards and regulations are used as the basis for the development and maintenance of our products.

International standards are subject to continuous changes as a result of harmonization and new developments. In line with this process, the current version of all standards that are relevant to our products is documented in the product area on our website at phoenixcontact.net/products.

Online product information service on the world wide web

Phoenix Contact is continuously extending its product range.

Within the scope of our product monitoring obligation, all products are subject to an improvement process.

The Internet is an ideal platform to quickly communicate new product developments and improvements to the market.

You can quickly access the relevant Phoenix Contact website for your region via phoenixcontact.com. There you will always find an up-to-date overview of products, solutions, and services from Phoenix Contact. This includes technical documents such as data sheets and user manuals, current driver and demo software, and a direct link to the relevant contact person.

Connection cross section

IEC 60947-7-1/-2

The connection capacity for connectors is documented in the technical data. The connection capacity defines the conductor cross section that can be connected for conductors in rigid (single and multi-stranded) or flexible (fine-stranded) versions. Cross section ranges are also specified for the use of ferrules. Furthermore, ranges where two conductors in rigid and flexible versions are to be simultaneously connected are also listed.

Phoenix Contact connectors are designed so that copper wires can be connected untreated. "Special treatment" or the use of ferrules is not required. "Special treatment" includes tin-plating the litz wires of a conductor, using cable lugs, bending the

eyes, etc. However, it does not include straightening the conductor before inserting it into the terminal block or twisting a multi-stranded conductor in order to stabilize the ends.

If ferrules are nevertheless used as splicing protection for flexible conductors, the connection capacity of the flexible conductor is reduced by around one level. Conductors may not be soldered ("soldering all litz wires of a conductor together").

The use of Phoenix Contact CRIMPFOX crimping tools to crimp ferrules is recommended in all cases.

Structure and dimensions of connecting cables

Cross section [mm ²]	Single-stranded		Multi-stranded		Fine-stranded		American Wire Gauge [AWG]						
	Diameter max. dimension	Number of wires	Diameter max. dimension	Number of wires (Minimum number)	Diameter max. dimension	Number of wires (Guide value)	Gauge No.	Rigid wires*			Flexible wires*		
								AWG	[Ø mm]	[circ. mils]	[mm ²]	[Ø mm]	[circ. mils]
0.2	0.5	1	-	-	-	-	24	0.51	404	0.21	-	-	-
0.5	0.9	1	1.1	7	1.1	16	20	0.81	1022	0.52	0.97	1111	0.56
0.75	1.0	1	1.2	7	1.3	24	18	1.02	1620	0.82	1.16	1600	0.82
1	1.2	1	1.4	7	1.5	32	(17)	1.15	2050	1.04	-	-	-
-	-	-	-	-	-	-	16	1.29	2580	1.31	1.50	2580	1.32
1.5	1.5	1	1.7	7	1.8	30	(15)	1.45	3260	1.65	-	-	-
-	-	-	-	-	-	-	14	1.63	4110	2.08	1.85	4100	2.09
2.5	1.9	1	2.2	7	2.3	50	(13)	1.83	5180	2.63	-	-	-
-	-	-	-	-	-	-	12	2.05	6530	3.31	2.41	6500	3.32
4	2.4	1	2.7	7	2.9	56	(11)	2.30	8230	4.17	-	-	-
-	-	-	-	-	-	-	10	2.59	10380	5.26	2.95	10530	5.37
6	2.9	1	3.3	7	3.9	84	(9)	2.91	13100	6.63	-	-	-
-	-	-	-	-	-	-	8	3.26	16510	8.37	3.73	16625	8.48
10	3.7	1	4.2	7	5.1	80	(7)	3.67	20800	10.56	4.15	20820	10.55
-	-	-	-	-	-	-	6	4.12	26240	13.30	4.67	26250	13.39
16	4.6	1	5.3	7	6.3	126	(5)	4.62	33100	16.77	5.24	33100	16.77
-	-	-	-	-	-	-	4	5.19	41740	21.15	5.90	41650	21.24
25	-	-	6.6	7	7.8	196	3	5.83	52600	26.67	6.61	52630	26.67
35	-	-	7.9	7	9.2	276	2	6.54	66360	33.62	7.42	66150	33.74
-	-	-	-	-	-	-	1	7.35	83690	42.41	8.33	83706	42.69
50	-	-	9.1	19	11	396	1/0	8.25	105600	53.51	9.35	104640	53.36
70	-	-	11	19	13.1	360	2/0	9.27	133100	67.44	10.52	132300	67.47

Tightening torque for terminal block screws

DIN EN 60947-1

Table 4 of the standard specifies the tightening torque to demonstrate the mechanical strength of screw connections / screw terminal blocks.

These torques are sufficient for securely connecting conductors with Phoenix Contact terminal blocks.

The adjacent table lists recommended tightening torques that differ from those in this standard and will ensure gas-tight connections that remain stable in the long term.

Phoenix Contact torque screwdrivers can be set to the corresponding torques.

Extract from DIN EN 60947-1/ EN 60947-1, Table 4

The torque in accordance with IEC/EN and the recommended tightening torque for Phoenix Contact terminal blocks are specified.

Head screw with slot	
Thread	Torque
	[Nm]
M1.6	0.1*
M2.0	0.2*
M2.5 (M2.6)	0.4*
M 3	0.5*
M 4	1.2*
M4.5	1.8*
M 5	2.0*
M 6	2.5*
M 8	3.5*
M 10	4.0* / 10**
M 12	14**
M 14	19**
M 16	25**
M 20	36**
M 24	50**

* Valid for nuts and screws tightened with screwdrivers.

** Valid for nuts and screws that can be tightened with tools other than screwdrivers.

Note:

Subject to changes that serve the purpose of technical progress.

Current carrying capacity

The standard IEC 60947-7-1 / EN 60947-7-1 / DIN VDE 0611-1 specifies the test currents for the individual conductor cross sections listed in the adjacent table. The corresponding currents are listed with the connection data for the individual terminal blocks. The type testing of terminal blocks is based on this data.

The current carrying capacity of connectors in accordance with DIN EN 61984 is dependent on the number of positions and is to be found in the product-specific documentation.

Test currents in accordance with IEC 60947-7-1/EN 60947-7-1, Table 5

Rated cross section	[mm ²]	0.2	0.5	0.75	1.0	1.5	2.5	4	6	10	16
Test current	[A]	4	6	9	13.5	17.5	24	32	41	57	76

Rated cross section	[mm ²]	25	35	50	70	95	120	150	185	240	300
Test current	[A]	101	125	150	192	232	269	309	353	415	520

Touch protection

IEC 60529 / DIN EN 50274

Electrical installations and systems must also afford service technicians a high level of safety. This applies for all measurements and testing as well as for servicing.

BGV A3 prescribes the voltage-free state of the affected low-voltage system or system parts up to 1000 V AC and 1500 V DC when working in the vicinity of live parts. To prevent electric shock, live parts must be secured against direct contact through the use of covers or barriers.

In electrical systems that are only accessible to electrically skilled persons or electrically instructed persons, contact inserts for heavy-duty connectors from Phoenix Contact provide touch protection based on EN 50274. During testing based on EN 50274, the test probes are led from the operating direction to the test object. Electrical contact between the test probes and live parts is not permitted with a test force of 20 N for proof of touch-proof safety and 20 N for back of hand safety.

More detailed information is provided in the product documentation.

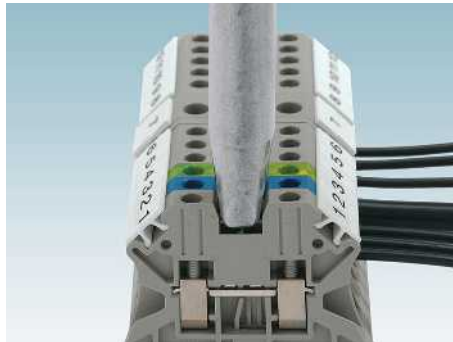

Touch-proof safety
Test finger with 12.5 mm diameter

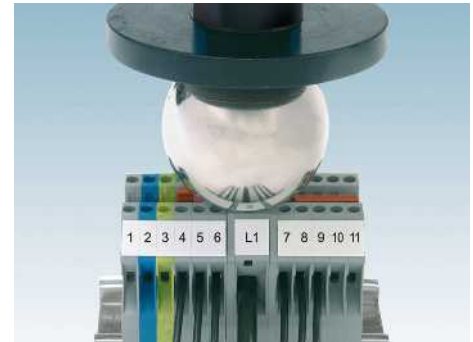

Back of hand safety
Test ball with 50 mm diameter

Color designations

Color	Code
White	WH
Red	RD
Blue	BU
Green	GN
Yellow	YE
Gray	GY
Brown	BN
Orange	OG
Black	BK
Turquoise	TQ
Ivory	IV
Beige	BE
Olive	OL
Beige	BE

EMC: Class A product:



In accordance with statutory regulations, our products are indicated with this footnote if they are intended for use in industrial environments. This means that the permitted limit values for residential applications may be exceeded in the event of conducted and emitted disturbance variables. In such cases, the operator may have to take additional safety measures in order to ensure electromagnetic compatibility in residential applications.

Degrees of protection in accordance with DIN EN 60529





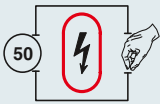

Definition:

The IP (Ingress Protection) degree of protection in accordance with DIN EN 60529 is defined by two digits (e.g. IP54), the meaning of which is explained in the following tables.

Degree of protection against access to dangerous parts and against rigid foreign objects

First digit	Short description	Example	Definition
0	Not protected		
1	Protected against rigid foreign objects		Protected against touching dangerous parts with the back of the hand. Protection against ingress of rigid foreign objects of $\varnothing > 50$ mm.
2	Protected against rigid foreign objects of \varnothing 12.5 mm or more		Protected against touching dangerous parts with a finger. Protection against ingress of rigid foreign objects of $\varnothing > 12.5$ mm.
3	Protected against rigid foreign objects of \varnothing 2.5 mm or more		Protected against touching dangerous parts with a tool. Protection against ingress of rigid foreign objects of $\varnothing > 2.5$ mm.
4	Protected against rigid foreign objects of \varnothing 1 mm or more		Protected against touching dangerous parts with a wire. Protection against ingress of rigid foreign objects of $\varnothing > 1$ mm.
5	Protected against dust		Protected against touching dangerous parts with a wire. The ingress of dust is not completely prevented, but dust may not enter in amounts sufficient to impair the satisfactory operation of the device or its safety.
6	Dust-proof		Protected against touching dangerous parts with a wire. No ingress of dust.

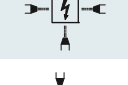
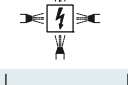
Degree of protection against water

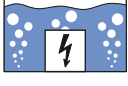
Second digit	Short description	Example	Definition
0	Not protected		
1	Protected against dripping water		Vertically falling drops shall have no effect.
2	Protected against dripping water if the housing is inclined at an angle of up to 15°		Vertically falling drops shall have no effect if the housing is inclined at an angle of up to 15° either side of the perpendicular.
3	Protected against spray water		Water that is sprayed at an angle of up to 60° either side of the perpendicular shall have no harmful effect.
4	Protected against splash water		Water that splashes against the housing from any direction shall have no harmful effect.
5	Protected against jet water		Water that is directed as a jet against the housing from any direction has no harmful effect.
6	Protected against powerful jet water		Water that is directed as a strong jet against the housing from any direction shall have no harmful effect.
7	Protected against the effect of temporary submersion in water		Water may not penetrate in a harmful quantity when the housing is temporarily submerged in water under standardized pressure and time conditions.
8	Protected against the effect of continuous submersion in water		Water may not penetrate in a harmful quantity when the housing is submerged in water continuously under conditions to be agreed between the manufacturer and user.
9K	Protected against water during high-pressure and jet-stream cleaning		Water that is directed against the housing under extremely high pressure from any direction shall have no harmful effect. (Example: IP69K in accordance with DIN 40050 Part 9)

For safety reasons, electrical equipment must be protected against external influences. This is the task of the housing, which protects electrical equipment against contact, ingress of solid objects, dust, and moisture.

The following table contains possible combinations of degrees of protection in accordance with DIN EN 60529 which can be practically applied to housing.

		Protection against water										
		No protection	Protection against vertically falling dripping water	Protection against dripping water if the housing is inclined at an angle of up to 15°	Protection against spray water from all directions, even when inclined at an angle of up to 60°	Protection against splash water from all directions	Protection against jet water from all directions	Protection against powerful jet water from all directions	Protection against temporary submersion	Protection against the effects of continuous submersion in water	Protected against water during high-pressure and jet-stream cleaning (DIN 40050-9)	
Touch protection	Foreign object protection	IP0x	IPx0	IPx1	IPx2	IPx3	IPx4	IPx5	IPx6	IPx7	IPx8	IPx9K
No touch protection	No protection against solid foreign objects	IP0x	IP00									
Back of hand safety	Protection against solid foreign objects >50 mm Ø	IP1x	IP10	IP11	IP12							
Touch-proof	Protection against solid foreign objects >12.5 mm Ø	IP2x	IP20	IP21	IP22	IP23						
Protection against touching with tools, wires, etc. >2.5 mm Ø	Protection against solid foreign objects >2.5 mm Ø	IP3x	IP30	IP31	IP32	IP33						
Protection against touching with tools, wires, etc. >1 mm Ø	Protection against solid foreign objects >1.5 mm Ø	IP4x	IP40	IP41	IP42	IP43	IP44					
Protection against touching with tools, wires, etc. >1 mm Ø	Protection against harmful dust accumulations inside the device	IP5x	IP50				IP54	IP55				
Protection against touching with tools, wires, etc. >1 mm Ø	No ingress of dust	IP6x	IP60					IP65	IP66	IP67	IP68	IP69K

Connector safety requirement and test

DIN EN 61984

Dimensioning of creepage distances for connectors with a degree of protection of IP54 or higher.

For a connector with a degree of protection of at least IP54 in accordance with IEC 60529, isolating parts (air clearances and creepage distances) within the encapsulation may be rated for a low pollution degree.

This also applies to plug-in connectors in which the encapsulation is assured by the connector housing and which are only separated for testing and maintenance purposes.

Quality features of insulation material

Our insulating housings are made from various thermoplastic materials. Depending on the application, the best-suited material is selected based on its electrical and mechanical properties.

All plastics used by Phoenix Contact are RoHS-compliant.

All plastics used at Phoenix Contact have been listed with UL (Underwriters Laboratories Inc.) in the USA.

Behavior of plastics under the influence of temperature (operating temperatures)

All plastics undergo thermal aging when they are subjected to heat over long periods. This process causes changes in the mechanical and electrical properties of the material. External influences, e.g., radiation, additional mechanical, chemical or electrical stresses, amplify this effect. All characteristics included in the table have been determined based on samples, which provides a good means of drawing comparisons between different plastics. However, applying these characteristics to an evaluation of molded plastic parts is only possible to a limited extent, and can only give the designer a rough guide when it comes to selecting a plastic material. This catalog uses the electrical RTI in accordance with UL 746B as an assessment criterion for temperature resistance.

Insulation materials

Polyamide: PA and PA-GF

Polyamide has excellent electrical, mechanical, and chemical properties even at high operating temperatures. Brief peak temperatures of up to approximately 200°C are permitted as a result of heat aging stabilization. The absorption of water makes the plastic stranded and resistant to breakage, even at low temperatures.

Fiber-reinforced polyamides feature greater rigidity and hardness and can be used at temperatures higher than those of non-reinforced materials.

Polyamide for high-temperature applications: PA HT and PA-GF HT

Special types of polyamide resistant to high temperatures are used in non-reinforced and fiberglass-reinforced versions for reflow applications. These high-temperature polyamides combine the excellent electrical properties of polyamides and the requirements of the reflow soldering process for temperature resistance.

Liquid crystal polymers: LCP GF

LCPs combine high temperature stability with excellent dimensional stability and creepage resistance for products used in reflow processes. LCPs have exceptional mechanical properties across a wide temperature range as well as a very low thermal expansion.

Polyester: PBT and PBT-GF

We use thermoplastic polyester in non-reinforced and fiberglass-reinforced versions for special applications that require increased dimensional and form stability.

In addition to the high operating temperature, the material is characterized by excellent mechanical stability, hardness, and excellent notched impact strength. PBT does not absorb moisture from its surroundings. PBT is therefore particularly suitable for strips, for example, which are soldered onto PCBs.

Polycarbonate: PC

Polycarbonate combines many advantages such as rigidity, impact strength, transparency, dimensional stability, good insulation properties, and resistance to heat.

The amorphous material only absorbs moisture to a very limited degree, and is used for items such as large, rigid electronic component housings.

In its transparent form, polycarbonate is particularly suitable for use as a material for cover profiles or marking materials.

Acrylonitrile butadiene styrene: ABS

We use ABS for products that must have good impact and notched impact properties in addition to high mechanical stability and rigidity. The products are also characterized by their special surface quality and hardness.

ABS is suitable for coating metal surfaces, e.g., nickel.

Polyvinyl chloride: PVC

While most thermoplastic materials are processed with injection molding using ready-to-use molding and extrusion material, PVC is processed as a granulate in the extruder. This is why it is used in our profile products. PVC is also self-extinguishing without flame protection and has high mechanical strength but is also notch-sensitive.

Polyoxymethylene: POM

Polyoxymethylene is a technical material that combines high rigidity with mechanical stability, excellent elastic properties, high toughness, dimensional accuracy, and exceptional sliding friction behavior.

Polyethylene: PE

Polyethylene is characterized by excellent chemical resistance and electrical insulation properties. PE is thermoplastic and can therefore be processed by almost all methods. Furthermore, PE has excellent toughness even at low temperatures and a good elongation at break.

Polypropylene: PP

PP has higher rigidity, hardness, and stability and is more heat-resistant than PE. However, PP is not as tough at low temperatures.

Thermoplastic polyurethane: TPU and TPU-GF

TPU is characterized by excellent electrical properties, a good surface feel, a high degree of flexibility over a wide temperature range, and high resistance to wear. Thermoplastic polyurethanes are also elastic and low-temperature impact resistant.

In contrast to non-reinforced materials, fiberglass-reinforced TPU is characterized by high rigidity and hardness.

Cross-linked ethylene-propylene-diene polymer/polypropylene: PP/EPDM

PP/EPDM is a polymer blend of PP and cross-linked EPDM. PP/EPDM is a rubber-like material that can be processed using thermoplastic methods. PP/EPDM combines high temperature resistance, a low compression set, good resistance to abrasion, and good resistance to chemicals.

Acrylonitrile butadiene styrene rubber: NBR

NBR is a rubber with excellent resistance to aging. It also features excellent resistance to abrasion and has a low plastic flow. Its elasticity is lower than other rubbers.

Fluorinated rubber: FPM

FPM rubbers are characterized by very high temperature resistance, but behave less favorably at low temperatures than other rubbers.

Chlorine-butadiene rubber: CR

CR rubber stands out against other rubbers with its excellent resistance to weather and ozone.

Properties	Standard	Unit	PA	PA GF	PA HT	PA GF HT	PBT	PBT GF	LCP GF	PC	ABS	PVC	POM	PP	PE
RTI elec ¹⁾	UL 746B	°C	≥105	≥105	≥105	≥105	≥105	≥105	≥130	≥105	≥ 80	≥ 50	≥ 105	65	50
Minimum temperature for use (without mechanical load)		°C	-40	-40	-40	-40	-40	-40	-40	-40	-40	-15	-40	-40	-40
Electric strength	IEC 60243-1 / DIN VDE 0303-21	kV/mm	25	18	20	33	28	40	50	30	41	40	35	30	50
Resistance to creepage CTI...	IEC 60112 / DIN VDE 0303-1	-	600	400	³ 250	225	600	225	175	175	600	600	600		
Resistance to creepage CTI...M	IEC 60112 / DIN VDE 0303-1	-	550	250			600	225		175	600	600	600		
Flammability rating	UL 94	HB – V0	V2, V0	HB, V0	V0	V0	V0	V0	V0	V2, V0		V0	HB	HB	HB
Termite resistance and resistance to tropical conditions			Good	Good			Good			Good					

¹⁾ Where "2" is shown, higher temperatures are possible, but not recommended due to increased aging of plastics and insufficient current carrying capacity.

Properties	Standard	Unit	TPU	TPU GF	EPDM/PP	Properties	Standard	Unit	NBR	FPM	CR
RTI elec	UL 746B	°C	50	50	100	Operating temperature		°C	≤100	≤200	≤100
Minimum temperature for use (without mechanical load)		°C	-40	-40	-40	Minimum temperature for use (without mechanical load)		°C	-40	-25	-40
Electric strength	IEC 60243-1 / DIN VDE 0303-21	kV/mm	30	37		Electric strength	IEC 60243-1 / DIN VDE 0303-21	kV/cm	Not relevant as these are sealing materials		
Resistance to creepage CTI...	IEC 60112 / DIN VDE 0303-1	-	600	600	600	Resistance to creepage CTI...	IEC 60112 / DIN VDE 0303-1	-			
Resistance to creepage CTI...M	IEC 60112 / DIN VDE 0303-1	-	600			Resistance to creepage CTI...M	IEC 60112 / DIN VDE 0303-1	-			
Flammability rating	UL 94	HB – V0	V2	HB	HB	Flammability rating	UL 94	HB – V0			
Chemical resistance	See table for resistance to chemicals										

Resistance to chemicals

- Not resistant
- 0 Moderately resistant
- + Good resistance

Chemicals	Plastics																	
	Concentration in %	Temperature in °C	PA 66 / PA 6	PA 66 GF	PA 46 GF	PC GF	POM	NBR	PP	EPDM	PBT	PUR	PUR irradiated*	PVC-P (soft)	PE-LD	TPU	FPM (Viton)	CR (neoprene)
Acetaldehyde			0	0	0	-	0	-	+	0	0	+	+	+	0	0	-	0
Acetone		20	+	+	+	0	+	-	+	+	0	0	+	+	+	-	-	0
Acetate			+	+	+	0	0	-	+	0	0	+	+	-	-	-	-	-
Acetophenone			+	+	+	0	0	-	+	0	0	+	+	-	-	-	-	-
Aldehyde			0	0	0	-	0	-	-	0	+	+	+	+	0	-	0	0
Formic acid			-	-	0	0	+	-	+	+	+	0	0	-	+	0	0	+
Amines			+	+	+	-	0	-	+	0	+	+	+	+	0	-	-	-
Alcohols			0	0	0	0	+	0	+	+	+	+	+	+	+	+	0	+
Ammonia	10	20	+				+	0	+	+	+	+	+	0	+	0	-	+
Benzaldehyde			0	0	0	-	0	-	-	0		+	+	+	0	0	-	0
Gasoline		20	+	+	+	0	+	0	0	-	+	+	+	-	-	-	+	-
Benzol		50	+	+	+	+	0	-	0	-	0	0	0	-	0	-	0	-
Benzophenone		20	+	+	+	0	0	-	+	0	0	+	+	-	-	-	+	-
Boric acid	100	20	0				0	+		+	+	0	0	0	+	+	+	+
Brake fluid		100	+				+	-		+	+	-	-	0	+	-	-	-
Butyric acid			-	-	0	0	+	0	+	+	+	0	0	+	+	-	0	0
Cyclohexanone			+	+	+	0	0	-	+	0	0	+	+	-	-	-	-	-
Diesel oil			+				+	+	-	+	+	+	+	-	-	-	+	-
Diethylamine			+	+	+	-	0	-	-	0	+	+	+	+	-	-	-	-
Dimethylamine			+	+	+	-	0	-	-	0	+	+	+	+	0		-	-
Glacial acetic acid		50	-	-	-	-	-	-	0	+	-	-	-	-	+	-	-	-
Acetic acid	20		-	-	0	0	+	-	+	+	0	0	0	0	+	-	-	0
Esters			+	+	+	0	-	-	-	0	+			-	+	-	-	-
Ethanol			0	0	0	0	+	0	+	+	+	+	+	-	+	+	+	+
Ether			+	+	+	-	0	-	0	0	+	+	+	+	0	+	-	-
Greases			+	+	+	+	+	+	0	0				0	+	-	+	0
Formaldehyde			0	0	0	-	0	-	-	0		+	+	+	0	0	+	0
Gear oil		100	+				+	+		-	+	+	+	+	+	-	+	-
Halogens (fluorine, chlorine, bromine, iodine)			-	-	-	+	-	-	-	-	-	-	-	-	-	-	+	-
Hydraulic oil		20	+				0	+		-	+	+	+	-	+	-	+	-
Potassium hydroxide solution			+	+	+	-	+	0	+		-	+	+	+	+	0	+	-
Kerosene		20	+				+				+	+	+	-	0	-	+	-
Ketones			+	+	+	0	0	-	+	0	0	+	+	-	-	-	-	-
Hydrocarbons, aliphatic			+	+	+	+	+	+	0	0	+	+	+	-	+	+	+	-
Hydrocarbons, aromatic			+	+	+	-	0	-	0	0	0	+	+	-	-	-	+	-
Hydrocarbons, chlorinated			0	0	0	-	+	-	-	-	0	-	-	-	-	-	+	-
Hydrocarbons, unsaturated chlorinated			0	0	0	-	+	-	-	-	0	0	0	-	-	-	+	-
Fuels			+	+	+	0	+	0	0	-	+	+	+	-	-	-	+	-
Alkalis, weak			+	+	+	-	+	0	+	+	+	+	+	+	+	0	+	0
Alkalis, strong			0	-	-	-	+	-	+		+	-	-	+	0	0	-	-
Inorganic salt solutions			+	+	+	-	+	+	+	+	+	+	+	+	+	+	+	+
Machine oil			+				+				+	+	+	0	+	-	+	-
Metal chloride			+	+	+	-	+	+	+	+	+	+	+	+	+	+	+	+
Metal sulfate			+	+	+	-	+	+	+	+	+	+	+	+	+	+	+	+
Metal nitrate			+	+	+	-	+	+	+	+	+	+	+	+	+	+	+	+
Methanol			0	0	0	0	+	0	+	+	+	+	+	-	+	+	-	+
Methylamine			+	+	+	-	0	-	-	0	+	+	+	+	+	0	0	-
Lactic acid	10	20	+				+	+	+	+	+	+	+	-	+	+	+	+
Mineral oil			+	+	+		+	+	+	-	+	+	+	-	+	-	+	-
Motor oil		120	+	+	+	0	+	+	+	-	+	+	+	-	+	-	+	-
Sodium hydroxide solution	50	50	0	0	+	-	+	+	+	+	-	+	+	+	+	0	0	0
Nitrobenzene			0				0	-		0	+	-	-	-	0	+	0	-
Ozone			0	0	0	-	0	-	+	+	0	0	+	+	+	0	+	-
Propyl alcohol			0	0	0	0	+	0	+	+	+	+	+	-	+	+	+	+
Nitric acid	30	20	-	0	-	0	-	-	+	0	0	0	0	-	+	-	+	-
Hydrochloric acid		20	-				-	0	+	0	0	-	-	-	+	0	+	0
Sulfuric acid	50	50	-	0	-	0	-	-	+	+	-	0	0	+	+	0	+	-
Salt water		20	+	+	+	+	+	+	+	+	+	+	+	+	+	+	+	+
Turpentine			0	0	0	+	-	+	-	-	+	0	0	-	-	-	+	-
UV resistance			+	+	+	0	0	-	-	-	+	+	+	0	0	+	+	+
Detergent alkalis	2	100	0				+	+		+	+	+	+	-	+	+	+	0
Water (dist.)		20												+				
Water, cold			+	+	+	+	+	+	+	+	+	+	+	+	+	+	+	+
Water, hot			-	-	-	-	+	+	+	+	-	+	+	+	+	0	+	0
Citric acid	10		+				+	+	+	+	+			+	+	+	+	+

* The irradiated PUR version is generally more resistant than the non-irradiated version. This cannot be quantified and must be checked in individual cases.

The information in the table has been gathered from the recommendations of our plastic suppliers.

Since individual operating conditions can also affect the usability of each product, this information should be used as a guide only.

For applications where no prior experience exists, we recommend that the user carries out preliminary tests.

Insulation coordination for electrical equipment in low-voltage systems

Rating of air clearances and creepage distances in accordance with DIN EN 60664-1 / VDE 0110-1.

This part of the standard is based on IEC 60664. It contains the specifications for insulation coordination for equipment in low-voltage systems. This part is applicable for equipment for use up to an altitude of up to 2000 m above sea level. This basic safety standard is primarily aimed at technical committees. If suitable product directives are not available for a piece of equipment, the standard can be applied at the responsibility of the user. International and European product standards are cited in this catalog. These standards contain specifications for insulation coordination in accordance with DIN EN 60664 / VDE 0110-1.

Insulation coordination

Insulation coordination includes the selection of electrical insulation properties for equipment depending on the intended application and ambient conditions. Separate requirements must be applied for air clearances and creepage distances and for fixed insulation. The surge voltages to be expected, the characteristics of surge protective devices, and the pollution levels at the intended site must be considered when dimensioning clearances. Clearances are to be dimensioned in accordance with the external or internal surge voltages to be expected. Different overvoltages, grouped into categories, with a numerical value that determines an impulse withstand voltage, determine the required clearance directly. These overvoltage categories (I to IV) are used for equipment that is directly supplied by low-voltage grids. They are primarily based on a statistical study. Definitions of the individual categories are listed below as an extract of the DIN EN 60664 / VDE 0110-1 standards.

The clearances can be calculated in accordance with Table 2, Minimum clearances, depending on the homogeneity level of the field between the electrodes (case A – non-homogeneous field, case B – homogeneous field).

Clearances in accordance with case A are capable of withstanding the assigned impulse voltages under all conditions. Equipment rated in accordance with case a can therefore be used without further testing. Clearance values in accordance with case B are based on ideal conditions. Clearance values falling between case A and case B must be verified via an impulse voltage test.

The voltages present, the properties of the insulation materials, the pollution levels to be expected, and safety measures against pollution are considered when dimensioning creepage distances.

The effect of pollution is considered when determining the air clearances and creepage distances in accordance with three degrees of severity (pollution degree 1 to 3).

The creepage distances are based on the rated voltage, which is derived from the working voltage or nominal mains voltage. The minimum creepage distances are assigned to the rated voltages in accordance with the pollution degree in Table 4.

If the respective product descriptions do not contain any additional specifications, the products listed in this catalog are rated for overvoltage category III and pollution degree 3 in accordance with this provision (DIN EN 60664-1 / VDE 0110-1).

Overvoltage categories I to IV

– Equipment in **overvoltage category IV** can be used at the terminal point of the installation.

Note: Examples of this kind of equipment include electricity meters and primary overcurrent protection devices.

– Equipment in **overvoltage category III** can be used in fixed installations and in cases where there are special requirements on the reliability and availability of the equipment.

Note: Examples of this kind of equipment include switches in fixed installations and equipment for industrial use that is permanently connected to the fixed installation.

– Equipment in **overvoltage category II** is energy-consuming equipment fed by the fixed installation.

Note: Examples of this kind of equipment include household appliances, portable tools, other domestic appliances, and similar devices.

– Equipment in **overvoltage category I** can be connected to circuits in which measures have been taken to limit the transient overvoltages to a suitably low value.

Pollution degrees 1 to 4

The following four pollution degrees have been defined for the micro-environment in order to determine air clearances and creepage distances:

– Pollution degree 1

No pollution or only dry, non-conductive pollution occurs. The pollution does not have an effect.

– Pollution degree 2

Only non-conductive pollution occurs. However, temporary conductivity due to condensation is to be expected.

– Pollution degree 3

Conductive pollution occurs or dry, non-conductive pollution which becomes conductive, since condensation is to be expected.

– Pollution degree 4

Permanent conductivity occurs, caused by conductive dust, rain or moisture.

Insulation material

DIN EN 60664 / VDE 0110-1 classifies insulation materials into four groups depending on their CTI values obtained using solution A in accordance with IEC 60112.

Insulation material group I: $600 \leq CTI$

Insulation material group II:

$400 \leq CTI \leq 600$

Insulation material group III a:

$175 \leq CTI < 400$

Insulation material group III b:

$100 \leq CTI < 175$.

The comparative tracking index of the creepage distance formation must have been determined based on suitable samples using test solution A in accordance with DIN IEC 60112.

The proof tracking index of the creepage distance formation (PTI) is used as proof of the creepage current properties of insulation materials.

Dimensioning of clearances

Schematic for determining clearances

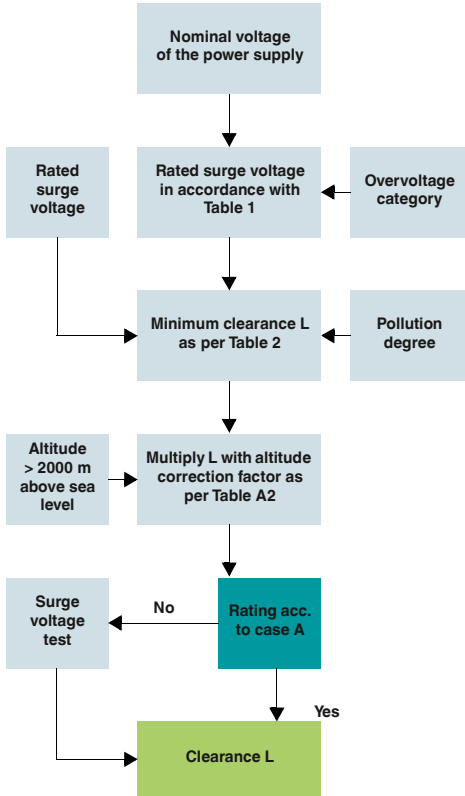

Rated surge voltages for equipment that is directly supplied by the low-voltage network (extract from Table 1)

Nominal voltage of the power supply system ¹⁾ (mains) as per IEC 60038 ³⁾		Conductor-neutral conductor voltage derived from the total nominal AC voltage or nominal DC voltage	Rated surge voltage ²⁾ [V]			
Three-phase [V]	Single-phase [V]		Overvoltage category ⁴⁾			
			I	II	III	IV
		50	330	500	800	1500
		100	500	800	1500	2500
		150	800	1500	2500	4000
230/400	277/480	300	1500	2500	4000	6000
		600	2500	4000	6000	8000
		1000	4000	6000	8000	12000

¹⁾ Refer to Annex B for application in existing deviating low-voltage networks and their nominal voltages.

²⁾ Equipment with this rated surge voltage may be used in systems in accordance with IEC 60364-4-443.

³⁾ The slash, i.e., /, indicates a three-phase four-conductor system. The lower value is the conductor-to-neutral-conductor voltage, whereas the higher value is the conductor-to-conductor voltage. When only one value is specified, it refers to a three-phase three-conductor system, and indicates the conductor-to-conductor voltage.

⁴⁾ Refer to 2.2.2.1.1 for an explanation of overvoltage categories.

Minimum clearances for transient overvoltages (extract from Table 2)

Required impulse withstand voltage ¹⁾ ⁵⁾ [kV]	Condition A Non-homogeneous field (refer to 3.15)			Condition B Homogeneous field (refer to 3.14)		
	Pollution degree ⁶⁾			Pollution degree ⁶⁾		
	1 [mm]	2 [mm]	3 [mm]	1 [mm]	2 [mm]	3 [mm]
0.33 ²⁾	0.01	0.2 ³⁾ ⁴⁾	0.8 ⁴⁾	0.01	0.2 ³⁾ ⁴⁾	0.8 ⁴⁾
0.40	0.02			0.02		
0.5 ²⁾	0.04			0.04		
0.60	0.06			0.06		
0.80 ²⁾	0.10			0.10		
1.0	0.15			0.15		
1.2	0.25	0.25		0.2		
1.5 ²⁾	0.5	0.5		0.3	0.3	
2.0	1.0	1.0	1.0	0.45	0.45	
2.5 ²⁾	1.5	1.5	1.5	0.6	0.6	
3.0	2.0	2.0	2.0	0.8	0.8	
4.0 ²⁾	3	3	3	1.2	1.2	1.2
5.0	4	4	4	1.5	1.5	1.5
6.0 ²⁾	5.5	5.5	5.5	2	2	2
8.0 ²⁾	8	8	8	3	3	3
10	11	11	11	3.5	3.5	3.5
12 ²⁾	14	14	14	4.5	4.5	4.5
15	18	18	18	5.5	5.5	5.5
20	25	25	25	8	8	8
25	33	33	33	10	10	10
30	40	40	40	12.5	12.5	12.5
40	60	60	60	17	17	17
50	75	75	75	22	22	22
60	90	90	90	27	27	27
80	130	130	130	35	35	35
100	170	170	170	45	45	45

¹⁾ This voltage is:

- For function insulation: the highest surge voltage expected for the clearance
- For basic insulation, if influenced directly or considerably by transient overvoltages from the low-voltage network: the rated surge voltage of the equipment
- For a different basic insulation: the highest surge voltage possible in the circuit.

²⁾ Preferred values

³⁾ For PCBs, the values of pollution degree 1 are applicable, except that no deviation below the value of 0.04 mm is permitted, as specified in Table 4.

⁴⁾ Minimum clearances for pollution degrees 2 and 3 are based on the corresponding creepage distances. This resistance is reduced due to the effects of humidity.

⁵⁾ Values can be interpolated for parts or circuits within equipment that are subjected to surge voltages.

⁶⁾ The distances for pollution degree 4 are equal to those for pollution degree 3, except that the minimum clearance is 1.6 mm.

Altitude correction factors (extract from Table A.2)

Altitude [m]	Normal air pressure [kPa]	Multiplication factor for distances
2000	80.0	1.00
3000	70.0	1.14
4000	62.0	1.29
5000	54.0	1.48
6000	47.0	1.70
7000	41.0	1.95
8000	35.5	2.25
9000	30.5	2.62
10,000	26.5	3.02
15,000	12.0	6.67
20,000	5.5	14.50

Dimensioning of creepage distances

Schematic for determining creepage distances

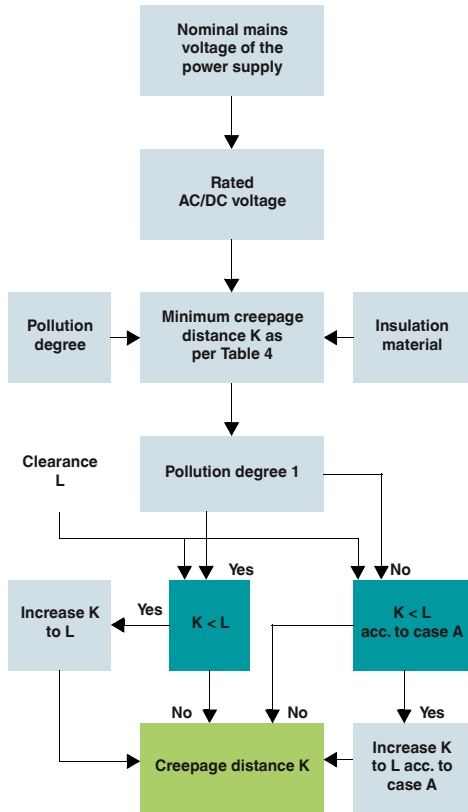

Nominal voltage of the power supply system (mains) *)	Voltages for Table 4	
	For conductor-to-conductor insulation 1)	For conductor-to-ground insulation 1)
	All systems	Three-conductor systems center point grounded
[V]	[V]	[V]
12.5	12.5	-
24	25	-
25	-	-
30	32	-
42	50	-
48	-	-
50 **)	-	-
60	63	-
30-60	63	32
100 **)	100	-
110	125	-
120	-	-
150 **)	160	-
220	250	-
110-220	250	125
220-240	-	-
300 **)	320	-
220-440	500	250
600 **)	630	-
480-960	1000	500
1000 **)	1000	-

1) Conductor-to-ground insulation levels for non-grounded systems or those grounded through impedance correspond to conductor-to-conductor insulation levels as the operating voltage of every conductor to ground can, in practice, reach the conductor-to-conductor voltage. This is based on the fact that the actual voltage to ground is determined by the insulation resistance and capacitive reactance of each conductor to ground. Therefore, a low (but permissible) insulation resistance of a conductor can practically ground this and raise the two others to conductor-to-conductor voltage to ground.

*) Refer to 2.2.1 for correlation with the rated voltage.
**) These values correspond to the values in Table 1.

Nominal voltage of the power supply system (mains) *)	Voltages for Table 4		
	For conductor-to-conductor insulation	Insulation for conductor to ground	
		All systems	Three-phase four-conductor systems with grounded neutral conductor 2)
[V]	[V]	[V]	[V]
60	63	32	63
110/120/127	125	80	125
150 **)	160	-	160
208	200	125	200
220/230/240	250	160	250
300 **)	320	-	320
380/400/415	400	250	400
440	500	250	400
480/500	500	320	500
575	630	400	630
600 **)	630	-	630
660/690	630	400	630
720/830	800	500	800
960	1000	630	1000
1000 **)	1000	-	1000

1) Conductor-to-ground insulation levels for non-grounded systems or those grounded through impedance correspond to conductor-to-conductor insulation levels as the operating voltage of every conductor to ground can, in practice, reach the conductor-to-conductor voltage. This is based on the fact that the actual voltage to ground is determined by the insulation resistance and capacitive reactance of each conductor to ground. Therefore, a low (but permissible) insulation resistance of a conductor can practically ground this and raise the two others to conductor-to-conductor voltage to ground.

2) For equipment designed for use in three-phase four-conductor and three-phase three-conductor systems, grounded as well as non-grounded, only the values for three-conductor systems may be used.

*) Refer to 2.2.1 for correlation with the rated voltage.
**) These values correspond to the values in Table 1.















































Creepage distances to prevent failures occurring due to creepage (extract from Table 4)

Voltage 1) r.m.s. value	Minimum creepage distances											
	Printed circuits			Pollution degree								
	Pollution degree			1			2			3		
	All insulation material groups	All insulation material groups except III b	All insulation material groups	Insulation material group			Insulation material group					
[V]	[mm]	[mm]	[mm]	I [mm]	II [mm]	III [mm]	I [mm]	II [mm]	III 2) [mm]			
10	0.025	0.04	0.08	0.4	0.4	0.4	1.00	1.00	1.00			
12.5	0.025	0.04	0.09	0.42	0.42	0.42	1.05	1.05	1.05			
16	0.025	0.04	0.10	0.45	0.45	0.45	1.10	1.10	1.10			
20	0.025	0.04	0.110	0.48	0.48	0.48	1.20	1.20	1.20			
25	0.025	0.04	0.125	0.5	0.5	0.5	1.25	1.25	1.25			
32	0.025	0.04	0.140	0.53	0.53	0.53	1.30	1.30	1.30			
40	0.025	0.04	0.16	0.56	0.8	1.1	1.4	1.6	1.8			
50	0.025	0.04	0.18	0.6	0.85	1.2	1.5	1.7	1.9			
63	0.040	0.63	0.20	0.63	0.9	1.25	1.6	1.8	2.0			
80	0.063	0.10	0.22	0.67	0.95	1.3	1.7	1.9	2.1			
100	0.10	0.16	0.25	0.71	1.0	1.4	1.8	2.0	2.2			
125	0.16	0.25	0.28	0.75	1.05	1.5	1.9	2.1	2.4			
160	0.25	0.4	0.32	0.8	1.1	1.6	2.0	2.2	2.5			
200	0.40	0.63	0.42	1.0	1.4	2.0	2.5	2.8	3.2			
250	0.56	1.0	0.56	1.25	1.8	2.5	3.2	3.6	4.0			
320	0.75	1.6	0.75	1.6	2.2	3.2	4.0	4.5	5.0			
400	1.0	2.0	1.00	2.0	2.8	4.0	5.0	5.6	6.3			
500	1.3	2.5	1.30	2.5	3.6	5.0	6.3	7.1	8.0			
630	1.8	3.2	1.80	3.2	4.5	6.3	8.0	9	10.0			
800	2.4	4.0	2.40	4.0	5.6	8.0	10.0	11	12.5			
1000	3.2	5.0	3.20	5.0	7.1	10	12.5	14	16.0			
1250			4.20	6.3	9	12.5	16	18	20			
1600			5.60	8	11	16	20	22	25			
2000			7.50	10	14	20	25	28	32			
2500			10	12.5	18	25	32	36	40			
3200			12.5	16	22	32	40	45	50			
4000			16	20	28	40	50	56	63			
5000			20	25	36	50	63	71	80			
6300			25	32	45	63	80	90	100			
8000			32	40	56	80	100	110	125			
10,000			40	50	71	100	125	140	160			

1) This voltage is:
a) For function insulation: the working voltage.
b) For basic and additional insulation of a circuit supplied directly by the low-voltage network: either the voltage selected from Table 3 a or 3 b on the basis of the rated voltage of the equipment or the rated insulation voltage.
c) For basic and additional insulation of systems, equipment, and internal circuits which are not supplied directly from the mains: the highest r.m.s. value of the voltage that, within the bounds of the rated data, can occur in the system, the equipment or the internal circuit, when supplied with rated voltage and in the case of the most unfavorable combination of operating conditions.

2) With pollution degree 3, insulation material group III b is not recommended for use if voltages are greater than 630 V.

Certification authorities and marks

Certification authorities and approvals	Country code	Explosion protection	Country code	Marine classification societies	Country code
 IECEE CB Scheme (in combination with certifying body)	International	 International Electrotechnical Commission	International	 DNV GL - MARITIME	DE
 CENELEC Certification Agreement (CCA inspection report) (in combination with certifying body)	EU	 ATEX Directive	EU	 Bureau Veritas	FR
 Canadian Standards Association (CSA)	CA	 Canadian Standards Association (CSA)	CA	 Lloyd's Register of Shipping	GB
 Canadian Standards Association (CSA) - CSA approval for the USA -	US	 Canadian Standards Association (CSA) - CSA approval for the USA -	US	 Nippon Kaiji Kyokai	JP
 Canadian Standards Association (CSA) combined logo - CSA approval for Canada and the USA -	CA US	 Canadian Standards Association (CSA) combined logo - CSA approval for Canada and the USA -	CA US	 Polski Rejestr Statków	PL
 Underwriters Laboratories Inc. (UL)	US	 Underwriters Laboratories Inc. (UL)	US	 Russian Maritime Register of Shipping	RU
 Underwriters Laboratories Inc. (UL) - UL approval for Canada -	CA	 Underwriters Laboratories Inc. (UL) - UL approval for Canada -	CA	 Korean Register of Shipping	KR
 Underwriters Laboratories Inc. (UL) combined logo - UL approval for the USA and Canada -	US CA	 Underwriters Laboratories Inc. (UL) combined logo - UL approval for the USA and Canada -	US CA	 American Bureau of Shipping	US
 INSIEME PER LA QUALITA' LA SICUREZZA	IT	 FM Approvals	US	 Registro Italiano Navale	IT
 Eurasian Conformity	EAEU	 FM Approvals - FM approval for Canada -	CA		
 DEKRA Certification B.V.	NL	 FM Approvals - FM approval for the USA and Canada -	US CA		
 Österreichischer Verband für Elektrotechnik	AT	 Eurasian Conformity for Ex-products	EAEU		
 Eurofins Electrosuisse Product Testing AG SEV certification scheme	CH	 Korean Certification Mark for Ex-products	KR		
 Verband Deutscher Elektrotechniker e.V. (VDE) - Approval of drawings - Reports with production monitoring	DE	 National Institute of Metrology, Standardization and Industrial Quality	BR		
 Berufsgenossenschaft (BG) GS - Geprüfte Sicherheit (tested safety)	DE	 National Supervision and Inspection Center for Explosion Protection and Safety of Instrumentation	CN		
 Intertek ETL Listed - Approval for the USA -	US	 Corp. Centro de Investigación y Desarrollo Tecnológico del Sector Eléctrico	CO		
 Intertek ETL Listed - Approval for Canada -	CA				
 Intertek ETL Listed - Approval for the USA and Canada -	US CA				
 TÜV Rheinland Industrie Service GmbH	DE				
 China Compulsory Certification	CN				
 Korean Certification Mark	KR				

Index

Alphabetical

Type	Order No.	Page	Type	Order No.	Page	Type	Order No.	Page	Type	Order No.	Page	
A	A 0,5 - 6	3200218	312	A-INL-PG42-P-GY	1411229	687	CA-06P1N128006	1619749	86	CA-06S1N8A8008S	1619506	84
	A 0,75-10	3200234	312	A-INL-PG42-P-LG	1424556	687	CA-06P1N128006S	1619578	84	CA-06S1N8A800DN	1619774	84
	A 1 - 10	3200250	312	A-INL-PG48-N-S	1411266	689	CA-06P1N128007	1619723	86	CA-06S1N8A80DNS	1619603	86
	A 1,5 - 10	3200276	312	A-INL-PG48-P-BK	1424567	687	CA-06P1N128007S	1619533	84	CA-06S1N8A9006	1620143	88
	A-INB-M12-69KN-P-BK	1415223	695	A-INL-PG48-P-GY	1411230	687	CA-06P1N128008	1619658	86	CA-06S1N8A9007	1620117	88
	A-INB-M12-69KN-P-LG	1415222	695	A-INL-PG48-P-LG	1424557	687	CA-06P1N128008S	1619507	84	CA-06S1N8A9008	1620044	88
	A-INB-M12-69KN-S-S	1415224	695	A-INL-PG7-N-S	1411255	689	CA-06P1N1280DN	1619775	86	CA-06S1N8A900DN	1620170	88
	A-INE-PG13/16-N-NS-S	1415219	701	A-INL-PG7-P-BK	1424558	687	CA-06P1N1280DNS	1619604	84	CA-06S1N8AHZ00	1619849	102
	A-INE-PG16/21-N-NS-S	1415220	701	A-INL-PG7-P-GY	1411221	687	CA-06P1N129006	1620144	88	CA-06S1N8AT006	1620289	92
	A-INE-PG21/29-N-NS-S	1415221	701	A-INL-PG7-P-LG	1424548	687	CA-06P1N129007	1620118	88	CA-06S1N8AT006S	1619422	90
A-INL-M12-N-S	1411240	688	A-INL-PG9-N-S	1411256	689	CA-06P1N129008	1620045	88	CA-06S1N8AT007	1620260	92	
A-INL-M12-P-BK	1411213	686	A-INL-PG9-P-BK	1424559	687	CA-06P1N1290DN	1620171	88	CA-06S1N8AT007S	1619396	90	
A-INL-M12-P-GY	1411205	686	A-INL-PG9-P-GY	1411222	687	CA-06P1N12HZ00	1619850	102	CA-06S1N8AT008	1620210	92	
A-INL-M12-P-LG	1417659	686	A-INL-PG9-P-LG	1424549	687	CA-06P1N12T006	1620290	92	CA-06S1N8AT008S	1619368	90	
A-INL-M12-S-S	1425175	692	A-INLE-M12-N-S	1411267	690	CA-06P1N12T006S	1619423	90	CA-06S1N8AT0DN	1619341	92	
A-INL-M16-N-S	1411241	688	A-INLE-M16-N-S	1411268	690	CA-06P1N12T007	1620261	92	CA-06S1N8AT0DNS	1619448	90	
A-INL-M16-P-BK	1411214	686	A-INLE-M20-N-S	1411269	690	CA-06P1N12T007S	1619397	90	CA-07P1N122S00	1619988	100	
A-INL-M16-P-GY	1417658	686	A-INLE-M25-N-S	1411270	690	CA-06P1N12T008	1620211	92	CA-07P1N126L00	1624046	98	
A-INL-M16-P-LG	1417660	686	A-INLE-M32-N-S	1411271	690	CA-06P1N12T008S	1619371	90	CA-07P1N126Y00	1619872	96	
A-INL-M16-S-S	1425176	692	A-INLE-M40-N-S	1411272	690	CA-06P1N12T0DN	1619342	92	CA-07P1N126Z00	1619898	94	
A-INL-M16-P-BK	1411214	686	A-INLE-M50-N-S	1411273	690	CA-06P1N12T0DNS	1619449	90	CA-07P1N128006	1619745	86	
A-INL-M16-P-GY	1417659	686	A-INLE-M63-N-S	1411274	690	CA-06P1N8A2S00	1619990	100	CA-07P1N128006S	1619574	84	
A-INL-M16-P-LG	1417660	686	A-INLE-PG11-N-S	1411277	691	CA-06P1N8A6L00	1624022	98	CA-07P1N128007	1619719	86	
A-INL-M16-S-S	1425176	692	A-INLE-PG13,5-N-S	1411278	691	CA-06P1N8A6Y00	1619874	96	CA-07P1N128007S	1619529	84	
A-INL-M20-N-S	1411242	688	A-INLE-PG16-N-S	1411279	691	CA-06P1N8A6Z00	1619900	94	CA-07P1N128008	1619654	86	
A-INL-M20-P-BK	1411215	686	A-INLE-PG21-N-S	1411280	691	CA-06P1N8A8006	1619747	86	CA-07P1N128008S	1619503	84	
A-INL-M20-P-GY	1411207	686	A-INLE-PG29-N-S	1411281	691	CA-06P1N8A8006S	1619576	84	CA-07P1N1280DN	1619771	86	
A-INL-M20-P-LG	1414570	686	A-INLE-PG36-N-S	1411282	691	CA-06P1N8A8007	1619721	86	CA-07P1N1280DNS	1619600	84	
A-INL-M20-S-S	1411249	692	A-INLE-PG7-N-S	1411275	691	CA-06P1N8A8007S	1619531	84	CA-07P1N129006	1620140	88	
A-INL-M25-N-S	1411243	688	A-INLE-PG9-N-S	1411276	691	CA-06P1N8A8008	1619656	86	CA-07P1N129007	1620114	88	
A-INL-M25-P-BK	1411216	686	A-INR-PG16/13-N-NS-S	1415216	701	CA-06P1N8A8008S	1619505	84	CA-07P1N129008	1620041	88	
A-INL-M25-P-GY	1411208	686	A-INR-PG21/16-N-NS-S	1415217	701	CA-06P1N8A800DN	1619773	86	CA-07P1N1290DN	1620167	88	
A-INL-M25-P-LG	1417661	686	A-INR-PG29/21-N-NS-S	1415218	701	CA-06P1N8A80DNS	1619602	84	CA-07P1N12HZ00	1619846	102	
A-INL-M25-S-S	1411250	692	A-INSP-M12-68N-P-BK	1045816	702	CA-06P1N8A9006	1620142	88	CA-07P1N12T006	1620286	92	
A-INL-M32-N-S	1411244	686	A-INSP-M12-68N-P-LG	1045815	702	CA-06P1N8A9007	1620116	88	CA-07P1N12T006S	1619419	90	
A-INL-M32-P-BK	1411217	686	A-INSP-M16-68N-P-BK	1045817	702	CA-06P1N8A9007S	1620043	88	CA-07P1N12T007	1620257	92	
A-INL-M32-P-GY	1411209	686	A-INSP-M16-68N-P-LG	1045818	702	CA-06P1N8A90DN	1620169	88	CA-07P1N12T007S	1619393	90	
A-INL-M32-P-LG	1417662	686	A-INSP-M20-65N-P-BK	1415206	702	CA-06P1N8AHZ00	1619848	102	CA-07P1N12T008	1620207	92	
A-INL-M32-S-S	1411251	692	A-INSP-M20-68N-P-LG	1424519	702	CA-06P1N8AT006	1620288	92	CA-07P1N12T008S	1619365	90	
A-INL-M40-N-S	1411246	688	A-INSP-M25-65N-P-BK	1415207	702	CA-06P1N8AT006S	1619421	90	CA-07P1N12T0DN	1619338	92	
A-INL-M40-P-BK	1411218	686	A-INSP-M25-68N-P-LG	1424520	702	CA-06P1N8AT007	1620259	92	CA-07P1N12T0DNS	1619445	90	
A-INL-M40-P-GY	1411210	686	A-INSP-M32-65N-P-BK	1415208	702	CA-06P1N8AT007S	1619395	90	CA-07P1N8A2S00	1619986	100	
A-INL-M40-P-LG	1417664	686	A-INSP-M32-68N-P-LG	1424521	702	CA-06P1N8AT008	1620209	92	CA-07P1N8A6L00	1624023	98	
A-INL-M40-S-S	1411252	692	A-INSP-M40-65N-P-BK	1415210	702	CA-06P1N8AT008S	1619367	90	CA-07P1N8A6Y00	1619870	96	
A-INL-M50-N-S	1411247	688	A-INSP-M40-68N-P-LG	1424522	702	CA-06P1N8AT0DN	1619340	92	CA-07P1N8A6Z00	1619896	94	
A-INL-M50-P-BK	1411219	686	A-INSP-PG11-65N-P-BK	1047271	703	CA-06P1N8AT0DNS	1619447	90	CA-07P1N8A8006	1619743	86	
A-INL-M50-P-GY	1411211	686	A-INSP-PG11-65N-P-LG	1047270	703	CA-06S1N122S00	1619993	100	CA-07P1N8A8006S	1619572	84	
A-INL-M50-P-LG	1417665	686	A-INSP-PG13-65N-P-BK	1046790	703	CA-06S1N126L00	1624045	98	CA-07P1N8A8007	1619717	86	
A-INL-M50-S-S	1411253	692	A-INSP-PG13-65N-P-LG	1046792	703	CA-06S1N126Y00	1619877	96	CA-07P1N8A8007S	1619527	84	
A-INL-M63-N-S	1411248	688	A-INSP-PG16-65N-P-BK	1415213	703	CA-06S1N126Z00	1619903	94	CA-07P1N8A8008	1619652	86	
A-INL-M63-P-BK	1411220	686	A-INSP-PG16-65N-P-LG	1424523	703	CA-06P1N128006	1619750	86	CA-07P1N8A8008S	1619501	84	
A-INL-M63-P-GY	1411212	686	A-INSP-PG21-65N-P-BK	1415214	703	CA-06S1N128006S	1619579	84	CA-07P1N8A80DN	1619769	86	
A-INL-M63-P-LG	1417666	686	A-INSP-PG21-65N-P-LG	1424524	703	CA-06S1N128007	1619724	86	CA-07P1N8A80DNS	1619598	84	
A-INL-M63-S-S	1411254	692	A-INSP-PG29-65N-P-BK	1415215	703	CA-06S1N128007S	1619534	84	CA-07P1N8A9006	1620138	88	
A-INL-PG11-N-S	1411257	689	A-INSP-PG29-65N-P-LG	1424525	703	CA-06S1N128008	1619659	86	CA-07P1N8A9007	1620080	88	
A-INL-PG11-P-BK	1424560	687	A-INSP-PG7-65N-P-BK	1047561	703	CA-06S1N128008S	1619508	84	CA-07P1N8A9008	1620037	88	
A-INL-PG11-P-GY	1411223	687	A-INSP-PG7-65N-P-LG	1047562	703	CA-06S1N1280DN	1619776	86	CA-07P1N8A90DN	1620165	88	
A-INL-PG11-P-LG	1424550	687	A-INSP-PG9-65N-P-BK	1047272	703	CA-06S1N1280DNS	1619605	84	CA-07P1N8AHZ00	1619844	102	
A-INL-PG13,5-N-S	1411259	689	A-INSP-PG9-65N-P-LG	1047273	703	CA-06S1N129006	1620145	88	CA-07P1N8AT006	1620284	92	
A-INL-PG13,5-P-BK	1424561	687	ALU-SB	1404531	480	CA-06S1N129007	1620119	88	CA-07P1N8AT006S	1619417	90	
A-INL-PG13,5-P-GY	1411224	687	ASI CC ADR	2741338	441	CA-06S1N129008	1620046	88	CA-07P1N8AT007	1620255	92	
A-INL-PG13,5-P-LG	1424551	687	ASI CC ADR CAB CINCH	2741341	442	CA-06S1N1290DN	1620172	88	CA-07P1N8AT007S	1619391	90	
A-INL-PG16-N-S	1411260	689				CA-06S1N12HZ00	1619851	102	CA-07P1N8AT008	1620191	92	
A-INL-PG16-P-BK	1424562	687				CA-06S1N12T006	1620291	92	CA-07P1N8AT008S	1619363	90	
A-INL-PG16-P-GY	1411225	687				CA-06S1N12T006S	1619424	90	CA-07P1N8AT0DN	1619336	92	
A-INL-PG16-P-LG	1424552	687				CA-06S1N12T007	1620262	92	CA-07P1N8AT0DNS	1619443	90	
A-INL-PG21-N-S	1411262	689				CA-06S1N12T007S	1619398	90	CA-07S1N122S00	1619989	100	
A-INL-PG21-P-BK	1424563	687				CA-06S1N12T008	1620212	92	CA-07S1N126L00	1624047	98	
A-INL-PG21-P-GY	1411226	687				CA-06S1N12T008S	1619372	90	CA-07S1N126Y00	1619873	94	
A-INL-PG21-P-LG	1424553	687				CA-06S1N12T0DN	1619343	92	CA-07S1N126Z00	1619899	96	
A-INL-PG29-N-S	1411263	689				CA-06S1N12T0DNS	1619450	90	CA-07S1N128006	1619746	86	
A-INL-PG29-P-BK	1424564	687	BMKL 64X16 WH	0821807	442	CA-06S1N8A2S00	1619991	100	CA-07S1N128006S	1619575	84	
A-INL-PG29-P-GY	1411227	687				CA-06S1N8A6L00	1624030	98	CA-07S1N128007	1619720	86	
A-INL-PG29-P-LG	1424554	687				CA-06S1N8A6Y00	1619875	96	CA-07S1N128007S	1619530	84	
A-INL-PG36-N-S	1411264	689				CA-06S1N8A6Z00	1619901	94	CA-07S1N128008	1619655	86	
A-INL-PG36-P-BK	1424565	687				CA-06S1N8A8006	1619748	86	CA-07S1N128008S	1619504	84	
A-INL-PG36-P-GY	1411228	687	CA-06P1N122S00	1619992	100	CA-06S1N8A8006S	1619577	84	CA-07S1N1280DN	1619772	86	
A-INL-PG36-P-LG	1424555	687										

Type	Order No.	Page	Type	Order No.	Page	Type	Order No.	Page	Type	Order No.	Page
CA-07S1N129008	1620042	88	CA-09P1N8AT006	1620280	92	CA-12F2N8A9504	1619999	111	CA-12S1N126Y00	1619865	96
CA-07S1N12900DN	1620168	88	CA-09P1N8AT006S	1619413	90	CA-12F2N8A950DU	1620018	111	CA-12S1N126Z00	1619891	94
CA-07S1N12HZ00	1619847	102	CA-09P1N8AT007	1620251	92	CA-12M1N8A8504	1619624	110	CA-12S1N128006	1619738	86
CA-07S1N12T006	1620287	92	CA-09P1N8AT007S	1619387	90	CA-12M1N8A8502S	1619465	110	CA-12S1N128006S	1619567	84
CA-07S1N12T006S	1619420	90	CA-09P1N8AT008	1620187	92	CA-12M1N8A8503	1619615	110	CA-12S1N128007	1619710	86
CA-07S1N12T007	1620258	92	CA-09P1N8AT008S	1619359	90	CA-12M1N8A8503S	1619459	110	CA-12S1N128007S	1619522	84
CA-07S1N12T007S	1619394	90	CA-09P1N8AT00DN	1619332	92	CA-12M1N8A8504	1619609	110	CA-12S1N128008	1619647	86
CA-07S1N12T008	1620208	92	CA-09P1N8AT00DNS	1619439	90	CA-12M1N8A8504S	1619453	110	CA-12S1N128008S	1619496	84
CA-07S1N12T008S	1619366	90	CA-09S1N122S00	1619973	100	CA-12M1N8A85DU	1619630	110	CA-12S1N1280DN	1619764	86
CA-07S1N12T00DN	1619339	92	CA-09S1N126L00	1624049	98	CA-12M1N8A85DUS	1619471	110	CA-12S1N1280DNS	1619593	84
CA-07S1N12T00DNS	1619446	90	CA-09S1N126Y00	1619869	96	CA-12M1N8A9502	1620008	111	CA-12S1N129006	1620133	88
CA-07S1N8A2S00	1619987	100	CA-09S1N126Z00	1619895	94	CA-12M1N8A9503	1620002	111	CA-12S1N129007	1620075	88
CA-07S1N8A6L00	1624031	98	CA-09S1N128006	1619742	86	CA-12M1N8A9504	1619996	111	CA-12S1N129008	1620032	88
CA-07S1N8A6Y00	1619871	96	CA-09S1N128006S	1619571	84	CA-12M1N8A95DU	1620015	111	CA-12S1N12900DN	1620160	88
CA-07S1N8A6Z00	1619897	94	CA-09S1N128007	1619716	86	CA-12M2N8A8502	1619626	110	CA-12S1N12HZ00	1619790	102
CA-07S1N8A8006	1619744	86	CA-09S1N128007S	1619526	84	CA-12M2N8A8502S	1619467	110	CA-12S1N12T006	1620279	92
CA-07S1N8A8006S	1619573	84	CA-09S1N128008	1619651	86	CA-12M2N8A8503	1619617	110	CA-12S1N12T006S	1619412	90
CA-07S1N8A8007	1619718	86	CA-09S1N128008S	1619500	84	CA-12M2N8A8503S	1619461	110	CA-12S1N12T007	1620250	92
CA-07S1N8A8007S	1619528	84	CA-09S1N12800DN	1619768	86	CA-12M2N8A8504	1619611	110	CA-12S1N12T007S	1619386	90
CA-07S1N8A8008	1619653	86	CA-09S1N12800DNS	1619597	84	CA-12M2N8A8504S	1619455	110	CA-12S1N12T008	1620186	92
CA-07S1N8A8008S	1619502	84	CA-09S1N129006	1620137	88	CA-12M2N8A85DU	1619632	110	CA-12S1N12T008S	1619358	90
CA-07S1N8A800DN	1619770	86	CA-09S1N129007	1620079	88	CA-12M2N8A85DUS	1619473	110	CA-12S1N12T00DN	1619331	92
CA-07S1N8A800DNS	1619599	84	CA-09S1N129008	1620036	88	CA-12M2N8A9502	1620010	111	CA-12S1N12T00DNS	1619438	90
CA-07S1N8A9006	1620139	88	CA-09S1N12900DN	1620164	88	CA-12M2N8A9503	1620004	111	CA-12S1N8A2S00	1619967	100
CA-07S1N8A9007	1620081	88	CA-09S1N12HZ00	1619843	102	CA-12M2N8A9504	1619998	111	CA-12S1N8A6L00	1624033	98
CA-07S1N8A9008	1620038	88	CA-09S1N12T006	1620283	92	CA-12M2N8A95DU	1620017	111	CA-12S1N8A6Y00	1619863	96
CA-07S1N8A900DN	1620166	88	CA-09S1N12T006S	1619416	90	CA-12P1N122S00	1619968	100	CA-12S1N8A6Z00	1619889	94
CA-07S1N8AHZ00	1619845	102	CA-09S1N12T007	1620254	92	CA-12P1N126L00	1624050	98	CA-12S1N8A8006	1619736	86
CA-07S1N8AT006	1620285	92	CA-09S1N12T007S	1619390	90	CA-12P1N126Y00	1619864	96	CA-12S1N8A8006S	1619547	84
CA-07S1N8AT006S	1619418	90	CA-09S1N12T008	1620190	92	CA-12P1N126Z00	1619890	94	CA-12S1N8A8007	1619708	86
CA-07S1N8AT007	1620256	92	CA-09S1N12T008S	1619362	90	CA-12P1N128006	1619737	86	CA-12S1N8A8007S	1619520	84
CA-07S1N8AT007S	1619392	90	CA-09S1N12T00DN	1619335	92	CA-12P1N128006S	1619548	84	CA-12S1N8A8008	1619645	86
CA-07S1N8AT008	1620192	92	CA-09S1N12T00DNS	1619442	90	CA-12P1N128007	1619709	86	CA-12S1N8A8008S	1619489	84
CA-07S1N8AT008S	1619364	90	CA-09S1N8A2S00	1619971	100	CA-12P1N128007S	1619521	84	CA-12S1N8A80DN	1619762	86
CA-07S1N8AT00DN	1619337	92	CA-09S1N8A6L00	1624032	98	CA-12P1N128008	1619646	86	CA-12S1N8A80DNS	1619591	84
CA-07S1N8AT00DNS	1619444	90	CA-09S1N8A6Y00	1619867	96	CA-12P1N128008S	1619495	84	CA-12S1N8A9006	1620131	88
CA-09P1N122S00	1619972	100	CA-09S1N8A6Z00	1619893	94	CA-12P1N12800DN	1619763	86	CA-12S1N8A9007	1620073	88
CA-09P1N126L00	1624048	98	CA-09S1N8A8006	1619740	86	CA-12P1N12800DNS	1619592	84	CA-12S1N8A9008	1620030	88
CA-09P1N126Y00	1619868	96	CA-09S1N8A8006S	1619569	84	CA-12P1N129006	1620132	88	CA-12S1N8A90DN	1620158	88
CA-09P1N126Z00	1619894	94	CA-09S1N8A8007	1619714	86	CA-12P1N129007	1620074	88	CA-12S1N8AHZ00	1619788	102
CA-09P1N128006	1619741	86	CA-09S1N8A8007S	1619524	84	CA-12P1N129008	1620031	88	CA-12S1N8AT006	1620277	92
CA-09P1N128006S	1619570	84	CA-09S1N8A8008	1619649	86	CA-12P1N12900DN	1620159	88	CA-12S1N8AT006S	1619410	90
CA-09P1N128007	1619715	86	CA-09S1N8A8008S	1619498	84	CA-12P1N12A000	1621741	104	CA-12S1N8AT007	1620248	92
CA-09P1N128007S	1619525	84	CA-09S1N8A800DN	1619766	86	CA-12P1N12HZ00	1619789	102	CA-12S1N8AT007S	1619384	90
CA-09P1N128008	1619650	86	CA-09S1N8A800DNS	1619595	84	CA-12P1N12T006	1620278	92	CA-12S1N8AT008	1620184	92
CA-09P1N128008S	1619499	84	CA-09S1N8A9006	1620135	88	CA-12P1N12T006S	1619411	90	CA-12S1N8AT008S	1619356	90
CA-09P1N12800DN	1619767	86	CA-09S1N8A9007	1620077	88	CA-12P1N12T007	1620249	92	CA-12S1N8AT00DN	1620303	92
CA-09P1N12800DNS	1619596	84	CA-09S1N8A9008	1620034	88	CA-12P1N12T007S	1619385	90	CA-12S1N8AT00DNS	1619436	90
CA-09P1N129006	1620136	88	CA-09S1N8A900DN	1620162	88	CA-12P1N12T008	1620185	92	CA-17F1N8A8502	1619623	110
CA-09P1N129007	1620078	88	CA-09S1N8AHZ00	1619841	102	CA-12P1N12T008S	1619357	90	CA-17F1N8A8502S	1619464	110
CA-09P1N129008	1620203	88	CA-09S1N8AT006	1620281	92	CA-12P1N12T00DN	1619330	92	CA-17F1N8A8503	1619614	110
CA-09P1N12900DN	1620163	88	CA-09S1N8AT006S	1619414	90	CA-12P1N12T00DNS	1619437	90	CA-17F1N8A8503S	1619458	110
CA-09P1N12AD00	1621746	104	CA-09S1N8AT007	1620252	92	CA-12P1N8A2S00	1619966	100	CA-17F1N8A8504	1619608	110
CA-09P1N12HZ00	1619842	102	CA-09S1N8AT007S	1619388	90	CA-12P1N8A6L00	1624026	96	CA-17F1N8A8504S	1619452	110
CA-09P1N12T006	1620282	92	CA-09S1N8AT008	1620188	92	CA-12P1N8A6Y00	1619862	98	CA-17F1N8A85DU	1619629	110
CA-09P1N12T006S	1619415	90	CA-09S1N8AT008S	1619360	90	CA-12P1N8A6Z00	1619888	94	CA-17F1N8A85DUS	1619470	110
CA-09P1N12T007	1620253	92	CA-09S1N8AT00DN	1619333	92	CA-12P1N8A8006	1619735	86	CA-17F1N8A9502	1620007	111
CA-09P1N12T007S	1619389	90	CA-09S1N8AT00DNS	1619440	90	CA-12P1N8A8006S	1619546	84	CA-17F1N8A9503	1620001	111
CA-09P1N12T008	1620189	92	CA-12F1N8A8502	1619625	110	CA-12P1N8A8007	1619707	86	CA-17F1N8A9504	1619995	111
CA-09P1N12T008S	1619361	90	CA-12F1N8A8502S	1619466	110	CA-12P1N8A8007S	1619519	84	CA-17F1N8A95DU	1620014	111
CA-09P1N12T00DN	1619334	92	CA-12F1N8A8503	1619616	110	CA-12P1N8A8008	1619644	86	CA-17M1N8A8502	1619619	110
CA-09P1N12T00DNS	1619441	90	CA-12F1N8A8503S	1619460	110	CA-12P1N8A8008S	1619488	84	CA-17M1N8A8502S	1619463	110
CA-09P1N8A2S00	1619970	100	CA-12F1N8A8504	1619610	110	CA-12P1N8A800DN	1619761	86	CA-17M1N8A8503	1619613	110
CA-09P1N8A6L00	1624024	98	CA-12F1N8A8504S	1619454	110	CA-12P1N8A800DNS	1619590	84	CA-17M1N8A8503S	1619457	110
CA-09P1N8A6Y00	1619866	96	CA-12F1N8A85DU	1619631	110	CA-12P1N8A9006	1620130	88	CA-17M1N8A8504	1619607	110
CA-09P1N8A6Z00	1619892	94	CA-12F1N8A85DUS	1619472	110	CA-12P1N8A9007	1620072	88	CA-17M1N8A8504S	1619451	110
CA-09P1N8A8006	1619739	86	CA-12F1N8A9502	1620009	111	CA-12P1N8A9008	1620029	88	CA-17M1N8A85DU	1619628	110
CA-09P1N8A8006S	1619568	84	CA-12F1N8A9503	1620003	111	CA-12P1N8A900DN	1620157	88	CA-17M1N8A85DUS	1619469	110
CA-09P1N8A8007	1619711	86	CA-12F1N8A9504	1619997	111	CA-12P1N8AAD00	1621738	104	CA-17M1N8A9502	1620006	111
CA-09P1N8A8007S	1619523	84	CA-12F1N8A95DU	1620016	111	CA-12P1N8AHZ00	1619787	102	CA-17M1N8A9503	1620000	111
CA-09P1N8A8008	1619648	86	CA-12F2N8A8502	1619627	110	CA-12P1N8AT006	1620276	92	CA-17M1N8A9504	1619994	111
CA-09P1N8A8008S	1619497	84	CA-12F2N8A8502S	1619468	110	CA-12P1N8AT006S	1619409	90	CA-17M1N8A95DU	1620013	111
CA-09P1N8A80DN	1619765	86	CA-12F2N8								

Index

Alphabetical

Type	Order No.	Page	Type	Order No.	Page	Type	Order No.	Page	Type	Order No.	Page
CA-17P1N128008	1619638	87	CA-17S1N8A80DNS	1619583	85	CA-1RP1N8AHZ00	1624020	103	CES-LRG-BK-15	0801619	678
CA-17P1N128008S	1619482	85	CA-17S1N8A9006	1620213	89	CA-1RP1N8AT006	1624076	93	CES-LRG-BK-16	0801621	678
CA-17P1N12800DN	1619755	87	CA-17S1N8A9007	1620050	89	CA-1RP1N8AT006S	1624085	91	CES-LRG-BK-17	0801624	678
CA-17P1N12800DNS	1619584	85	CA-17S1N8A9008	1620022	89	CA-1RP1N8AT007	1624077	93	CES-LRG-BK-18	0801626	678
CA-17P1N129006	1620124	89	CA-17S1N8A900DN	1620149	89	CA-1RP1N8AT007S	1624086	91	CES-LRG-BK-19	0801629	678
CA-17P1N129007	1620051	89	CA-17S1N8AHZ00	1619780	103	CA-1RP1N8AT008	1624078	93	CES-LRG-BK-20	0801631	678
CA-17P1N129008	1620023	89	CA-17S1N8AT006	1620266	93	CA-1RP1N8AT008S	1624087	91	CES-LRG-BK-21	0801634	678
CA-17P1N12900DN	1620150	89	CA-17S1N8AT006S	1619402	91	CA-1RP1N8AT00DN	1624075	93	CES-LRG-BK-22	0801637	678
CA-17P1N12AD00	1621745	104	CA-17S1N8AT007	1620216	93	CA-1RP1N8AT00DNS	1624084	91	CES-LRG-BK-23	0801638	678
CA-17P1N12HZ00	1619781	103	CA-17S1N8AT007S	1619376	91	CA-1RS1N8A2S00	1624015	101	CES-LRG-BK-24	0801639	678
CA-17P1N12T006	1620267	93	CA-17S1N8AT008	1620176	93	CA-1RS1N8A2L00	1623629	99	CES-LRG-BK-25	0801640	678
CA-17P1N12T006S	1619403	91	CA-17S1N8AT008S	1619347	91	CA-1RS1N8A6Y00	1624017	97	CES-LRG-BK-26	0801643	678
CA-17P1N12T007	1620217	93	CA-17S1N8AT00DN	1620295	93	CA-1RS1N8A6Z00	1624019	95	CES-LRG-BK-27	0801644	678
CA-17P1N12T007S	1619377	91	CA-17S1N8AT00DNS	1619428	91	CA-1RS1N8A8006	1623844	87	CES-LRG-BK-28	0801646	678
CA-17P1N12T008	1620177	93	CA-19P1N122S00	1619956	101	CA-1RS1N8A8006S	1623836	85	CES-LRG-BK-29	0801648	678
CA-17P1N12T008S	1619348	91	CA-19P1N126L00	1624057	99	CA-1RS1N8A8007	1623842	87	CES-LRG-BK-30	0801650	678
CA-17P1N12T00DN	1620296	93	CA-19P1N126Y00	1619852	97	CA-1RS1N8A8007S	1623834	85	CES-LRG-BK-31	0801653	678
CA-17P1N12T00DNS	1619429	91	CA-19P1N126Z00	1619878	95	CA-1RS1N8A8008	1623840	87	CES-LRG-BK-32	0801654	678
CA-17P1N8A2S00	1619958	101	CA-19P1N128006	1619725	87	CA-1RS1N8A8008S	1623832	85	CES-LRG-BK-33	0801656	678
CA-17P1N8A6L00	1624029	99	CA-19P1N128006S	1619536	85	CA-1RS1N8A80DN	1623846	87	CES-LTPG-GY	0801716	680
CA-17P1N8A6Y00	1619854	97	CA-19P1N128007	1619660	87	CA-1RS1N8A80DNS	1623838	85	CES-LTPG-GY-15	0801687	680
CA-17P1N8A6Z00	1619880	95	CA-19P1N128007S	1619509	85	CA-1RS1N8A9006	1624009	89	CES-LTPG-GY-16	0801688	680
CA-17P1N8A8006	1619727	87	CA-19P1N128008	1619634	87	CA-1RS1N8A9007	1624008	89	CES-LTPG-GY-17	0801689	680
CA-17P1N8A8006S	1619538	85	CA-19P1N128008S	1619478	85	CA-1RS1N8A9008	1624007	89	CES-LTPG-GY-18	0801690	680
CA-17P1N8A8007	1619699	87	CA-19P1N1280DN	1619751	87	CA-1RS1N8A90DN	1624006	89	CES-LTPG-GY-19	0801691	680
CA-17P1N8A8007S	1619511	85	CA-19P1N1280DNS	1619580	85	CA-1RS1N8AHZ00	1624021	103	CES-LTPG-GY-20	0801692	680
CA-17P1N8A8008	1619636	87	CA-19P1N129006	1620120	89	CA-1RS1N8AT006	1624072	93	CES-LTPG-GY-21	0801693	680
CA-17P1N8A8008S	1619480	85	CA-19P1N129007	1620047	89	CA-1RS1N8AT006S	1624081	91	CES-LTPG-GY-22	0801695	680
CA-17P1N8A80DN	1619753	87	CA-19P1N129008	1620019	89	CA-1RS1N8AT007	1624073	93	CES-LTPG-GY-23	0801696	680
CA-17P1N8A80DNS	1619582	85	CA-19P1N1290DN	1620146	89	CA-1RS1N8AT007S	1624082	91	CES-LTPG-GY-24	0801697	680
CA-17P1N8A9006	1620122	89	CA-19P1N12HZ00	1619777	103	CA-1RS1N8AT008	1624074	93	CES-LTPG-GY-25	0801698	680
CA-17P1N8A9007	1620049	89	CA-19P1N12T006	1620263	93	CA-1RS1N8AT008S	1624083	91	CES-LTPG-GY-26	0801699	680
CA-17P1N8A9008	1620021	89	CA-19P1N12T006S	1619399	91	CA-1RS1N8AT00DN	1624071	93	CES-LTPG-GY-27	0801700	680
CA-17P1N8A90DN	1620148	89	CA-19P1N12T007	1620213	93	CA-1RS1N8AT00DNS	1624080	91	CES-LTPG-GY-28	0801701	680
CA-17P1N8AA000	1621744	104	CA-19P1N12T007S	1619373	91	CA-Z0001	1620699	179	CES-LTPG-GY-29	0801702	680
CA-17P1N8AHZ00	1619779	103	CA-19P1N12T008	1620133	93	CA-Z0077	1627224	182	CES-LTPG-GY-30	0801703	680
CA-17P1N8AT006	1620265	93	CA-19P1N12T008S	1619344	91	CA-Z0110	1620700	180	CES-LTPG-GY-31	0801705	680
CA-17P1N8AT006S	1619401	91	CA-19P1N12T00DN	1620292	93	CA-Z0111	1620701	180	CES-LTPG-GY-32	0801706	680
CA-17P1N8AT007	1620215	93	CA-19P1N12T00DNS	1619425	91	CA-Z0112	1620702	180	CES-LTPG-GY-33	0801707	680
CA-17P1N8AT007S	1619375	91	CA-19S1N122S00	1619957	101	CA-Z0120	1620704	180	CES-SFFS-H	0801728	677
CA-17P1N8AT008	1620175	93	CA-19S1N126L00	1624058	99	CA-Z0121	1620705	180	CES-SRC-BK	0801718	678
CA-17P1N8AT008S	1619346	91	CA-19S1N126Y00	1619853	97	CA-Z0122	1620706	180	CES-SRG-BK	0801670	678
CA-17P1N8AT0DN	1620294	93	CA-19S1N126Z00	1619879	95	CC-0,8-ST-0,34-MS AU	1452372	45	CES-SRG-BK-10	0801620	678
CA-17P1N8AT0DNS	1619427	91	CA-19S1N128006	1619726	87	CC-1,0-ST-0,34-MS AU	1452356	45	CES-SRG-BK-11	0801618	678
CA-17S1N122S00	1619961	101	CA-19S1N128006S	1619537	85	CC0,6-TS-0,34M AU	1423643	27	CES-SRG-BK-12	0801617	678
CA-17S1N126L00	1624056	99	CA-19S1N128007	1619661	87	CC1,0-TS-0,34F AU	1064401	27	CES-SRG-BK-13	0801616	678
CA-17S1N126Y00	1619857	97	CA-19S1N128007S	1619510	85	CC1,0-TS-0,34M AU	1064400	27	CES-SRG-BK-14	0801615	678
CA-17S1N126Z00	1619883	95	CA-19S1N128008	1619635	87	CC1,0-TS-1,00F AU	1423646	27	CES-SRG-BK-15	1410563	678
CA-17S1N128006	1619730	87	CA-19S1N128008S	1619479	85	CC1,0-TS-1,00M AU	1423645	27	CES-SRG-BK-16	1410576	678
CA-17S1N128006S	1619541	85	CA-19S1N1280DN	1619752	87	CC1,5-TS-2,10F K/L AU	1029396	278	CES-SRG-BK-17	1410589	678
CA-17S1N128007	1619702	87	CA-19S1N1280DNS	1619581	85	CC1,5-TS-2,10F S/T AU	1029398	278	CES-SRG-BK-1ASI-L	1410042	679
CA-17S1N128007S	1619514	85	CA-19S1N129006	1620121	89	CC1,5-TS-2,10FFE K/L AU	1029401	278	CES-SRG-BK-1ASI-R	0801667	679
CA-17S1N128008	1619639	87	CA-19S1N129007	1620048	89	CC1,5-TS-2,10FFE S/T AU	1029400	278	CES-SRG-BK-2	0801635	678
CA-17S1N128008S	1619483	85	CA-19S1N129008	1620020	89	CC1,5-TS-2,10M AU	1029394	278	CES-SRG-BK-2ASI-LL	1410055	679
CA-17S1N12800DN	1619756	87	CA-19S1N1290DN	1620147	89	CC1,5-TS-2,10MPE AU	1029398	278	CES-SRG-BK-2ASI-LR	0801669	679
CA-17S1N12800DNS	1619585	85	CA-19S1N12HZ00	1619778	103	CC1,5-TS-2,50F K/L AU	1029392	278	CES-SRG-BK-2ASI-RR	0801668	679
CA-17S1N129006	1620125	89	CA-19S1N12T006	1620264	93	CC1,5-TS-2,50F S/T AU	1029390	278	CES-SRG-BK-2X3	1410398	679
CA-17S1N129007	1620052	89	CA-19S1N12T006S	1619400	91	CC1,5-TS-2,50FFE K/L AU	1029393	278	CES-SRG-BK-2X4	1410408	679
CA-17S1N129008	1620024	89	CA-19S1N12T007	1620214	93	CC1,5-TS-2,50FFE S/T AU	1029391	278	CES-SRG-BK-2X5	0801657	679
CA-17S1N12900DN	1620151	89	CA-19S1N12T007S	1619374	91	CC1,5-TS-2,50M AU	1029388	278	CES-SRG-BK-2X6	0801664	679
CA-17S1N12HZ00	1619782	103	CA-19S1N12T008	1620174	93	CC1,5-TS-2,50MPE AU	1029389	278	CES-SRG-BK-2X7	1410084	679
CA-17S1N12T006	1620268	93	CA-19S1N12T008S	1619345	91	CES-B10-HFFS-PLBK	0801663	676	CES-SRG-BK-2X8	1410097	679
CA-17S1N12T006S	1619404	91	CA-19S1N12T00DN	1620293	93	CES-B10-SF-PLBK	0801655	677	CES-SRG-BK-2X9	1410411	679
CA-17S1N12T007	1620218	93	CA-19S1N12T00DNS	1619426	91	CES-B10-SFC-M-15,6	1423743	677	CES-SRG-BK-3	0801633	678
CA-17S1N12T007S	1619378	91	CA-1RP1N8A2S00	1624014	101	CES-B10-SFFS-PLBK	0801660	677	CES-SRG-BK-4	0801632	678
CA-17S1N12T008	1620178	93	CA-1RP1N8A6L00	1623630	99	CES-B10-WRG-BK	0801725	676	CES-SRG-BK-4X3	0801665	679
CA-17S1N12T008S	1619349	91	CA-1RP1N8A6Y00	1624016	97	CES-B16-8XSRC-BK	1411073	677	CES-SRG-BK-4X4	0801666	679
CA-17S1N12T00DN	1620297	93	CA-1RP1N8A6Z00	1624018	95	CES-B16-HFFS-PLBK	0801662	676	CES-SRG-BK-4X5	1410107	679
CA-17S1N12T00DNS	1619430	91	CA-1RP1N8A8006	1623843	87	CES-B16-SF-PLBK	0801651	677	CES-SRG-BK-4X6	1410152	679
CA-17S1N8A2S00	1619959	101	CA-1RP1N8A8006S	1623835	85	CES-B16-SFC-M-15,6	1423744	677	CES-SRG-BK-5	0801630	678
CA-17S1N8A6L00	1624035	99	CA-1RP1N8A8007	1623841	87	CES-B16-SFFS-PLBK	0801659	677	CES-SRG-BK-6	0801628	678
CA-17S1N8A6Y00	1619855	97	CA-1RP1N8A8007S	1623833	85	CES-B16-WRG-BK	0801726	676	CES-SRG-BK-7	0801627	678
CA-17S1N8A6Z00	1619881	95	CA-1RP1N8A8008	1623839	87	CES-B24-10XSRC-BK	1411074	677	CES-SRG-BK-8	0801625	678
CA-17S1N8A8006	1619728	85	CA-1RP1N8A8008S	1623831	85	CES-B24-HFFS-PLBK	0801661	676	CES-SRG-BK-9	0801622	678
CA-17S1N8A8006S	1619539	85	CA-1RP1N8A800DN	1623845	87	CES-B24-SF-PLBK	0801647	677	CES-STPG-GY	0801715	680
CA-17S1N8A8											

Type	Order No.	Page	Type	Order No.	Page	Type	Order No.	Page	Type	Order No.	Page
CES-STPG-GY-15	1410521	680	CK2,5-ED-1,50BU AU	1674820	509	CUC-PPC-C2ZNI-SX/24FKP5:WO	1032276	364	EO-D/UT/GN	0804001	715
CES-STPG-GY-16	1410534	680	CK2,5-ED-1,50ST AG	1663608	509	CUC-STD-C1PGN-S/R4E8:1	1414400	372	EO-D/UT/LED	0804003	715
CES-STPG-GY-17	1410547	680	CK2,5-ED-1,50ST AU	1674778	509	CUC-STD-C1PGN-S/R4EA:1	1414402	372	EO-D/UT/LED/GN	0804004	715
CES-STPG-GY-1ASHL	1410068	681	CK2,5-ED-1,50ST-S AG	1663860	561	CUC-STD-C1PGY-S/R4E8:1	1414382	372	EO-E/PT/SH	0804020	717
CES-STPG-GY-1ASH-R	0801712	681	CK2,5-ED-2,50BU AG	1663682	509	CUC-STD-C1PGY-S/R4EA:1	1414395	372	EO-E/PT/SH/GN	0804021	717
CES-STPG-GY-2	0801672	680	CK2,5-ED-2,50BU AU	1674862	509	CUC-V06-C1PBK-S/R4CE:1	1414408	350	EO-E/PT/SH/LED	0804022	717
CES-STPG-GY-2ASH-LL	1410071	681	CK2,5-ED-2,50ST AG	1663611	509	CUC-V06-C1PBK-S/R4CEA:1	1414410	350	EO-E/PT/SH/LED/GN	0804023	717
CES-STPG-GY-2ASH-LR	0801714	681	CK2,5-ED-2,50ST AU	1674817	509	CUC-V06-C1PGY-S/R4CE8:1	1414383	350	EO-E/UT/SH	0804016	717
CES-STPG-GY-2ASH-RR	0801713	681	CK2,5-ED-2,50ST-S AG	1663873	561	CUC-V06-C1PGY-S/R4CEA:1	1414406	350	EO-E/UT/SH/GN	0804017	717
CES-STPG-GY-2X3	1410424	681	CK2,5-ED-3,00BU AG	1663695	509	CUC-V06-F1PGY-UBA/UBBB	1411904	453	EO-E/UT/SH/LED	0804018	717
CES-STPG-GY-2X4	1410438	681	CK2,5-ED-3,00ST AG	1663624	509	CUC-V06-F1PGY-UBB/UBAB	1411905	453	EO-E/UT/SH/LED/GN	0804019	717
CES-STPG-GY-2X5	0801708	681	CK2,5-ED-4,00BU AG	1663705	519	CUC-V14-A-SCREW-M3:20	1413987	360	EO-G/PT/SH	0804063	717
CES-STPG-GY-2X6	0801709	681	CK2,5-ED-4,00BU AU	1674846	519	CUC-V14-A1PBK-BA:50	1413979	360	EO-G/PT/SH/GN	0804064	717
CES-STPG-GY-2X7	1410110	681	CK2,5-ED-4,00ST AG	1663637	519	CUC-V14-A1PBK-PC	1413970	360	EO-G/PT/SH/LED	0804065	717
CES-STPG-GY-2X8	1410123	681	CK2,5-ED-4,00ST AU	1674794	519	CUC-V14-A1RBK-PC	1413985	360	EO-G/PT/SH/LED/GN	0804066	717
CES-STPG-GY-2X9	1410440	681	CK2,5-ED-BB	1584693	657	CUC-V14-A1ZNI-R45	1413988	360	EO-G/PT/SH/LED/S	0804070	717
CES-STPG-GY-3	0801673	680	CK4,0-ED-1,50BU AG	1663271	511	CUC-V14-A1ZNI-S180	1413989	360	EO-G/PT/SH/S	0804069	717
CES-STPG-GY-4	0801674	680	CK4,0-ED-1,50ST AG	1663239	511	CUC-V14-A3ST-SR	1413990	360	EO-G/UT/SH	0804051	717
CES-STPG-GY-4X3	0801710	681	CK4,0-ED-10,00BU AG	1586183	511	CUC-V14-C1ZNI-B/R4E8	1422662	358	EO-G/UT/SH/GN	0804052	717
CES-STPG-GY-4X4	0801711	681	CK4,0-ED-10,00ST AG	1586198	511	CUC-V14-C1ZNI-B/R4P8	1422665	358	EO-G/UT/SH/LED	0804053	717
CES-STPG-GY-4X5	1410136	681	CK4,0-ED-2,50BU AG	1663284	511	CUC-V14-C1ZNI-S/R4E8	1422661	357	EO-G/UT/SH/LED/GN	0804054	717
CES-STPG-GY-4X6	1410149	681	CK4,0-ED-2,50ST AG	1663242	511	CUC-V14-C1ZNI-S/R4P8	1422664	357	EO-G/UT/SH/LED/S	0804059	717
CES-STPG-GY-5	0801675	680	CK4,0-ED-4,00BU AG	1663297	511	CUC-V14-C1ZNI-T/R4E8	1422663	357	EO-G/UT/SH/S	0804058	717
CES-STPG-GY-6	0801676	680	CK4,0-ED-4,00ST AG	1663255	511	CUC-V14-C1ZNI-T/R4P8	1422667	357	EO-I/UT	0804087	719
CES-STPG-GY-7	0801677	680	CK4,0-ED-6,00BU AG	1663307	511	CUC-V14-F1ZNI-EM/R4B8	1413962	360	EO-I/UT/GN	0804088	719
CES-STPG-GY-8	0801679	680	CK4,0-ED-6,00ST AG	1663268	511	CUC-V14-F1ZNI-EM/R4F8	1413961	360	EO-I/UT/LED	0804089	719
CES-STPG-GY-9	0801680	680	CP QPD 4X2,5	1425950	488	CUTFOX-ES	1212621	384	EO-I/UT/LED/GN	0804090	719
CK1,6-BR-1,00BU OIC AG	1004381	667	CP-HC	1686478	656	CUTFOX-SCRJ-POF	1405247	384	EO-J/PT	0804105	719
CK1,6-BR-1,00ST OIC AG	1004380	667	CP-HC-S	1410916	656				EO-J/PT/GN	0804106	719
CK1,6-BR-2,50BU OIC AG	1004383	667	CP-QPD 3/4X1,5	1414729	480				EO-J/PT/LED	0804107	719
CK1,6-BR-2,50ST OIC AG	1004382	667	CP-QPD 5X1,5	1414760	480				EO-J/PT/LED/GN	0804108	719
CK1,6-ED-0,37BU AG	1663394	507	CP-QPD 5X2,5	1404530	488				EO-J/UT	0804099	719
CK1,6-ED-0,37BU AU	1674969	507	CP-QPD 5X6,0	1411402	494	EMLP (13X9)R	0819453	480	EO-J/UT/GN	0804100	719
CK1,6-ED-0,37ST AG	1663336	507	CRIMPFOX RC 2,5	1205448	446	ENLAR-M-KV-M16/M20	1647653	701	EO-J/UT/LED	0804101	719
CK1,6-ED-0,37ST AU	1674901	507	CRIMPFOX-1,6-ED-POF-N	1584839	668	ENLAR-M-KV-M20/M25	1647666	701	EO-J/UT/LED/GN	0804102	719
CK1,6-ED-0,50BU AG	1663404	507	CRIMPFOX-1,6/2,5-ED-4,0	1687419	669	ENLAR-M-KV-M25/M40	1647679	701	EO-K/PT	0804119	719
CK1,6-ED-0,50BU AU	1674480	507	CRIMPFOX-CX 4,52	1212094	671	ENLAR-M-KV-M32/M40	1647682	701	EO-K/PT/GN	0804120	719
CK1,6-ED-0,50ST AG	1663349	507	CRIMPFOX-M	1212072	670	EO-AB/PT/15	0804165	715	EO-K/PT/LED	0804121	719
CK1,6-ED-0,50ST AU	1672453	507	CRIMPFOX-M TC 10/DIE	1212076	670	EO-AB/PT/F	0804175	715	EO-K/PT/LED/GN	0804122	719
CK1,6-ED-0,75BU AG	1663417	507	CRIMPFOX-M TC 4/DIE	1212075	670	EO-AB/PT/LED/15	0804168	715	EO-K/UT	0804113	719
CK1,6-ED-0,75BU AU	1672440	507	CRIMPFOX-P CK 1.6 ER 2.5 OIC-L	1069228	671	EO-AB/PT/LED/F	0804171	715	EO-K/UT/GN	0804114	719
CK1,6-ED-0,75ST AG	1663352	507	CRIMPFOX-TC 10	1212114	670	EO-AB/PT/LED/S/15	0804174	715	EO-K/UT/LED	0804115	719
CK1,6-ED-0,75ST AU	1674914	507	CRIMPFOX-TC 4	1212113	670	EO-AB/PT/S/15	0804173	715	EO-K/UT/LED/GN	0804116	719
CK1,6-ED-1,00BU AG	1663420	507	CRIMPFOX-TC MP	1212510	671	EO-AB/UT/15	0804152	715	EO-L/PT/SH	0804132	716
CK1,6-ED-1,00BU AU	1674943	507	CUC-BH-M12A1PBK-A/R4BE	1414393	348	EO-AB/UT/F	0804161	715	EO-L/PT/SH/GN	0804133	716
CK1,6-ED-1,00ST AG	1663365	507	CUC-BH-M12A1PBK-S/R4BE	1414396	348	EO-AB/UT/LED/15	0804155	715	EO-L/PT/SH/LED	0804134	716
CK1,6-ED-1,00ST AU	1674888	507	CUC-BH-M12D1PBK-A/R4BE	1414397	348	EO-AB/UT/LED/F	0804157	715	EO-L/PT/SH/LED/GN	0804135	716
CK1,6-ED-1,50BU AG	1663433	507	CUC-BH-M12D1PBK-S/R4BE	1414398	348	EO-AB/UT/LED/S/15	0804160	715	EO-L/UT/SH	0804126	716
CK1,6-ED-1,50BU AU	1674930	507	CUC-DSC-C1BAU-S/DSC22	1418789	446	EO-AB/UT/S/15	0804159	715	EO-L/UT/SH/GN	0804127	716
CK1,6-ED-1,50ST AG	1663378	507	CUC-DSC-C1BAU-S/DSC24	1418786	446	EO-CF/PT	0804038	714	EO-L/UT/SH/LED	0804128	716
CK1,6-ED-1,50ST AU	1674875	507	CUC-DSC-C1BAU-S/DSC28	1418784	446	EO-CF/PT/F	0804047	714	EO-L/UT/SH/LED/GN	0804129	716
CK1,6-ED-2,50BU AG	1663446	507	CUC-DSC-C1MAU-S/DSL:100	1426073	447	EO-CF/PT/F/GN	0804048	714	EO-N/PT	0804146	718
CK1,6-ED-2,50BU AU	1674985	507	CUC-DSC-J1BAU-S/DSC22	1418790	446	EO-CF/PT/GN	0804039	714	EO-N/PT/GN	0804147	718
CK1,6-ED-2,50ST AG	1663381	507	CUC-DSC-J1BAU-S/DSC24	1418788	446	EO-CF/PT/LED	0804040	714	EO-N/PT/LED	0804148	718
CK1,6-ED-2,50ST AU	1674927	507	CUC-DSC-J1BAU-S/DSC28	1418787	446	EO-CF/PT/LED/F	0804042	714	EO-N/PT/LED/GN	0804149	718
CK1,6-ED-BB	1645888	657	CUC-DSC-J1MAU-S/DSL:100	1426074	447	EO-CF/PT/LED/F/GN	0804043	714	EO-N/UT	0804139	718
CK1,6-ED-BU-POF	1885004	668	CUC-F-D1ZNI-S/R4GC8	1419022	351	EO-CF/PT/LED/GN	0804041	714	EO-N/UT/GN	0804140	718
CK1,6-ED-ST-POF	1884995	668	CUC-F-J1ZNI-S/R4DC8	1418984	351	EO-CF/PT/LED/S	0804046	714	EO-N/UT/LED	0804142	718
CK1,6-ER-1,00BU OIC AG	1004362	667	CUC-I-D1ZNI-S/R4GC8	1041760	375	EO-CF/PT/LED/YE	1088075	714	EO-N/UT/LED/GN	0804143	718
CK1,6-ER-1,00ST OIC AG	1004360	667	CUC-I-J1ZNI-S/R4DC8	1417274	375	EO-CF/PT/S	0804045	714	EO-SI-FRAME	0804522	714
CK1,6-ER-2,50BU OIC AG	1004366	667	CUC-IND-C1ZNI-B/R4IE8	1421876	373	EO-CF/PT/YE	1088067	714	EWR	1665075	671
CK1,6-ER-2,50ST OIC AG	1004365	667	CUC-IND-C1ZNI-B/R4IP8	1421127	373	EO-CF/UT	0804024	714			
CK2,5-ED-0,37BU AU	1585647	666	CUC-IND-C1ZNI-S/R4IE8	1421607	373	EO-CF/UT/F	0804034	714			
CK2,5-ED-0,37ST AU	1585663	666	CUC-IND-C1ZNI-S/R4IP8	1421126	373	EO-CF/UT/F/GN	0804035	714			
CK2,5-ED-0,50BU AG	1663640	509	CUC-IND-C1ZNI-T/R4IE8	1421877	373	EO-CF/UT/GN	0804025	714			
CK2,5-ED-0,50BU AU	1674859	509	CUC-IND-C1ZNI-T/R4IP8	1421128	373	EO-CF/UT/LED	0804026	714			
CK2,5-ED-0,50ST AG	1663572	509	CUC-INI-C1ZNI-S/R4IE8	1421608	513	EO-CF/UT/LED/F	0804029	714			
CK2,5-ED-0,50ST AU	1674804	509	CUC-INI-C1ZNI-S/R4IP8	1421129	513	EO-CF/UT/LED/F/GN	0804030	714			
CK2,5-ED-0,5BU CUNI	1585757	668	CUC-K-J1ZNI-S/R4DC8	1419021	374	EO-CF/UT/LED/GN	0804027	714	FL CAT5 PATCH 0,3	2832250	721
CK2,5-ED-0,5BU FE	1585773	668	CUC-PP-D1PGY/R4GC8	1418094	375	EO-CF/UT/LED/S	0804033	714	FL CAT5 PATCH 0,5	2832263	721
CK2,5-ED-0,5ST CUNI	1585744	668	CUC-PP-D1PGY/R4DC8	1419024	375	EO-CF/UT/LED/YE	1088028	714	FL CAT5 PATCH 1,0	2832276	513
CK2,5-ED-0,5ST FE	1585760	668	CUC-PP-FR19:1U-I-EMPTY:24	1422978	391	EO-CF/UT/S	0804032	714	FL CAT5 PATCH 1,5	2832221	721
CK2,5-ED-0,75BU AG	1663653	509	CUC-PP-FR19:1U-I-EMPTY:24 BK	1422979	391	EO-CF/UT/YE	1088038	714	FL CAT5 PATCH 10,0	2832629	721
CK2,5-ED-0,75ST AG	1663585	509	CUC-PPC-A2RBK-PC	1424989	364	EO-D/PT	0804009	715	FL CAT5 PATCH 2,0	2832289	721
CK2,5-ED-1,00BU AG	1663666	509	CUC-PPC-C2ZNI-DC	1001432	364	EO-D/PT/GN	0804010	715	FL CAT5 PATCH 3,0	2832292	721
CK2,5-ED-1,00BU AU	1674833	509	CUC-PPC-C2ZNI-SS/24FKP5	1421785	364	EO-D/PT/LED	0804011	715	FL CAT5 PATCH 5,0	2832580	721
CK2,5-ED-1,00ST AG	1663598	509	CUC-PPC-C2ZNI-SS/24FKP5:FC	1425515	364	EO-D/PT/LED/GN	0804012	715	FL CAT5 PATCH 7,5	2832616	721
CK2,5-ED-1,00ST AU	1674781	509	CUC-PPC-C2ZNI-SX/24FKP5	1421783	364	EO-D/UT	0804000	715	FL CAT6 PATCH 0,3	2891181	

Index

Alphabetical

Type	Order No.	Page	Type	Order No.	Page	Type	Order No.	Page	Type	Order No.	Page
FL CAT6 PATCH 1.5	2891482	721	FOC-C-SCDU-GOF-SM-APC/10	1412481	379	FOC-POLISHINGFILM-AO-03.0	1407039	383	FOC-TOOL-FERRULECLEANER-1.25	1407032	382
FL CAT6 PATCH 10	2891877	721	FOC-C-SCDU-GOF-SM-PC	1411293	379	FOC-POLISHINGFILM-D-00.1	1407046	383	FOC-TOOL-FERRULECLEANER-2.50	1407029	382
FL CAT6 PATCH 12.5	2891369	721	FOC-C-SCDU-GOF-SM-PC/10	1411303	379	FOC-POLISHINGFILM-D-01.0	1407042	383	FOC-TOOL-GOF KONF SET	1411049	385
FL CAT6 PATCH 15,0	2891372	721	FOC-C-SCDU-PCF	1411305	377	FOC-POLISHINGFILM-D-09.0	1407044	383	FOC-TOOL-PCF KONF SET	1411051	385
FL CAT6 PATCH 2.0	2891589	721	FOC-C-SCRJ-GOF-MM	1411290	379	FOC-POLISHINGFILM-SK-15.0	1407034	383	FOC-TOOL-STICKCLEANER-1.25	1407000	382
FL CAT6 PATCH 20,0	2891576	721	FOC-C-SCRJ-GOF-MM/10	1411300	379	FOC-SB-FR19:1U-LCD12-OM2 GY	1418815	382	FOC-TOOL-STICKCLEANER-2.50	1407002	382
FL CAT6 PATCH 3,0	2891686	721	FOC-C-SCRJ-GOF-SM-APC	1412473	379	FOC-SB-FR19:1U-LCD12-OM4 BK	1418817	382	FOC-TOOL-STRIPPING-1HOLE-250	1407004	383
FL CAT6 PATCH 5,0	2891783	721	FOC-C-SCRJ-GOF-SM-APC/10	1412480	379	FOC-SB-FR19:1U-LCD24-OM2 GY	1418816	382	FOC-TOOL-STRIPPING-2HOLE-250	1407008	383
FL CAT6 PATCH 7.5	2891880	721	FOC-C-SCRJ-GOF-SM-PC	1411291	379	FOC-SB-FR19:1U-LCD24-OM4 BK	1418818	382	FOC-TOOL-STRIPPING-T-1	1407016	383
FL COUPLER SC-DUPLEX	2901788	388	FOC-C-SCRJ-GOF-SM-PC/10	1411301	379	FOC-SC-A-LC-A-GZ01/...	1405691	416	FOC-TOOL-STRIPPING-T-2	1407014	383
FL DUST CVR BK	2891107	388	FOC-C-SCRJ-PCF	1411304	377	FOC-SC-A-LC-A-GZ01/1	1409790	416	FOC-V06-D1PGY-S/SJBE4	1410050	356
FL DUST CVR BN	2891301	388	FOC-CRIMPSPLICE-PROTECT	1019678	381	FOC-SC-A-LC-A-GZ01/2	1400639	416	FOC-V14-C1ZNI-B/SJFP	1407902	368
FL DUST CVR BU	2891204	388	FOC-FDX20-PP-E2D6-OSA-PT9	1019680	381	FOC-SC-A-LC-A-GZ02/...	1405692	418	FOC-V14-C1ZNI-S/SJFP	1407896	367
FL DUST CVR GN	2891602	388	FOC-FDX20-PP-LCD6-MM	1019710	381	FOC-SC-A-LC-A-GZ01/1	1409791	418	FOC-V14-C1ZNI-T/SJFP	1408028	367
FL DUST CVR GY	2891505	388	FOC-FDX20-PP-LCD6-OM2-PT9	1019713	381	FOC-SC-A-LC-A-GZ02/2	1400673	418	FOC-V14-F1ZNI-EM/SJB	1413964	369
FL DUST CVR RD	2891709	388	FOC-FDX20-PP-LCD6-OM4-PT9	1019712	381	FOC-SC-A-LC-A-GZ03/...	1405693	420	FOC-V14-F1ZNI-EM/SJO	1413981	369
FL DUST CVR VT	2891806	388	FOC-FDX20-PP-LCD6-OSA-PT9	1083665	381	FOC-SC-A-LC-A-GZ03/1	1409792	420			
FL DUST CVR WH	2891903	388	FOC-FDX20-PP-LCD6-OSP-PT9	1019711	381	FOC-SC-A-LC-A-GZ03/2	1400681	420			
FL DUST CVR YE	2891408	388	FOC-FDX20-PP-LCQ6-MM	1019705	381	FOC-SC-A-LC-A-GZ04/...	1413789	415			
FL FOC PN-B-HCS-200/230	2313766	410	FOC-FDX20-PP-LCQ6-OM2-PT9	1019709	381	FOC-SC-A-LC-A-GZ04/1	1413827	415			
FL MM PATCH COUPLER LC-LC	2700312	380	FOC-FDX20-PP-LCQ6-OM4-PT9	1019708	381	FOC-SC-A-SC-A-GZ01/...	1405697	416	G-CCS-M25-M68N-PNES-BK	1076600	706
FL PATCH CCODE BK	2891194	389	FOC-FDX20-PP-LCQ6-OSP-PT9	1019707	381	FOC-FDX20-PP-LCQ6-OSP-PT9	1409798	416	G-INB-M12-S68N-PEPDS-BK	1415177	696
FL PATCH CCODE BN	2891495	389	FOC-FDX20-PP-SCD6-MM	1019686	381	FOC-SC-A-SC-A-GZ01/2	1400685	416	G-INB-M12-S68N-PEPDS-LG	1415171	696
FL PATCH CCODE BU	2891291	389	FOC-FDX20-PP-SCD6-OM2-PT9	1019700	381	FOC-SC-A-SC-A-GZ02/...	1405698	418	G-INB-M16-S68N-PEPDS-BK	1415178	696
FL PATCH CCODE GN	2891796	389	FOC-FDX20-PP-SCD6-OM4-PT9	1019698	381	FOC-SC-A-SC-A-GZ02/1	1409799	418	G-INB-M16-S68N-PEPDS-LG	1415172	696
FL PATCH CCODE GY	2891699	389	FOC-FDX20-PP-SCD6-OSP-PT9	1019692	381	FOC-SC-A-SC-A-GZ02/2	1400688	418	G-INB-M20-S68N-NEPDS-S	1415182	697
FL PATCH CCODE RD	2891893	389	FOC-FDX20-PP-STD6-MM	1019681	381	FOC-SC-A-SC-A-GZ03/...	1405699	420	G-INB-M20-S68N-PEPDS-BK	1415179	696
FL PATCH CCODE VT	2891990	389	FOC-FDX20-PP-STD6-OM1-PT9	1019684	381	FOC-SC-A-SC-A-GZ03/1	1409801	420	G-INB-M20-S68N-PEPDS-LG	1415174	696
FL PATCH CCODEYE	2891592	389	FOC-FDX20-PP-STD6-OM2-PT9	1019683	381	FOC-SC-A-SC-A-GZ03/2	1400689	420	G-INB-M25-M68N-NEPDS-S	1415183	697
FL PATCH GUARD	2891424	389	FOC-FDX20-PP-STD6-OSP-PT9	1019682	381	FOC-SC-A-SC-A-GZ04/...	1413790	414	G-INB-M25-M68N-PEPDS-BK	1415180	696
FL PATCH GUARD KEY	2891521	389	FOC-FR19:1U-20S12-LCD12-OM1	1419973	390	FOC-SC-A-SC-A-GZ04/1	1413828	414	G-INB-M25-M68N-PEPDS-LG	1415175	696
FL PATCH SAFE CLIP	2891246	389	FOC-FR19:3U	1419976	390	FOC-SC-A-SJA-GZ01/...	1409790	416	G-INB-M32-M68N-NEPDS-S	1415184	697
FL PLUG GUARD GN	2891615	388	FOC-FS-A-FS-A-GZ04/...	1406532	414	FOC-SC-A-SJA-GZ01/1	1409810	416	G-INB-M32-M68N-PEPDS-BK	1415181	696
FL PLUG GUARD KEY	2891327	388	FOC-FS-A-FS-A-GZ04/1	1409855	414	FOC-SC-A-SJA-GZ01/2	1400690	416	G-INB-M32-M68N-PEPDS-LG	1415176	696
FL PLUG GUARD RD	2891712	388	FOC-FS-A-LC-A-GZ04/...	1413787	415	FOC-SC-A-SJA-GZ02/...	1405701	418	G-INB-M40-M68N-NEPDS-S	1415185	697
FL PLUG GUARD WH	2891819	388	FOC-FS-A-LC-A-GZ04/1	1413825	415	FOC-SC-A-SJA-GZ02/1	1409811	418	G-INESR-M20-S68N-NEPDS-S	1415192	698
FL PORT GUARD	2891220	388	FOC-FS-A-SC-A-GZ04/...	1406536	414	FOC-SC-A-SJA-GZ02/2	1400691	418	G-INESR-M25-M68N-NEPDS-S	1415193	698
FL RJ45 PROTECT CAP	2832991	389	FOC-FS-A-SC-A-GZ04/1	1409857	414	FOC-SC-A-SJA-GZ03/...	1405702	420	G-INESR-M32-M68N-NEPDS-S	1415194	698
FL RJ45 PROTECT CAP GY	1065531	389	FOC-FS-A-ST-A-GZ04/...	1406335	415	FOC-SC-A-SJA-GZ03/1	1409812	420	G-INESR-M40-M68N-NEPDS-S	1415195	698
FL SM PATCH 1,0 LC-LC	2989187	406	FOC-FS-A-ST-A-GZ04/1	1409856	415	FOC-SC-A-SJA-GZ03/2	1400695	420	G-INB-M12-M68N-SNES-S	1424541	692
FL SM PATCH 1,0 LC-SC	2989190	407	FOC-HCS-RUGGED-1014/...	1402191	413	FOC-SC-A-ST-A-GZ04/...	1413791	415	G-INB-M12-S68N-NNES-S	1411160	688
FL SM PATCH 1,0 LC-ST	2989242	407	FOC-HCS-RUGGED-1014/IP20/...	2901555	412	FOC-SC-A-ST-A-GZ04/1	1413830	415	G-INB-M12-S68N-PNES-BK	1411131	686
FL SM PATCH 1,0 SC-SC	2901829	407	FOC-I-D1PGN-S/LCGCSM	1041780	375	FOC-SHINKSPLICE-PROTECT	1019676	381	G-INB-M12-S68N-PNES-GY	1411123	686
FL SM PATCH 1,0 SC-ST	2901832	407	FOC-I-D1PGR-S/SCGCSM	1041800	375	FOC-SJ-14-ST/.../...	1417723	409	G-INB-M12-S68N-PNES-LG	1417652	686
FL SM PATCH 1,0 ST-ST	2901836	407	FOC-I-D1PGY-S/MPAGC	1041820	375	FOC-SJA-A-SJA-GZ01/...	1405703	416	G-INB-M16-M68N-SNES-S	1424542	692
FL SM PATCH 2,0 LC-LC	2989284	406	FOC-I-D1PGY-S/MPBGC	1041840	375	FOC-SJA-A-SJA-GZ01/1	1409813	416	G-INB-M16-S68N-NNES-S	1411162	688
FL SM PATCH 2,0 LC-SC	2989297	407	FOC-LC-A-LC-A-GZ01/...	1405688	417	FOC-SJA-A-SJA-GZ01/2	1400697	416	G-INB-M16-S68N-PNES-BK	1411132	686
FL SM PATCH 2,0 LC-ST	2989349	407	FOC-LC-A-LC-A-GZ01/1	1409787	417	FOC-SJA-A-SJA-GZ02/...	1405704	418	G-INB-M16-S68N-PNES-GY	1411124	686
FL SM PATCH 2,0 SC-SC	2901830	407	FOC-LC-A-LC-A-GZ01/2	1400604	417	FOC-SJA-A-SJA-GZ02/1	1409814	418	G-INB-M16-S68N-PNES-LG	1417653	686
FL SM PATCH 2,0 SC-ST	2901833	407	FOC-LC-A-LC-A-GZ02/1	1409788	419	FOC-SJA-A-SJA-GZ02/2	1400699	418	G-INB-M16-T68N-NNES-S	1424526	688
FL SM PATCH 2,0 ST-ST	2901837	407	FOC-LC-A-LC-A-GZ02/2	1400621	419	FOC-SJA-A-SJA-GZ03/...	1405705	420	G-INB-M16-T68N-PNES-BK	1424480	686
FL SM PATCH 5,0 LC-LC	2901826	406	FOC-LC-A-LC-A-GZ03/...	1405690	421	FOC-SJA-A-SJA-GZ03/1	1409815	420	G-INB-M16-T68N-PNES-GY	1424475	686
FL SM PATCH 5,0 LC-SC	2901827	407	FOC-LC-A-LC-A-GZ03/1	1409789	421	FOC-SJA-A-SJA-GZ03/2	1400700	420	G-INB-M16-T68N-PNES-LG	1424470	686
FL SM PATCH 5,0 LC-ST	2901828	407	FOC-LC-A-LC-A-GZ03/2	1400622	421	FOC-ST-A-LC-A-GZ01/...	1405706	417	G-INB-M20-M68N-PNES-BK	1424481	686
FL SM PATCH 5,0 SC-SC	2901831	407	FOC-LC-A-LC-A-GZ04/...	1413788	415	FOC-ST-A-LC-A-GZ01/1	1409816	417	G-INB-M20-M68N-PNES-GY	1424476	686
FL SM PATCH 5,0 SC-ST	2901834	407	FOC-LC-A-LC-A-GZ04/1	1413826	415	FOC-ST-A-LC-A-GZ01/2	1400701	417	G-INB-M20-M68N-PNES-LG	1424471	686
FL SM PATCH 5,0 ST-ST	2901838	407	FOC-LC-A-SJA-GZ01/...	1405694	417	FOC-ST-A-LC-A-GZ02/...	1405707	419	G-INB-M20-M68N-SNES-S	1424543	692
FL SM PATCH COUPLER LC-LC	2700313	380	FOC-LC-A-SJA-GZ01/1	1409793	417	FOC-ST-A-LC-A-GZ02/1	1409818	419	G-INB-M20-S68N-NNES-S	1411163	688
FLX ASI 3.0 DIO 4/4 M12-2A	2773474	443	FOC-LC-A-SJA-GZ01/2	1400682	417	FOC-ST-A-LC-A-GZ02/2	1400702	419	G-INB-M20-S68N-PNES-BK	1411133	686
FLX ASI DI 4 M12	2773429	442	FOC-LC-A-SJA-GZ02/...	1405695	419	FOC-ST-A-LC-A-GZ04/...	1413792	415	G-INB-M20-S68N-PNES-GY	1411125	686
FLX ASI DI 4 M8	2773403	441	FOC-LC-A-SJA-GZ02/1	1409796	419	FOC-ST-A-LC-A-GZ04/1	1413831	415	G-INB-M20-S68N-PNES-LG	1414568	686
FLX ASI DIO 2/2 M12-2A	2773432	443	FOC-LC-A-SJA-GZ02/2	1400683	419	FOC-ST-A-SC-A-GZ01/...	1405708	417	G-INB-M25-L68N-PNES-BK	1424482	686
FLX ASI DIO 4/3 M12-2A	2773445	443	FOC-LC-A-SJA-GZ03/...	1405696	421	FOC-ST-A-SC-A-GZ01/1	1409819	417	G-INB-M25-L68N-PNES-GY	1424477	686
FLX ASI DIO 4/4 M8-1A	2773416	441	FOC-LC-A-SJA-GZ03/1	1409797	421	FOC-ST-A-SC-A-GZ01/2	1400703	417	G-INB-M25-L68N-PNES-LG	1424472	686
FLX ASI DO 4 M12-2A	2773458	442	FOC-LC-A-SJA-GZ03/2	1400684	421	FOC-ST-A-SC-A-GZ02/...	1405709	419	G-INB-M25-M68N-NNES-S	1411165	688
FOC-C-LC:P-GOF-MM/10	1411294	378	FOC-MODUL3U-OS12-LCD6-OM1	1419978	390	FOC-ST-A-SC-A-GZ02/1	1409821	419	G-INB-M25-S68N-PNES-BK	1411134	686
FOC-C-LC:P-GOF-SM-APC	1412476	378	FOC-OE-OE-GB01/...	1406429	408	FOC-ST-A-SC-A-GZ02/2	1400705	419	G-INB-M25-M68N-PNES-GY	1411126	686
FOC-C-LC:P-GOF-SM-PC	1411295	378	FOC-OE-OE-GB02/...	1406430	408	FOC-ST-A-SJA-GZ01/...	1405710	417	G-INB-M25-M68N-PNES-LG	1417654	686
FOC-C-LCDU-GOF-MM	1411052	378	FOC-OE-OE-GB03/...	1406431	408	FOC-ST-A-SJA-GZ01/1	1409822	417	G-INB-M25-M68N-SNES-S	1424544	692
FOC-C-LCDU-GOF-MM/10	1411298	378	FOC-OE-OE-GZ01/...	1411561	416	FOC-ST-A-SJA-GZ01/2	1400706	417	G-INB-M25-S68N-NNES-S	1424527	688
FOC-C-LCDU-GOF-SM-APC	1412472	378	FOC-OE-OE-GZ02/...	1411563	418	FOC-ST-A-SJA-GZ02/...	1405711	419	G-INB-M32-L68N-PNES-BK	1424483	686
FOC-C-LCDU-GOF-SM-APC/10	1412479	378	FOC-OE-OE-GZ03/...	1411564	420	FOC-ST-A-SJA-GZ02/1	1409823	419	G-INB-M32-L68N-PNES-GY	1424478	686
FOC-C-LCDU-GOF-SM-PC	1411053	378	FOC-OE-OE-GZ04/...	1411566	414	FOC-ST-A-SJA-GZ02/2	1400711	419	G-INB-M32-L68N-PNES-LG	1424473	

Type	Order No.	Page	Type	Order No.	Page	Type	Order No.	Page	Type	Order No.	Page
G-INS-M40-L68N-PNES-GY	1424479	686	G-INVEN-M12-M67N-PNES-BK	1424535	694	HC-ADV-B10-HHWH-1TTM25-MF-BK	1420908	603	HC-B 10-A-DT-PEL-M	1648403	549
G-INS-M40-L68N-PNES-LG	1424474	686	G-INVEN-M12-M67N-PNES-LG	1424532	694	HC-ADV-B10-HHWH-1TTM32-EMC-AL	1413402	603	HC-B 10-A-DT-PER-F	1648416	549
G-INS-M40-M68N-PNES-S	1411167	688	G-INVEN-M16-M67N-PNES-S	1424539	694	HC-ADV-B10-HHWH-1TTM32-MF-BK	1420909	603	HC-B 10-A-DT-PER-M	1648429	549
G-INS-M40-M68N-PNES-BK	1411137	686	G-INVEN-M16-M67N-PNES-BK	1424536	694	HC-ADV-B10-HHWH-BLANK-ELC-AL	1420052	603	HC-B 10-A-UT-PEL-F	1648030	551
G-INS-M40-M68N-PNES-GY	1411128	686	G-INVEN-M16-M67N-PNES-LG	1424533	694	HC-ADV-B10-HLWH-1STM20-EMC-AL	1413389	603	HC-B 10-A-UT-PEL-M	1648036	551
G-INS-M40-M68N-PNES-LG	1417656	686	G-INVEN-M20-M67N-PNES-S	1424540	694	HC-ADV-B10-HLWH-1STM20-MF-BK	1420910	603	HC-B 10-A-UT-PER-F	1648078	551
G-INS-M40-M68N-PNES-S	1424546	692	G-INVEN-M20-M67N-PNES-BK	1424537	694	HC-ADV-B10-HLWH-1STM25-EMC-AL	1413391	603	HC-B 10-A-UT-PER-M	1648084	551
G-INS-M40-S68N-PNES-S	1424529	688	G-INVEN-M20-M67N-PNES-LG	1424534	694	HC-ADV-B10-HLWH-1STM25-MF-BK	1420911	603	HC-B 10-ADP/1 DSUB 25	1775499	665
G-INS-M50-L68L-PNES-BK	1411138	686	GPE 13X 9 WH	0806932	480	HC-ADV-B10-HLWH-1TTM20-EMC-AL	1413388	603	HC-B 10-ADP/2 DSUB 25	1775509	665
G-INS-M50-L68L-PNES-GY	1411129	686				HC-ADV-B10-HLWH-1TTM20-MF-BK	1420912	603	HC-B 10-ANDOCK	1586125	663
G-INS-M50-L68L-PNES-LG	1417657	686				HC-ADV-B10-HLWH-1TTM25-EMC-AL	1413390	603	HC-B 10-AP-GY	1660371	664
G-INS-M50-L68N-PNES-S	1411168	688				HC-ADV-B10-HLWH-1TTM25-MF-BK	1420913	603	HC-B 10-EBUQ-2,5	1605569	543
G-INS-M50-M68N-PNES-S	1424530	688				HC-ADV-B10-HLWH-BLANK-ELC-AL	1420051	603	HC-B 10-ESTQ-2,5	1605624	543
G-INS-M63-E68N-PNES-S	1424531	688				HC-ADV-B16-HHWH-1TGM32-PL	1404232	616	HC-B 10-I-CTF	1648225	543
G-INS-M63-L68L-PNES-BK	1411139	686				HC-ADV-B16-HHWH-1SGM40-PL	1404234	616	HC-B 10-I-CTM	1648212	543
G-INS-M63-L68L-PNES-GY	1411130	686				HC-ADV-B16-HHWH-1STM25-EMC-AL	1414978	617	HC-B 10-I-UTF	1648186	543
G-INS-M63-L68L-PNES-LG	1417658	686				HC-ADV-B16-HHWH-1STM25-MF-BK	1420914	617	HC-B 10-I-UTM	1648173	543
G-INS-M63-L68N-PNES-S	1411169	688				HC-ADV-B16-HHWH-1TTM32-EMC-AL	1413417	617	HC-B 10-SD-FLU/FS-AL	1644562	655
G-INS-PG11-M68N-PNES-BK	1424497	687				HC-ADV-B16-HHWH-1STM32-MF-BK	1420915	617	HC-B 10-SD-FQT/FS-AL	1647750	654
G-INS-PG11-M68N-PNES-LG	1424487	687				HC-ADV-B16-HHWH-1STM40-EMC-AL	1413419	617	HC-B 10-SD-FQU/FS-AL	1644575	655
G-INS-PG11-S68N-PNES-S	1411172	689				HC-ADV-B16-HHWH-1STM40-MF-BK	1420916	617	HC-B 10-SD-MLT/FS-AL	1584512	654
G-INS-PG11-S68N-PNES-GY	1411168	687				HC-ADV-B16-HHWH-1TGM32-PL	1404231	616	HC-B 10-SD-MQT/FS-AL	1584541	654
G-INS-PG13,5-M68N-PNES-BK	1424498	687				HC-ADV-B16-HHWH-1TGM40-PL	1404233	616	HC-B 10-TMS-SD-IP50	1690749	602
G-INS-PG13,5-M68N-PNES-LG	1424488	687				HC-ADV-B16-HHWH-1TTM25-EMC-AL	1414977	617	HC-B 10-TMS-SD-IP66	1411504	602
G-INS-PG13,5-S68N-PNES-S	1411173	689				HC-ADV-B16-HHWH-1TTM25-MF-BK	1420917	617	HC-B 16-A-DT-PEL-F	1648432	549
G-INS-PG13,5-S68N-PNES-GY	1411143	687				HC-ADV-B16-HHWH-1TTM32-EMC-AL	1413416	617	HC-B 16-A-DT-PEL-M	1648445	549
G-INS-PG16-M68N-PNES-BK	1424499	687				HC-ADV-B16-HHWH-1TTM32-MF-BK	1420918	617	HC-B 16-A-DT-PER-F	1648458	549
G-INS-PG16-M68N-PNES-LG	1424489	687				HC-ADV-B16-HHWH-1TTM40-EMC-AL	1413418	617	HC-B 16-A-DT-PER-M	1648461	549
G-INS-PG16-S68N-PNES-S	1411174	689				HC-ADV-B16-HHWH-1TTM40-MF-BK	1420919	617	HC-B 16-A-UT-PEL-F	1648042	551
G-INS-PG16-S68N-PNES-GY	1411144	687				HC-ADV-B16-HHWH-BLANK-ELC-AL	1420054	617	HC-B 16-A-UT-PEL-M	1648048	551
G-INS-PG21-M68N-PNES-S	1411175	689				HC-ADV-B16-HLWH-1STM25-EMC-AL	1414976	617	HC-B 16-A-UT-PER-F	1648090	551
G-INS-PG21-M68N-PNES-BK	1424500	687				HC-ADV-B16-HLWH-1STM25-MF-BK	1420920	617	HC-B 16-A-UT-PER-M	1648096	551
G-INS-PG21-M68N-PNES-GY	1411145	687				HC-ADV-B16-HLWH-1TTM25-EMC-AL	1414975	617	HC-B 16-ADP/1 DSUB 37	1775512	665
G-INS-PG21-M68N-PNES-LG	1424490	687				HC-ADV-B16-HLWH-1TTM25-MF-BK	1420921	617	HC-B 16-ADP/1 DSUB 50	1775538	665
G-INS-PG29-M68N-PNES-S	1411176	689				HC-ADV-B16-HLWH-BLANK-ELC-AL	1420053	617	HC-B 16-ADP/2 DSUB 37	1775525	665
G-INS-PG29-M68N-PNES-BK	1424501	687				HC-ADV-B24-HHWH-1SGM32-PL	1404237	630	HC-B 16-ADP/2 DSUB 50	1775541	665
G-INS-PG29-M68N-PNES-LG	1411146	687				HC-ADV-B24-HHWH-1SGM40-PL	1404239	630	HC-B 16-ANDOCK	1586138	663
G-INS-PG29-M68N-PNES-S	1424491	687				HC-ADV-B24-HHWH-1STM25-EMC-AL	1414981	631	HC-B 16-AP-GY	1660384	664
G-INS-PG36-L68N-PNES-S	1411178	689				HC-ADV-B24-HHWH-1STM25-MF-BK	1420922	631	HC-B 16-APV-GY	1661121	664
G-INS-PG36-L68N-PNES-GY	1411147	687				HC-ADV-B24-HHWH-1TTM32-EMC-AL	1413431	631	HC-B 16-EBUQ-2,5	1605572	545
G-INS-PG36-M68N-PNES-BK	1424502	687				HC-ADV-B24-HHWH-1STM32-MF-BK	1420923	631	HC-B 16-EBUQ-2,5-32	1605598	545
G-INS-PG36-M68N-PNES-LG	1424492	687				HC-ADV-B24-HHWH-1STM40-EMC-AL	1413433	631	HC-B 16-ESTQ-2,5	1605637	545
G-INS-PG42-L68N-PNES-S	1411179	689				HC-ADV-B24-HHWH-1TTM25-MF-BK	1420924	631	HC-B 16-ESTQ-2,5-32	1605653	545
G-INS-PG42-L68N-PNES-GY	1411149	687				HC-ADV-B24-HHWH-1TGM32-PL	1404235	630	HC-B 16-I-CTF	1648283	545
G-INS-PG42-M68N-PNES-BK	1424503	687				HC-ADV-B24-HHWH-1TGM40-PL	1404238	630	HC-B 16-I-CTF-32	1584923	545
G-INS-PG42-M68N-PNES-LG	1424493	687				HC-ADV-B24-HHWH-1TTM25-EMC-AL	1414980	631	HC-B 16-I-CTM	1648270	545
G-INS-PG48-L68N-PNES-S	1411181	689				HC-ADV-B24-HHWH-1TTM40-MF-BK	1420925	631	HC-B 16-I-CTM-32	1584910	545
G-INS-PG48-L68N-PNES-GY	1411150	687				HC-ADV-B24-HHWH-1TTM32-EMC-AL	1413430	631	HC-B 16-I-UTF	1648241	545
G-INS-PG48-M68N-PNES-BK	1424504	687				HC-ADV-B24-HHWH-1TTM32-MF-BK	1420926	631	HC-B 16-I-UTF-32	1584884	545
G-INS-PG48-M68N-PNES-LG	1424494	687				HC-ADV-B24-HHWH-1TTM40-EMC-AL	1413432	631	HC-B 16-I-UTM	1648238	545
G-INS-PG7-M68N-PNES-BK	1424495	687				HC-ADV-B24-HHWH-1TTM40-MF-BK	1420927	631	HC-B 16-I-UTM-32	1584871	545
G-INS-PG7-M68N-PNES-LG	1424485	687				HC-ADV-B24-HHWH-BLANK-ELC-AL	1420056	617	HC-B 16-SD-FLU/FS-AL	1644588	655
G-INS-PG7-S68N-PNES-S	1411170	689				HC-ADV-B24-HLWH-1STM25-EMC-AL	1414983	631	HC-B 16-SD-FQT/FS-AL	1647763	654
G-INS-PG7-S68N-PNES-GY	1411140	687				HC-ADV-B24-HLWH-1STM25-MF-BK	1420928	631	HC-B 16-SD-FQU/FS-AL	1644591	655
G-INS-PG9-M68N-PNES-BK	1424496	687				HC-ADV-B24-HLWH-1TTM25-EMC-AL	1414982	631	HC-B 16-SD-MLT/FS-AL	1584525	664
G-INS-PG9-M68N-PNES-LG	1424486	687				HC-ADV-B24-HLWH-1TTM25-MF-BK	1420929	631	HC-B 16-SD-MQT/FS-AL	1584554	654
G-INS-PG9-S68N-PNES-S	1411171	689				HC-ADV-B24-HLWH-BLANK-ELC-AL	1420055	631	HC-B 16-TMS-SD-IP50	1690752	616
G-INS-PG9-S68N-PNES-GY	1411141	687				HC-B 6-A-DT-PEL-F	1648351	549	HC-B 16-TMS-SD-IP66	1411517	655
G-INSEC-M12-S68N-NCRS-S	1411187	690				HC-B 6-A-DT-PEL-M	1648364	549	HC-B 24-A-DT-PEL-F	1648474	549
G-INSEC-M16-S68L-NCRS-S	1077099	690				HC-B 6-A-DT-PER-F	1648377	549	HC-B 24-A-DT-PEL-M	1648487	549
G-INSEC-M20-S68N-NCRS-S	1411189	690				HC-B 6-A-DT-PER-M	1648380	549	HC-B 24-A-DT-PER-F	1648490	549
G-INSEC-M23-S68N-NCRS-S	1411190	690				HC-B 6-A-UT-PEL-F	1648018	551	HC-B 24-A-DT-PER-M	1648500	549
G-INSEC-M32-M68N-NCRS-S	1411191	690				HC-B 6-A-UT-PEL-M	1648024	551	HC-B 24-A-UT-PEL-F	1648054	551
G-INSEC-M40-M68N-NCRS-S	1411192	690				HC-B 6-A-UT-PER-F	1648066	551	HC-B 24-A-UT-PEL-M	1648060	551
G-INSEC-M50-L68N-NCRS-S	1411193	690				HC-B 6-A-UT-PER-M	1648072	551	HC-B 24-A-UT-PER-F	1648102	551
G-INSEC-M63-L68N-NCRS-S	1411194	690				HC-B 6-ADP/1 DSUB 9	1775457	665	HC-B 24-ADP-GY	1648108	551
G-INSEC-PG11-S68N-PNES-S	1411197	691				HC-B 6-ADP/1 DSUB 15	1775473	665	HC-B 24-ADP-3D 7-GY	1661448	664
G-INSEC-PG13,5-S68N-PNES-S	1411198	691				HC-B 6-ADP/2 DSUB 9	1775460	665	HC-B 24-ADP-3RST-GY	1662175	664
G-INSEC-PG16-S68N-PNES-S	1411199	691				HC-B 6-ADP/2 DSUB 15	1775486	665	HC-B 24-ANDOCK	1586141	663
G-INSEC-PG21-M68N-PNES-S	1411200	691				HC-B 6-ANDOCK	1586112	663	HC-B 24-AP-GY	1660397	664
G-INSEC-PG29-M68N-PNES-S	1411201	691				HC-B 6-AP-GY	1660368	664	HC-B 24-APV-GY	1661037	664
G-INSEC-PG36-L68N-PNES-S	1411202	691				HC-B 6-EBUQ-2,5	1605556	541	HC-B 24-EBUQ-2,5	1605585	547
G-INSEC-PG42-L68N-PNES-S	1411203	691				HC-B 6-ESTQ-2,5	1605611	541	HC-B 24-EBUQ-2,5-48	1605608	547
G-INSEC-PG48-L68N-PNES-S	1411204	691				HC-B 6-I-CTF	1648160	541	HC-B 24-ESTQ-2,5	1605640	547
G-INSEC-PG7-S68N-PNES-S	1411195	691				HC-B 6-I-CTM	1648157	541	HC-B 24-ESTQ-2,5-48	1605666	547
G-INSEC-PG9-S68N-PNES-S	1411196	691				HC-B 6-SD-FLU/FS-AL	1644559	655	HC-B 24-I-CTF	1648348	547
G-INTRO-M20-S68N-PEPDS-BK	1415189	698				HC-B 6-SD-MLT/FS-AL	1644546	654	HC-B 24-I-CTF-48	1584981	547
G-INTRO-M25-M68N-PEPDS-BK	1415190	698				HC-B 6-TMS-SD-IP50	1690736	596	HC-B 24-I-CTM	1648335	547
G-INTRO-M32-M68N-PEPDS-BK	1415191	698				HC-B 6-TMS-SD-IP66	1411494	596	HC-B 24-I-CTM-48	1584978	547
G-INVEN-M12-M67N-PNES-S	1424538	694				HC-B 10-A-DT-PEL-F	1648393	549	HC-B 24-I-UTF	1648306	547

Index

Alphabetical

Type	Order No.	Page	Type	Order No.	Page	Type	Order No.	Page	Type	Order No.	Page
HC-B 24-I-UT-F-48	1584949	547	HC-B10-I-PT-F	1407729	543	HC-CIF-B24-HFWL-PL	1424337	684	HC-EVO-A16PT-BWSC-HH-M25-PLRKB	1424460	528
HC-B 24-I-UT-M	1648296	547	HC-B10-I-PT-M	1407730	543	HC-CIF-D15-AIWS-SM-NI	1424340	684	HC-EVO-A16UT-BWS-HH-M25-PLRKB	1411358	528
HC-B 24-I-UT-M-48	1584936	547	HC-B10-I-TPT-F	1423018	543	HC-CIF-D25-AIWS-SM-NI	1424341	684	HC-EVO-A16UT-BWSC-HH-M25-PLRKB	1411359	528
HC-B 24-SD-FLU/FS-AL	1644601	655	HC-B10-I-TPT-M	1423017	543	HC-COM-BAWS-EL-AL	1078593	653	HC-EVO-B06-BWS-PLRKB	1407621	598
HC-B 24-SD-FQT/FS-AL	1647776	654	HC-B16-BCSFD-P-BK	1414629	655	HC-COM-BAWS-PL-BK	1012433	652	HC-EVO-B06-BWSC-PLRKB	1407622	598
HC-B 24-SD-FQU/FS-AL	1644614	655	HC-B16-BCSFS-P-BK	1414626	655	HC-COM-BWS-EL-AL	1078594	653	HC-EVO-B06-CHWS-PLRKB	1407625	598
HC-B 24-SD-MLT/FS-AL	1584538	654	HC-B16-HCLFD-PR-BK	1414632	654	HC-COM-BWS-PL-BK	1012538	652	HC-EVO-B06-HHFS-2B-PL-BK	1420930	598
HC-B 24-SD-MQT/FS-AL	1584567	654	HC-B16-HCLWD-PLR-BK	1414639	654	HC-COM-CHWS-1TGM25-PL-BK	1012521	652	HC-EVO-B06-HHFS-EL-AL	1411447	599
HC-B 24-TMS-SD-IP50	1690765	630	HC-B16-HCLWS-PLR-BK	1414636	654	HC-COM-CHWS-1TTM25-EL-AL	1078595	653	HC-EVO-B06-HHFS-PLBK	1407620	598
HC-B 24-TMS-SD-IP66	1411520	630	HC-B16-I-PT-F	1407731	545	HC-COM-HHFS-1SGM25-PL-BK	1012581	652	HC-EVO-B06-HLFS-EL-AL	1411448	599
HC-B 48-LB-ERSBOLZ	1636114	663	HC-B16-I-PT-F-32	1407733	545	HC-COM-HHFS-1STM25-EL-AL	1078592	653	HC-EVO-B06-HLFS-PLBK	1407619	598
HC-B 6-I-UT-F	1648128	541	HC-B16-I-PT-M	1407732	545	HC-COM-HHFS-1TGM25-PL-BK	1012520	652	HC-EVO-B06-SHWS-2SSM20-PLRKB	1421322	598
HC-B 6-I-UT-M	1648115	541	HC-B16-I-PT-M-32	1407734	545	HC-COM-HHFS-1TTM25-EL-AL	1078590	653	HC-EVO-B06-SHWS-2SSM25-PLRKB	1421229	598
HC-B 3PE	1644326	662	HC-B16-I-TPT-F	1423020	545	HC-COM-SHOWS-1SGM25-PL-BK	1079393	652	HC-EVO-B06-SHWS-2SSM32-PLRKB	1407623	598
HC-B-AF	1686533	596	HC-B16-I-TPT-F-32	1423826	545	HC-COM-SHOWS-1STM25-EL-AL	1078596	653	HC-EVO-B06-SHWSC-2SSM20-PLRKB	1421329	598
HC-B-AF-SET	1604638	596	HC-B16-I-TPT-M	1423019	545	HC-CST-MOD	1636127	657	HC-EVO-B06-SHWSC-2SSM25-PLRKB	1421244	598
HC-B-G-M20-EC-AL	1411439	605	HC-B16-I-TPT-M-32	1423825	545	HC-D 4-1BU	1886143	669	HC-EVO-B06-SHWSC-2SSM32-PLRKB	1407624	598
HC-B-G-M20-PLRKB	1407669	604	HC-B24-BCSFD-P-BK	1414630	655	HC-D 4-1ST	1886144	669	HC-EVO-B06-PT-BWSC-HL-M20-PLRKB	1407710	646
HC-B-G-M25-EC-AL	1411446	605	HC-B24-BCSFS-P-BK	1414627	655	HC-D 4-2BU	1886140	669	HC-EVO-B10-BFDC-PLRKB	1407635	612
HC-B-G-M25-PLRKB	1407670	604	HC-B24-HCLFD-PR-BK	1414633	654	HC-D 4-2ST	1886141	669	HC-EVO-B10-BWD-PLRKB	1407634	608
HC-B-G-M32-EC-AL	1411440	605	HC-B24-HCLWD-PLR-BK	1414640	654	HC-D 4-BU-2BUS	1886139	669	HC-EVO-B10-BWS-PLRKB	1407632	604
HC-B-G-M32-PLRKB	1407671	604	HC-B24-HCLWS-PLR-BK	1414637	654	HC-D 4-1ST	1886142	669	HC-EVO-B10-BWSC-PLRKB	1407633	604
HC-B-G-M40-EC-AL	1411441	605	HC-B24-I-PT-F	1407735	547	HC-D 7-DS-IP65	1686229	663	HC-EVO-B10-CHWD-PLRKB	1407641	608
HC-B-G-M40-PLRKB	1407672	604	HC-B24-I-PT-F-48	1407737	547	HC-D 7-I-CT-F	1584347	507	HC-EVO-B10-CHWS-PLRKB	1407640	604
HC-B-GB-M20-ER-AL	1414663	660	HC-B24-I-PT-M	1407736	547	HC-D 7-I-CT-M	1584334	507	HC-EVO-B10-HHFD-2B-PL-BK	1411495	608
HC-B-GB-M20-PLRKB	1414660	659	HC-B24-I-TPT-F	1407738	547	HC-D 8-I-CT-F	1584363	507	HC-EVO-B10-HHFD-EL-AL	1411451	609
HC-B-GB-M25-ER-AL	1414664	660	HC-B24-I-TPT-F-32	1423022	547	HC-D 8-I-CT-M	1584350	507	HC-EVO-B10-HHFD-PLBK	1407629	608
HC-B-GB-M25-PLRKB	1414661	659	HC-B24-I-TPT-F-48	1423828	547	HC-D 15-ADP/1 DSUB 9	1661312	665	HC-EVO-B10-HHFS-EL-AL	1411453	605
HC-B-GB-M32-ER-AL	1414665	660	HC-B24-I-TPT-M	1423021	547	HC-D 15-ADP/1 DSUB 15	1775253	665	HC-EVO-B10-HHFS-PLBK	1407627	604
HC-B-GB-M32-PLRKB	1414662	659	HC-B24-I-TPT-M-48	1423827	547	HC-D 15-ADP/1 DSUB 25	1775266	665	HC-EVO-B10-HHWD-EL-AL	1411454	613
HC-B-GB-M40-ER-AL	1414666	660	HC-BB 10-I-PT-F	1014417	553	HC-D 15-AP-GY	1660342	664	HC-EVO-B10-HHWD-PLBK	1407631	612
HC-B-GM0-M40-ET-AL	1414647	660	HC-BB 10-I-PT-M	1014418	553	HC-D 15-I-CT-F	1584389	523	HC-EVO-B10-HLFD-EL-AL	1411455	609
HC-B-GM0-M40-PLTBK	1414643	658	HC-BB 18-I-PT-F	1014419	553	HC-D 15-I-CT-M	1584376	523	HC-EVO-B10-HLFD-PLBK	1407628	608
HC-B-GM4X10-M40-ET-AL	1414648	660	HC-BB 18-I-PT-M	1014420	553	HC-D 25-AP-GY	1660355	664	HC-EVO-B10-HLFS-EL-AL	1411456	605
HC-B-GM4X10-M40-PLTBK	1414644	658	HC-BB 32-I-PT-F	1014421	553	HC-D 25-I-CT-F	1584402	523	HC-EVO-B10-HLFS-PLBK	1407626	604
HC-B-GM5X8,5-M40-ET-AL	1414649	660	HC-BB 32-I-PT-M	1014422	553	HC-D 25-I-CT-F-Z	1411481	523	HC-EVO-B10-HLWD-EL-AL	1411457	613
HC-B-GM5X8,5-M40-PLTBK	1414645	658	HC-BB 46-I-PT-F	1014423	553	HC-D 25-I-CT-M	1584392	523	HC-EVO-B10-HLWD-PLBK	1407630	612
HC-B-GM8X6,5-M40-ET-AL	1414650	660	HC-BB 46-I-PT-M	1014424	553	HC-D 25-I-CTM-Z	1411478	523	HC-EVO-B10-SHFDC-2SSM20-PLRKB	1421362	612
HC-B-GM8X6,5-M40-PLTBK	1414646	658	HC-BB10-I-CT-F	1584703	555	HC-D 40-A-TWIN-PEL-F	1580147	537	HC-EVO-B10-SHFDC-2SSM25-PLRKB	1421320	612
HC-B-GTRS-M20-ER-AL	1414656	660	HC-BB10-I-CT-M	1584774	555	HC-D 40-A-TWIN-PEL-M	1580150	537	HC-EVO-B10-SHFDC-2SSM32-PLRKB	1407639	612
HC-B-GTRS-M20-PLRKB	1414651	659	HC-BB18-I-CT-F	1584729	555	HC-D 40-A-TWIN-PER-F	1580163	537	HC-EVO-B10-SHWD-2SSM20-PLRKB	1421356	608
HC-B-GTRS-M25-ER-AL	1414657	660	HC-BB18-I-CT-M	1584716	555	HC-D 40-A-TWIN-PER-M	1580176	537	HC-EVO-B10-SHWD-2SSM25-PLRKB	1421304	608
HC-B-GTRS-M25-PLRKB	1414652	659	HC-BB32-I-CT-F	1584745	555	HC-D 40-A-UT-PEL-F	1584253	537	HC-EVO-B10-SHWD-2SSM32-PLRKB	1407638	608
HC-B-GTRS-M32-ER-AL	1414658	660	HC-BB32-I-CT-F 33-64	1406543	555	HC-D 40-A-UT-PEL-M	1584240	537	HC-EVO-B10-SHWS-2SSM20-PLRKB	1421354	604
HC-B-GTRS-M32-PLRKB	1414654	659	HC-BB32-I-CT-M	1584732	555	HC-D 40-A-UT-PER-F	1584279	537	HC-EVO-B10-SHWS-2SSM25-PLRKB	1421277	604
HC-B-GTRS-M40-ER-AL	1414659	660	HC-BB32-I-CT-M 33-64	1406544	555	HC-D 40-A-UT-PER-M	1584266	537	HC-EVO-B10-SHWS-2SSM32-PLRKB	1407636	604
HC-B-PES	1604997	662	HC-BB46-I-CT-F	1584758	555	HC-D 40-A-UT-PER-F	1584428	535	HC-EVO-B10-SHWSC-2SSM20-PLRKB	1421355	604
HC-B-SG-PL-BK	1424343	684	HC-BB46-I-CT-F 47-92	1406545	555	HC-D 40-I-CT-M	1584415	535	HC-EVO-B10-SHWSC-2SSM25-PLRKB	1421301	604
HC-B-TA-M20-ER-AL	1414256	661	HC-BB46-I-CT-M	1584761	555	HC-D 64-A-TWIN-PEL-F	1580189	537	HC-EVO-B10-SHWSC-2SSM32-PLRKB	1407637	604
HC-B-TA-M20-PLR-BK	1414243	659	HC-BB46-I-CT-M 47-92	1406546	555	HC-D 64-A-TWIN-PEL-M	1580192	537	HC-EVO-B10-PT-BWD-HL-M25-PLRKB	1407711	646
HC-B-TA-M25-ER-AL	1414257	661	HC-BBB 40-EBUC	1409930	557	HC-D 64-A-TWIN-PER-F	1580202	537	HC-EVO-B10-PT-BWSC-HL-M25-PLRKB	1408791	646
HC-B-TA-M25-PLR-BK	1414244	659	HC-BBB 40-ESTC	1409921	557	HC-D 64-A-TWIN-PER-M	1580215	537	HC-EVO-B16-BFDC-PLRKB	1407649	626
HC-B-TA-M32-ER-AL	1414258	661	HC-BBB 64-EBUC	1409914	557	HC-D 64-A-UT-PEL-F	1584295	537	HC-EVO-B16-BWD-PLRKB	1407648	622
HC-B-TA-M32-PLR-BK	1414245	659	HC-BBB 64-ESTC	1409901	557	HC-D 64-A-UT-PEL-M	1584282	537	HC-EVO-B16-BWS-PLRKB	1407646	618
HC-B-TA-M40-ER-AL	1414259	661	HC-BS-PG11	1674493	703	HC-D 64-A-UT-PER-F	1584321	537	HC-EVO-B16-BWSC-PLRKB	1407647	618
HC-B-TA-M40-PLR-BK	1414246	659	HC-BS-PG13	1674503	703	HC-D 64-A-UT-PER-M	1584318	537	HC-EVO-B16-CHWD-PLRKB	1407655	622
HC-B-TA-NPT-1/4-ER-AL	1414267	661	HC-BS-PG16	1674516	703	HC-D 64-I-CT-F	1584444	535	HC-EVO-B16-CHWS-PLRKB	1407654	618
HC-B-TA-NPT-1/1-ER-AL	1414266	661	HC-BS-PG21	1674529	703	HC-D 64-I-CT-M	1584431	535	HC-EVO-B16-HHFD-2B-PL-BK	1411496	622
HC-B-TA-NPT-1/2-ER-AL	1414264	661	HC-BS-PG29	1674532	703	HC-D 64-I-CT-M-PLRKB	1411350	524	HC-EVO-B16-HHFD-EL-AL	1411460	623
HC-B-TA-NPT-3/4-ER-AL	1414265	661	HC-BS-PG36	1674545	703	HC-D G-M25-PLRKB	1411351	524	HC-EVO-B16-HHFD-PLBK	1407643	622
HC-B-TA-PG13-ER-AL	1414260	661	HC-BS-PG7	1046670	703	HC-D-TA-M25-PLRKB	1411352	595	HC-EVO-B16-HHFS-EL-AL	1411461	619
HC-B-TA-PG13-PLR-BK	1414247	659	HC-BS-PG9	1046669	703	HC-D-TA-NPT-3/4-PLR-BK	1411354	595	HC-EVO-B16-HHFS-PLBK	1407642	618
HC-B-TA-PG16-ER-AL	1414261	661	HC-CB	1772722	656	HC-D-TA-PG16-PLR-BK	1411353	595	HC-EVO-B16-HHWD-EL-AL	1411462	627
HC-B-TA-PG16-PLR-BK	1414248	659	HC-CBU-MOD	1636130	657	HC-DD108-I-CT-F	1584130	539	HC-EVO-B16-HHWD-PLBK	1407644	626
HC-B-TA-PG21-ER-AL	1414262	661	HC-CIF-2B6-BFFD-FH-AL	1404214	685	HC-DD108-I-CT-F-216	1584143	539	HC-EVO-B16-HLFD-PLBK	1420932	622
HC-B-TA-PG21-PLR-BK	1414249	659	HC-CIF-2B6-HFFD-FH-AL	1404215	685	HC-DD108-I-CT-M	1584114	539	HC-EVO-B16-HLFS-PLBK	1420931	618
HC-B-TA-PG29-ER-AL	1414263	661	HC-CIF-B06-24-AEWL-PL-BK	1424342	684	HC-DD108-I-CT-M-216	1584127	539	HC-EVO-B16-HLWD-PLBK	1420933	626
HC-B-ZG	1685327	662	HC-CIF-B06-24-BFAFL-PL	1424338	684	HC-DD24-I-CT-F	1584046	539	HC-EVO-B16-SHFDC-2SSM25-PLRKB	1421458	626
HC-B-ZS	1685330	662	HC-CIF-B06-HFWL-PL	1424334	684	HC-DD24-I-CT-M	1584033	539	HC-EVO-B16-SHFDC-2SSM32-PLRKB	1421366	626
HC-B06-BCSFS-P-BK	1414623	655	HC-CIF-B10-BFFD-FH-AL	1404219	685	HC-DD24-I-CT-F	1584062	539	HC-EVO-B16-SHFDC-2SSM32-PLRKB	1407653	626
HC-B06-HCLWS-PLR-BK	1414634	654	HC-CIF-B10-BFWD-FH-AL	1404220	685	HC-DD42-I-CT-M	1584059	539	HC-EVO-B16-SHWD-2SSM25-PLRKB	1421455	622
HC-B06-I-PT-F	1407727	541	HC-CIF-B10-HFFD-WH-AL	1404221	685	HC-DD72-I-CT-F	1584091	539	HC-EVO-B16-SHWD-2SSM32-PLRKB	1421365	622
HC-B06-I-PT-M	1407728	541	HC-CIF-B10-HFWL-PL	1424335	684	HC-DD72-I-CT-F-144	1584101	539	HC-EVO-B16-SHWD-2SSM40-PLRKB	1407652	622
HC-B06-I-TPT-F	1423016	541									

Type	Order No.	Page	Type	Order No.	Page	Type	Order No.	Page	Type	Order No.	Page
HC-EVO-B16PT-BWSC-HH-M25-PLRBK	1408793	646	HC-K 6/12-ESTS	1636350	567	HC-M-BS-M12	1046636	702	HC-STA-B06-HHFS-1TTM32-EL-AL	1412567	600
HC-EVO-B24-BFDC-PLRBK	1407662	640	HC-K 6/36-EBUC	1636389	569	HC-M-BS-M16	1646227	702	HC-STA-B06-HHFS-1TTP21-EL-AL	1412568	600
HC-EVO-B24-BWD-PLRBK	1407661	636	HC-K 6/36-ESTC	1636376	569	HC-M-BS-M20	1645846	702	HC-STA-B06-HHFS-1TTP29-EL-AL	1412569	600
HC-EVO-B24-BWS-PLRBK	1407659	632	HC-K 8/24-EBUC	1636321	569	HC-M-BS-M25	1645859	702	HC-STA-B06-HHFS-BLANK-EL-AL	1419901	600
HC-EVO-B24-BWSC-PLRBK	1407660	632	HC-K 8/24-ESTC	1636318	569	HC-M-BS-M32	1645862	702	HC-STA-B06-HLFS-1STM20-EL-AL	1412570	600
HC-EVO-B24-CHWD-PLRBK	1407668	636	HC-K12/2-EBUC	1636347	569	HC-M-BS-M40	1645875	702	HC-STA-B06-HLFS-1STM25-EL-AL	1412571	600
HC-EVO-B24-CHWS-PLRBK	1407667	632	HC-K12/2-ESTC	1636334	569	HC-M-DSUB 09-CT-F	1417308	587	HC-STA-B06-HLFS-1STP13-EL-AL	1412572	600
HC-EVO-B24-HHFD-2B-PL-BK	1411497	636	HC-KA-FE	1775240	537	HC-M-DSUB 09-CT-M	1417309	587	HC-STA-B06-HLFS-1STP16-EL-AL	1412573	600
HC-EVO-B24-HHFD-EL-AL	1411472	637	HC-M-00	1414353	594	HC-M-DSUB 09-UT-F	1417307	587	HC-STA-B06-HLFS-1TTM20-EL-AL	1412574	600
HC-EVO-B24-HHFD-PLBK	1407657	636	HC-M-01-AT-F-40	1417379	573	HC-M-DSUB-09-UT-M	1423723	587	HC-STA-B06-HLFS-1TTM25-EL-AL	1412575	600
HC-EVO-B24-HHFS-EL-AL	1411473	633	HC-M-01-AT-F-40-PE	1417380	573	HC-M-DSUB-09-2/CT-F	1079793	587	HC-STA-B06-HLFS-1TTP13-EL-AL	1412576	600
HC-EVO-B24-HHFS-PLBK	1407656	632	HC-M-01-AT-M-40	1417381	573	HC-M-DSUB-09-2/CT-M	1079796	587	HC-STA-B06-HLFS-1TTP16-EL-AL	1412577	600
HC-EVO-B24-HHWD-EL-AL	1411474	641	HC-M-01-AT-M-40-PE	1417382	573	HC-M-EMV-BU/3-9,5	1636091	583	HC-STA-B06-HLFS-BLANK-EL-AL	1419900	600
HC-EVO-B24-HHWD-PLBK	1407658	640	HC-M-01-COAX-CK1,6-75-F	1066961	585	HC-M-EMV-ST/3-9,5	1636088	583	HC-STA-B06-SHWS-2SSM25-ELC-AL	1082556	599
HC-EVO-B24-HLFD-PLBK	1420935	636	HC-M-01-COAX-CK1,6-75-M	1066962	585	HC-M-KV-M20(1ASI)	1584017	438	HC-STA-B06-SHWS-2SSM32-ELC-AL	1082559	599
HC-EVO-B24-HLFS-PLBK	1420934	632	HC-M-01-COAX-CK2,5-50-F	1066959	585	HC-M-KV-M25(1ASI)	1584020	438	HC-STA-B06-SHWS-2SSM40-ELC-AL	1082566	599
HC-EVO-B24-HLWD-PLBK	1420936	640	HC-M-01-COAX-CK2,5-50-M	1066960	585	HC-M-KV-M25(1X10/1X11)	1580228	705	HC-STA-B06-SHWS-2SSM25-ELC-AL	1082575	599
HC-EVO-B24-SHFDC-2SSM25-PLRBK	1421462	640	HC-M-02-AT-F-10	1417387	573	HC-M-KV-T-M20	1646188	699	HC-STA-B06-SHWS-2SSM32-ELC-AL	1082576	599
HC-EVO-B24-SHFDC-2SSM32-PLRBK	1421380	640	HC-M-02-AT-F-16	1417296	573	HC-M-KV-T-M25	1646191	699	HC-STA-B06-SHWS-2SSM40-ELC-AL	1082577	599
HC-EVO-B24-SHFDC-2SSM40-PLRBK	1407666	640	HC-M-02-AT-F-35	1417390	573	HC-M-KV-T-M32	1646201	699	HC-STA-B06-SLWS-2SSM20-ELC-AL	1412821	599
HC-EVO-B24-SHWD-2SSM25-PLRBK	1421461	636	HC-M-02-AT-M-10	1417389	573	HC-M-KV-Z-M32	1646162	699	HC-STA-B06-SLWS-2SSM25-ELC-AL	1412822	599
HC-EVO-B24-SHWD-2SSM32-PLRBK	1421370	636	HC-M-02-AT-M-16	1417297	573	HC-M-KV-Z-M40	1646175	699	HC-STA-B06-SLWS-2SSM32-ELC-AL	1412823	599
HC-EVO-B24-SHWD-2SSM40-PLRBK	1407665	636	HC-M-02-AT-M-35	1417392	573	HC-M-MHR-PE16	1636981	573	HC-STA-B06-SLWSC-2SSM20-ELC-AL	1412825	599
HC-EVO-B24-SHWS-2SSM25-PLRBK	1421459	632	HC-M-02-CT-F	1414361	575	HC-M-PN2-6,00-BU	1676763	593	HC-STA-B06-SLWSC-2SSM25-ELC-AL	1412826	599
HC-EVO-B24-SHWS-2SSM32-PLRBK	1421367	632	HC-M-02-CT-F-HV-16	1417407	579	HC-M-PN2-6,00-BU-V	1676776	593	HC-STA-B06-SLWSC-2SSP16-ELC-AL	1412827	599
HC-EVO-B24-SHWS-2SSM40-PLRBK	1421460	632	HC-M-02-CT-M	1414360	575	HC-M-PN2-6,00-ST	1676750	593	HC-STA-B06-SLWSC-2SSM32-ELC-AL	1412833	647
HC-EVO-B24-SHWSC-2SSM25-PLRBK	1421369	632	HC-M-02-CT-M-HV-16	1417408	579	HC-M-PN3-1,60-BU	1663514	593	HC-STA-B06PT-BWSC-LT-M20-ELCAL	1416344	647
HC-EVO-B24-SHWSC-2SSM32-PLRBK	1421368	632	HC-M-02-EMC-F	1417376	583	HC-M-PN3-1,60-BU-V	1663543	593	HC-STA-B10-BFDC-ELC-AL	1411323	613
HC-EVO-B24-SHWSC-2SSM40-PLRBK	1407664	632	HC-M-02-EMC-M	1417374	583	HC-M-PN3-1,60-ST	1663488	593	HC-STA-B10-BWD-ELC-AL	1411322	609
HC-EVO-B24PT-BWD-HH-M32-PLRBK	1407713	646	HC-M-02-PN-M-F	1417434	593	HC-M-PN3-3,00-BU	1663527	593	HC-STA-B10-BWS-ELC-AL	1411320	605
HC-EVO-B24PT-BWSC-HH-M32-PLRBK	1408794	646	HC-M-03-CT-F	1414359	575	HC-M-PN3-3,00-BU-V	1663556	593	HC-STA-B10-BWSC-ELC-AL	1411321	605
HC-EVO-D15-BWSC-PLR-BK	1411336	526	HC-M-03-CT-M	1414358	575	HC-M-PN3-3,00-ST	1663491	593	HC-STA-B10-CHWD-1TTM20-ELC-AL	1412578	609
HC-EVO-D15-BWSC-PLR-BK	1411337	526	HC-M-03-PN-M-F	1417433	593	HC-M-PN3-4,00-BU	1663530	593	HC-STA-B10-CHWD-1TTM25-ELC-AL	1412579	609
HC-EVO-D15-CHWS-PL-BK	1411338	526	HC-M-03/04-CT-F	1414365	575	HC-M-PN3-4,00-BU-V	1663569	593	HC-STA-B10-CHWD-1TTM32-ELC-AL	1412580	609
HC-EVO-D15-HHFS-PL-BK	1411340	524	HC-M-03/04-CT-M	1414364	575	HC-M-PN3-4,00-BU-V	1663501	593	HC-STA-B10-CHWD-1TTP16-ELC-AL	1412581	609
HC-EVO-D15-SLWS-2SSM20-PLR-BK	1421463	526	HC-M-04-BU-KOAX-50	1676802	589	HC-M-RJ45-08-GC-F/F	1419886	591	HC-STA-B10-CHWD-1TTP21-ELC-AL	1412582	609
HC-EVO-D15-SLWS-2SSM25-PLR-BK	1411341	526	HC-M-04-BU-KOAX-75	1686258	589	HC-M-RJ45-08-M	1419887	591	HC-STA-B10-CHWD-1TTP29-ELC-AL	1412583	609
HC-EVO-D15-SLWSC-2SSM20-PLR-BK	1421465	526	HC-M-04-CT-F	1414363	575	HC-M-RJ45-AD-PC-M	1419885	591	HC-STA-B10-CHWS-1TTM20-ELC-AL	1412584	607
HC-EVO-D15-SLWSC-2SSM25-PLR-BK	1411343	526	HC-M-04-CT-M	1414362	575	HC-M-RJ45-AD-PC-M	1419888	591	HC-STA-B10-CHWS-1TTM25-ELC-AL	1412585	607
HC-EVO-D25-BWSC-PLR-BK	1411344	530	HC-M-04-KT-F	1417370	589	HC-M-RJ45-OC-PC-M	1419888	591	HC-STA-B10-CHWS-1TTM32-ELC-AL	1412586	607
HC-EVO-D25-BWSC-PLR-BK	1411345	530	HC-M-04-KT-M	1417371	589	HC-MOD-K-CP	1408562	656	HC-STA-B10-CHWS-1TTP16-ELC-AL	1412587	607
HC-EVO-D25-CHWS-PLR-BK	1411346	530	HC-M-04-ST-KOAX-50	1676815	589	HC-Q 12-COD	1409435	656	HC-STA-B10-CHWS-1TTP21-ELC-AL	1412588	607
HC-EVO-D25-HHFS-PL-BK	1411347	528	HC-M-04-ST-KOAX-75	1686245	589	HC-Q-RJ45 GC-F/F	1422590	513	HC-STA-B10-CHWS-1TTP29-ELC-AL	1412589	607
HC-EVO-D25-SLWS-2SSM20-PLR-BK	1421466	530	HC-M-05-PT-F	1417373	577	HC-Q-RJ45-08-M	1077117	513	HC-STA-B10-DC-PL	1421101	655
HC-EVO-D25-SLWS-2SSM25-PLR-BK	1411348	530	HC-M-05-PT-M	1417372	577	HC-Q-RJ45-AD-PC-M	1077120	513	HC-STA-B10-HHFD-1STM25-EL-AL	1412592	610
HC-EVO-D25-SLWSC-2SSM20-PLR-BK	1421467	530	HC-M-05L-TPT-F	1423962	577	HC-Q-RJ45I-AD-08-PC-M	1077119	513	HC-STA-B10-HHFD-1STM32-EL-AL	1412593	610
HC-EVO-D25-SLWSC-2SSM25-PLR-BK	1411349	530	HC-M-05L-TPT-M	1423961	577	HC-Q2-1-CT-F	1419895	511	HC-STA-B10-HHFD-1STP21-EL-AL	1412594	610
HC-EVO-M1-BWS-PLRBK	1424437	595	HC-M-06-CT-F	1414367	579	HC-Q2-1-CT-M	1419893	511	HC-STA-B10-HHFD-1STP29-EL-AL	1412595	610
HC-EVO-M1-HHFS-PLBK	1424436	595	HC-M-06-CT-M	1414366	579	HC-Q03-I-CT-F	1419897	511	HC-STA-B10-HHFD-1TTM25-EL-AL	1412596	610
HC-HS 2-CP	1586280	656	HC-M-06-PT-F	1424224	577	HC-Q03-I-CT-M	1419896	511	HC-STA-B10-HHFD-1TTM32-EL-AL	1412597	610
HC-HS 2-D7-EBUS	1586264	511	HC-M-06-PT-M	1424225	577	HC-Q04-I-CT-F	1419899	511	HC-STA-B10-HHFD-1TTP21-EL-AL	1412598	610
HC-HS 2-D7-ESTS	1586277	511	HC-M-06P-CT-F	1414369	579	HC-Q04-I-CT-M	1419898	511	HC-STA-B10-HHFD-1TTP29-EL-AL	1412599	610
HC-HS-PES	1586219	662	HC-M-06P-CT-M	1414368	579	HC-Q05-I-CT-F	1406537	509	HC-STA-B10-HHFD-BLANK-EL-AL	1419979	610
HC-HS06-I-UT-F	1406530	563	HC-M-08-CT-F	1414371	579	HC-Q05-I-CT-M	1406538	509	HC-STA-B10-HHFS-1STM25-EL-AL	1412600	606
HC-HS06-I-UT-F 7-12	1406533	563	HC-M-08-CT-M	1414370	579	HC-Q07-I-CT-F	1418623	507	HC-STA-B10-HHFS-1STM32-EL-AL	1412601	606
HC-HS06-I-UT-M	1406531	563	HC-M-08-EMC-DSUB-F	1066080	583	HC-Q07-I-CT-M	1418624	507	HC-STA-B10-HHFS-1STP21-EL-AL	1412602	606
HC-HS06-I-UT-M 7-12	1406534	563	HC-M-08-EMC-DSUB-M	1066082	583	HC-COM-Q08-I-CT-F	1079547	651	HC-STA-B10-HHFS-1STP29-EL-AL	1412603	606
HC-HV03-I-CT-F	1405261	561	HC-M-08-GBIT-CT-F	1417303	587	HC-COM-Q08-I-CT-M	1079548	651	HC-STA-B10-HHFS-1TTM25-EL-AL	1412604	606
HC-HV03-I-CT-M	1405260	561	HC-M-08-GBIT-CT-M	1417302	587	HC-COM-Q08-I-PT-F	1079554	649	HC-STA-B10-HHFS-1TTM32-EL-AL	1412605	606
HC-HV03-I-PT-F	1407743	559	HC-M-08-PT-F	1424226	577	HC-COM-Q08-I-PT-M	1079553	649	HC-STA-B10-HHFS-1TTP21-EL-AL	1412606	606
HC-HV03-I-PT-M	1407739	559	HC-M-08-PT-M	1424227	577	HC-Q12-I-CT-F	1418625	507	HC-STA-B10-HHFS-1TTP29-EL-AL	1412607	606
HC-HV06-I-CT-F	1405263	561	HC-M-12-CT-F	1414355	581	HC-Q12-I-CT-M	1418626	507	HC-STA-B10-HHFS-BLANK-EL-AL	1419903	606
HC-HV06-I-CT-M	1405262	561	HC-M-12-CT-M	1414354	581	HC-COM-Q4/2-I-AT/PT-F	1079557	649	HC-STA-B10-HHWD-1STM25-EL-AL	1412608	614
HC-HV06-I-PT-F	1407744	559	HC-M-12-PT-F	1424228	577	HC-COM-Q4/2-I-AT/PT-M	1079558	649	HC-STA-B10-HHWD-1STM32-EL-AL	1412609	614
HC-HV06-I-PT-M	1407740	559	HC-M-12-PT-M	1424246	577	HC-COM-Q4/2-I-CT-F	1079556	651	HC-STA-B10-HHWD-1STP21-EL-AL	1412610	614
HC-HV10-I-CT-F	1405265	561	HC-M-17-CT-F	1414357	581	HC-COM-Q4/2-I-CT-M	1079555	651	HC-STA-B10-HHWD-1STP29-EL-AL	1412611	614
HC-HV10-I-CT-M	1405264	561	HC-M-17-CT-M	1414356	581	HC-STA-B06-BWS-ELC-AL	1411318	599	HC-STA-B10-HHWD-1TTM25-EL-AL	1412612	614
HC-HV10-I-PT-F	1407745	559	HC-M-20-CT-F	1414373	579	HC-STA-B06-BWSC-ELC-AL	1411319	599	HC-STA-B10-HHWD-1TTM32-EL-AL	1412613	614
HC-HV10-I-PT-M	1407741	559	HC-M-20-CT-M	1414372	579	HC-STA-B06-CHWS-1TTM20-ELC-AL	1412555	599	HC-STA-B10-HHWD-1TTP21-EL-AL	1412614	614
HC-K 4/0-EBUS	1679427	565	HC-M-25-CT-F	1414375	587	HC-STA-B06-CHWS-1TTM25-ELC-AL	1412556	599	HC-STA-B10-HHWD-1TTP29-EL-AL	1412615	614
HC-K 4/0-ESTS	1679414	565	HC-M-25-CT-M	1414374	587	HC-STA-B06-CHWS-1TTM32-ELC-AL	1412557	599	HC-STA-B10-HHWD-BLANK-EL-AL	1	

Index

Alphabetical

Type	Order No.	Page	Type	Order No.	Page	Type	Order No.	Page	Type	Order No.	Page
HC-STA-B10-HLFS-1STM20-EL-AL	1412624	606	HC-STA-B16-HHWD-1TTP21-EL-AL	1412715	628	HC-STA-B24-HHFS-1STP21-EL-AL	1412759	634	HC-STA-B32-HHFD-1STP29-EL-AL	1424833	644
HC-STA-B10-HLFS-1STM25-EL-AL	1412625	606	HC-STA-B16-HHWD-1TTP29-EL-AL	1412716	628	HC-STA-B24-HHFS-1STP29-EL-AL	1412760	634	HC-STA-B32-HHFD-1STP36-EL-AL	1424834	644
HC-STA-B10-HLFS-1STP16-EL-AL	1412627	606	HC-STA-B16-HHWD-BLANK-EL-AL	1420044	628	HC-STA-B24-HHFS-1TTM32-EL-AL	1412761	634	HC-STA-B32-HHFD-1TTP24-EL-AL	1424835	644
HC-STA-B10-HLFS-1STP21-EL-AL	1412628	606	HC-STA-B16-HLFD-1STM25-EL-AL	1412717	624	HC-STA-B24-HHFS-1TTM40-EL-AL	1412098	634	HC-STA-B32-HHFD-1TTM32-EL-AL	1424830	644
HC-STA-B10-HLFS-1TTM20-EL-AL	1412629	606	HC-STA-B16-HLFD-1STM32-EL-AL	1412718	624	HC-STA-B24-HHFS-1TTP21-EL-AL	1412762	634	HC-STA-B32-HHFD-1TTM40-EL-AL	1424831	644
HC-STA-B10-HLFS-1TTM25-EL-AL	1412630	606	HC-STA-B16-HLFD-1STP16-EL-AL	1412719	624	HC-STA-B24-HHFS-1TTP29-EL-AL	1412763	634	HC-STA-B32-HHFD-1TTM50-EL-AL	1424832	644
HC-STA-B10-HLFS-1TTP16-EL-AL	1412631	606	HC-STA-B16-HLFD-1STP21-EL-AL	1412720	624	HC-STA-B24-HHFS-BLANK-EL-AL	1419957	634	HC-STA-B32-HHFD-1TTP29-EL-AL	1424827	644
HC-STA-B10-HLFS-1TTP21-EL-AL	1412632	606	HC-STA-B16-HLFD-1TTM25-EL-AL	1412721	624	HC-STA-B24-HHWD-1STM32-EL-AL	1412764	642	HC-STA-B32-HHFD-1TTP36-EL-AL	1424828	644
HC-STA-B10-HLFS-BLANK-EL-AL	1419902	606	HC-STA-B16-HLFD-1TTM32-EL-AL	1412722	624	HC-STA-B24-HHWD-1STM40-EL-AL	1412766	642	HC-STA-B32-HHFD-1TTP42-EL-AL	1424829	644
HC-STA-B10-HLWD-1STM20-EL-AL	1412633	614	HC-STA-B16-HLFD-1TTP16-EL-AL	1412723	624	HC-STA-B24-HHWD-1STP21-EL-AL	1412767	642	HC-STA-B32-SHWD-2SSM32-ELC-AL	1424848	644
HC-STA-B10-HLWD-1STM25-EL-AL	1412634	614	HC-STA-B16-HLFD-1TTP21-EL-AL	1412724	624	HC-STA-B24-HHWD-1STP29-EL-AL	1412768	642	HC-STA-B32-SHWD-2SSM40-ELC-AL	1424849	644
HC-STA-B10-HLWD-1STP16-EL-AL	1412635	614	HC-STA-B16-HLFD-BLANK-EL-AL	1419999	624	HC-STA-B24-HHWD-1TTM32-EL-AL	1412769	642	HC-STA-B32-SHWD-2SSP29-ELC-AL	1424846	644
HC-STA-B10-HLWD-1STP21-EL-AL	1412636	614	HC-STA-B16-HLFS-1STM25-EL-AL	1412725	620	HC-STA-B24-HHWD-1TTM40-EL-AL	1412770	642	HC-STA-B32-SHWD-2SSP36-ELC-AL	1424847	644
HC-STA-B10-HLWD-1TTM20-EL-AL	1412637	614	HC-STA-B16-HLFS-1STM32-EL-AL	1412726	620	HC-STA-B24-HHWD-1TTP21-EL-AL	1412771	642	HC-STA-B48-HHFS-EMC-AL	1424863	645
HC-STA-B10-HLWD-1TTM25-EL-AL	1412638	614	HC-STA-B16-HLFS-1STP16-EL-AL	1412727	620	HC-STA-B24-HHWD-1TTP29-EL-AL	1412772	642	HC-STA-B48-BWSC-EMC-AL	1424864	645
HC-STA-B10-HLWD-1TTP16-EL-AL	1412639	614	HC-STA-B16-HLFS-1STP21-EL-AL	1412728	620	HC-STA-B24-HHWD-BLANK-EL-AL	1420047	642	HC-STA-B48-HHFS-1STM32-EM-AL	1424860	645
HC-STA-B10-HLWD-1TTP21-EL-AL	1412640	614	HC-STA-B16-HLFS-1TTM25-EL-AL	1412729	620	HC-STA-B24-HLFD-1STM25-EL-AL	1412773	638	HC-STA-B48-HHFS-1STM40-EM-AL	1424861	645
HC-STA-B10-SHWD-2SSM25-ELC-AL	1082598	609	HC-STA-B16-HLFS-1TTM32-EL-AL	1412730	620	HC-STA-B24-HLFD-1STM32-EL-AL	1412774	638	HC-STA-B48-HHFS-1TTM32-EM-AL	1424862	645
HC-STA-B10-SHWD-2SSM32-ELC-AL	1082599	609	HC-STA-B16-HLFS-1TTP16-EL-AL	1412731	620	HC-STA-B24-HLFD-1STP16-EL-AL	1412775	638	HC-STA-B48-HHFS-1STP29-EM-AL	1424857	645
HC-STA-B10-SHWD-2SSM40-ELC-AL	1083164	609	HC-STA-B16-HLFS-1TTP21-EL-AL	1412732	620	HC-STA-B24-HLFD-1STP21-EL-AL	1412776	638	HC-STA-B48-HHFS-1STP36-EM-AL	1424858	645
HC-STA-B10-SHWS-2SSM25-ELC-AL	1082578	605	HC-STA-B16-HLFS-BLANK-EL-AL	1419905	620	HC-STA-B24-HLFD-1TTM25-EL-AL	1412778	638	HC-STA-B48-HHFS-1STP42-EM-AL	1424859	645
HC-STA-B10-SHWS-2SSM32-ELC-AL	1082579	605	HC-STA-B16-HLWD-1TTM25-EL-AL	1412733	628	HC-STA-B24-HLFD-1TTM32-EL-AL	1412779	638	HC-STA-B48-HHFS-1TTM32-EM-AL	1424854	645
HC-STA-B10-SHWS-2SSM40-ELC-AL	1082580	605	HC-STA-B16-HLWD-1STM32-EL-AL	1412734	628	HC-STA-B24-HLFD-1TTP16-EL-AL	1412780	638	HC-STA-B48-HHFS-1TTM40-EM-AL	1424855	645
HC-STA-B10-SHWS-2SSM40-ELC-AL	1082580	605	HC-STA-B16-HLWD-1STP16-EL-AL	1412735	628	HC-STA-B24-HLFD-1TTP21-EL-AL	1412781	638	HC-STA-B48-HHFS-1TTM50-EM-AL	1424856	645
HC-STA-B10-SHWSC-2SSM25-ELC-AL	1082582	605	HC-STA-B16-HLWD-1STP21-EL-AL	1412737	628	HC-STA-B24-HLFD-1TTP29-EL-AL	1412782	638	HC-STA-B48-HHFS-1TTP29-EM-AL	1424851	645
HC-STA-B10-SHWSC-2SSM32-ELC-AL	1082583	605	HC-STA-B16-HLWD-1TTM25-EL-AL	1412738	628	HC-STA-B24-HLFD-BLANK-EL-AL	1420010	638	HC-STA-B48-HHFS-1TTP36-EM-AL	1424852	645
HC-STA-B10-SHWSC-2SSM40-ELC-AL	1082585	605	HC-STA-B16-HLWD-1TTM32-EL-AL	1412739	628	HC-STA-B24-HLFS-1STM25-EL-AL	1412783	634	HC-STA-B48-HHFS-1TTP42-EM-AL	1424853	645
HC-STA-B10-SLFCDC-2SSM20-ELC-AL	1412830	613	HC-STA-B16-HLWD-1TTP16-EL-AL	1412740	628	HC-STA-B24-HLFS-1STM32-EL-AL	1412784	634	HC-STA-B48-SHWS-2SSM32-EMC-AL	1424867	645
HC-STA-B10-SLFCDC-2SSM25-ELC-AL	1412831	613	HC-STA-B16-HLWD-1TTP21-EL-AL	1412741	628	HC-STA-B24-HLFS-1STP16-EL-AL	1412785	634	HC-STA-B48-SHWS-2SSM40-EMC-AL	1424868	645
HC-STA-B10-SLFCDC-2SSP16-ELC-AL	1412832	613	HC-STA-B16-HLWD-BLANK-EL-AL	1420036	628	HC-STA-B24-HLFS-1STP21-EL-AL	1412786	634	HC-STA-B48-SHWS-2SSP29-EMC-AL	1424865	645
HC-STA-B10-SLWD-2SSM20-ELC-AL	1412835	609	HC-STA-B16-SHWD-2SSM25-ELC-AL	1082600	623	HC-STA-B24-HLFS-1TTM25-EL-AL	1412788	634	HC-STA-B48-SHWS-2SSP36-EMC-AL	1424866	645
HC-STA-B10-SLWD-2SSM25-ELC-AL	1412836	609	HC-STA-B16-SHWD-2SSM32-ELC-AL	1082601	623	HC-STA-B24-HLFS-1TTM32-EL-AL	1412789	634	HC-STA-B48-SHWS-2SSM32-EMC-AL	1424873	645
HC-STA-B10-SLWD-2SSP16-ELC-AL	1412837	609	HC-STA-B16-SHWD-2SSM40-ELC-AL	1082602	623	HC-STA-B24-HLFS-1TTP16-EL-AL	1412790	634	HC-STA-B48-SHWS-2SSM40-EMC-AL	1424874	645
HC-STA-B10-SLWS-2SSM20-ELC-AL	1412839	605	HC-STA-B16-SHWS-2SSM25-ELC-AL	1082586	619	HC-STA-B24-HLFS-1TTP21-EL-AL	1412791	634	HC-STA-B48-SHWS-2SSP29-EMC-AL	1424869	645
HC-STA-B10-SLWS-2SSM25-ELC-AL	1412840	605	HC-STA-B16-SHWS-2SSM32-ELC-AL	1082587	619	HC-STA-B24-HLFS-1TTP29-EL-AL	1412792	634	HC-STA-B48-SHWS-2SSP36-EMC-AL	1424872	645
HC-STA-B10-SLWS-2SSP16-ELC-AL	1412842	605	HC-STA-B16-SHWS-2SSM40-ELC-AL	1082588	619	HC-STA-B24-HLFS-BLANK-EL-AL	1419937	634	HC-STA-B48-D07-BAWS-EL-AL	1419252	517
HC-STA-B10-SLWSC-2SSM20-ELC-AL	1412844	605	HC-STA-B16-SHWS-2SSM25-ELC-AL	1082589	619	HC-STA-B24-HLWD-1STM25-EL-AL	1412793	642	HC-STA-D07-BAWS-PL-BK	1419266	516
HC-STA-B10-SLWSC-2SSM25-ELC-AL	1412845	605	HC-STA-B16-SHWS-2SSM32-ELC-AL	1082590	619	HC-STA-B24-HLWD-1STM32-EL-AL	1412795	642	HC-STA-D07-BCLFS-PL-BK	1419271	514
HC-STA-B10-SLWSC-2SSP16-ELC-AL	1412846	605	HC-STA-B16-SHWS-2SSM40-ELC-AL	1082591	619	HC-STA-B24-HLWD-1STP16-EL-AL	1412796	642	HC-STA-D07-BCLFS-PLR-BK	1419270	514
HC-STA-B10-PT-BWD-LT-M25-ELCAL	1416355	647	HC-STA-B16-SLFCDC-2SSM25-ELC-AL	1412849	627	HC-STA-B24-HLWD-1TTP21-EL-AL	1412797	642	HC-STA-D07-BWFS-EL-AL	1419249	517
HC-STA-B10-PT-BWD-LT-M25-ELCAL	1416346	647	HC-STA-B16-SLFCDC-2SSM32-ELC-AL	1412850	627	HC-STA-B24-HLWD-1TTM25-EL-AL	1412799	642	HC-STA-D07-BWS-PL-BK	1419265	516
HC-STA-B16-BFDC-ELC-AL	1411328	627	HC-STA-B16-SLFCDC-2SSP16-ELC-AL	1412852	627	HC-STA-B24-HLWD-1TTM32-EL-AL	1412800	642	HC-STA-D07-BWSCF-EL-AL	1419251	517
HC-STA-B16-BWD-ELC-AL	1411327	623	HC-STA-B16-SLFCDC-2SSP21-ELC-AL	1412853	627	HC-STA-B24-HLWD-1TTP16-EL-AL	1412801	642	HC-STA-D07-BWSCF-PL-BK	1419277	516
HC-STA-B16-BWS-ELC-AL	1411324	619	HC-STA-B16-SLWD-2SSM25-ELC-AL	1412855	623	HC-STA-B24-HLWD-1TTP21-EL-AL	1412802	642	HC-STA-D07-BWSCM-EL-AL	1419250	517
HC-STA-B16-BWSC-ELC-AL	1411325	619	HC-STA-B16-SLWD-2SSM32-ELC-AL	1412856	623	HC-STA-B24-HLWD-1TTP29-EL-AL	1412803	642	HC-STA-D07-BWSCM-PL-BK	1419278	516
HC-STA-B16-CHWD-1TTM25-ELC-AL	1412641	623	HC-STA-B16-SLWD-2SSP21-ELC-AL	1412857	623	HC-STA-B24-HLWD-BLANK-EL-AL	1420046	642	HC-STA-D07-CHPWS-1TGM20-EL-AL	1419242	514
HC-STA-B16-CHWD-1TTM32-ELC-AL	1412642	623	HC-STA-B16-SLWS-2SSM25-ELC-AL	1412861	619	HC-STA-B24-SHWS-2SSM40-ELC-AL	1082603	637	HC-STA-D07-CHPWS-1TGM25-PL-BK	1419269	515
HC-STA-B16-CHWD-1TTP21-ELC-AL	1412643	623	HC-STA-B16-SLWS-2SSM32-ELC-AL	1412862	619	HC-STA-B24-SHWD-2SSM32-ELC-AL	1082604	637	HC-STA-D07-CHWS-1TGM20-PL-BK	1419259	516
HC-STA-B16-CHWD-1TTP29-ELC-AL	1412644	623	HC-STA-B16-SLWS-2SSP21-ELC-AL	1412863	619	HC-STA-B24-SHWD-2SSM40-ELC-AL	1082605	637	HC-STA-D07-CHWS-1TGM25-PL-BK	1419260	516
HC-STA-B16-CHWS-1TTM25-ELC-AL	1412645	619	HC-STA-B16-SLWSC-2SSM25-ELC-AL	1412865	619	HC-STA-B24-SHWS-2SSM25-ELC-AL	1085185	635	HC-STA-D07-CHWS-1TTM20-EL-AL	1419238	517
HC-STA-B16-CHWS-1TTM32-ELC-AL	1412646	619	HC-STA-B16-SLWSC-2SSM32-ELC-AL	1412866	619	HC-STA-B24-SHWS-2SSM32-ELC-AL	1082592	633	HC-STA-D07-CHWS-1TTM25-EL-AL	1419239	517
HC-STA-B16-CHWS-1TTP21-ELC-AL	1412647	619	HC-STA-B16-SLWSC-2SSP21-ELC-AL	1412867	619	HC-STA-B24-SHWS-2SSM40-ELC-AL	1082593	633	HC-STA-D07-CHWS-1TTP11-EL-AL	1419240	517
HC-STA-B16-CHWS-1TTP29-ELC-AL	1412648	619	HC-STA-B16-PT-BWD-LT-M25-ELCAL	1416357	647	HC-STA-B24-SHWS-2SSM25-ELC-AL	1082595	633	HC-STA-D07-CHWSCF-1TGM20-PL-BK	1419261	516
HC-STA-B16-DC-PL	1421102	655	HC-STA-B16-PT-BWD-LT-M25-ELCAL	1416349	647	HC-STA-B24-SHWS-2SSM32-ELC-AL	1082596	633	HC-STA-D07-CHWSCF-1TGM25-PL-BK	1419262	516
HC-STA-B16-HHFD-1STM32-EL-AL	1412649	624	HC-STA-B24-BFDC-ELC-AL	1411332	641	HC-STA-B24-SLWD-2SSM40-ELC-AL	1082597	633	HC-STA-D07-CHWSCF-1TTM20-EL-AL	1419243	517
HC-STA-B16-HHFD-1STM40-EL-AL	1412650	624	HC-STA-B24-BWD-ELC-AL	1411331	637	HC-STA-B24-SLFCDC-2SSM25-ELC-AL	1412869	641	HC-STA-D07-CHWSCF-1TTM25-EL-AL	1419244	517
HC-STA-B16-HHFD-1STM50-EL-AL	1082551	624	HC-STA-B24-BWS-ELC-AL	1411329	633	HC-STA-B24-SLFCDC-2SSM32-ELC-AL	1412870	641	HC-STA-D07-CHWSCF-1TTP11-EL-AL	1419245	517
HC-STA-B16-HHFD-1STP21-EL-AL	1412651	624	HC-STA-B24-BWSC-ELC-AL	1411330	633	HC-STA-B24-SLFCDC-2SSP21-ELC-AL	1412871	641	HC-STA-D07-CHWSCM-1TGM20-PL-BK	1419263	516
HC-STA-B16-HHFD-1STP29-EL-AL	1412652	624	HC-STA-B24-CHWD-1TTM32-ELC-AL	1412742	637	HC-STA-B24-SLWD-2SSM25-ELC-AL	1412873	637	HC-STA-D07-CHWSCM-1TGM25-PL-BK	1419264	516
HC-STA-B16-HHFD-1TTM32-EL-AL	1412653	624	HC-STA-B24-CHWD-1TTM40-ELC-AL	1412743	637	HC-STA-B24-SLWD-2SSM32-ELC-AL	1412874	637	HC-STA-D07-CHWSCM-1TTM20-EL-AL	1419246	517
HC-STA-B16-HHFD-1TTM40-EL-AL	1412654	624	HC-STA-B24-CHWD-1TTP21-ELC-AL	1412744	637	HC-STA-B24-SLWD-2SSP21-ELC-AL	1412875	637	HC-STA-D07-CHWSCM-1TTM25-EL-AL	1419247	517
HC-STA-B16-HHFS-1STM20-EL-AL	1082552	624	HC-STA-B24-CHWD-1TTP29-ELC-AL	1412745	637	HC-STA-B24-SLWS-2SSM25-ELC-AL	1412877	633	HC-STA-D07-CHWSCM-1TTP11-EL-AL	1419248	517
HC-STA-B16-HHFS-1STM25-EL-AL	1412669	624	HC-STA-B24-CHWS-1TTM32-ELC-AL	1412746	633	HC-STA-B24-SLWS-2SSM32-ELC-AL	1412878	633	HC-STA-D0		

Type	Order No.	Page	Type	Order No.	Page	Type	Order No.	Page	Type	Order No.	Page
HC-STA-D15-BCSFS-PLR-BK	1424374	527	IPD WD 5P2,5 1,0 M25 GY	1047364	469	K-5E - OE/2,0-C03/M23 FK	1620418	221	K-7E-M23 M9/5,0-D03/M23 F8	1620413	222
HC-STA-D15-BWS-EL-AL	1424362	527	IPD WD 5P2,5 M25 GY	1047344	468	K-5E - OE/2,0-C03/M40 F8	1619329	224	K-7E-M40 M9/010-D03/M40 F8	1620384	225
HC-STA-D15-BWSC-EL-AL	1424363	527				K-5E - OE/2,0-C04/M40 F8	1620311	224	K-7E-M40 M9/010-D04/M40 F8	1620387	225
HC-STA-D15-CHWS-1TTM25-EL-AL	1424361	527				K-5E - OE/2,0-C05/M40 F8	1620316	224	K-7E-M40 M9/010-D05/M40 F8	1620392	225
HC-STA-D15-CHWS-1TTP16-EL-AL	1424360	527				K-5E - OE/2,0-C06/M40 F8	1620319	225	K-7E-M40 M9/010-D06/M40 F8	1620395	225
HC-STA-D15-CLWS-1TTM20-EL-AL	1424359	527				K-5E - OE/5,0-C00/M17 F8	1619308	218	K-7E-M40 M9/2,0-D03/M40 F8	1620382	225
HC-STA-D15-HCLWS-PL-BK	1424375	525				K-5E - OE/5,0-C01/M17 F8	1619311	219	K-7E-M40 M9/2,0-D04/M40 F8	1620385	225
HC-STA-D15-HHFS-1STM25-ELC-AL	1424346	525				K-5E - OE/5,0-C02/M23 F8	1618958	220	K-7E-M40 M9/2,0-D05/M40 F8	1620390	225
HC-STA-D15-HHFS-1STP16-ELC-AL	1424348	525				K-5E - OE/5,0-C02/M23 FK	1620416	221	K-7E-M40 M9/2,0-D06/M40 F8	1620393	225
HC-STA-D15-HHFS-1STP21-ELC-AL	1424349	525				K-5E - OE/5,0-C03/M23 FK	1620397	221	K-7E-M40 M9/5,0-D03/M40 F8	1620386	225
HC-STA-D15-HHFS-1TTM25-ELC-AL	1424351	525				K-5E - OE/5,0-C03/M23 FK	1620419	221	K-7E-M40 M9/5,0-D04/M40 F8	1620389	225
HC-STA-D15-HHFS-1TTP16-ELC-AL	1424353	525				K-5E - OE/5,0-C03/M40 F8	1620309	224	K-7E-M40 M9/5,0-D05/M40 F8	1620391	225
HC-STA-D15-HHFS-1TTP21-ELC-AL	1424358	525				K-5E - OE/5,0-C04/M40 F8	1620313	224	K-7E-M40 M9/5,0-D06/M40 F8	1620394	225
HC-STA-D15-HHFS-1STM20-ELC-AL	1424345	525				K-5E - OE/5,0-C05/M40 F8	1620317	224	K-8E-M23M8/5,0-H00/M23F8-C5-S	1622249	226
HC-STA-D15-HLFS-1STP16-ELC-AL	1424347	525				K-5E - OE/5,0-C06/M40 F8	1620320	225	K-8E-M23M8/10,0-H00/OE-C5-S	1622229	226
HC-STA-D15-HLFS-1TTM20-ELC-AL	1424350	525				K-5E-M17 M9/010-C00/M17 F8	1619318	218	K-8E-M23M8/2,0-H00/M23F8-C5-S	1622247	226
HC-STA-D15-HLFS-1TTP13-ELC-AL	1424352	525				K-5E-M17 M9/010-C01/M17 F8	1619322	219	K-8E-M23M8/2,0-H00/OE-C5-S	1622227	226
HC-STA-D15-SLWSC-2SSM20-EL-AL	1424369	527				K-5E-M17 M9/010-C02/M23 F8	1619316	218	K-8E-M23M8/5,0-H00/M23F8-C5-S	1622248	226
HC-STA-D15-SLWSC-2SSM25-EL-AL	1424365	527				K-5E-M17 M9/2,0-C01/M17 F8	1619319	219	K-8E-M23M8/5,0-H00/OE-C5-S	1622228	226
HC-STA-D15-SLWSC-2SSP16-EL-AL	1424366	527				K-5E-M17 M9/5,0-C00/M17 F8	1619317	218	K-8E-M23M9/10,0-H00/M23F8-C5-S	1622246	226
HC-STA-D15-SLWSC-2SSP21-EL-AL	1424367	527				K-5E-M17 M9/5,0-C01/M17 F8	1619321	219	K-8E-M23M9/2,0-H00/M23F8-C5-S	1622244	226
HC-STA-D15-SLWSC-2SSM20-EL-AL	1424368	527				K-5E-M23 M9/010-E00/M23 F8-N2	1618966	220	K-8E-M23M8/10,0-H00/M23F8-C5-S	1622245	226
HC-STA-D15-SLWSC-2SSM25-EL-AL	1424371	527				K-5E-M23 M9/2,0-E00/M23 F8-N2	1619292	217	K-8E-M23MK/2,0-H00/M23FK-C5-S	1622250	226
HC-STA-D15-SLWSC-2SSP16-EL-AL	1424372	527				K-12-M23 M9/2,0-E00/M23 F8-N2	1619289	216	K-8E-M23MK/5,0-H00/M23FK-C5-S	1622251	226
HC-STA-D15-SLWSC-2SSP21-EL-AL	1424373	527				K-12-M23 M9/5,0-E00/M23 F8	1619293	217	K-8E-M23MK/10,0-H00/M23FK-C5-S	1622252	226
HC-STA-D25-BCSFS-PLR-BK	1424401	531				K-12-M23 M9/5,0-E00/M23 F8-N2	1619290	216	K-8E-M23M8/10,0-H00/M23F8-C5-S	1622243	227
HC-STA-D25-BWS-EL-AL	1424391	531				K-17 - OE/010-E01/M17 F8	1624782	216	K-8E-M23MK/2,0-H00/OE-C5-S	1622233	227
HC-STA-D25-BWSC-EL-AL	1424390	531				K-17 - OE/010-E01/M23 F8	1619279	217	K-8E-M23MK/5,0-H00/OE-C5-S	1622234	227
HC-STA-D25-CHWS-1TTM25-EL-AL	1424387	531				K-17 - OE/010-E01/M23 FK	1619288	217	K-8E-OE/10,0-H00/M23F8-C5-S	1622226	226
HC-STA-D25-CHWS-1TTP16-EL-AL	1424389	531				K-17 - OE/2,0-E01/M17 F8	1624780	216	K-8E-OE/10,0-H00/M23FK-C5-S	1622232	226
HC-STA-D25-HCLWS-PL-BK	1424400	529				K-17 - OE/2,0-E01/M23 F8	1619277	217	K-8E-OE/2,0-H00/M23F8-C5-S	1622224	226
HC-STA-D25-HHFS-1STM25-ELC-AL	1424377	529				K-17 - OE/2,0-E01/M23 FK	1619286	217	K-8E-OE/2,0-H00/M23FK-C5-S	1622230	226
HC-STA-D25-HHFS-1STP16-ELC-AL	1424379	529				K-17 - OE/5,0-E01/M17 F8	1624781	216	K-8E-OE/5,0-H00/M23F8-C5-S	1622225	226
HC-STA-D25-HHFS-1STP21-ELC-AL	1424380	529				K-17 - OE/5,0-E01/M23 F8	1619278	217	K-8E-OE/5,0-H00/M23FK-C5-S	1622231	226
HC-STA-D25-HHFS-1TTM25-ELC-AL	1424382	529				K-17 - OE/5,0-E01/M23 FK	1619287	217	KC-88014311/1,00	1623127	118
HC-STA-D25-HHFS-1TTP16-ELC-AL	1424384	529				K-17-M17 M9/010-E01/M17 F8	1624784	216	KC-88014311/100,00	1623089	118
HC-STA-D25-HHFS-1TTP21-ELC-AL	1424385	529				K-17-M17 M9/5,0-E01/M17 F8	1624778	216	KC-88014311/20,00	1622080	118
HC-STA-D25-HLFS-1STM20-ELC-AL	1424376	529				K-17-M17 M9/5,0-E01/M17 F8	1624783	216	KC-88014448/1,00	1627298	126
HC-STA-D25-HLFS-1STP16-ELC-AL	1424378	529				K-17-M23 M9/010-E01/M23 F8	1619297	217	KC-88014448/20,00	1627299	126
HC-STA-D25-HLFS-1TTM20-ELC-AL	1424381	529				K-17-M23 M9/2,0-E01/M23 F8	1619295	217	KDT-ST 1	1410220	682
HC-STA-D25-HLFS-1TTP16-ELC-AL	1424383	529				K-17-M23 M9/5,0-E01/M23 F8	1619296	217	KDT-ST 3	3063921	682
HC-STA-D25-SLWSC-2SSM20-EL-AL	1424392	531				K-3E - OE/010-A00/M23 F8	1624772	220	KDT-ST 4	3063934	682
HC-STA-D25-SLWSC-2SSM25-EL-AL	1424393	531				K-3E - OE/010-B00/M17 F8	1619300	218	KDT-ST 5	3063947	682
HC-STA-D25-SLWSC-2SSP16-EL-AL	1424394	531				K-3E - OE/010-B01/M17 F8	1619303	218	KDT-ST 6	3063950	682
HC-STA-D25-SLWSC-2SSP21-EL-AL	1424395	531				K-3E - OE/2,0-A00/M23 F8	1624771	220	KDT-ST 7	3063963	682
HC-STA-D25-SLWSC-2SSM20-EL-AL	1424396	531				K-3E - OE/2,0-B00/M17 F8	1619298	218	KDT-ST 8	3063976	682
HC-STA-D25-SLWSC-2SSM25-EL-AL	1424397	531				K-3E - OE/2,0-B01/M17 F8	1619301	218	KDT-ST 9	3063989	682
HC-STA-D25-SLWSC-2SSP16-EL-AL	1424398	531				K-3E - OE/5,0-A00/M23 F8	1619622	220	KDT-ST 10	3063992	682
HC-STA-D25-SLWSC-2SSP21-EL-AL	1424399	531				K-3E - OE/5,0-B00/M17 F8	1619299	218	KDT-ST 11	3064001	682
HC-STA-D50-BCSFD-PL-BK	1424417	532				K-3E - OE/5,0-B01/M17 F8	1619302	218	KDT-ST 12	3062016	682
HC-STA-D50-BWD-ELC-AL	1424412	533				K-3E-M17 M9/010-B00/M17 F8	1619306	218	KDT-ST 13	3062029	682
HC-STA-D50-HHFD-1STM25-EL-AL	1424403	532				K-3E-M17 M9/010-B01/M17 F8	1619328	218	KDT-ST 14	3062032	682
HC-STA-D50-HHFD-1STM32-EL-AL	1424404	532				K-3E-M17 M9/2,0-B00/M17 F8	1619304	218	KDT-ST 15	3062045	682
HC-STA-D50-HHFD-1STP21-EL-AL	1424406	532				K-3E-M17 M9/2,0-B01/M17 F8	1619326	218	KDT-ST 16	3062058	682
HC-STA-D50-HHFD-1TTP29-EL-AL	1424407	532				K-3E-M17 M9/5,0-B00/M17 F8	1619305	218	KDT-ST 17	3062061	682
HC-STA-D50-HHFD-1TTM25-EL-AL	1424408	532				K-3E-M17 M9/5,0-B01/M17 F8	1619327	218	KEL-EMV 16-4	3063507	682
HC-STA-D50-HHFD-1TTM32-EL-AL	1424409	532				K-3E-M23 M9/010-A00/M23 F8	1624774	220	KEL-EMV 24-5	3063510	682
HC-STA-D50-HHFD-1TTP21-EL-AL	1424410	532				K-3E-M23 M9/2,0-A00/M23 F8	1624773	220	KEL-EMV-F	3063523	682
HC-STA-D50-HHFD-1TTP29-EL-AL	1424411	532				K-3E-M23 M9/5,0-A00/M23 F8	1619606	220	SKS 1	1685013	314
HC-STA-D50-HLFD-1STM25-EL-AL	1424402	532				K-4E - OE/010-A01/M23 F8	1625775	220	KV-DI-PG16-1XASI	1582462	488
HC-STA-D50-HLFD-1STP21-EL-AL	1424405	532				K-4E - OE/2,0-A01/M23 F8	1625776	220	KV-DI-PG16-2XASI	1582464	488
HC-STA-D50-SHWD-2SSM25-ELC-AL	1424413	533				K-4E - OE/5,0-A01/M23 F8	1625777	220	KW-M-M50-GD-(8)	1636509	706
HC-STA-D50-SHWD-2SSM32-ELC-AL	1424414	533				K-4E-M23 M9/010-A01/M23 F8	1625780	220	KW-M-M50-GD-(10)	1636512	706
HC-STA-D50-SHWD-2SSP21-ELC-AL	1424415	533				K-4E-M23 M9/2,0-A01/M23 F8	1625779	220	KW-M-M50-GD-(2X6)	1636525	706
HC-STA-D50-SHWD-2SSP29-ELC-AL	1424416	533				K-4E-M23 M9/5,0-A01/M23 F8	1625781	220	KW-M-M50-GD-(2X9)	1636538	706
HC-VSH	1660083	537				K-5E - OE/010-C00/M17 F8	1619309	218	M23-06P1N8A8002	1629235	76
						K-5E - OE/010-C01/M17 F8	1619312	219	M23-06P1N8A8002S	1629191	76
						K-5E - OE/010-C02/M23 F8	1618959	220	M23-06P1N8A8003	1629234	76
						K-5E - OE/010-C02/M23 FK	1620417	221	M23-06P1N8A8003S	1629190	76
						K-5E - OE/010-C03/M23 F8	1620398	221			
						K-5E - OE/010-C03/M23 FK	1620420	221			
						K-5E - OE/010-C03/M40 F8	1620310	224			
						K-5E - OE/010-C04/M40 F8	1620314	224			
						K-5E - OE/010-C05/M40 F8	1620318	224			
						K-5E - OE/010-C06/M40 F8	1620322	225			
						K-5E - OE/2,0-C00/M17 F8	1619307	218			
						K-5E - OE/2,0-C01/M17 F8	1619310	219			
						K-5E - OE/2,0-C02/M23 F8	1618958	220			
						K-5E - OE/2,0-C02/M23 FK	1620417	221			
						K-5E - OE/2,0-C03/M23 F8	1620398	221			
						K-5E - OE/2,0-C03/M23 FK	1620420	221			
						K-5E - OE/2,0-C03/M40 F8	1620310	224			
						K-5E - OE/2,0-C04/M40 F8	1620314	224			
				</							

Index

Alphabetical

Type	Order No.	Page	Type	Order No.	Page	Type	Order No.	Page	Type	Order No.	Page
M23-06S1N8A8002	1629239	76	M23-5EP198A8022	1628882	146	MC-25-MULTI-65-PV-LG	1422348	683	NBC-FS/ 2,0-94B/R4MC SCO	1407452	401
M23-06S1N8A8002S	1629187	76	M23-5EP198A8022S	1628874	146	MC-25-MULTI-65-PVO-BK	1422349	683	NBC-FS/ 2,0-94B/R4QC SCO	1407460	401
M23-06S1N8A8003	1629238	76	M23-5EP198A8023	1628881	146	MC-25/27-MULTI-67-PV-LG	1415236	683	NBC-FS/ 2,0-94B/R4RC SCO	1407456	401
M23-06S1N8A8003S	1629186	76	M23-5EP198A8023S	1628873	146	MC-25/27-MULTI-67-PVO-BK	1415237	683	NBC-FS/ 5,0-94B/R4AC SCO	1407445	401
M23-06S1N8A8004	1629237	76	M23-5EP198A8024	1628880	146	MC-3/7-MULTI-67-PV-LG	1415234	683	NBC-FS/ 5,0-94B/R4MC SCO	1407453	401
M23-06S1N8A8004S	1629185	76	M23-5EP198A8024S	1628872	146	MC-3/7-MULTI-67-PVO-BK	1415235	683	NBC-FS/ 5,0-94B/R4QC SCO	1407461	401
M23-06S1N8A800DU	1629236	76	M23-5EP198A80DN	1628879	146	MC-35-MULTI-65-PV-LG	1422350	683	NBC-FS/ 5,0-94B/R4RC SCO	1407457	401
M23-06S1N8A80DUS	1629184	76	M23-5EP198A80DNS	1628871	146	MC-35-MULTI-65-PVO-BK	1422351	683	NBC-FS/10,0-94B/R4AC SCO	1407446	401
M23-07P1N8A8002	1629227	76	M23-5EP198A8L22	1628866	146	MC-35/37-MULTI-67-PV-LG	1415240	683	NBC-FS/10,0-94B/R4MC SCO	1407454	401
M23-07P1N8A8002S	1629179	76	M23-5EP198A8L22S	1628856	146	MC-35/37-MULTI-67-PVO-BK	1415241	683	NBC-FS/10,0-94B/R4QC SCO	1407462	401
M23-07P1N8A8003	1629226	76	M23-5EP198A8L23	1628865	146	MD-INB24-3-SZP-S	1415242	682	NBC-FS/10,0-94B/R4RC SCO	1407458	401
M23-07P1N8A8003S	1629178	76	M23-5EP198A8L23S	1628855	146	MD-INB24-4-SZP-S	1415243	682	NBC-FSD SCO-PN/.....	1408623	397
M23-07P1N8A8004	1629225	76	M23-5EP198A8L24	1628864	146	MG-INC-M16-S67L-PTES-LG	1415186	693	NBC-FSD SCO/.....	1408697	399
M23-07P1N8A8004S	1629177	76	M23-5EP198A8L24S	1628854	146	MG-INC-M20-S67L-PTES-LG	1415187	693	NBC-FSD-R4AC SCO-PN/.....	1408622	397
M23-07P1N8A800DU	1629224	76	M23-5EP198A8L25	1628863	146	MG-INC-M25-M67L-PTES-LG	1415188	693	NBC-FSD-R4AC SCO/.....	1408696	399
M23-07P1N8A80DUS	1629176	76	M23-5EP198A8L25S	1628853	146	MH-10CL-MULTI-55-PV-BK	1424584	683	NBC-FSD-R4ACR SCO-PN/.....	1408621	397
M23-07S1N8A8002	1629231	76	M23-5EP198A8LDL	1628862	146	MH-25-MULTI-65-PV-BK	1424582	683	NBC-FSD-R4MC SCO/.....	1408695	399
M23-07S1N8A8002S	1629183	76	M23-5EP198A8LDLS	1628852	146	MH-27-MULTI-65-PV-BK	1424583	683	NBC-FSD-R4QC SCO-PN/.....	1408618	397
M23-07S1N8A8003	1629230	76	M23-5EP198AA500S	1628487	147	MICROFOX-SP-1	1212487	357	NBC-FSD-R4QC SCO/.....	1408693	399
M23-07S1N8A8003S	1629182	76	M23-5EP198AA600S	1628485	147	MSK 1	1665897	314	NBC-FSD-R4RC SCO-PN/.....	1408619	397
M23-07S1N8A8004	1629229	76	M23-5ES198A8022	1628826	146	MSK 2	1665907	314	NBC-FSD-R4RC SCO/.....	1408694	399
M23-07S1N8A8004S	1629181	76	M23-5ES198A8022S	1628816	146				NBC-FSD/ 1,0-93B/R4AC SCO	1407532	397
M23-07S1N8A800DU	1629228	76	M23-5ES198A8023	1628825	146				NBC-FSD/ 1,0-93B/R4ACR SCO	1407536	397
M23-07S1N8A80DUS	1629180	76	M23-5ES198A8023S	1628817	146				NBC-FSD/ 1,0-93B/R4QC SCO	1407548	397
M23-09P1N8A8002	1629219	76	M23-5ES198A8024	1628824	146				NBC-FSD/ 1,0-93B/R4RC SCO	1407544	397
M23-09P1N8A8002S	1629171	76	M23-5ES198A8024S	1628816	146				NBC-FSD/ 1,0-93E/R4AC SCO	1407384	399
M23-09P1N8A8003	1629218	76	M23-5ES198A80DN	1628823	146				NBC-FSD/ 1,0-93E/R4MC SCO	1407388	399
M23-09P1N8A8003S	1629170	76	M23-5ES198A80DNS	1628815	146				NBC-FSD/ 1,0-93E/R4QC SCO	1407396	399
M23-09P1N8A8004	1629217	76	M23-5ES198A8L22	1628810	146	NBC- 1,0-93B/FSD SCO	1407528	397	NBC-FSD/ 1,0-93E/R4RC SCO	1407392	399
M23-09P1N8A8004S	1629169	76	M23-5ES198A8L22S	1628800	146	NBC- 1,0-93E/FSD SCO	1407380	399	NBC-FSD/ 2,0-93B/R4AC SCO	1407533	397
M23-09P1N8A800DU	1629216	76	M23-5ES198A8L23	1628809	146	NBC- 1,0-94B/FS SCO	1407439	401	NBC-FSD/ 2,0-93B/R4ACR SCO	1407537	397
M23-09P1N8A80DUS	1629168	76	M23-5ES198A8L23S	1628799	146	NBC- 2,0-93B/FSD SCO	1407529	397	NBC-FSD/ 2,0-93B/R4QC SCO	1407549	397
M23-09S1N8A8002	1629223	76	M23-5ES198A8L24	1628808	146	NBC- 2,0-93E/FSD SCO	1407381	399	NBC-FSD/ 2,0-93B/R4RC SCO	1407545	397
M23-09S1N8A8002S	1629175	76	M23-5ES198A8L24S	1628798	146	NBC- 2,0-94B/FS SCO	1407440	401	NBC-FSD/ 2,0-93E/R4AC SCO	1407385	399
M23-09S1N8A8003	1629222	76	M23-5ES198A8L25	1628807	146	NBC- 5,0-93B/FSD SCO	1407530	397	NBC-FSD/ 2,0-93E/R4MC SCO	1407389	399
M23-09S1N8A8003S	1629174	76	M23-5ES198A8L25S	1628797	146	NBC- 5,0-93E/FSD SCO	1407382	399	NBC-FSD/ 2,0-93E/R4QC SCO	1407397	399
M23-09S1N8A8004	1629221	76	M23-5ES198A8LDL	1628806	146	NBC- 5,0-94B/FS SCO	1407441	401	NBC-FSD/ 2,0-93E/R4RC SCO	1407393	399
M23-09S1N8A8004S	1629173	76	M23-5ES198A8LDLS	1628796	146	NBC- 1,0-94F/M12FRX	1080746	403	NBC-FSD/ 5,0-93B/R4AC SCO	1407534	397
M23-09S1N8A800DU	1629220	76	M23-5ES198AA500S	1628491	147	NBC-1,0-94F/M12FSX	1080728	403	NBC-FSD/ 5,0-93B/R4ACR SCO	1407538	397
M23-09S1N8A80DUS	1629172	76	M23-5ES198AA600S	1628489	147	NBC-10,0-93B/FSD SCO	1407531	397	NBC-FSD/ 5,0-93B/R4QC SCO	1407551	397
M23-12P1N8A8002	1629211	76	M23-7EP198A8022	1628878	146	NBC-10,0-93E/FSD SCO	1407383	399	NBC-FSD/ 5,0-93B/R4RC SCO	1407546	397
M23-12P1N8A8002S	1629163	76	M23-7EP198A8022S	1628869	146	NBC-10,0-94B/FS SCO	1407442	401	NBC-FSD/ 5,0-93E/R4AC SCO	1407386	399
M23-12P1N8A8003	1629210	76	M23-7EP198A8023	1628877	146	NBC-10,0-94F/M12FRX	1080750	403	NBC-FSD/ 5,0-93E/R4MC SCO	1407390	399
M23-12P1N8A8003S	1629162	76	M23-7EP198A8023S	1628870	146	NBC-10,0-94F/M12FSX	1080732	403	NBC-FSD/ 5,0-93E/R4QC SCO	1407398	399
M23-12P1N8A8004	1629209	76	M23-7EP198A8024	1628876	146	NBC-2,0-94F/M12FRX	1080747	403	NBC-FSD/ 5,0-93E/R4RC SCO	1407394	399
M23-12P1N8A8004S	1629161	76	M23-7EP198A8024S	1628868	146	NBC-2,0-94F/M12FSX	1080729	403	NBC-FSD/10,0-93B/R4AC SCO	1407535	397
M23-12P1N8A800DU	1629208	76	M23-7EP198A80DN	1628875	146	NBC-5,0-94F/M12FSX	1080748	403	NBC-FSD/10,0-93B/R4ACR SCO	1407539	397
M23-12P1N8A80DUS	1629160	76	M23-7EP198A80DNS	1628867	146	NBC-5,0-94F/M12FSX	1080731	403	NBC-FSD/10,0-93B/R4QC SCO	1407552	397
M23-12P1N8AA500S	1628498	77	M23-7EP198A8L22	1628861	146	NBC-937/...	1408540	392	NBC-FSD/10,0-93B/R4RC SCO	1407547	397
M23-12P1N8AA600S	1628494	77	M23-7EP198A8L22S	1628850	146	NBC-93B/...	1408537	392	NBC-FSD/10,0-93E/R4AC SCO	1407387	399
M23-12S1N8A8002	1629215	76	M23-7EP198A8L23	1628860	146	NBC-93C/...	1408538	392	NBC-FSD/10,0-93E/R4MC SCO	1407391	399
M23-12S1N8A8002S	1629167	76	M23-7EP198A8L23S	1628851	146	NBC-93E/...	1408534	393	NBC-FSD/10,0-93E/R4QC SCO	1407399	399
M23-12S1N8A8003	1629214	76	M23-7EP198A8L24	1628859	146	NBC-93R/...	1408539	392	NBC-FSD/10,0-93E/R4RC SCO	1407395	399
M23-12S1N8A8003S	1629166	76	M23-7EP198A8L24S	1628849	146	NBC-94B/...	1408535	393	NBC-M 8FS-R4AC/.....	1408714	394
M23-12S1N8A8004	1629213	76	M23-7EP198A8L25	1628858	146	NBC-94C/...	1408536	393	NBC-M 8FS/.....	1408716	394
M23-12S1N8A8004S	1629165	76	M23-7EP198A8L25S	1628848	146	NBC-FR SCO-IE/.....	1408657	401	NBC-M 8MS-M 8FS/.....	1408715	394
M23-12S1N8A80DU	1629212	76	M23-7EP198A8LDL	1628857	146	NBC-FR-R4AC SCO-IE/.....	1408655	401	NBC-M 8MS-M 8MS/.....	1408718	394
M23-12S1N8A80DUS	1629164	76	M23-7EP198A8LDLS	1628847	146	NBC-FR-R4MC SCO-IE/.....	1408653	401	NBC-M 8MS-R4AC/.....	1408717	394
M23-12S1N8AA500S	1628499	77	M23-7EP198AA500S	1628486	147	NBC-FR-R4QC SCO-IE/.....	1408651	401	NBC-M 8MS/ 1,0-93B	1407344	394
M23-12S1N8AA600S	1628495	77	M23-7EP198AA600S	1628484	147	NBC-FR-R4RC SCO-IE/.....	1408652	401	NBC-M 8MS/ 1,0-93B/M 8MS	1407348	394
M23-17P1N8A8002	1629203	76	M23-7ES198A8022	1628822	146	NBC-FRD SCO-PN/.....	1408615	397	NBC-M 8MS/ 1,0-93B/R4AC	1407352	394
M23-17P1N8A8002S	1629155	76	M23-7ES198A8022S	1628813	146	NBC-FRD SCO/.....	1408690	399	NBC-M 8MS/ 2,0-93B	1407345	394
M23-17P1N8A8003	1629202	76	M23-7ES198A8023	1628821	146	NBC-FRD-R4AC SCO-PN/.....	1408613	397	NBC-M 8MS/ 2,0-93B/M 8MS	1407349	394
M23-17P1N8A8003S	1629154	76	M23-7ES198A8023S	1628814	146	NBC-FRD-R4AC SCO/.....	1408689	399	NBC-M 8MS/ 2,0-93B/R4AC	1407353	394
M23-17P1N8A8004	1629201	76	M23-7ES198A8024	1628820	146	NBC-FRD-R4ACR SCO-PN/.....	1408612	397	NBC-M 8MS/ 5,0-93B	1407346	394
M23-17P1N8A8004S	1629153	76	M23-7ES198A8024S	1628812	146	NBC-FRD-R4MC SCO-IE/.....	1408688	399	NBC-M 8MS/ 5,0-93B/M 8MS	1407350	394
M23-17P1N8A800DU	1629200	76	M23-7ES198A80DN	1628819	146	NBC-FRD-R4QC SCO-PN/.....	1408609	397	NBC-M 8MS/ 5,0-93B/R4AC	1407354	394
M23-17P1N8A80DUS	1629152	76	M23-7ES198A80DNS	1628811	146	NBC-FRD-R4QC SCO/.....	1408686	399	NBC-M 8MS/.....	1408719	394
M23-17P1N8AA500S	1628496	77	M23-7ES198A8L22	1628805	146	NBC-FRD-R4RC SCO-PN/.....	1408610	397	NBC-M 8MS/10,0-93B	1407347	394
M23-17P1N8AA600S	1628492	77	M23-7ES198A8L22S	1628795	146	NBC-FRD-R4RC SCO/.....	1408687	399	NBC-M 8MS/10,0-93B/M 8MS	1407351	394
M23-17S1N8A8002	1629207	76	M23-7ES198A8L23	1628804	146	NBC-FS SCO-IE/.....	1408665	401	NBC-M 8MS/10,0-93B/R4AC	1407355	394
M23-17S1N8A8002S	1629159	76	M23-7ES198A8L23S	1628794	146	NBC-FS-R4AC SCO-IE/.....	1408664	401	NBC-M12FSX/1,0-94F		

Type	Order No.	Page	Type	Order No.	Page	Type	Order No.	Page	Type	Order No.	Page
NBC-M12MRX/1,0-94F/M12MRX	1080720	403	NBC-MS/ 1,0-94B SCO	1407404	401	NBC-MSD/ 5,0-93E SCO	1407358	399	NBC-R4AC-R4QC-PN4/././...	1411864	397
NBC-M12MRX/10,0-94F	1080719	403	NBC-MS/ 1,0-94B/FS SCO	1407463	401	NBC-MSD/ 5,0-93E/FSD SCO	1407402	399	NBC-R4AC-R4RC-IE4/././...	1411833	398
NBC-M12MRX/10,0-94F/M12MRX	1080723	403	NBC-MS/ 1,0-94B/MS SCO	1407434	401	NBC-MSD/ 5,0-93E/MSD SCO	1407378	399	NBC-R4AC-R4RC-IE8/././...	1411844	400
NBC-M12MRX/2,0-94F	1080717	403	NBC-MS/ 1,0-94B/R4AC SCO	1407414	401	NBC-MSD/ 5,0-93E/R4AC SCO	1407362	399	NBC-R4AC-R4RC-IE8A/././...	1411855	402
NBC-M12MRX/2,0-94F/M12MRX	1080721	403	NBC-MS/ 1,0-94B/R4QC SCO	1407430	401	NBC-MSD/ 5,0-93E/R4MC SCO	1407366	399	NBC-R4AC-R4RC-PN4/././...	1411863	396
NBC-M12MRX/5,0-94F	1080718	403	NBC-MS/ 1,0-94B/R4RC SCO	1407426	401	NBC-MSD/ 5,0-93E/R4QC SCO	1407374	399	NBC-R4AC/0,3-94Z/R4AC	1423032	386
NBC-M12MRX/5,0-94F/M12MRX	1080722	403	NBC-MS/ 2,0-94B SCO	1407405	401	NBC-MSD/ 5,0-93E/R4RC SCO	1407370	399	NBC-R4AC/0,5-94Z/R4AC	1403926	386
NBC-M12MSX/1,0-94F/M12FRX	1080751	403	NBC-MS/ 2,0-94B/FS SCO	1407464	401	NBC-MSD/10,0-93B SCO	1407498	397	NBC-R4AC/1,0-93B/R4AC	1408968	396
NBC-M12MSX/1,0-94F/M12FSX	1080742	403	NBC-MS/ 2,0-94B/MS SCO	1407435	401	NBC-MSD/10,0-93B/FSD SCO	1407556	397	NBC-R4AC/1,0-93E/R4AC	1408933	398
NBC-M12MSX/1,0-94F/M12FRX	1080724	403	NBC-MS/ 2,0-94B/R4AC SCO	1407415	401	NBC-MSD/10,0-93B/MSD SCO	1407527	397	NBC-R4AC/1,0-94B/R4AC	1408950	400
NBC-M12MSX/10,0-94F/M12FRX	1080754	403	NBC-MS/ 2,0-94B/R4MC SCO	1407423	401	NBC-MSD/10,0-93B/R4AC SCO	1407502	397	NBC-R4AC/1,0-94Z/R4AC	1403927	386
NBC-M12MSX/10,0-94F/M12FSX	1080745	403	NBC-MS/ 2,0-94B/R4QC SCO	1407431	401	NBC-MSD/10,0-93B/R4ACR SCO	1407511	397	NBC-R4AC/1,75-94Z/R4AC	1423433	386
NBC-M12MSX/10,0-94F/M12MRX	1080727	403	NBC-MS/ 2,0-94B/R4RC SCO	1407427	401	NBC-MSD/10,0-93B/R4QC SCO	1407523	397	NBC-R4AC/10,0-93B/R4AC	1408971	396
NBC-M12MSX/2,0-94F/M12FRX	1080752	403	NBC-MS/ 5,0-94B SCO	1407406	401	NBC-MSD/10,0-93B/R4RC SCO	1407519	397	NBC-R4AC/10,0-93E/R4AC	1408936	398
NBC-M12MSX/2,0-94F/M12FSX	1080743	403	NBC-MS/ 5,0-94B/FS SCO	1407465	401	NBC-MSD/10,0-93E SCO	1407359	399	NBC-R4AC/10,0-94B/R4AC	1408953	400
NBC-M12MSX/2,0-94F/M12MRX	1080725	403	NBC-MS/ 5,0-94B/MS SCO	1407436	401	NBC-MSD/10,0-93E/FSD SCO	1407403	399	NBC-R4AC/10,0-94Z/R4AC	1403934	386
NBC-M12MSX/5,0-94F/M12FRX	1080753	403	NBC-MS/ 5,0-94B/R4AC SCO	1407416	401	NBC-MSD/10,0-93E/MSD SCO	1407379	399	NBC-R4AC/10G-R4AC/10G-94F/10,0	1408367	402
NBC-M12MSX/5,0-94F/M12FSX	1080754	403	NBC-MS/ 5,0-94B/R4MC SCO	1407424	401	NBC-MSD/10,0-93E/R4AC SCO	1407363	399	NBC-R4AC/10G-R4AC/10G-94F/2,0	1408360	402
NBC-M12MSX/5,0-94F/M12MRX	1080726	403	NBC-MS/ 5,0-94B/R4QC SCO	1407432	401	NBC-MSD/10,0-93E/R4MC SCO	1407367	399	NBC-R4AC/15,0-94Z/R4AC	1410797	386
NBC-M8MRD/1,0-93C	1080526	395	NBC-MS/ 5,0-94B/R4RC SCO	1407428	401	NBC-MSD/10,0-93E/R4QC SCO	1407375	399	NBC-R4AC/2,0-93B/R4AC	1408969	396
NBC-M8MRD/1,0-93C/M8MRD	1080532	395	NBC-MS/10,0-94B SCO	1407407	401	NBC-MSD/10,0-93E/R4RC SCO	1407371	399	NBC-R4AC/2,0-93E/R4AC	1408934	398
NBC-M8MRD/2,0-93C/R4AC	1080543	395	NBC-MS/10,0-94B/FS SCO	1407466	401	NBC-MSX SCO-10G/././...	1408648	403	NBC-R4AC/2,0-94B/R4AC	1408951	400
NBC-M8MRD/10,0-93C	1080531	395	NBC-MS/10,0-94B/MS SCO	1407438	401	NBC-MSX-MSX SCO-10G/././...	1408644	403	NBC-R4AC/2,0-94Z/R4AC	1403929	386
NBC-M8MRD/10,0-93C/M8MRD	1080537	395	NBC-MS/10,0-94B/R4AC SCO	1407417	401	NBC-MSX-R4AC SCO-10G/././...	1408647	403	NBC-R4AC/20,0-94Z/R4AC	1423033	386
NBC-M8MRD/10,0-93C/R4AC	1080546	395	NBC-MS/10,0-94B/R4MC SCO	1407425	401	NBC-MSX-R4QC SCO-10G/././...	1408645	403	NBC-R4AC/3,0-94Z/R4AC	1403930	386
NBC-M8MRD/2,0-93C	1080528	395	NBC-MS/10,0-94B/R4QC SCO	1407433	401	NBC-MSX-R4RC SCO-10G/././...	1408646	403	NBC-R4AC/5,0-93B/R4AC	1408970	396
NBC-M8MRD/2,0-93C/M8MRD	1080535	395	NBC-MS/10,0-94B/R4RC SCO	1407429	401	NBC-MSX/ 1,0-94F SCO	1407467	403	NBC-R4AC/5,0-93E/R4AC	1408935	398
NBC-M8MRD/2,0-93C/R4AC	1080544	395	NBC-MSD SCO-PN/././...	1408640	397	NBC-MSX/ 1,0-94F/MSX SCO	1407483	403	NBC-R4AC/5,0-94B/R4AC	1408952	400
NBC-M8MRD/5,0-93C	1080530	395	NBC-MSD SCO/././...	1408713	399	NBC-MSX/ 1,0-94F/R4AC SCO	1407471	403	NBC-R4AC/5,0-94Z/R4AC	1403933	386
NBC-M8MRD/5,0-93C/M8MRD	1080536	395	NBC-MSD-FRD SCO-PN/././...	1408608	397	NBC-MSX/ 1,0-94F/R4QC SCO	1407479	403	NBC-R4AC/10,3-94G/R4AC1-BU	1413158	387
NBC-M8MRD/5,0-93C/R4AC	1080545	395	NBC-MSD-FRD SCO/././...	1408684	399	NBC-MSX/ 1,0-94F/R4RC SCO	1407475	403	NBC-R4AC/10,3-94G/R4AC1-RD	1421138	387
NBC-M8MSD/1,0-93C	1423703	395	NBC-MSD-FSD SCO-PN/././...	1408617	397	NBC-MSX/ 2,0-94F SCO	1407468	403	NBC-R4AC/10,3-94G/R4AC1-YE	1421168	387
NBC-M8MSD/1,0-93C/M8MSD	1423707	395	NBC-MSD-FSD SCO/././...	1408692	399	NBC-MSX/ 2,0-94F/MSX SCO	1407484	403	NBC-R4AC/10,5-94G/R4AC1-BU	1413159	387
NBC-M8MSD/1,0-93C/R4AC	1423711	395	NBC-MSD-MRD SCO-PN/././...	1408625	397	NBC-MSX/ 2,0-94F/R4AC SCO	1407472	403	NBC-R4AC/10,5-94G/R4AC1-RD	1421139	387
NBC-M8MSD/2,0-93C	1423704	395	NBC-MSD-MRD SCO/././...	1408700	399	NBC-MSX/ 2,0-94F/R4QC SCO	1407480	403	NBC-R4AC/10,5-94G/R4AC1-YE	1421169	387
NBC-M8MSD/2,0-93C/M8MSD	1423708	395	NBC-MSD-MSD SCO-PN/././...	1408634	397	NBC-MSX/ 2,0-94F/R4RC SCO	1407476	403	NBC-R4AC/11,0-94G/R4AC1-BU	1413160	387
NBC-M8MSD/2,0-93C/R4AC	1423712	395	NBC-MSD-MSD SCO/././...	1408706	399	NBC-MSX/ 2,0-94S SCO RAIL	1415599	404	NBC-R4AC/11,0-94G/R4AC1-RD	1421140	387
NBC-M8MSD/5,0-93C	1423705	395	NBC-MSD-R4AC SCO-PN/././...	1408639	397	NBC-MSX/ 2,0-94S/MSX SCO RAIL	1415595	404	NBC-R4AC/11,0-94G/R4AC1-YE	1421170	387
NBC-M8MSD/5,0-93C/M8MSD	1423709	395	NBC-MSD-R4AC SCO/././...	1408712	399	NBC-MSX/ 5,0-94F SCO	1407469	403	NBC-R4AC/11,0-94G/R4AC1-BU	1413164	387
NBC-M8MSD/5,0-93C/R4AC	1423713	395	NBC-MSD-R4ACR SCO-PN/././...	1408638	397	NBC-MSX/ 5,0-94F/MSX SCO	1407485	403	NBC-R4AC/110,0-94G/R4AC1-RD	1421145	387
NBC-M8MSD/10,0-93C/M8MRD	1080538	395	NBC-MSD-R4MC SCO/././...	1408710	399	NBC-MSX/ 5,0-94F/R4AC SCO	1407473	403	NBC-R4AC/110,0-94G/R4AC1-YE	1421174	387
NBC-M8MSD/10,0-93C	1423706	395	NBC-MSD-R4QC SCO-PN/././...	1408635	397	NBC-MSX/ 5,0-94F/R4QC SCO	1407481	403	NBC-R4AC/115,0-94G/R4AC1-BU	1413165	387
NBC-M8MSD/10,0-93C/M8MRD	1080542	395	NBC-MSD-R4QC SCO/././...	1408707	399	NBC-MSX/ 5,0-94F/R4RC SCO	1407477	403	NBC-R4AC/115,0-94G/R4AC1-RD	1421146	387
NBC-M8MSD/10,0-93C/M8MSD	1423710	395	NBC-MSD-R4RC SCO-PN/././...	1408636	397	NBC-MSX/ 5,0-94S SCO RAIL	1415600	404	NBC-R4AC/115,0-94G/R4AC1-YE	1421175	387
NBC-M8MSD/10,0-93C/R4AC	1423714	395	NBC-MSD-R4RC SCO/././...	1408709	399	NBC-MSX/ 5,0-94S/MSX SCO RAIL	1415598	404	NBC-R4AC/120,0-94G/R4AC1-BU	1413161	387
NBC-M8MSD/2,0-93C/M8MRD	1080539	395	NBC-MSD/ 1,0-93B SCO	1407495	397	NBC-MSX/ 10,0-94F SCO	1407470	403	NBC-R4AC/120,0-94G/R4AC1-RD	1421141	387
NBC-M8MSD/5,0-93C/M8MRD	1080540	395	NBC-MSD/ 1,0-93B/FSD SCO	1407553	397	NBC-MSX/ 10,0-94F/MSX SCO	1407486	403	NBC-R4AC/120,0-94G/R4AC1-YE	1421171	387
NBC-MR SCO-IE/././...	1408675	401	NBC-MSD/ 1,0-93B/MSD SCO	1407524	397	NBC-MSX/10,0-94F/R4AC SCO	1407474	403	NBC-R4AC/120,0-94G/R4AC1-BU	1413166	387
NBC-MR-FR SCO-IE/././...	1408649	401	NBC-MSD/ 1,0-93B/R4AC SCO	1407499	397	NBC-MSX/10,0-94F/R4QC SCO	1407482	403	NBC-R4AC/120,0-94G/R4AC1-RD	1421147	387
NBC-MR-FS SCO-IE/././...	1408658	401	NBC-MSD/ 1,0-93B/R4RC SCO	1407508	397	NBC-MSX/10,0-94F/R4RC SCO	1407478	403	NBC-R4AC/120,0-94G/R4AC1-YE	1421176	387
NBC-MR-MR SCO-IE/././...	1408666	401	NBC-MSD/ 1,0-93B/R4QC SCO	1407520	397	NBC-MSX/10,0-94S SCO RAIL	1415601	404	NBC-R4AC/120,0-94G/R4AC1-BU	1413162	387
NBC-MR-R4AC SCO-IE/././...	1408674	401	NBC-MSD/ 1,0-93B/R4RC SCO	1407516	397	NBC-MSY SCO-EH/././...	1408642	405	NBC-R4AC/120,0-94G/R4AC1-RD	1421143	387
NBC-MR-R4MC SCO-IE/././...	1408671	401	NBC-MSD/ 1,0-93E SCO	1407356	399	NBC-MSY-MSY SCO-EH/././...	1408641	405	NBC-R4AC/13,0-94G/R4AC1-YE	1421172	387
NBC-MR-R4QC SCO-IE/././...	1408668	401	NBC-MSD/ 1,0-93E/FSD SCO	1407400	399	NBC-MSY/ 1,0-94H SCO	1407487	405	NBC-R4AC/13,0-94G/R4AC1-BU	1413163	387
NBC-MR-R4RC SCO-IE/././...	1408670	401	NBC-MSD/ 1,0-93E/MSD SCO	1407376	399	NBC-MSY/ 1,0-94H/MSY SCO	1407491	405	NBC-R4AC/15,0-94G/R4AC1-RD	1421144	387
NBC-MRD SCO-PN/././...	1408633	397	NBC-MSD/ 1,0-93E/R4AC SCO	1407360	399	NBC-MSY/ 2,0-94H SCO	1407488	405	NBC-R4AC/15,0-94G/R4AC1-YE	1421173	387
NBC-MRD SCO/././...	1408705	399	NBC-MSD/ 1,0-93E/R4MC SCO	1407364	399	NBC-MSY/ 2,0-94H/MSY SCO	1407492	405	NBC-R4ACR-PN4/././...	1411858	396
NBC-MRD-FRD SCO-PN/././...	1408607	397	NBC-MSD/ 1,0-93E/R4QC SCO	1407372	399	NBC-MSY/ 5,0-94H SCO	1407489	405	NBC-R4ACR-R4ACR-PN4/././...	1411865	396
NBC-MRD-FRD SCO/././...	1408683	399	NBC-MSD/ 1,0-93E/R4RC SCO	1407368	399	NBC-MSY/ 10,0-94H/MSY SCO	1407493	405	NBC-R4ACR/1,0-93B/R4ACR	1409002	396
NBC-MRD-FSD SCO-PN/././...	1408616	397	NBC-MSD/ 2,0-93B SCO	1407496	397	NBC-MSY/10,0-94H SCO	1407490	405	NBC-R4ACR/10,0-93B/R4ACR	1409005	396
NBC-MRD-FSD SCO/././...	1408691	399	NBC-MSD/ 2,0-93B/FSD SCO	1407554	397	NBC-MSY/10,0-94H/MSY SCO	1407494	405	NBC-R4ACR/2,0-93B/R4ACR	1409003	396
NBC-MRD-MRD SCO-PN/././...	1408624	397	NBC-MSD/ 2,0-93B/MSD SCO	1407525	397	NBC-PP-A1PRD:10	1041900	375	NBC-R4ACR/5,0-93B/R4ACR	1409004	396
NBC-MRD-MRD SCO/././...	1408699	399	NBC-MSD/ 2,0-93B/R4AC SCO	1407500	397	NBC-PP-F1PWH:10	1041881	375	NBC-R4MC-IE4/././...	1411828	398
NBC-MRD-R4AC SCO-PN/././...	1408632	397	NBC-MSD/ 2,0-93B/R4ACR SCO	1407509	397	NBC-PP-G1PGY	1041740	375	NBC-R4MC-IE8/././...	1411839	400
NBC-MRD-R4AC SCO/././...	1408704	399	NBC-MSD/ 2,0-93B/R4QC SCO	1407521	397	NBC-PP-P1PGY:10	1041860	375	NBC-R4MC-IE8A/././...	1415639	402
NBC-MRD-R4ACR SCO-PN/././...	1408631	397	NBC-MSD/ 2,0-93B/R4RC SCO	1407517	397	NBC-R4AC-IE4/././...	1411827	398	NBC-R4MC-R4MC-IE4/././...	1411835	398
NBC-MRD-R4MC SCO/././...	1408703	399	NBC-MSD/ 2,0-93E SCO	1407357	399	NBC-R4AC-IE8/././...	1411838	400	NBC-R4MC-R4MC-IE8/././...	1411846	400
NBC-MRD-R4QC SCO-PN/././...	1408626	397	NBC-								

Index

Alphabetical

Type	Order No.	Page	Type	Order No.	Page	Type	Order No.	Page	Type	Order No.	Page
NBC-R4QC-R4QC-IE4/...	1411837	399	PSM-SET-FSMA-LINK/2	2799416	380	QPD N 4PE1,5 9-14 BK	1415104	472	QPD W 4PE1,5 M25 1,0 BK	1414737	477
NBC-R4QC-R4QC-IE8/...	1411848	401	PSM-SET-FSMA/4-HCS	2799487	376	QPD N 4PE2,5 6-11 BK	1459663	481	QPD W 4PE1,5 M25 FC BK	1414738	478
NBC-R4QC-R4QC-IE8A/...	1414324	403	PSM-SET-FSMA/4-KT	2799720	376	QPD N 4PE2,5 9-16 BK	1459647	481	QPD W 4PE2,5 6-11 M25 0,5 BK	1403725	484
NBC-R4QC-R4QC-PN4/...	1411867	397	PSM-SET-SC-DUPLEX/2-HCS/PN	2313779	377	QPD N 4PE6,0 12-20 BK	1410406	489	QPD W 4PE2,5 6-11 M20 1,0 BK	1403727	484
NBC-R4QC/1,0-93B/R4QC	1408978	397	PT/FS 4,8	1670497	480	QPD N 4PE6,0 9-14 BK	1410409	489	QPD W 4PE2,5 6-11 M20 FC BK	1403729	485
NBC-R4QC/1,0-93E/R4QC	1408947	399				QPD N2,5 6-10 BK	1423993	481	QPD W 4PE2,5 6-11 M25 0,5 BK	1582557	484
NBC-R4QC/1,0-94B/R4QC	1408965	401				QPD N2,5 9-14 BK	1423994	481	QPD W 4PE2,5 6-11 M25 1,0 BK	1582558	484
NBC-R4QC/10,0-93B/R4QC	1408980	397				QPD P 2PE1,5 4-9 BK	1414705	479	QPD W 4PE2,5 6-11 M25 DT BK	1411432	486
NBC-R4QC/10,0-93E/R4QC	1408949	399				QPD P 2PE1,5 8-13 BK	1414706	479	QPD W 4PE2,5 6-11 M25 FC BK	1582559	485
NBC-R4QC/10,0-94B/R4QC	1408967	401				QPD P 3PE1,5 4-9 BK	1414703	479	QPD W 4PE2,5 9-16 M20 0,5 BK	1403731	484
NBC-R4QC/2,0-93B/R4QC	1408979	397				QPD P 3PE1,5 8-13 BK	1414704	479	QPD W 4PE2,5 9-16 M20 1,0 BK	1403733	484
NBC-R4QC/2,0-93E/R4QC	1408948	399				QPD P 4PE1,5 5-10 BK	1414749	479	QPD W 4PE2,5 9-16 M20 FC BK	1403735	485
NBC-R4QC/2,0-94B/R4QC	1408966	401				QPD P 4PE1,5 9-14 BK	1414750	479	QPD W 4PE2,5 9-16 M25 0,5 BK	1582561	484
NBC-R4QC/5,0-93B/R4QC	1408977	397				QPD P 4PE2,5 6-11 TL BK	1039563	487	QPD W 4PE2,5 9-16 M25 1,0 BK	1582562	484
NBC-R4QC/5,0-93E/R4QC	1408946	399				QPD P 4PE2,5 9-16 TL BK	1039561	487	QPD W 4PE2,5 9-16 M25 DT BK	1411433	486
NBC-R4QC/5,0-94B/R4QC	1408964	401				QPD P 4PE6,0 12-20 TL BK	1039565	493	QPD W 4PE2,5 9-16 M25 FC BK	1582563	485
NBC-R4RC-IE4/...	1411829	398				QPD P 4PE6,0 9-14 TL BK	1039564	493	QPD W 4PE2,5 M20 0,5 BK	1403737	484
NBC-R4RC-IE8/...	1411840	400				QPD P 3PE1,5 4-9 BK	1414724	480	QPD W 4PE2,5 M20 1,0 BK	1403739	484
NBC-R4RC-IE8A/...	1415637	402				QPD P 3PE1,5 8-13 BK	1414759	480	QPD W 4PE2,5 M20 FC BK	1403741	485
NBC-R4RC-PN4/...	1411859	396				QPD P 3PE1,5 5-10 BK	1404529	488	QPD W 4PE2,5 M25 0,5 BK	1582565	484
NBC-R4RC-R4RC-IE4/...	1411836	398				QPD P 4PE6,0 9-14 TL BK	1039564	493	QPD W 4PE2,5 M20 0,5 BK	1403737	484
NBC-R4RC-R4RC-IE8/...	1411847	400				QPD P 3PE1,5 4-9 BK	1414724	480	QPD W 4PE2,5 M20 1,0 BK	1582567	484
NBC-R4RC-R4RC-IE8A/...	1414323	402				QPD P 3PE1,5 8-13 BK	1414759	480	QPD W 4PE2,5 M20 FC BK	1403741	485
NBC-R4RC-R4RC-PN4/...	1411866	396				QPD P 3PE1,5 5-10 BK	1404529	488	QPD W 4PE2,5 M25 0,5 BK	1582565	484
NBC-R4RC/1,0-93B/R4RC	1408974	396				QPD P 4PE6,0 9-14 TL BK	1039564	493	QPD W 4PE2,5 M20 0,5 BK	1403737	484
NBC-R4RC/1,0-93E/R4RC	1408941	398				QPD P 3PE1,5 4-9 BK	1414724	480	QPD W 4PE2,5 M20 1,0 BK	1582567	484
NBC-R4RC/1,0-94B/R4RC	1408961	400				QPD P 3PE1,5 8-13 BK	1414759	480	QPD W 4PE2,5 M20 FC BK	1403741	485
NBC-R4RC/10,0-93B/R4RC	1408976	396				QPD P 3PE1,5 5-10 BK	1404529	488	QPD W 4PE2,5 M25 0,5 BK	1582565	484
NBC-R4RC/10,0-93E/R4RC	1408945	398				QPD P 4PE6,0 9-14 TL BK	1039564	493	QPD W 4PE2,5 M20 0,5 BK	1403737	484
NBC-R4RC/10,0-94B/R4RC	1408963	400				QPD P 3PE1,5 4-9 BK	1414724	480	QPD W 4PE2,5 M20 1,0 BK	1582567	484
NBC-R4RC/2,0-93B/R4RC	1408975	396				QPD P 3PE1,5 8-13 BK	1414759	480	QPD W 4PE2,5 M20 FC BK	1403741	485
NBC-R4RC/2,0-93E/R4RC	1408942	398				QPD P 3PE1,5 5-10 BK	1404529	488	QPD W 4PE2,5 M25 0,5 BK	1582565	484
NBC-R4RC/2,0-94B/R4RC	1408962	400				QPD P 4PE6,0 9-14 TL BK	1039564	493	QPD W 4PE2,5 M20 0,5 BK	1403737	484
NBC-R4RC/5,0-93B/R4RC	1408972	396				QPD P 3PE1,5 4-9 BK	1414724	480	QPD W 4PE2,5 M20 1,0 BK	1582567	484
NBC-R4RC/5,0-93E/R4RC	1408943	398				QPD P 3PE1,5 8-13 BK	1414759	480	QPD W 4PE2,5 M20 FC BK	1403741	485
NBC-R4RC/5,0-94B/R4RC	1408959	400				QPD P 3PE1,5 5-10 BK	1404529	488	QPD W 4PE2,5 M25 0,5 BK	1582565	484
						QPD P 4PE6,0 9-14 TL BK	1039564	493	QPD W 4PE2,5 M20 0,5 BK	1403737	484
						QPD P 3PE1,5 4-9 BK	1414724	480	QPD W 4PE2,5 M20 1,0 BK	1582567	484
						QPD P 3PE1,5 8-13 BK	1414759	480	QPD W 4PE2,5 M20 FC BK	1403741	485
						QPD P 3PE1,5 5-10 BK	1404529	488	QPD W 4PE2,5 M25 0,5 BK	1582565	484
						QPD P 4PE6,0 9-14 TL BK	1039564	493	QPD W 4PE2,5 M20 0,5 BK	1403737	484
						QPD P 3PE1,5 4-9 BK	1414724	480	QPD W 4PE2,5 M20 1,0 BK	1582567	484
						QPD P 3PE1,5 8-13 BK	1414759	480	QPD W 4PE2,5 M20 FC BK	1403741	485
						QPD P 3PE1,5 5-10 BK	1404529	488	QPD W 4PE2,5 M25 0,5 BK	1582565	484
						QPD P 4PE6,0 9-14 TL BK	1039564	493	QPD W 4PE2,5 M20 0,5 BK	1403737	484
						QPD P 3PE1,5 4-9 BK	1414724	480	QPD W 4PE2,5 M20 1,0 BK	1582567	484
						QPD P 3PE1,5 8-13 BK	1414759	480	QPD W 4PE2,5 M20 FC BK	1403741	485
						QPD P 3PE1,5 5-10 BK	1404529	488	QPD W 4PE2,5 M25 0,5 BK	1582565	484
						QPD P 4PE6,0 9-14 TL BK	1039564	493	QPD W 4PE2,5 M20 0,5 BK	1403737	484
						QPD P 3PE1,5 4-9 BK	1414724	480	QPD W 4PE2,5 M20 1,0 BK	1582567	484
						QPD P 3PE1,5 8-13 BK	1414759	480	QPD W 4PE2,5 M20 FC BK	1403741	485
						QPD P 3PE1,5 5-10 BK	1404529	488	QPD W 4PE2,5 M25 0,5 BK	1582565	484
						QPD P 4PE6,0 9-14 TL BK	1039564	493	QPD W 4PE2,5 M20 0,5 BK	1403737	484
						QPD P 3PE1,5 4-9 BK	1414724	480	QPD W 4PE2,5 M20 1,0 BK	1582567	484
						QPD P 3PE1,5 8-13 BK	1414759	480	QPD W 4PE2,5 M20 FC BK	1403741	485
						QPD P 3PE1,5 5-10 BK	1404529	488	QPD W 4PE2,5 M25 0,5 BK	1582565	484
						QPD P 4PE6,0 9-14 TL BK	1039564	493	QPD W 4PE2,5 M20 0,5 BK	1403737	484
						QPD P 3PE1,5 4-9 BK	1414724	480	QPD W 4PE2,5 M20 1,0 BK	1582567	484
						QPD P 3PE1,5 8-13 BK	1414759	480	QPD W 4PE2,5 M20 FC BK	1403741	485
						QPD P 3PE1,5 5-10 BK	1404529	488	QPD W 4PE2,5 M25 0,5 BK	1582565	484
						QPD P 4PE6,0 9-14 TL BK	1039564	493	QPD W 4PE2,5 M20 0,5 BK	1403737	484
						QPD P 3PE1,5 4-9 BK	1414724	480	QPD W 4PE2,5 M20 1,0 BK	1582567	484
						QPD P 3PE1,5 8-13 BK	1414759	480	QPD W 4PE2,5 M20 FC BK	1403741	485
						QPD P 3PE1,5 5-10 BK	1404529	488	QPD W 4PE2,5 M25 0,5 BK	1582565	484
						QPD P 4PE6,0 9-14 TL BK	1039564	493	QPD W 4PE2,5 M20 0,5 BK	1403737	484
						QPD P 3PE1,5 4-9 BK	1414724	480	QPD W 4PE2,5 M20 1,0 BK	1582567	484
						QPD P 3PE1,5 8-13 BK	1414759	480	QPD W 4PE2,5 M20 FC BK	1403741	485
						QPD P 3PE1,5 5-10 BK	1404529	488	QPD W 4PE2,5 M25 0,5 BK	1582565	484
						QPD P 4PE6,0 9-14 TL BK	1039564	493	QPD W 4PE2,5 M20 0,5 BK	1403737	484
						QPD P 3PE1,5 4-9 BK	1414724	480	QPD W 4PE2,5 M20 1,0 BK	1582567	484
						QPD P 3PE1,5 8-13 BK	1414759	480	QPD W 4PE2,5 M20 FC BK	1403741	485
						QPD P 3PE1,5 5-10 BK	1404529	488	QPD W 4PE2,5 M25 0,5 BK	1582565	484
						QPD P 4PE6,0 9-14 TL BK	1039564	493	QPD W 4PE2,5 M20 0,5 BK	1403737	484
						QPD P 3PE1,5 4-9 BK	1414724	480	QPD W 4PE2,5 M20 1,0 BK	1582567	484
						QPD P 3PE1,5 8-13 BK	1414759	480	QPD W 4PE2,5 M20 FC BK	1403741	485
						QPD P 3PE1,5 5-10 BK	1404529	488	QPD W 4PE2,5 M25 0,5 BK	1582565	484
						QPD P 4PE6,0 9-14 TL BK	1039564	493	QPD W 4PE2,5 M20 0,5 BK	1403737	484
						QPD P 3PE1,5 4-9 BK	1414724	480	QPD W 4PE2,5 M20 1,0 BK	1582567	484
						QPD P 3PE1,5 8-13 BK	1414759	480	QPD W 4PE2,5 M20 FC BK	1403741	485
						QPD P 3PE1,5 5-10 BK	1404529	488	QPD W 4PE2,5 M25 0,5 BK	1582565	484
						QPD P 4PE6,0 9-14 TL BK	1039564	493	QPD W 4PE2,5 M20 0,5 BK	1403737	484
						QPD P 3PE1,5 4-9 BK	1414724	480	QPD W 4PE2,5 M20 1,0 BK	1582567	484
						QPD P 3PE1,5 8-13 BK	1414759	480	QPD W 4PE2,5 M20 FC BK	1403741	485
						QPD P 3PE1,5 5-10 BK	1404529	488	QPD W 4PE2,5 M25 0,5 BK	1582565	484
						QPD P 4PE6,0 9-14 TL BK	1039564	493	QPD W 4PE2,5 M20 0,5 BK	1403737	484
						QPD P 3PE1,5 4-9 BK	1414724	480	QPD W 4PE2,5 M20 1,0 BK	1582567	484
						QPD P 3PE1,5 8-13 BK	1414759	480	QPD W 4PE2,5 M20 FC BK	1403741	485
						QPD P 3PE1,5 5-10 BK	1404529	488	QPD W 4PE2,5 M25 0,5 BK	1582565	484
						QPD P 4PE6,0 9-14 TL BK	1039564	493	QPD W 4PE2,5 M20 0,5 BK		

Type	Order No.	Page	Type	Order No.	Page	Type	Order No.	Page	Type	Order No.	Page
RC-Z2490	1611803	176	SAC-3,0/0,2-116/2XB1-1L-Z	1458431	243	SAC-17P-1,5-PUR/FR SCO	1430815	212	SAC-2P-M12FSB/910/...	1538063	429
RC-Z2494	1614123	176	SAC-5,0/0,1-116/2XA-1L-Z	1458004	243	SAC-17P-1,5-PUR/FS SCO	1430776	212	SAC-2P-M12MSB-M12FSB/910/...	1538089	429
RC-Z2514	1614590	176	SAC-5,0/0,1-116/2XB-1L-Z	1458185	243	SAC-17P-1,5-PVC/FR SCO	1555389	213	SAC-2P-M12MSB/0,3-910/M12FSB	1507340	429
RC/TGGM/KVD/LBL 16+3	1685505	314	SAC-5,0/0,1-116/2XB1-1L-Z	1458363	243	SAC-17P-1,5-PVC/FS SCO	1555347	213	SAC-2P-M12MSB/0,5-910/M12FSB	1507353	429
RC/TWGM/KVD/LBL 16+3	1685518	314	SAC-5,0/0,15-116/2XA-1L-Z	1458046	243	SAC-17P-3,0-35T/FR SH SCO	1430336	215	SAC-2P-M12MSB/1,0-910/M12FSB	1507366	429
RCK-TWGM/BL16+3/5,0PUR SH	1519529	314	SAC-5,0/0,15-116/2XB-1L-Z	1458224	243	SAC-17P-3,0-35T/FS SH SCO	1430297	215	SAC-2P-M12MSB/2,0-910	1507243	429
RCK-TWGM/BL16+3/10,0PUR SH	1511828	314	SAC-5,0/0,15-116/2XB1-1L-Z	1458402	243	SAC-17P-3,0-PUR/FR SCO	1430828	212	SAC-2P-M12MSB/0,3-910/M12FSB	1507379	429
REDUC-K-KV-M25/M20 BK	1411232	700	SAC-5,0/0,2-116/2XA-1L-Z	1458088	243	SAC-17P-3,0-PUR/FS SCO	1430789	212	SAC-2P-M12MSB/5,0-910	1507256	429
REDUC-K-KV-M32/M20 BK	1410725	700	SAC-5,0/0,2-116/2XB-1L-Z	1458266	243	SAC-17P-3,0-PVC/FR SCO	1555392	213	SAC-2P-M12MSB/5,0-910/M12FSB	1507382	429
REDUC-K-KV-M32/M25 BK	1410712	700	SAC-5,0/0,2-116/2XB1-1L-Z	1458444	243	SAC-17P-3,0-PVC/FS SCO	1555350	213	SAC-2P-M12MSB/10,0-910	1507269	429
REDUC-K-KV-M40/M25 BK	1410741	700	SAC-10,0/0,1-116/2XA-1L-Z	1458017	243	SAC-17P-5,0-35T/FR SH SCO	1430349	215	SAC-2P-M12MSB/10,0-910/M12FSB	1507395	429
REDUC-K-KV-M40/M32 BK	1410738	700	SAC-10,0/0,1-116/2XB-1L-Z	1458198	243	SAC-17P-5,0-35T/FS SH SCO	1430307	215	SAC-2P-M12MSB/15,0-910	1507272	429
REDUC-M-KV-M20/M16	1647611	700	SAC-10,0/0,1-116/2XB1-1L-Z	1458376	243	SAC-17P-5,0-PUR/FR SCO	1430831	212	SAC-2P-M12MSB/15,0-910/M12FSB	1507405	429
REDUC-M-KV-M25/M20	1647624	700	SAC-10,0/0,15-116/2XA-1L-Z	1458095	243	SAC-17P-5,0-PVC/FS SCO	1430792	212	SAC-2P-M12MSB/910/...	1538047	429
REDUC-M-KV-M32/M25	1647637	700	SAC-10,0/0,15-116/2XB-1L-Z	1458237	243	SAC-17P-5,0-PVC/FR SCO	1555402	213	SAC-2P-SUSMS/0,3-PUR/SUSFS	1410757	247
REDUC-M-KV-M40/M32	1647640	700	SAC-10,0/0,15-116/2XB1-1L-Z	1458415	243	SAC-17P-5,0-PVC/FS SCO	1555363	213	SAC-2P-SUSMS/0,6-PUR/SUSFS	1410759	247
RF-12P1N8AAC00	1607802	112	SAC-10,0/0,2-116/2XA-1L-Z	1458091	243	SAC-17P-10,0-35T/FR SH SCO	1430352	215	SAC-2P-SUSMS/1,5-PUR	1410752	247
RF-12P1N8AAD00	1607233	112	SAC-10,0/0,2-116/2XB-1L-Z	1458279	243	SAC-17P-10,0-35T/FS SH SCO	1430310	215	SAC-2P-SUSMS/1,5-PUR/SUSFS	1410760	247
RF-12P1N8AWA00	1607236	112	SAC-10,0/0,2-116/2XB1-1L-Z	1458457	243	SAC-17P-10,0-PUR/FR SCO	1430844	212	SAC-2P-SUSMS/3,0-PUR	1410753	247
RF-12P1N8AWB00	1607804	112	SAC-10P-5,0-PUR/M16FR	1693704	311	SAC-17P-10,0-PUR/FS SCO	1430802	212	SAC-2P-SUSMS/3,0-PUR/SUSFS	1410761	247
RF-12P2N8AAC00	1607814	112	SAC-10P-10,0-PUR/M16FR	1693717	311	SAC-17P-10,0-PVC/FR SCO	1555415	213	SAC-2P-SUSMS/5,0-PUR	1410755	247
RF-12P2N8AAD00	1607257	112	SAC-12P-0,5-35T/FS SH SCO	1437083	214	SAC-17P-10,0-PVC/FS SCO	1555376	213	SAC-2P-SUSMS/10,0-PUR	1410756	247
RF-12P2N8AWA00	1607260	112	SAC-12P-1,0-35T/FS SH SCO	1434730	214	SAC-17P-100,0-PVC/0,14	1441545	302	SAC-3P-1,0-PVC/M12FSS PE	1411648	288
RF-12P2N8AWB00	1607817	112	SAC-12P-1,5-35T/FR SH SCO	1430161	214	SAC-17P-MR/1,5-35T SH SCO	1430242	215	SAC-3P-1,0-PVC/M12FSS PE	1411644	288
RF-12S1N8AAC00	1607827	112	SAC-12P-1,5-35T/FS SH SCO	1430129	214	SAC-17P-MR/1,5-PUR SCO	1430734	212	SAC-3P-1,5-800/M12FR	1454260	192
RF-12S1N8AAD00	1607280	112	SAC-12P-1,5-PUR/FR SCO	1430653	212	SAC-17P-MR/1,5-PVC SCO	1555305	213	SAC-3P-1,5-800/M12FR-2L	1454312	192
RF-12S1N8AWA00	1607283	112	SAC-12P-1,5-PUR/FS SCO	1430611	212	SAC-17P-MR/3,0-35T SH SCO	1430255	215	SAC-3P-1,5-800/M12FS	1456679	192
RF-12S1N8AWB00	1607830	112	SAC-12P-1,5-PVC/FR SCO	1554898	213	SAC-17P-MR/3,0-PUR SCO	1430747	212	SAC-3P-1,5-PUR/A	1402983	230
RF-12S2N8AAC00	1607842	112	SAC-12P-1,5-PVC/FS SCO	1554856	213	SAC-17P-MR/3,0-PVC SCO	1555318	213	SAC-3P-1,5-PUR/A-1L-R-ES	1413115	234
RF-12S2N8AAD00	1607304	112	SAC-12P-3,0-35T/FR SH SCO	1430174	214	SAC-17P-MR/5,0-35T SH SCO	1430268	215	SAC-3P-1,5-PUR/A-1L-R-ES 4A	1400827	235
RF-12S2N8AWA00	1607307	112	SAC-12P-3,0-35T/FS SH SCO	1430132	214	SAC-17P-MR/5,0-PUR SCO	1430750	212	SAC-3P-1,5-PUR/A-1L-V	1443103	230
RF-12S2N8AWB00	1607844	112	SAC-12P-3,0-PUR/FR SCO	1430666	212	SAC-17P-MR/5,0-PVC SCO	1555321	213	SAC-3P-1,5-PUR/A-1L-V 230V	1402985	232
RF-17P1N8AAC00	1607852	112	SAC-12P-3,0-PUR/FS SCO	1430624	212	SAC-17P-MR/10,0-35T SH SCO	1430271	215	SAC-3P-1,5-PUR/A-1L-Z	1434989	228
RF-17P1N8AAD00	1607328	112	SAC-12P-3,0-PVC/FR SCO	1554908	213	SAC-17P-MR/10,0-PUR SCO	1430763	212	SAC-3P-1,5-PUR/B-1L-R-ES	1401294	234
RF-17P1N8AWA00	1607860	112	SAC-12P-3,0-PVC/FS SCO	1554869	213	SAC-17P-MR/10,0-PVC SCO	1555334	213	SAC-3P-1,5-PUR/B-1L-V	1443145	230
RF-17P1N8AWB00	1607863	112	SAC-12P-5,0-35T/FR SH SCO	1430187	214	SAC-17P-MR/10,0-35T SH SCO	1430200	215	SAC-3P-1,5-PUR/B-1L-Z	1435386	228
RF-17S1N8AAC00	1607887	112	SAC-12P-5,0-35T/FS SH SCO	1430145	214	SAC-17P-MS/1,5-PUR SCO	1430695	212	SAC-3P-1,5-PUR/BI-1L-R-ES	1401340	234
RF-17S1N8AAD00	1607345	112	SAC-12P-5,0-PUR/FR SCO	1430679	212	SAC-17P-MS/1,5-PVC SCO	1555266	213	SAC-3P-1,5-PUR/BI-1L-V	1443187	230
RF-17S1N8AWA00	1607892	112	SAC-12P-5,0-PUR/FS SCO	1430637	212	SAC-17P-MS/3,0-35T SH SCO	1430213	215	SAC-3P-1,5-PUR/BI-1L-Z	1435234	228
RF-17S1N8AWB00	1607893	112	SAC-12P-5,0-PUR/M16FR	1693720	311	SAC-17P-MS/3,0-PUR SCO	1430705	212	SAC-3P-1,5-PUR/CI-1L-R-ES	1401434	234
RF-Z0001	1607904	179	SAC-12P-5,0-PVC/FR SCO	1554924	213	SAC-17P-MS/3,0-PVC SCO	1555279	213	SAC-3P-1,5-PUR/CI-1L-V	1443226	230
RF-Z0003	1607905	179	SAC-12P-5,0-PVC/FS SCO	1554872	213	SAC-17P-MS/5,0-35T SH SCO	1430226	215	SAC-3P-1,5-PUR/CI-1L-Z	1435535	228
RF-Z0007	1614347	176	SAC-12P-10,0-35T/FR SH SCO	1430190	214	SAC-17P-MS/5,0-PUR SCO	1430718	212	SAC-3P-1,5-PUR/CI-1L-R-ES	1401466	234
RF-Z0014	1620588	180	SAC-12P-10,0-35T/FS SH SCO	1430158	214	SAC-17P-MS/5,0-PVC SCO	1555282	213	SAC-3P-1,5-PUR/CI-1L-V	1443268	230
RF-Z0015	1620592	180	SAC-12P-10,0-PUR/FR SCO	1430682	212	SAC-17P-MS/10,0-35T SH SCO	1430239	215	SAC-3P-1,5-PUR/CI-1L-Z	1435687	228
RF-Z0016	1620593	180	SAC-12P-10,0-PUR/FS SCO	1430640	212	SAC-17P-MS/10,0-35T/FS SH SCO	1402422	212	SAC-3P-1,5-PUR/DTFS	1414995	244
RF-Z0017	1620624	180	SAC-12P-10,0-PUR/M16FR	1693733	311	SAC-17P-MS/10,0-PUR SCO	1430721	215	SAC-3P-1,5-PUR/M 8FR	1669738	188
RF-Z0018	1620625	180	SAC-12P-10,0-PVC/FR SCO	1554937	213	SAC-17P-MS/10,0-PVC SCO	1555295	213	SAC-3P-1,5-PUR/M 8FR SH	1521766	193
RF-Z0019	1620626	180	SAC-12P-10,0-PVC/FS SCO	1554885	213	SAC-17P-MS/5,0-35T/FS SH SCO	1402421	215	SAC-3P-1,5-PUR/M 8FR-2L	1671069	188
			SAC-12P-100,0-35T/SH,0,14	1405789	303	SAC-2P-1,5-PUR/DTFS	1410723	244	SAC-3P-1,5-PUR/M 8FS	1669712	188
			SAC-12P-100,0-PVC/0,14	1441532	302	SAC-2P-1,5-PUR/DTFS-1L	1410728	245	SAC-3P-1,5-PUR/M 8FS SH	1521711	193
			SAC-12P-MR/1,5-35T SH SCO	1430080	214	SAC-2P-1,5-PUR/DTFS-1L-S	1410732	246	SAC-3P-1,5-PUR/M12FR	1694509	188
			SAC-12P-MR/1,5-PUR SCO	1430572	212	SAC-2P-1,5-PUR/SUSFS	1410748	247	SAC-3P-1,5-PUR/M12FR B	1668195	188
			SAC-12P-MR/1,5-PVC SCO	1554814	213	SAC-2P-2,0-910/M12FSB	1507298	429	SAC-3P-1,5-PUR/M12FR SH	1682812	193
			SAC-12P-MR/3,0-35T SH SCO	1430093	214	SAC-2P-3,0-PUR/DTFS	1410724	244	SAC-3P-1,5-PUR/M12FR-2L	1694392	188
			SAC-12P-MR/3,0-PUR SCO	1430585	212	SAC-2P-3,0-PUR/DTFS-1L	1410729	245	SAC-3P-1,5-PUR/M12FR-2L B	1668250	188
SAC BIT HOOD-W 24	1212486	310	SAC-12P-MR/3,0-PVC SCO	1554827	213	SAC-2P-3,0-PUR/DTFS-1L-S	1410733	246	SAC-3P-1,5-PUR/M12FS	1694486	188
SAC BIT M12-D15	1208432	306	SAC-12P-MR/5,0-35T SH SCO	1430103	214	SAC-2P-3,0-PUR/SUSFS	1410749	247	SAC-3P-1,5-PUR/M12FS B	1668072	188
SAC BIT M12-D16	1200305	306	SAC-12P-MR/5,0-PUR SCO	1430598	212	SAC-2P-5,0-910/M12FSB	1507308	429	SAC-3P-1,5-PUR/M12FS SH	1682786	193
SAC BIT M12-W14	1212513	57	SAC-12P-MR/5,0-PVC SCO	1554830	213	SAC-2P-5,0-PUR/DTFS	1410726	244	SAC-3P-1,5-PUR/M12FS-2L	1694185	188
SAC BIT M8-D10	1208461	306	SAC-12P-MR/10,0-35T SH SCO	1430116	214	SAC-2P-5,0-PUR/DTFS-1L	1410730	245	SAC-3P-1,5-PVC/A	1415920	239
SAC BIT MIN-D25	1212512	57	SAC-12P-MR/10,0-PUR SCO	1430608	212	SAC-2P-5,0-PUR/DTFS-1L-S	1410734	246	SAC-3P-1,5-PVC/A-1L-V	1415908	231
SAC BIT QUICKON-W13	1212033	315	SAC-12P-MR/10,0-PVC SCO	1554843	213	SAC-2P-5,0-PUR/SUSFS	1410750	247	SAC-3P-1,5-PVC/A-1L-V 230V	1415912	233
SAC-1,5/0,1-116/2XA-1L-Z	1457982	243	SAC-12P-MS/1,5-35T SH SCO	1430048	214	SAC-2P-10,0-910/M12FSB	1507311	429	SAC-3P-1,5-PVC/A-1L-Z	1438684	229
SAC-1,5/0,1-116/2XB-1L-Z	1458169	243	SAC-12P-MS/1,5-PUR SCO	1430530	212	SAC-2P-10,0-PUR/DTFS	1410727	244	SAC-3P-1,5-PVC/B-1L-V	1415925	231
SAC-1,5/0,1-116/2XB1-1L-Z	1458347	243	SAC-12P-MS/1,5-PVC SCO	1554775	213	SAC-2P-10,0-PUR/DTFS-1L	1410731	245	SAC-3P-1,5-PVC/B-1L-Z	1415922	229
SAC-1,5/0,15-116/2XA-1L-Z	1458020	243	SAC-12P-MS/3,0-35T SH SCO	1430051	214	SAC-2P-10,0-PUR/DTFS-1L-S	1410735	246	SAC-3P-1,5-PVC/BI-1L-V	1415931	231
SAC-1,5/0,15-116/2XB-1L-Z	1458208	243	SAC-12P-MS/3,0-35T/FS SH SCO	1402551	214	SAC-2P-10,0-PUR/SUSFS	1410751	247	SAC-3P-1,5-PVC/BI-1L-Z	1415929	229
SAC-1,5/0,15-116/2XB1-1L-Z	1458389	243	SAC-12P-MS/3,0-PUR SCO	1430543	212	SAC-2P-15,0-910/M12FSB	1507324	429	SAC-3P-1,5-PVC/CI-1L-V	14159	

Index

Alphabetical

Type	Order No.	Page	Type	Order No.	Page	Type	Order No.	Page	Type	Order No.	Page
SAC-3P-2,0-961/M12FS VA	1419082	430	SAC-3P-5,0-PUR/CI-1L-V	1443284	230	SAC-3P-10,0-PUR/M12FS B	1694208	188	SAC-3P-M 8MR-M12FS/.../...	1697726	188
SAC-3P-2,0-PVC/M12FRS PE	1411649	288	SAC-3P-5,0-PUR/CI-1L-Z	1435700	228	SAC-3P-10,0-PUR/M12FS SH	1500680	193	SAC-3P-M 8MR/0,3-PUR/M 8FR	1682061	188
SAC-3P-2,0-PVC/M12FSS PE	1411645	288	SAC-3P-5,0-PUR/DTFS	1414997	224	SAC-3P-10,0-PUR/M12FS-2L	1694790	188	SAC-3P-M 8MR/0,3-PUR/M12FR-2L	1682469	188
SAC-3P-3,0-800/M12FR	1456718	192	SAC-3P-5,0-PUR/M 8FR	1669631	188	SAC-3P-10,0-PVC/A	1402978	239	SAC-3P-M 8MR/0,3-PVC/M 8FR	1415891	190
SAC-3P-3,0-800/M12FR-2L	1456721	192	SAC-3P-5,0-PUR/M 8FR SH	1521782	193	SAC-3P-10,0-PVC/A-1L-R	1415919	237	SAC-3P-M 8MR/0,6-PUR/M 8FR	1682074	188
SAC-3P-3,0-800/M12FS	1456682	192	SAC-3P-5,0-PUR/M 8FR-2L	1671085	188	SAC-3P-10,0-PVC/A-1L-V	1415911	231	SAC-3P-M 8MR/0,6-PUR/M12FR-2L	1682472	188
SAC-3P-3,0-PUR/A	1439544	238	SAC-3P-5,0-PUR/M 8FS	1669628	188	SAC-3P-10,0-PVC/A-1L-V 230V	1415915	233	SAC-3P-M 8MR/0,6-PVC/M 8FR	1415892	190
SAC-3P-3,0-PUR/A-1L-R-ES	1413114	234	SAC-3P-5,0-PUR/M 8FS SH	1521737	193	SAC-3P-10,0-PVC/A-1L-Z	1439492	229	SAC-3P-M 8MR/1,5-PUR SH	1521669	193
SAC-3P-3,0-PUR/A-1L-R-ES 4A	1401131	235	SAC-3P-5,0-PUR/M 8SIFR	1519891	186	SAC-3P-10,0-PVC/B-1L-V	1415928	231	SAC-3P-M 8MR/1,5-PUR/M 8FR	1682087	188
SAC-3P-3,0-PUR/A-1L-V	1443116	230	SAC-3P-5,0-PUR/M 8SIFR	1519875	186	SAC-3P-10,0-PVC/B-1L-Z	1400610	229	SAC-3P-M 8MR/1,5-PUR/M12FR-2L	1682485	188
SAC-3P-3,0-PUR/A-1L-V 230V	1400694	232	SAC-3P-5,0-PUR/M12FR	1694525	188	SAC-3P-10,0-PVC/BI-1L-V	1415934	231	SAC-3P-M 8MR/1,5-PVC/M 8FR	1415893	190
SAC-3P-3,0-PUR/A-1L-Z	1434992	228	SAC-3P-5,0-PUR/M12FR B	1668218	188	SAC-3P-10,0-PVC/BI-1L-Z	1400607	229	SAC-3P-M 8MR/3,0-PUR SH	1521672	193
SAC-3P-3,0-PUR/B-1L-R-ES	1401295	234	SAC-3P-5,0-PUR/M12FR SH	1682838	193	SAC-3P-10,0-PVC/C-1L-V	1415938	231	SAC-3P-M 8MR/3,0-PUR/M 8FR	1682090	188
SAC-3P-3,0-PUR/B-1L-V	1443158	230	SAC-3P-5,0-PUR/M12FR-2L	1694415	188	SAC-3P-10,0-PVC/C-1L-Z	1439531	229	SAC-3P-M 8MR/3,0-PUR/M12FR-2L	1682498	188
SAC-3P-3,0-PUR/B-1L-Z	1435399	228	SAC-3P-5,0-PUR/M12FR-2L B	1668276	188	SAC-3P-10,0-PVC/CI-1L-V	1415944	231	SAC-3P-M 8MR/3,0-PVC/M 8FR	1415894	190
SAC-3P-3,0-PUR/BI-1L-R-ES	1401350	234	SAC-3P-5,0-PUR/M12FS	1683510	188	SAC-3P-10,0-PVC/CI-1L-Z	1400605	229	SAC-3P-M 8MR/5,0-PUR SH	1521685	193
SAC-3P-3,0-PUR/BI-1L-V	1443190	230	SAC-3P-5,0-PUR/M12FS B	1668098	188	SAC-3P-10,0-PVC/M 8FR	1403773	190	SAC-3P-M 8MR/.../...	1697551	188
SAC-3P-3,0-PUR/BI-1L-Z	1435247	228	SAC-3P-5,0-PUR/M12FS SH	1682809	193	SAC-3P-10,0-PVC/M 8FR-2L	1415876	190	SAC-3P-M 8MR/0,3-PUR/M 8FR-2L	1682100	188
SAC-3P-3,0-PUR/C-1L-R-ES	1401435	234	SAC-3P-5,0-PUR/M12FS-2L	1694787	188	SAC-3P-10,0-PVC/M 8FS	1506532	190	SAC-3P-M 8MR/0,3-PUR/M 8FS	1682029	188
SAC-3P-3,0-PUR/C-1L-V	1443239	230	SAC-3P-5,0-PVC/A	1402977	239	SAC-3P-10,0-PVC/M12FR	1453821	190	SAC-3P-M 8MR/0,3-PUR/M12FR	1682427	188
SAC-3P-3,0-PUR/C-1L-Z	1435548	228	SAC-3P-5,0-PVC/A-1L-R	1415918	237	SAC-3P-10,0-PVC/M12FR-2L	1414575	190	SAC-3P-M 8MR/0,3-PUR/M12FS	1682388	188
SAC-3P-3,0-PUR/CI-1L-R-ES	1401542	234	SAC-3P-5,0-PVC/A-1L-V	1415910	231	SAC-3P-10,0-PVC/M12FRS PE	1411651	288	SAC-3P-M 8MR/0,3-PVC/M 8FR-2L	1415901	190
SAC-3P-3,0-PUR/CI-1L-V	1443271	230	SAC-3P-5,0-PVC/A-1L-Z	1439502	229	SAC-3P-10,0-PVC/M12FS	1403486	190	SAC-3P-M 8MR/0,3-PVC/M 8FS	1415881	190
SAC-3P-3,0-PUR/CI-1L-Z	1435690	228	SAC-3P-5,0-PVC/B-1L-V	1415927	231	SAC-3P-10,0-PVC/M12FS-2L	1414565	190	SAC-3P-M 8MR/0,6-PUR/M 8FR-2L	1682113	188
SAC-3P-3,0-PUR/DTFS	1414996	244	SAC-3P-5,0-PVC/B-1L-Z	1415924	229	SAC-3P-10,0-PVC/M12FSS PE	1411647	288	SAC-3P-M 8MR/0,6-PUR/M 8FS	1682032	188
SAC-3P-3,0-PUR/M 8FR	1669741	188	SAC-3P-5,0-PVC/BI-1L-V	1415933	231	SAC-3P-100,0-534/0,75	1457432	304	SAC-3P-M 8MR/0,6-PUR/M12FR	1682430	188
SAC-3P-3,0-PUR/M 8FR SH	1521779	193	SAC-3P-5,0-PVC/BI-1L-Z	1415930	229	SAC-3P-100,0-PUR/0,25	1501689	302	SAC-3P-M 8MR/0,6-PUR/M12FS	1682391	188
SAC-3P-3,0-PUR/M 8FR-2L	1671072	188	SAC-3P-5,0-PVC/C-1L-V	1415937	231	SAC-3P-100,0-PUR/0,34	1501650	302	SAC-3P-M 8MR/0,6-PVC/M 8FR-2L	1415902	190
SAC-3P-3,0-PUR/M 8FS	1669725	188	SAC-3P-5,0-PVC/C-1L-Z	1439528	229	SAC-3P-100,0-PUR/0,5	1457393	304	SAC-3P-M 8MR/0,6-PVC/M 8FS	1415882	190
SAC-3P-3,0-PUR/M 8FS SH	1521724	193	SAC-3P-5,0-PVC/CI-1L-V	1415943	231	SAC-3P-100,0-PUR/SH-0,25	1526525	303	SAC-3P-M 8MR/1,5-PUR	1681693	188
SAC-3P-3,0-PUR/M12FR	1694512	188	SAC-3P-5,0-PVC/CI-1L-Z	1415940	229	SAC-3P-100,0-PUR/SH-0,34	1501702	303	SAC-3P-M 8MR/1,5-PUR/M 8FR	1682126	188
SAC-3P-3,0-PUR/M12FR B	1668205	188	SAC-3P-5,0-PVC/M 8FR	1403253	190	SAC-3P-100,0-PVC/0,25	1501854	302	SAC-3P-M 8MR/1,5-PUR/M 8FR-2L	1682045	188
SAC-3P-3,0-PUR/M12FR SH	1682825	193	SAC-3P-5,0-PVC/M 8FR-2L	1508174	190	SAC-3P-100,0-PVC/0,34	1501825	302	SAC-3P-M 8MR/1,5-PUR/M12FR	1682443	188
SAC-3P-3,0-PUR/M12FR-2L	1694402	188	SAC-3P-5,0-PVC/M 8FS	1510748	190	SAC-3P-100,0-PVC/SH-0,34	1550656	303	SAC-3P-M 8MR/1,5-PUR/M12FS	1682401	188
SAC-3P-3,0-PUR/M12FR-2L B	1668263	188	SAC-3P-5,0-PVC/M12FR	1579051	190	SAC-3P-15,0-961/M12FR VA	1419080	430	SAC-3P-M 8MR/1,5-PVC	1415865	190
SAC-3P-3,0-PUR/M12FS	1694499	188	SAC-3P-5,0-PVC/M12FR-2L	1505326	190	SAC-3P-15,0-961/M12FS VA	1419085	430	SAC-3P-M 8MR/1,5-PVC/M 8FR-2L	1415903	190
SAC-3P-3,0-PUR/M12FS B	1668085	188	SAC-3P-5,0-PVC/M12FRS PE	1411650	288	SAC-3P-20,0-961/M12FR VA	1419091	430	SAC-3P-M 8MR/1,5-PVC/M 8FS	1415883	190
SAC-3P-3,0-PUR/M12FS SH	1682799	193	SAC-3P-5,0-PVC/M12FS	1400505	190	SAC-3P-20,0-961/M12FS VA	1419086	430	SAC-3P-M 8MR/10,0-PUR	1694114	188
SAC-3P-3,0-PUR/M12FS-2L	1694198	188	SAC-3P-5,0-PVC/M12FS-2L	1508459	190	SAC-3P-3,0-PUR/A-1L-R	1400588	236	SAC-3P-M 8MR/10,0-PUR SH	1521698	193
SAC-3P-3,0-PVC/A	1415921	239	SAC-3P-5,0-PVC/M12FSS PE	1411646	288	SAC-3P-3,0-PVC/A-1L-R	1415917	237	SAC-3P-M 8MR/10,0-PVC	1415869	190
SAC-3P-3,0-PVC/A-1L-V	1415909	231	SAC-3P-1,5-PUR/A-1L-R	1400589	236	SAC-3P-5,0-PUR/A-1L-V 230V	1400648	232	SAC-3P-M 8MR/3,0-PUR	1681703	188
SAC-3P-3,0-PVC/A-1L-V 230V	1415913	233	SAC-3P-1,5-PVC/A-1L-R	1415916	237	SAC-3P-5,0-PUR/C	1400814	238	SAC-3P-M 8MR/3,0-PUR/M 8FR-2L	1682139	188
SAC-3P-3,0-PVC/A-1L-Z	1415905	229	SAC-3P-10,0-800/M12FR	1454299	192	SAC-3P-5,0-PVC/A-1L-V 230V	1415914	233	SAC-3P-M 8MR/3,0-PUR/M 8FS	1682058	188
SAC-3P-3,0-PVC/B-1L-V	1415926	231	SAC-3P-10,0-800/M12FR-2L	1454341	192	SAC-3P-A-1L-R/.../...	1417832	236	SAC-3P-M 8MR/3,0-PUR/M12FR	1682456	188
SAC-3P-3,0-PVC/B-1L-Z	1415923	229	SAC-3P-10,0-800/M12FS	1456705	192	SAC-3P-A-1L-V/.../...	1400876	230	SAC-3P-M 8MR/3,0-PUR/M12FS	1682414	188
SAC-3P-3,0-PVC/BI-1L-V	1415932	231	SAC-3P-10,0-961/M12FR VA	1419089	430	SAC-3P-A-1L-Z/.../...	1435027	228	SAC-3P-M 8MR/3,0-PVC	1415866	190
SAC-3P-3,0-PVC/BI-1L-Z	1400609	229	SAC-3P-10,0-961/M12FS VA	1419084	430	SAC-3P-A/.../...	1400897	238	SAC-3P-M 8MR/3,0-PVC/M 8FR-2L	1415904	190
SAC-3P-3,0-PVC/C-1L-V	1415936	231	SAC-3P-10,0-PUR/A	1400732	238	SAC-3P-B-1L-V/.../...	1400882	230	SAC-3P-M 8MR/3,0-PVC/M 8FS	1415884	190
SAC-3P-3,0-PVC/C-1L-Z	1439515	229	SAC-3P-10,0-PUR/A-1L-R	1400799	236	SAC-3P-B-1L-Z/.../...	1435425	228	SAC-3P-M 8MR/5,0-PUR	1681716	188
SAC-3P-3,0-PVC/CI-1L-V	1415942	231	SAC-3P-10,0-PUR/A-1L-R-ES	1413118	234	SAC-3P-B/.../...	1400909	238	SAC-3P-M 8MR/5,0-PVC	1415867	190
SAC-3P-3,0-PVC/CI-1L-Z	1415939	229	SAC-3P-10,0-PUR/A-1L-R-ES 4A	1401168	235	SAC-3P-BI-1L-V/.../...	1400879	230	SAC-3P-M 8MR/5,0-PUR	1521656	193
SAC-3P-3,0-PVC/M 8FR	1446320	190	SAC-3P-10,0-PUR/A-1L-V	1443132	230	SAC-3P-BI-1L-Z/.../...	1435276	228	SAC-3P-M 8MS-M 8FR SH/.../...	1552065	193
SAC-3P-3,0-PVC/M 8FR-2L	1415875	190	SAC-3P-10,0-PUR/A-1L-V 230V	1402986	232	SAC-3P-BI/.../...	1400902	238	SAC-3P-M 8MS-M 8FR-2L/.../...	1697658	188
SAC-3P-3,0-PVC/M 8FS	1415871	190	SAC-3P-10,0-PUR/A-1L-Z	1435014	228	SAC-3P-C-1L-V/.../...	1400894	230	SAC-3P-M 8MS-M 8FR/.../...	1697645	188
SAC-3P-3,0-PVC/M12FR	1414553	190	SAC-3P-10,0-PUR/B-1L-R-ES	1401339	234	SAC-3P-C-1L-Z/.../...	1435726	228	SAC-3P-M 8MS-M 8FS SH/.../...	1552052	193
SAC-3P-3,0-PVC/M12FR-2L	1414573	190	SAC-3P-10,0-PUR/B-1L-V	1443174	230	SAC-3P-C/.../...	1400921	238	SAC-3P-M 8MS-M 8FS/.../...	1697632	188
SAC-3P-3,0-PVC/M12FS	1414452	190	SAC-3P-10,0-PUR/BI-1L-Z	1435412	228	SAC-3P-CI-1L-V/.../...	1400891	230	SAC-3P-M 8MS-M12FR-2L/.../...	1697713	188
SAC-3P-3,0-PVC/M12FS-2L	1414561	190	SAC-3P-10,0-PUR/BI	1438862	238	SAC-3P-CI-1L-Z/.../...	1435577	228	SAC-3P-M 8MS-M12FR/.../...	1697700	188
SAC-3P-3,0-800/M12FR	1454273	192	SAC-3P-10,0-PUR/BI-1L-R-ES	1401359	234	SAC-3P-CI/.../...	1400918	238	SAC-3P-M 8MS-M12FS	1519749	254
SAC-3P-3,0-800/M12FR-2L	1454325	192	SAC-3P-10,0-PUR/BI-1L-V	1443213	230	SAC-3P-DTMS/0,3-PUR/DTFS	1415003	244	SAC-3P-M 8MS-M12FS-2L/.../...	1514197	188
SAC-3P-5,0-800/M12FS	1456695	192	SAC-3P-10,0-PUR/BI-1L-Z	1435263	228	SAC-3P-DTMS/0,6-PUR/DTFS	1415004	244	SAC-3P-M 8MS-M12FS/.../...	1697990	188
SAC-3P-5,0-961/M12FR VA	1419088	430	SAC-3P-10,0-PUR/C	1400641	238	SAC-3P-DTMS/1,5-PUR	1414999	244	SAC-3P-M 8MS/0,3-PUR/M 8FS	1681907	188
SAC-3P-5,0-961/M12FS VA	1419083	430	SAC-3P-10,0-PUR/C-1L-R-ES	1401465	234	SAC-3P-DTMS/1,5-PUR/DTFS	1415005	244	SAC-3P-M 8MS/0,3-PUR/M 8FS SH	1456310	193
SAC-3P-5,0-PUR/A	1402984	238	SAC-3P-10,0-PUR/C-1L-V	1443259	230	SAC-3P-DTMS/3,0-PUR	1415000	244	SAC-3P-M 8MS/0,3-PUR/M12FR-2L	1693351	188
SAC-3P-5,0-PUR/A-1L-R	1400798	236	SAC-3P-10,0-PUR/CI-1L-Z	1435564	228	SAC-3P-DTMS/3,0-PUR/DTFS	1415006	244	SAC-3P-M 8MS/0,3-PVC/M 8FS	1415877	190
SAC-3P-5,0-PUR/A-1L-R-ES	1413116	234	SAC-3P-10,0-PUR/CI-1L-R-ES	1401617	234	SAC-3P-DTMS/5,0-PUR	1415001	244	SAC-3P-M 8MS/0,6-PUR/M 8FS	1681910	188
SAC-3P-5,0-PUR/A-1L-R-ES 4A	1401136	235	SAC-3P-10,0-PUR/CI-1L								

Type	Order No.	Page	Type	Order No.	Page	Type	Order No.	Page	Type	Order No.	Page
SAC-3P-M 8MS/.../...	1697548	188	SAC-3P-M12MR/0,3-PUR/M12FS B	1668551	188	SAC-3P-M12MS/0,6-PUR/M12FR B	1668409	188	SAC-3P-M12MS/20,0-961 VA	1419096	430
SAC-3P-M 8MS/0,3-PUR/M 8FR	1681949	188	SAC-3P-M12MR/0,3-PVC/M 8FR	1415538	190	SAC-3P-M12MS/0,6-PUR/M12FR SH	1500936	193	SAC-3P-M12MS/20,0-961/M12FR VA	1419125	430
SAC-3P-M 8MS/0,3-PUR/M 8FR-2L	1681981	188	SAC-3P-M12MR/0,6-PUR/M12FS B	1415534	190	SAC-3P-M12MS/0,6-PUR/M12FR 2L	1694567	188	SAC-3P-M12MS/20,0-961/M12FS VA	1419109	430
SAC-3P-M 8MS/0,3-PUR/M12FR	1682346	188	SAC-3P-M12MR/0,6-PUR/M 8FR	1668920	188	SAC-3P-M12MS/0,6-PUR/M12FS SH	1500813	193	SAC-3P-M12MS/3,0-PUR	1688027	188
SAC-3P-M 8MS/0,3-PUR/M12FS	1682304	188	SAC-3P-M12MR/0,6-PUR/M 8FS	1668881	188	SAC-3P-M12MS/0,6-PVC/M12FR	1414581	190	SAC-3P-M12MS/3,0-PUR/M 8FR	1668965	188
SAC-3P-M 8MS/0,3-PVC/M 8FR	1415886	190	SAC-3P-M12MR/0,6-PUR/M12FR B	1668645	188	SAC-3P-M12MS/0,6-PVC/M12FR-2L	1415522	190	SAC-3P-M12MS/3,0-PUR/M 8FR-2L	1694910	188
SAC-3P-M 8MS/0,3-PVC/M 8FR-2L	1415896	190	SAC-3P-M12MR/0,6-PUR/M12FS B	1668564	188	SAC-3P-M12MS/1,0-961/M12FR VA	1419120	430	SAC-3P-M12MS/3,0-PUR/M 8FS	1668823	188
SAC-3P-M 8MS/0,6-PUR/M 8FR	1681952	188	SAC-3P-M12MR/0,6-PVC/M 8FR	1415539	190	SAC-3P-M12MS/1,0-961/M12FS VA	1419104	430	SAC-3P-M12MS/3,0-PUR/M12FR-2LB	1668467	188
SAC-3P-M 8MS/0,6-PUR/M 8FR-2L	1681994	188	SAC-3P-M12MR/0,6-PVC/M 8FS	1415535	190	SAC-3P-M12MS/1,5-800	1456734	192	SAC-3P-M12MS/3,0-PUR/M12FS	1681538	188
SAC-3P-M 8MS/0,6-PUR/M12FR	1682359	188	SAC-3P-M12MR/1,5-PUR	1668137	188	SAC-3P-M12MS/1,5-800/M12FR	1456831	192	SAC-3P-M12MS/3,0-PUR/M12FS B	1668344	188
SAC-3P-M 8MS/0,6-PUR/M12FS	1682317	188	SAC-3P-M12MR/1,5-PUR/M 8FR	1668933	188	SAC-3P-M12MS/1,5-800/M12FR-2L	1456873	192	SAC-3P-M12MS/3,0-PVC	1414435	190
SAC-3P-M 8MS/0,6-PVC/M 8FR	1415888	190	SAC-3P-M12MR/1,5-PUR/M 8FS	1668894	188	SAC-3P-M12MS/1,5-800/M12FS	1456792	192	SAC-3P-M12MS/3,0-PVC/M 8FR	1415533	190
SAC-3P-M 8MS/0,6-PVC/M 8FR-2L	1415897	190	SAC-3P-M12MR/1,5-PUR/M12FR B	1668658	188	SAC-3P-M12MS/1,5-PUR SH	1682650	193	SAC-3P-M12MS/3,0-PVC/M 8FS	1415529	190
SAC-3P-M 8MS/1,5-PUR	1681664	188	SAC-3P-M12MR/1,5-PUR/M12FS B	1668577	188	SAC-3P-M12MS/1,5-PUR/M12FR	1681567	188	SAC-3P-M12MS/3,0-PVC/M12FS	1414579	190
SAC-3P-M 8MS/1,5-PUR/M 8FR	1681965	188	SAC-3P-M12MR/1,5-PVC	1414447	190	SAC-3P-M12MS/1,5-PUR/M12FR B	1668412	188	SAC-3P-M12MS/5,0-PUR	1668030	188
SAC-3P-M 8MS/1,5-PUR/M 8FR-2L	1682003	188	SAC-3P-M12MR/1,5-PVC/M 8FR	1415540	190	SAC-3P-M12MS/1,5-PUR/M12FR SH	1500949	193	SAC-3P-M12MS/5,0-PVC	1693173	190
SAC-3P-M 8MS/1,5-PUR/M12FR	1682362	188	SAC-3P-M12MR/1,5-PVC/M 8FS	1415536	190	SAC-3P-M12MS/1,5-PUR/M12FR-2L	1694570	188	SAC-3P-M12MSS/1,0-PVC PE	1411636	288
SAC-3P-M 8MS/1,0-PUR	1682320	188	SAC-3P-M12MR/10,0-900	1456925	192	SAC-3P-M12MS/1,5-PUR/M12FS SH	1500826	193	SAC-3P-M12MSS/2,0-PVC PE	1411637	288
SAC-3P-M 8MS/1,5-PVC	1415861	190	SAC-3P-M12MR/10,0-961 VA	1419099	430	SAC-3P-M12MS/1,5-PVC/M12FR	1415519	190	SAC-3P-M12MSS/5,0-PVC PE	1411638	288
SAC-3P-M 8MS/1,5-PVC/M 8FR	1415889	190	SAC-3P-M12MR/10,0-961/M12FR VA	1419131	430	SAC-3P-M12MS/1,5-PVC/M12FR-2L	1415523	190	SAC-3P-M12MSS/10,0-PVC PE	1411639	288
SAC-3P-M 8MS/1,5-PVC/M 8FR-2L	1415898	190	SAC-3P-M12MR/10,0-961/M12FS VA	1419115	430	SAC-3P-M12MS/2,0-961 VA	1419092	430	SAC-3P-M12T/2XM12 B PE	1519723	252
SAC-3P-M 8MS/1,0-PUR	1693584	188	SAC-3P-M12MR/10,0-PUR	1694444	188	SAC-3P-M12MS/2,0-961/M12FR VA	1419121	430	SAC-3P-M12MSS/2,0-PVC PE	1697357	250
SAC-3P-M 8MS/10,0-PUR SH	1521643	193	SAC-3P-M12MR/10,0-PUR SH	1500677	193	SAC-3P-M12MS/2,0-961/M12FS VA	1419105	430	SAC-3P-M12Y-2XM 8FR-2L/.../...	1697412	250
SAC-3P-M 8MS/10,0-PVC	1447280	190	SAC-3P-M12MR/10,0-PVC	1414450	190	SAC-3P-M12MS/3,0-800	1456747	192	SAC-3P-M12Y-2XM 8FR/.../...	1697409	250
SAC-3P-M 8MS/3,0-PUR	1681677	188	SAC-3P-M12MR/15,0-961 VA	1419100	430	SAC-3P-M12MS/3,0-800/M12FR	1456844	192	SAC-3P-M12Y-2XM 8FS/.../...	1697399	250
SAC-3P-M 8MS/3,0-PUR/M 8FR	1681978	188	SAC-3P-M12MR/15,0-961/M12FR VA	1419132	430	SAC-3P-M12MS/3,0-800/M12FR-2L	1456886	192	SAC-3P-M12Y-2XM12FR B/.../...	1697373	250
SAC-3P-M 8MS/3,0-PUR/M 8FR-2L	1682016	188	SAC-3P-M12MR/15,0-961/M12FS VA	1419116	430	SAC-3P-M12MS/3,0-800/M12FS	1456802	192	SAC-3P-M12Y-2XM12FR-2LB/.../...	1697386	250
SAC-3P-M 8MS/3,0-PUR/M12FR	1682375	188	SAC-3P-M12MR/20,0-961 VA	1419101	430	SAC-3P-M12MS/3,0-PUR SH	1682663	193	SAC-3P-M12Y-2XM12FR/.../...	1506419	250
SAC-3P-M 8MS/3,0-PUR/M12FS	1682333	188	SAC-3P-M12MR/20,0-961/M12FR VA	1419133	430	SAC-3P-M12MS/3,0-PUR/M12FR	1681570	188	SAC-3P-M12Y-2XM12FS B/.../...	1697360	250
SAC-3P-M 8MS/3,0-PVC	1415862	190	SAC-3P-M12MR/20,0-961/M12FS VA	1419117	430	SAC-3P-M12MS/3,0-PUR/M12FR B	1688425	188	SAC-3P-M12Y-2XM12FS/.../...	1699766	250
SAC-3P-M 8MS/3,0-PVC/M 8FR	1415890	190	SAC-3P-M12MR/3,0-PUR	1668140	188	SAC-3P-M12MS/3,0-PUR/M12FR SH	1500952	193	SAC-3P-M12Y/2X0,3-PUR/M 8FR	1671373	250
SAC-3P-M 8MS/3,0-PVC/M 8FR-2L	1415899	190	SAC-3P-M12MR/3,0-PUR/M 8FR	1668946	188	SAC-3P-M12MS/3,0-PUR/M12FR-2L	1694583	188	SAC-3P-M12Y/2X0,3-PUR/M 8FR-2L	1671412	250
SAC-3P-M 8MS/5,0-PUR	1681680	188	SAC-3P-M12MR/3,0-PUR/M 8FS	1668904	188	SAC-3P-M12MS/3,0-PUR/M12FS SH	1500839	193	SAC-3P-M12Y/2X0,3-PUR/M 8FS	1671331	250
SAC-3P-M 8MS/5,0-PVC	1415863	190	SAC-3P-M12MR/3,0-PUR/M12FR B	1668661	188	SAC-3P-M12MS/3,0-PVC/M12FR	1415520	190	SAC-3P-M12Y/2X0,3-PUR/M12FR B	1668991	250
SAC-3P-M 8SIFR-2L/.../...	1513402	186	SAC-3P-M12MR/3,0-PUR/M12FS B	1668580	188	SAC-3P-M12MS/3,0-PVC/M12FR-2L	1415524	190	SAC-3P-M12Y/2X0,3-PUR/M12FR2LB	1669039	250
SAC-3P-M 8SIFR/.../...	1697629	186	SAC-3P-M12MR/3,0-PVC	1414448	190	SAC-3P-M12MS/3,0-PUR/M12FR SH	1456750	192	SAC-3P-M12Y/2X0,3-PUR/M12FS B	1668959	250
SAC-3P-M 8SIFS/.../...	1697593	186	SAC-3P-M12MR/3,0-PVC/M 8FR	1415541	190	SAC-3P-M12MS/5,0-961 VA	1419093	430	SAC-3P-M12Y/2X0,6-PUR/M 8FR	1671386	250
SAC-3P-M 8Y/2XM 8FS	1696183	252	SAC-3P-M12MR/3,0-PVC/M 8FS	1415537	190	SAC-3P-M12MS/5,0-961/M12FR VA	1419122	430	SAC-3P-M12Y/2X0,6-PUR/M 8FR-2L	1671425	250
SAC-3P-M 8Y/2XM 8FS VP	1696222	253	SAC-3P-M12MR/5,0-PUR	1668153	188	SAC-3P-M12MS/5,0-961/M12FS VA	1419106	430	SAC-3P-M12Y/2X0,6-PUR/M 8FS	1671344	250
SAC-3P-M12FR B/.../...	1696727	188	SAC-3P-M12MR/5,0-PVC	1414449	190	SAC-3P-M12MS/5,0-PUR SH	1682676	193	SAC-3P-M12Y/2X0,6-PUR/M12FR B	1669000	250
SAC-3P-M12FR SH/.../...	1697454	193	SAC-3P-M12MRS/1,0-PVC PE	1411640	288	SAC-3P-M12MS/5,0-961 VA	1419093	430	SAC-3P-M12Y/2X0,6-PUR/M12FR2LB	1669042	250
SAC-3P-M12FR-2L/.../...	1696730	188	SAC-3P-M12MRS/2,0-PVC PE	1411641	288	SAC-3P-M12MS/0,3-PUR/M 8FR	1668836	188	SAC-3P-M12Y/2X1,5-PUR/M12FS B	1668962	250
SAC-3P-M12FR-2LB/.../...	1696743	188	SAC-3P-M12MRS/5,0-PVC PE	1411642	288	SAC-3P-M12MS/0,3-PUR/M 8FR-2L	1694884	188	SAC-3P-M12Y/2X1,5-PUR	1669686	250
SAC-3P-M12FR/.../...	1696714	188	SAC-3P-M12MRS/10,0-PVC PE	1411643	288	SAC-3P-M12MS/0,3-PUR/M 8FS	1668797	188	SAC-3P-M12Y/2X1,5-PUR/M 8FR	1671399	250
SAC-3P-M12FS B/.../...	1696691	188	SAC-3P-M12MS SH/.../...	1697425	193	SAC-3P-M12MS/0,3-PUR/M12FR-2LB	1668438	188	SAC-3P-M12Y/2X1,5-PUR/M12FS B	1671438	250
SAC-3P-M12FS SH/.../...	1697441	193	SAC-3P-M12MS-M 8FR-2L/.../...	1696879	188	SAC-3P-M12MS/0,3-PUR/M12FS	1681509	188	SAC-3P-M12Y/2X1,5-PUR/M 8FS	1671357	250
SAC-3P-M12FS-2L/.../...	1696701	188	SAC-3P-M12MS-M 8FR/.../...	1696866	188	SAC-3P-M12MS/0,3-PUR/M12FS B	1668315	188	SAC-3P-M12Y/2X1,5-PUR/M12FR B	1669013	250
SAC-3P-M12FS/.../...	1696688	188	SAC-3P-M12MS-M 8SIFS	1519752	254	SAC-3P-M12MS/0,3-PVC/M 8FR	1415530	190	SAC-3P-M12Y/2X1,5-PUR/M12FR2LB	1669055	250
SAC-3P-M12MR SH/.../...	1697438	193	SAC-3P-M12MS-M 8SIFS/.../...	1696840	188	SAC-3P-M12MS/0,3-PVC/M 8FS	1415525	190	SAC-3P-M12Y/2X1,5-PUR/M12FS B	1668975	250
SAC-3P-M12MR-M 8FR-2L/.../...	1696918	188	SAC-3P-M12MS-M 8SIFR-2L/.../...	1515675	186	SAC-3P-M12MS/0,3-PVC/M12FS	1414576	190	SAC-3P-M12Y/2X10,0-PUR	1694473	250
SAC-3P-M12MR-M 8FR/.../...	1696905	188	SAC-3P-M12MS-M 8SIFR/.../...	1696882	186	SAC-3P-M12MS/0,6-PUR/M12FS	1668849	188	SAC-3P-M12Y/2X10,0-PUR	1696969	250
SAC-3P-M12MR-M 8FS/.../...	1696895	188	SAC-3P-M12MS-M 8SIFS	1519781	254	SAC-3P-M12MS/0,6-PUR/M 8FR-2L	1694897	188	SAC-3P-M12Y/2X3,0-PUR/M 8FR	1671409	250
SAC-3P-M12MR-M12FR B/.../...	1696824	188	SAC-3P-M12MS-M 8SIFS/.../...	1696853	186	SAC-3P-M12MS/0,6-PUR/M 8FS	1668807	188	SAC-3P-M12Y/2X3,0-PUR/M 8FR-2L	1671441	250
SAC-3P-M12MR-M12FR SH/.../...	1536078	193	SAC-3P-M12MS-M12FR B/.../...	1696785	188	SAC-3P-M12MS/0,6-PUR/M12FR-2LB	1668441	188	SAC-3P-M12Y/2X3,0-PUR/M12FS B	1671360	250
SAC-3P-M12MR-M12FR-2LB/.../...	1696837	188	SAC-3P-M12MS-M12FR SH/.../...	1536052	193	SAC-3P-M12MS/0,6-PUR/M12FS	1681512	188	SAC-3P-M12Y/2X3,0-PUR/M12FR B	1669026	250
SAC-3P-M12MR-M12FS B/.../...	1696811	188	SAC-3P-M12MS-M12FR-2L/.../...	1696798	188	SAC-3P-M12MS/0,6-PUR/M12FS B	1668328	188	SAC-3P-M12Y/2X3,0-PUR/M12FR2LB	1669068	250
SAC-3P-M12MR-M12FS SH/.../...	1536065	193	SAC-3P-M12MS-M12FR-2LB/.../...	1696808	188	SAC-3P-M12MS/0,6-PVC/M 8FR	1415531	190	SAC-3P-M12Y/2X3,0-PUR/M12FS B	1668988	250
SAC-3P-M12MR-M12FS-2L/.../...	1524763	188	SAC-3P-M12MS-M12FR/.../...	1696772	188	SAC-3P-M12MS/0,6-PVC/M 8FS	1415527	190	SAC-3P-M12Y/2X5,0-PUR	1669754	250
SAC-3P-M12MR/0,3-961/M12FS VA	1419126	430	SAC-3P-M12MS-M12FS B/.../...	1696769	188	SAC-3P-M12MS/0,6-PVC/M12FS	1414577	190	SAC-3P-M12Y/2XM 8FS	1668347	252
SAC-3P-M12MR/0,3-961/M12FS VA	1419110	430	SAC-3P-M12MS-M12FS SH/.../...	1536049	193	SAC-3P-M12MS/1,5-PUR	1668014	188	SAC-3P-M12Y/2XM 8FS VP	1683549	253
SAC-3P-M12MR/0,5-961/M12FR VA	1419127	430	SAC-3P-M12MS-M12FS-2L/.../...	1511802	188	SAC-3P-M12MS/1,5-PUR/M 8FR	1668852	188	SAC-3P-M12Y/2XM12FS 3L	1403627	252
SAC-3P-M12MR/0,5-961/M12FS VA	1419111	430	SAC-3P-M12MS-M12FS/.../...	1696756	188	SAC-3P-M12MS/1,5-PUR/M 8FR-2L	1694907	188	SAC-3P-M8Y/2X1,5-PUR	1683413	252
SAC-3P-M12MR/1,0-961/M12FR VA	1419128	430	SAC-3P-M12MS/0,3-800/M12FR	1456815	192	SAC-3P-M12MS/1,5-PUR/M 8FS	1668810	188	SAC-3P-M8Y/2X1,5-PUR/M12FS B PE S21	1514016	252
SAC-3P-M12MR/1,0-961/M12FS VA	1419112	430	SAC-3P-M12MS/0,3-800/M12FR-2L	1456857	192	SAC-3P-M12MS/1,5-PUR/M12FR-2LB	1668454	188	SAC-3P-M8Y/		

Index

Alphabetical

Type	Order No.	Page	Type	Order No.	Page	Type	Order No.	Page	Type	Order No.	Page
SAC-3P-M8Y/2X3,0-PUR/M 8FS	1458693	248	SAC-3P-PUR-0,25/...	1408505	303	SAC-4P-3,0-PVC/M12FS	1404407	196	SAC-4P-10,0-PVC/M12FS	1446333	196
SAC-3P-MR-A SCO/...	1400896	238	SAC-3P-PUR-0,34-SH/...	1408512	303	SAC-4P-3,0-PVC/M12FS-2L	1415597	196	SAC-4P-10,0-PVC/M12FS-2L	1415605	196
SAC-3P-MR-A-1L-V SCO/...	1417834	236	SAC-3P-PUR-0,34/...	1408506	303	SAC-4P-3,0-PVC/M12FSL	1425094	297	SAC-4P-10,0-PVC/M12FSL	1425096	297
SAC-3P-MR-A-1L-V SCO/...	1400875	230	SAC-3P-PUR-0,5/...	1408529	304	SAC-4P-5,0-105/M12FRL	1425039	296	SAC-4P-100,0-PUR/0,25	1501692	302
SAC-3P-MR-A-1L-Z SCO/...	1434976	228	SAC-3P-PVC-0,25/...	1408518	303	SAC-4P-5,0-105/M12FSL	1425035	296	SAC-4P-100,0-PUR/0,34	1501663	302
SAC-3P-MR-B SCO/...	1400905	238	SAC-3P-PVC-0,34-SH/...	1408525	303	SAC-4P-5,0-110/M12FRL	1425059	297	SAC-4P-100,0-PUR/SH-0,25	1535794	303
SAC-3P-MR-B-1L-V SCO/...	1400881	230	SAC-3P-PVC-0,34/...	1408519	303	SAC-4P-5,0-110/M12FSL	1089984	291	SAC-4P-100,0-PUR/SH-0,34	1501715	303
SAC-3P-MR-B-1L-Z SCO/...	1435373	228	SAC-4P-1,0-110/M12FRT	1089977	291	SAC-4P-5,0-110/M12FSL	1425055	297	SAC-4P-100,0-PVC/0,25	1501867	302
SAC-3P-MR-BI SCO/...	1400901	238	SAC-4P-1,0-110/M12FST	1089970	291	SAC-4P-5,0-110/M12FST	1089972	291	SAC-4P-100,0-PVC/0,34	1501838	302
SAC-3P-MR-BI-1L-V SCO/...	1400878	230	SAC-4P-1,0-PUR/FRS PE SCO	1408848	289	SAC-4P-5,0-186/M12FS	1509490	440	SAC-4P-100,0-PUR/SH-0,34	1505669	303
SAC-3P-MR-BI-1L-Z SCO/...	1435221	228	SAC-4P-1,0-PUR/M12FRT	1408827	290	SAC-4P-5,0-800/M12FR	1456970	198	SAC-4P-15,0-186/M12FS	1509513	440
SAC-3P-MR-C SCO/...	1400920	230	SAC-4P-1,0-PUR/M12FSS PE	1408843	289	SAC-4P-5,0-800/M12FR-3L	1567351	198	SAC-4P-15,0-960/M12FS VA	1431241	435
SAC-3P-MR-C-1L-V SCO/...	1400993	230	SAC-4P-1,0-PUR/M12FST	1408823	290	SAC-4P-5,0-800/M12FS	1567322	198	SAC-4P-3,0-PUR/AD	1438956	242
SAC-3P-MR-C-1L-Z SCO/...	1435674	228	SAC-4P-1,5-105/M12FRL	1425037	296	SAC-4P-5,0-960/M12FS VA	1431225	435	SAC-4P-3,0-PUR/M12FST SH	1424113	290
SAC-3P-MR-CI SCO/...	1400917	238	SAC-4P-1,5-105/M12FSL	1425033	296	SAC-4P-5,0-PUR/DIFS	1415010	244	SAC-4P-5,0-PUR/M12FST SH	1424114	290
SAC-3P-MR-CI-1L-V SCO/...	1400890	230	SAC-4P-1,5-110/M12FRL	1425057	297	SAC-4P-5,0-PUR/M 8FR	1681897	194	SAC-4P-AD/...	1400899	242
SAC-3P-MR-CI-1L-Z SCO/...	1435522	228	SAC-4P-1,5-110/M12FSL	1425053	297	SAC-4P-5,0-PUR/M 8FR SH	1521986	199	SAC-4P-DTMS/0,3-PUR/DIFS	1415016	244
SAC-3P-MR/0,3-PUR/A-1L-Z SCO	1434934	228	SAC-4P-1,5-800/M12FRL	1456954	198	SAC-4P-5,0-PUR/M 8FS	1681868	194	SAC-4P-DTMS/0,6-PUR/DIFS	1415017	244
SAC-3P-MR/0,3-PUR/B-1L-Z SCO	1435331	228	SAC-4P-1,5-800/M12FR-3L	1456996	198	SAC-4P-5,0-PUR/M 8FS SH	1521931	199	SAC-4P-DTMS/1,5-PUR	1415012	244
SAC-3P-MR/0,3-PUR/BI-1L-Z SCO	1435182	228	SAC-4P-1,5-800/M12FS	1456938	198	SAC-4P-5,0-PUR/M12FR	1668247	194	SAC-4P-DTMS/1,5-PUR/DIFS	1415019	244
SAC-3P-MR/0,3-PUR/C-1L-Z SCO	1435483	228	SAC-4P-1,5-PUR/DIFS	1415007	244	SAC-4P-5,0-PUR/M12FR SH	1682922	199	SAC-4P-DTMS/3,0-PUR	1415013	244
SAC-3P-MR/1,5-PUR/A-1L-Z SCO	1435632	228	SAC-4P-1,5-PUR/M 8FR	1681871	194	SAC-4P-5,0-PUR/M12FR-3L	1668302	194	SAC-4P-DTMS/3,0-PUR/DIFS	1415025	244
SAC-3P-MR/1,5-PUR/B-1L-Z SCO	1434947	228	SAC-4P-1,5-PUR/M 8FR SH	1521960	199	SAC-4P-5,0-PUR/M12FRL	1425079	296	SAC-4P-DTMS/5,0-PUR	1415014	244
SAC-3P-MR/1,5-PUR/BI-1L-Z SCO	1435344	228	SAC-4P-1,5-PUR/M 8FS	1681842	194	SAC-4P-5,0-PUR/M12FRS PE	1408853	289	SAC-4P-DTMS/10,0-PUR	1415015	244
SAC-3P-MR/0,6-PUR/BI-1L-Z SCO	1435195	228	SAC-4P-1,5-PUR/M 8FS SH	1521915	199	SAC-4P-5,0-PUR/M12FRS PE SH	1424102	289	SAC-4P-M 8FR SH/...	1522008	199
SAC-3P-MR/0,6-PUR/C-1L-Z SCO	1435496	228	SAC-4P-1,5-PUR/M12FR	1668221	194	SAC-4P-5,0-PUR/M12FRT	1408829	290	SAC-4P-M 8FR-2L/...	1517673	194
SAC-3P-MR/0,6-PUR/CI-1L-Z SCO	1435645	228	SAC-4P-1,5-PUR/M12FR SH	1682906	199	SAC-4P-5,0-PUR/M12FRT SH	1424118	290	SAC-4P-M 8FR/...	1697784	194
SAC-3P-MR/1,5-PUR/A-1L-Z SCO	1434950	228	SAC-4P-1,5-PUR/M12FR-3L	1668289	194	SAC-4P-5,0-PUR/M12FS	1668124	194	SAC-4P-M 8FR SH/...	1521957	199
SAC-3P-MR/1,5-PUR/B-1L-Z SCO	1435357	228	SAC-4P-1,5-PUR/M12FRL	1425077	296	SAC-4P-5,0-PUR/M12FS SH	1682867	199	SAC-4P-M 8FS/...	1697771	194
SAC-3P-MR/1,5-PUR/BI-1L-Z SCO	1435205	228	SAC-4P-1,5-PUR/M12FRS PE SH	1424100	289	SAC-4P-5,0-PUR/M12FS-2L	1694826	194	SAC-4P-M 8MR SH/...	1521902	199
SAC-3P-MR/1,5-PUR/CI-1L-Z SCO	1435056	228	SAC-4P-1,5-PUR/M12FRT SH	1424116	290	SAC-4P-5,0-PUR/M12FSL	1425075	296	SAC-4P-M 8MR-M 8FR SH/...	1552120	199
SAC-3P-MR/1,5-PUR/CI-1L-Z SCO	1435658	228	SAC-4P-1,5-PUR/M12FS	1668108	194	SAC-4P-5,0-PUR/M12FSS PE	1408845	289	SAC-4P-M 8MR-M 8FR/...	1697823	194
SAC-3P-MR/3,0-PUR/A-1L-Z SCO	1434963	228	SAC-4P-1,5-PUR/M12FS SH	1682841	199	SAC-4P-5,0-PUR/M12FSS PE SH	1424098	289	SAC-4P-M 8MR-M 8FS/...	1697810	194
SAC-3P-MR/3,0-PUR/B-1L-Z SCO	1435360	228	SAC-4P-1,5-PUR/M12FS-2L	1694800	194	SAC-4P-5,0-PUR/M12FST	1408825	290	SAC-4P-M 8MR-M12FR/...	1697836	194
SAC-3P-MR/3,0-PUR/BI-1L-Z SCO	1435218	228	SAC-4P-1,5-PUR/M12FSL	1425073	296	SAC-4P-5,0-PUR/M 8FR	1403254	196	SAC-4P-M 8MR/1,5-PUR SH	1521863	199
SAC-3P-MR/3,0-PUR/CI-1L-Z SCO	1435519	228	SAC-4P-1,5-PUR/M12FSS PE SH	1424096	289	SAC-4P-5,0-PVC/M 8FS	1403252	196	SAC-4P-M 8MR/3,0-PUR SH	1521876	199
SAC-3P-MR/3,0-PUR/CI-1L-Z SCO	1435661	228	SAC-4P-1,5-PVC/M 8FR	1415552	196	SAC-4P-5,0-PVC/M12FR	1693539	196	SAC-4P-M 8MR/5,0-PUR SH	1521889	199
SAC-3P-MR/A-1L-Z SCO	1458538	256	SAC-4P-1,5-PVC/M 8FS	1415550	196	SAC-4P-5,0-PVC/M12FR-3L	1404961	196	SAC-4P-M 8MR/...	1697768	194
SAC-3P-MR/B-1L-Z SCO	1458554	257	SAC-4P-1,5-PVC/M12FR	1415606	196	SAC-4P-5,0-PVC/M12FRL	1425099	297	SAC-4P-M 8MR/0,3-PUR/M 8FR	1682265	194
SAC-3P-MR/BI-1L-Z SCO	1458570	257	SAC-4P-1,5-PVC/M12FR-3L	1415609	196	SAC-4P-5,0-PVC/M12FS	1404408	196	SAC-4P-M 8MR/0,3-PUR/M 8FS	1682223	194
SAC-3P-MS-A SCO/...	1400895	238	SAC-4P-1,5-PVC/M12FRL	1425097	297	SAC-4P-5,0-PVC/M12FS-2L	1415602	196	SAC-4P-M 8MR/0,3-PVC/M 8FR	1415580	196
SAC-3P-MS-A-1L-R SCO/...	1417833	236	SAC-4P-1,5-PVC/M12FS	1544976	196	SAC-4P-5,0-PVC/M12FSL	1425095	297	SAC-4P-M 8MR/0,6-PUR/M 8FS	1415576	196
SAC-3P-MS-A-1L-V SCO/...	1400874	230	SAC-4P-1,5-PVC/M12FS-2L	1415596	196	SAC-4P-1,5-PUR/M12FST SH	1424112	290	SAC-4P-M 8MR/0,6-PUR/M 8FR	1682278	194
SAC-3P-MS-A-1L-Z SCO/...	1434921	228	SAC-4P-1,5-PVC/M12FSL	1425093	297	SAC-4P-10,0-105/M12FRL	1425040	296	SAC-4P-M 8MR/0,6-PUR/M 8FS	1682236	194
SAC-3P-MS-B SCO/...	1400903	238	SAC-4P-2,0-110/M12FRT	1089981	291	SAC-4P-10,0-105/M12FSL	1425036	296	SAC-4P-M 8MR/0,6-PVC/M 8FR	1415581	196
SAC-3P-MS-B-1L-V SCO/...	1400880	230	SAC-4P-2,0-110/M12FST	1089971	291	SAC-4P-10,0-110/M12FRL	1425060	297	SAC-4P-M 8MR/0,6-PUR/M 8FS	1415577	196
SAC-3P-MS-B-1L-Z SCO/...	1435328	228	SAC-4P-2,0-186/M12FS	1509487	440	SAC-4P-10,0-110/M12FSL	1089987	291	SAC-4P-M 8MR/1,5-PUR	1681813	194
SAC-3P-MS-BI SCO/...	1400900	238	SAC-4P-2,0-960/M12FS VA	1431212	435	SAC-4P-10,0-110/M12FSL	1425056	297	SAC-4P-M 8MR/1,5-PUR/M 8FR	1682281	194
SAC-3P-MS-BI-1L-V SCO/...	1400877	230	SAC-4P-2,0-PUR/M12FRS PE	1408852	289	SAC-4P-10,0-110/M12FST	1089973	291	SAC-4P-M 8MR/1,5-PUR/M 8FS	1682249	194
SAC-3P-MS-BI-1L-Z SCO/...	1435179	228	SAC-4P-2,0-PUR/M12FRT	1408828	290	SAC-4P-10,0-186/M12FS	1509500	440	SAC-4P-M 8MR/1,5-PVC	1415546	196
SAC-3P-MS-C SCO/...	1400919	238	SAC-4P-2,0-PUR/M12FSS PE	1408844	289	SAC-4P-10,0-800/M12FR	1456983	198	SAC-4P-M 8MR/10,0-PVC	1415582	196
SAC-3P-MS-C-1L-V SCO/...	1400892	230	SAC-4P-2,0-PUR/M12FST	1408824	290	SAC-4P-10,0-800/M12FR-3L	1567364	198	SAC-4P-M 8MR/1,5-PVC/M 8FS	1415578	196
SAC-3P-MS-C-1L-Z SCO/...	1435629	228	SAC-4P-3,0-105/M12FRL	1425038	296	SAC-4P-10,0-800/M12FS	1567335	198	SAC-4P-M 8MR/10,0-PUR	1694156	194
SAC-3P-MS-CI SCO/...	1400916	238	SAC-4P-3,0-105/M12FSL	1425034	296	SAC-4P-10,0-960/M12FS VA	1431238	435	SAC-4P-M 8MR/10,0-PUR SH	1521892	199
SAC-3P-MS-CI-1L-V SCO/...	1400889	230	SAC-4P-3,0-110/M12FRL	1425058	297	SAC-4P-10,0-PUR/DIFS	1415011	244	SAC-4P-M 8MR/10,0-PVC	1415549	196
SAC-3P-MS-CI-1L-Z SCO/...	1435470	228	SAC-4P-3,0-110/M12FSL	1425054	297	SAC-4P-10,0-PUR/M 8FR	1694172	194	SAC-4P-M 8MR/3,0-PUR	1681826	194
SAC-3P-MS/0,3-PUR/A-1L-Z SCO	1434882	228	SAC-4P-3,0-800/M12FR	1456967	198	SAC-4P-10,0-PUR/M 8FR SH	1521999	199	SAC-4P-M 8MR/3,0-PUR/M 8FR	1682294	194
SAC-3P-MS/0,3-PUR/B-1L-Z SCO	1435289	228	SAC-4P-3,0-800/M12FR-3L	1457005	198	SAC-4P-10,0-PUR/M 8FS	1683484	194	SAC-4P-M 8MR/3,0-PUR/M 8FS	1682252	194
SAC-3P-MS/0,3-PUR/BI-1L-Z SCO	1435137	228	SAC-4P-3,0-800/M12FS	1456941	198	SAC-4P-10,0-PUR/M 8FS SH	1521944	199	SAC-4P-M 8MR/3,0-PVC	1415547	196
SAC-3P-MS/0,3-PUR/CI-1L-Z SCO	1435438	228	SAC-4P-3,0-PUR/DIFS	1415008	244	SAC-4P-10,0-PUR/M12FR	1681389	194	SAC-4P-M 8MR/3,0-PVC/M 8FR	1415583	196
SAC-3P-MS/0,3-PUR/CI-1L-Z SCO	1435580	228	SAC-4P-3,0-PUR/M 8FR	1681884	194	SAC-4P-10,0-PUR/M12FR SH	1500729	199	SAC-4P-M 8MR/3,0-PVC/M 8FS	1415579	196
SAC-3P-MS/0,6-PUR/A-1L-Z SCO	1434895	228	SAC-4P-3,0-PUR/M 8FR SH	1521973	199	SAC-4P-10,0-PUR/M12FR-3L	1681020	194	SAC-4P-M 8MR/5,0-PUR	1681839	194
SAC-3P-MS/0,6-PUR/B-1L-Z SCO	1435292	228	SAC-4P-3,0-PUR/M 8FS	1681855	194	SAC-4P-10,0-PUR/M12FRL	1425080	296	SAC-4P-M 8MR/5,0-PVC	1415548	196
SAC-3P-MS/0,6-PUR/BI-1L-Z SCO	1435140	228	SAC-4P-3,0-PUR/M 8FS SH	1521928	199	SAC-4P-10,0-PUR/M12FRS PE	1408854	289	SAC-4P-M 8MR/5,0-PUR	1521850	199
SAC-3P-MS/0,6-PUR/CI-1L-Z SCO	1435441	228	SAC-4P-3,0-PUR/M12FR	1668234	194	SAC-4P-10,0-PUR/M12FRS PE SH	1424103	289	SAC-4P-M 8MS-M 8FR SH/...	1552104	199
SAC-3P-MS/0,6-PUR/CI-1L-Z SCO	1435593	228	SAC-4P-3,0-PUR/M12FR SH	1682919	194	SAC-4P-10,0-PUR/M12FST	1408830	290	SAC-4P-M 8MS-M 8FR/...	1697807	194
SAC-3P-MS/1,5-PUR/A-1L-Z SCO	1434905	228	SAC-4P-3,0-PUR/M12FR-3L	1668292	194	SAC-4P-10,0-PUR/M12FRT SH	1424128	290	SAC-4P-M 8MS-M 8FS SH/...	1552094	199
SAC-3P-MS/1,5-PUR/B-1L-Z SCO	1435302	228	SAC-4P-3,0-PUR/M								

Type	Order No.	Page	Type	Order No.	Page	Type	Order No.	Page	Type	Order No.	Page
SAC-4P-M 8MS/0,3-PUR/M 8FS	1682142	194	SAC-4P-M12MR/10,0-PUR SH	1500703	199	SAC-4P-M12MS/0,3-PUR/M12FR SH	1500965	199	SAC-4P-M12MS/3,0-PUR/M12FR	1668506	194
SAC-4P-M 8MS/0,3-PVC/M 8FR	1415562	196	SAC-4P-M12MR/10,0-PVC	1415594	196	SAC-4P-M12MS/0,3-PUR/M12FS	1668357	194	SAC-4P-M12MS/3,0-PUR/M12FR-3L	1668548	194
SAC-4P-M 8MS/0,3-PVC/M 8FS	1415556	196	SAC-4P-M12MR/3,0-PUR	1668179	194	SAC-4P-M12MS/0,3-PUR/M12FS SH	1500842	199	SAC-4P-M12MS/3,0-PVC/M 8FS	1415674	196
SAC-4P-M 8MS/0,6-PUR/M 8FR	1682197	194	SAC-4P-M12MR/3,0-PUR/M 8FR	1671580	194	SAC-4P-M12MS/0,3-PVC/M12FR	1415617	196	SAC-4P-M12MS/3,0-PVC/M12FR	1415619	196
SAC-4P-M 8MS/0,6-PUR/M 8FS	1682155	194	SAC-4P-M12MR/3,0-PUR/M12FR	1668742	194	SAC-4P-M12MS/0,3-PVC/M12FS	1415611	196	SAC-4P-M12MS/3,0-PVC/M12FR-3L	1415625	196
SAC-4P-M 8MS/0,6-PVC/M 8FR	1415572	196	SAC-4P-M12MR/3,0-PUR/M12FR-3L	1668784	194	SAC-4P-M12MS/0,5-186/M12FS	1509539	440	SAC-4P-M12MSL/1,5-105	1425025	296
SAC-4P-M 8MS/0,6-PVC/M 8FS	1415557	196	SAC-4P-M12MR/3,0-PUR/M12FS	1668629	194	SAC-4P-M12MS/0,5-960/M12FS VA	1431267	435	SAC-4P-M12MSL/3,0-110	1425045	297
SAC-4P-M 8MS/1,5-PUR	1681787	194	SAC-4P-M12MR/3,0-PVC	1415592	196	SAC-4P-M12MS/0,6-800/M12FR	1567225	198	SAC-4P-M12MSL/1,5-PUR	1425065	296
SAC-4P-M 8MS/1,5-PUR/M 8FR	1682207	194	SAC-4P-M12MR/3,0-PVC/M 8FR	1415670	196	SAC-4P-M12MS/0,6-800/M12FS	1457063	198	SAC-4P-M12MSL/1,5-PVC	1425058	297
SAC-4P-M 8MS/1,5-PUR/M 8FS	1682168	194	SAC-4P-M12MR/3,0-PVC/M12FR	1415645	196	SAC-4P-M12MS/0,6-PUR/M12FR	1668483	194	SAC-4P-M12MSL/3,0-105	1425026	296
SAC-4P-M 8MS/1,5-PVC	1415542	196	SAC-4P-M12MR/3,0-PVC/M12FR-3L	1415650	196	SAC-4P-M12MS/0,6-PUR/M12FR SH	1500978	199	SAC-4P-M12MSL/3,0-110	1425046	297
SAC-4P-M 8MS/1,5-PVC/M 8FR	1415573	196	SAC-4P-M12MR/3,0-PVC/M12FS	1415636	196	SAC-4P-M12MS/0,6-PUR/M12FS	1668360	194	SAC-4P-M12MSL/3,0-PUR	1425066	296
SAC-4P-M 8MS/1,5-PVC/M 8FS	1415558	196	SAC-4P-M12MR/5,0-PUR	1668182	194	SAC-4P-M12MS/0,6-PUR/M12FS SH	1500855	199	SAC-4P-M12MSL/3,0-PVC	1425086	297
SAC-4P-M 8MS/10,0-PUR	1694143	194	SAC-4P-M12MR/5,0-PVC	1415593	196	SAC-4P-M12MS/0,6-PVC/M12FR	1454817	196	SAC-4P-M12MSL/5,0-105	1425027	296
SAC-4P-M 8MS/10,0-PUR SH	1521847	199	SAC-4P-M12MRL/1,5-105	1425029	296	SAC-4P-M12MS/0,6-PVC/M12FS	1415612	196	SAC-4P-M12MSL/5,0-110	1425047	297
SAC-4P-M 8MS/10,0-PVC	1415545	196	SAC-4P-M12MRL/1,5-110	1425049	297	SAC-4P-M12MS/1,0-186/M12FS	1509542	440	SAC-4P-M12MSL/5,0-PUR	1425067	296
SAC-4P-M 8MS/3,0-PUR	1681790	194	SAC-4P-M12MRL/1,5-PUR	1425069	296	SAC-4P-M12MS/1,0-960/M12FS VA	1431270	435	SAC-4P-M12MSL/5,0-PVC	1425087	297
SAC-4P-M 8MS/3,0-PUR/M 8FR	1682210	194	SAC-4P-M12MRL/1,5-PVC	1425089	297	SAC-4P-M12MS/1,5-800	1457018	198	SAC-4P-M12MSL/5,0-105/FSL	1425042	296
SAC-4P-M 8MS/3,0-PUR/M 8FS	1682171	194	SAC-4P-M12MRL/3,0-105	1425030	296	SAC-4P-M12MS/1,5-800/M12FR	1567238	198	SAC-4P-M12MSL/3,0-110/FSL	1425061	297
SAC-4P-M 8MS/3,0-PVC	1415543	196	SAC-4P-M12MRL/3,0-110	1425050	297	SAC-4P-M12MS/1,5-800/M12FS	1567270	198	SAC-4P-M12MSL/0,3-PUR/FSL	1425081	296
SAC-4P-M 8MS/3,0-PVC/M 8FR	1415574	196	SAC-4P-M12MRL/3,0-PUR	1425070	296	SAC-4P-M12MS/1,5-PUR	1668043	194	SAC-4P-M12MSL/0,3-PVC/FSL	1425101	297
SAC-4P-M 8MS/3,0-PVC/M 8FS	1415560	196	SAC-4P-M12MRL/3,0-PVC	1425090	297	SAC-4P-M12MS/1,5-PUR SH	1682715	199	SAC-4P-M12MSL/3,0-105/FSL	1425042	296
SAC-4P-M 8MS/5,0-PUR	1681800	194	SAC-4P-M12MRL/5,0-105	1425031	296	SAC-4P-M12MS/1,5-PUR/M12FR SH	1500981	199	SAC-4P-M12MSL/0,6-110/FSL	1425062	297
SAC-4P-M 8MS/5,0-PVC	1415544	196	SAC-4P-M12MRL/5,0-110	1425051	297	SAC-4P-M12MS/1,5-PUR/M12FS	1668373	194	SAC-4P-M12MSL/0,6-PUR/FSL	1425082	296
SAC-4P-M 8SIFR-2L/././././	1511954	186	SAC-4P-M12MRL/5,0-PUR	1425071	296	SAC-4P-M12MS/1,5-PUR/M12FS SH	1500868	199	SAC-4P-M12MSL/0,6-PVC/FSL	1425102	297
SAC-4P-M 8SIFR/././././	1513392	186	SAC-4P-M12MRL/5,0-PVC	1425091	297	SAC-4P-M12MS/1,5-PVC	1415585	196	SAC-4P-M12MSL/1,5-105/FSL	1425043	296
SAC-4P-M 8SIFS/././././	1513389	186	SAC-4P-M12MRL/10,0-105	1425032	296	SAC-4P-M12MS/1,5-PVC/M12FS	1415613	196	SAC-4P-M12MSL/1,5-110/FSL	1425063	297
SAC-4P-M12FR FF VA/./././	1431351	435	SAC-4P-M12MRL/10,0-110	1425052	297	SAC-4P-M12MS/2,0-186	1509445	440	SAC-4P-M12MSL/1,5-PUR/FSL	1425083	296
SAC-4P-M12FR SH/././././	1697496	199	SAC-4P-M12MRL/10,0-PUR	1425072	296	SAC-4P-M12MS/2,0-186/M12FS	1509555	440	SAC-4P-M12MSL/1,5-PVC/FSL	1425103	297
SAC-4P-M12FR-3L/././././	1696992	194	SAC-4P-M12MRL/10,0-PVC	1425092	297	SAC-4P-M12MS/2,0-960 VA	1431173	435	SAC-4P-M12MSL/10,0-105	1425028	296
SAC-4P-M12FR/././././	1696989	194	SAC-4P-M12MRS/1,0-PUR PE	1424839	289	SAC-4P-M12MS/2,0-960/M12FS VA	1431283	435	SAC-4P-M12MSL/10,0-110	1425048	297
SAC-4P-M12FS FF VA/./././	1431348	435	SAC-4P-M12MRS/1,5-PUR PE SH	1400108	289	SAC-4P-M12MS/3,0-800	1457021	198	SAC-4P-M12MSL/10,0-PUR	1425068	296
SAC-4P-M12FS SH/././././	1697483	199	SAC-4P-M12MRS/2,0-PUR PE	1408840	289	SAC-4P-M12MS/3,0-800/M12FR	1457092	198	SAC-4P-M12MSL/10,0-PVC	1425088	297
SAC-4P-M12FS-2L/././././	1696976	194	SAC-4P-M12MRS/3,0-PUR PE SH	1424109	289	SAC-4P-M12MS/3,0-800/M12FR-3L	1457115	198	SAC-4P-M12MSL/3,0-105/FSL	1425044	296
SAC-4P-M12FS/././././	1696963	194	SAC-4P-M12MRS/5,0-PUR PE	1408841	289	SAC-4P-M12MS/3,0-800/M12FS	1457076	198	SAC-4P-M12MSL/3,0-110/FSL	1425064	297
SAC-4P-M12MR FF VA/./././	1431335	435	SAC-4P-M12MRS/5,0-PUR PE SH	1424110	289	SAC-4P-M12MS/3,0-PUR	1668056	194	SAC-4P-M12MSL/3,0-PUR/FSL	1425084	296
SAC-4P-M12MR SH/././././	1697470	199	SAC-4P-M12MRS/10,0-PUR PE	1408842	289	SAC-4P-M12MS/3,0-PUR SH	1682618	199	SAC-4P-M12MSL/3,0-PVC/FSL	1425104	297
SAC-4P-M12MR-M 8FS/././././	1507874	194	SAC-4P-M12MRS/10,0-PUR PE SH	1424111	289	SAC-4P-M12MS/3,0-PUR/M12FR SH	1500994	199	SAC-4P-M12MSS/1,0-PUR PE	1408835	289
SAC-4P-M12MR-M12FR FF VA/././	1431393	435	SAC-4P-M12MRT/1,0-110	1089958	291	SAC-4P-M12MS/3,0-PUR/M12FS	1668386	194	SAC-4P-M12MSS/1,5-PUR PE SH	1424104	289
SAC-4P-M12MR-M12FR SH/./././	1536117	199	SAC-4P-M12MRT/1,0-PUR	1408816	290	SAC-4P-M12MS/3,0-PUR/M12FS SH	1500871	199	SAC-4P-M12MSS/2,0-PUR PE	1408836	289
SAC-4P-M12MR-M12FR-3L/./././	1697056	194	SAC-4P-M12MRT/1,0-PUR/M12FRT	1415196	290	SAC-4P-M12MS/3,0-PVC	1415588	196	SAC-4P-M12MSS/3,0-PUR PE SH	1424105	289
SAC-4P-M12MR-M12FR/././././	1697043	194	SAC-4P-M12MRT/1,5-PUR SH	1424124	290	SAC-4P-M12MS/3,0-PVC/M12FS	1415614	196	SAC-4P-M12MSS/5,0-PUR PE	1408837	289
SAC-4P-M12MR-M12FS FF VA/././	1431377	435	SAC-4P-M12MRT/1,5-PUR/FRT SH	1415202	290	SAC-4P-M12MS/5,0-186	1509458	440	SAC-4P-M12MSS/5,0-PUR PE SH	1424245	289
SAC-4P-M12MR-M12FS SH/./././	1536104	199	SAC-4P-M12MRT/10,0-PUR/FRT SH	1415205	290	SAC-4P-M12MS/5,0-186/M12FS	1509568	440	SAC-4P-M12MSS/10,0-PUR PE	1408838	289
SAC-4P-M12MR-M12FS/././././	1697030	194	SAC-4P-M12MRT/2,0-110	1089961	291	SAC-4P-M12MS/5,0-800	1457034	198	SAC-4P-M12MSS/10,0-PUR PE SH	1424107	289
SAC-4P-M12MR/1,5-800	1457128	198	SAC-4P-M12MRT/2,0-PUR	1408819	290	SAC-4P-M12MS/5,0-960 VA	1431186	435	SAC-4P-M12MST/1,0-110	1089952	291
SAC-4P-M12MR/1,5-PUR SH	1682890	199	SAC-4P-M12MRT/2,0-PUR/M12FRT	1415197	290	SAC-4P-M12MS/5,0-960/M12FS VA	1431296	435	SAC-4P-M12MST/1,0-110/M12FST	1089988	291
SAC-4P-M12MR/3,0-800	1457131	198	SAC-4P-M12MRT/3,0-PUR SH	1424125	290	SAC-4P-M12MS/5,0-PUR	1668069	194	SAC-4P-M12MST/1,0-PUR	1408812	290
SAC-4P-M12MR/3,0-PUR SH	1682883	199	SAC-4P-M12MRT/3,0-PUR/FRT SH	1415203	290	SAC-4P-M12MS/5,0-PUR SH	1682647	199	SAC-4P-M12MST/1,0-PUR/M12FST	1408808	290
SAC-4P-M12MR/5,0-800	1457144	198	SAC-4P-M12MRT/5,0-110	1089965	291	SAC-4P-M12MS/5,0-PVC	1415589	196	SAC-4P-M12MST/1,5-PUR SH	1424120	290
SAC-4P-M12MR/5,0-PUR SH	1682896	199	SAC-4P-M12MRT/5,0-PUR	1408820	290	SAC-4P-M12MS/././././	1696947	194	SAC-4P-M12MST/2,0-110	1089953	291
SAC-4P-M12MR/././././	1696950	194	SAC-4P-M12MRT/5,0-PUR SH	1424126	290	SAC-4P-M12MS/0,3-PUR/M 8FS	1694923	194	SAC-4P-M12MST/2,0-110/M12FST	1089997	291
SAC-4P-M12MR/0,3-PUR/M 8FR	1671551	194	SAC-4P-M12MRT/5,0-PUR/FRT SH	1415204	290	SAC-4P-M12MS/0,3-PUR/M12FR-3L	1668519	194	SAC-4P-M12MST/2,0-PUR	1408813	290
SAC-4P-M12MR/0,3-PUR/M12FR	1688713	194	SAC-4P-M12MRT/5,0-PUR/M12FRT	1415198	290	SAC-4P-M12MS/0,3-PVC/M 8FS	1415671	196	SAC-4P-M12MST/2,0-PUR/M12FST	1408809	290
SAC-4P-M12MR/0,3-PUR/M12FR-3L	1668755	194	SAC-4P-M12MRT/10,0-110	1089968	291	SAC-4P-M12MS/0,3-PVC/M12FR-3L	1415620	196	SAC-4P-M12MST/3,0-PUR SH	1424121	290
SAC-4P-M12MR/0,3-PUR/M12FS	1668593	194	SAC-4P-M12MRT/10,0-PUR	1408822	290	SAC-4P-M12MS/0,6-800/M12FR-3L	1567173	198	SAC-4P-M12MST/5,0-110	1089955	291
SAC-4P-M12MR/0,3-PVC/M 8FR	1415667	196	SAC-4P-M12MRT/10,0-PUR SH	1424127	290	SAC-4P-M12MS/0,6-PUR/M 8FS	1693076	194	SAC-4P-M12MST/5,0-110/M12FST	1089998	291
SAC-4P-M12MR/0,3-PVC/M12FR	1415642	196	SAC-4P-M12MRT/10,0-PUR/M12FRT	1415199	290	SAC-4P-M12MS/0,6-PUR/M12FR-3L	1668522	194	SAC-4P-M12MST/5,0-PUR	1408814	290
SAC-4P-M12MR/1,5-PUR/M 8FR	1415646	196	SAC-4P-M12MS CCL TR	1558470	437	SAC-4P-M12MS/0,6-PVC/M 8FS	1415672	196	SAC-4P-M12MST/5,0-PUR SH	1424122	290
SAC-4P-M12MR/1,5-PUR/M12FR	1415627	196	SAC-4P-M12MS FF TR VA	1431403	437	SAC-4P-M12MS/0,6-PVC/M12FR-3L	1415623	196	SAC-4P-M12MST/5,0-PUR/M12FST	1408810	290
SAC-4P-M12MR/0,6-PUR/M 8FR	1671564	194	SAC-4P-M12MS FF VA/./././	1431322	435	SAC-4P-M12MS/1,5-800/M12FR-3L	1567199	198	SAC-4P-M12MST/10,0-110	1089956	291
SAC-4P-M12MR/0,6-PUR/M12FR	1668726	194	SAC-4P-M12MS SH/././././	1697467	199	SAC-4P-M12MS/1,5-PUR/M 8FS	1693089	194	SAC-4P-M12MST/10,0-PUR	1408815	290
SAC-4P-M12MR/0,6-PUR/M12FR-3L	1668768	194	SAC-4P-M12MS-M 8FR-2L/./././	1515031	194	SAC-4P-M12MS/1,5-PUR/M12FR	1668496	194	SAC-4P-M12MST/10,0-PUR SH	1424123	290
SAC-4P-M12MR/0,6-PUR/M12FS	1668603	194	SAC-4P-M12MS-M 8FR/././././	1697085	194	SAC-4P-M12MS/1,5-PUR/M12FR-3L	1668535	194	SAC-4P-M12MST/10,0-PUR/M12FST	1408811	290
SAC-4P-M12MR/0,6-PVC/M 8FR	1415668	196	SAC-4P-M12MS-M 8FS	1519765	254	SAC-4P-M12MS/1,5-PVC/M 8FS	1415673	196	SAC-4P		

Index

Alphabetical

Type	Order No.	Page	Type	Order No.	Page	Type	Order No.	Page	Type	Order No.	Page
SAC-4PY-MS-0,6-PUR/2XF	1436217	249	SAC-5P-5,0-510/M12FSL FE	1424619	295	SAC-5P-M 8MR-M 8FR/920/...	1575945	432	SAC-5P-M12MRK/10,0-PUR PE SH	1414847	292
SAC-4PY-MS-1,5-PUR/2XF	1436220	249	SAC-5P-5,0-802/M12FR	1457199	203	SAC-5P-M 8MR-M 8FS/920/...	1575932	432	SAC-5P-M12MRK/10,0-PVC PE	1414848	293
SAC-4PY-MS-3,0-PUR/2XF	1436233	249	SAC-5P-5,0-802/M12FR-3L	1454370	203	SAC-5P-M 8MR/920/...	1575903	432	SAC-5P-M12MRK/10,0-PVC PE SH	1414849	293
SAC-4PY-MT/2XFT VP	1410632	300	SAC-5P-5,0-802/M12FS	1454422	203	SAC-5P-M 8MRB/1,5-115	1404465	200	SAC-5P-M12MRL/1,5-280 FE	1414850	294
SAC-5P-1,5-115/M 8FRB	1404475	200	SAC-5P-5,0-900/M12FSB	1507120	428	SAC-5P-M 8MRB/3,0-115	1404466	200	SAC-5P-M12MRL/1,5-290 FE	1424597	294
SAC-5P-1,5-115/M 8FSB	1404470	200	SAC-5P-5,0-920/M 8FS	1575783	432	SAC-5P-M 8MRB/5,0-115	1404467	200	SAC-5P-M12MRL/1,5-500 FE	1414852	295
SAC-5P-1,5-280/M12FRL FE	1414768	294	SAC-5P-5,0-920/M12FS	1507489	433	SAC-5P-M 8MRB/10,0-115	1404468	200	SAC-5P-M12MRL/1,5-510 FE	1424613	295
SAC-5P-1,5-280/M12FSL FE	1414772	294	SAC-5P-5,0-923/FR CAN SCO	1419035	431	SAC-5P-M 8MS DN TR	1435988	437	SAC-5P-M12MRL/3,0-280 FE	1414854	294
SAC-5P-1,5-290/M12FRL FE	1424605	294	SAC-5P-5,0-923/FS CAN SCO	1419030	431	SAC-5P-M 8MS-M 8FS/920/...	1575893	432	SAC-5P-M12MRL/3,0-290 FE	1424598	294
SAC-5P-1,5-290/M12FSL FE	1424601	294	SAC-5P-5,0-PUR/AD-2L	1435108	240	SAC-5P-M 8MS/0,3-920/M 8FS	1575822	432	SAC-5P-M12MRL/3,0-500 FE	1414856	295
SAC-5P-1,5-500/M12FRL FE	1414777	295	SAC-5P-5,0-PUR/M12FR	1669877	201	SAC-5P-M 8MS/5,0-920/M 8FS	1575835	432	SAC-5P-M12MRL/3,0-510 FE	1424614	295
SAC-5P-1,5-500/M12FSL FE	1414782	295	SAC-5P-5,0-PUR/M12FR SH	1682980	204	SAC-5P-M 8MS/1,0-920/M 8FS	1575848	432	SAC-5P-M12MRL/5,0-280 FE	1414858	294
SAC-5P-1,5-510/M12FRL FE	1424621	295	SAC-5P-5,0-PUR/M12FR-3L	1669903	201	SAC-5P-M 8MS/2,0-920	1575712	432	SAC-5P-M12MRL/5,0-290 FE	1424599	294
SAC-5P-1,5-510/M12FSL FE	1424617	295	SAC-5P-5,0-PUR/M12FR PE	1414800	292	SAC-5P-M 8MS/2,0-920/M 8FS	1575851	432	SAC-5P-M12MRL/5,0-500 FE	1414860	295
SAC-5P-1,5-802/M12FR	1457173	203	SAC-5P-5,0-PUR/M12FRK PE SH	1414801	292	SAC-5P-M 8MS/5,0-920	1575725	432	SAC-5P-M12MRL/5,0-510 FE	1424615	295
SAC-5P-1,5-802/M12FR-3L	1454367	203	SAC-5P-5,0-PUR/M12FS	1669848	201	SAC-5P-M 8MS/5,0-920/M 8FS	1575864	432	SAC-5P-M12MRL/10,0-280 FE	1414862	294
SAC-5P-1,5-802/M12FS	1454419	203	SAC-5P-5,0-PUR/M12FS SH	1682951	204	SAC-5P-M 8MS/10,0-920	1575738	432	SAC-5P-M12MRL/10,0-290 FE	1424600	294
SAC-5P-1,5-PUR/AD-2L	1435085	240	SAC-5P-5,0-PUR/M12FRK PE	1414804	292	SAC-5P-M 8MS/10,0-920/M 8FS	1575877	432	SAC-5P-M12MRL/10,0-500 FE	1414864	295
SAC-5P-1,5-PUR/M12FR	1669851	201	SAC-5P-5,0-PUR/M12FRK PE SH	1414805	292	SAC-5P-M 8MS/15,0-920	1575754	432	SAC-5P-M12MRL/10,0-510 FE	1424616	295
SAC-5P-1,5-PUR/M12FR SH	1682964	204	SAC-5P-5,0-PVC/AD-2L	1438639	241	SAC-5P-M 8MS/15,0-920/M 8FS	1575880	432	SAC-5P-M12MS CAN TR	1507816	437
SAC-5P-1,5-PUR/M12FR-3L	1669880	201	SAC-5P-5,0-PVC/M12FR	1415688	202	SAC-5P-M 8MS/920/...	1575767	432	SAC-5P-M12MS PB TR	1507803	437
SAC-5P-1,5-PUR/M12FRK PE	1414766	292	SAC-5P-5,0-PVC/M12FRK-3L	1415693	202	SAC-5P-M 8MSB/0,3-115/M 8FSB	1404479	200	SAC-5P-M12MS SH/...	1697506	204
SAC-5P-1,5-PUR/M12FRK PE SH	1414767	292	SAC-5P-5,0-PVC/M12FRK PE	1414808	293	SAC-5P-M 8MSB/0,6-115/M 8FSB	1404480	200	SAC-5P-M12MS-M12FR SH/...	1536133	204
SAC-5P-1,5-PUR/M12FS	1669822	201	SAC-5P-5,0-PVC/M12FRK PE SH	1414809	293	SAC-5P-M 8MSB/1,5-115	1404461	200	SAC-5P-M12MS-M12FR-3L/...	1697166	201
SAC-5P-1,5-PUR/M12FS SH	1682935	204	SAC-5P-5,0-PVC/M12FS	1453889	292	SAC-5P-M 8MSB/1,5-115/M 8FSB	1404481	200	SAC-5P-M12MS-M12FR/...	1697153	201
SAC-5P-1,5-PUR/M12FSK PE	1414770	292	SAC-5P-5,0-PVC/M12FSK PE	1414812	293	SAC-5P-M 8MSB/3,0-115	1404462	200	SAC-5P-M12MS-M12FR/920/...	1431102	433
SAC-5P-1,5-PUR/M12FSK PE SH	1414771	292	SAC-5P-5,0-PVC/M12FSK PE SH	1414813	293	SAC-5P-M 8MSB/3,0-115/M 8FSB	1404482	200	SAC-5P-M12MS-M12FS SH/...	1536120	204
SAC-5P-1,5-PVC/AD-2L	1415945	241	SAC-5P-10,0-115/M 8FRB	1404478	200	SAC-5P-M 8MSB/5,0-115	1404463	200	SAC-5P-M12MS-M12FS/...	1697140	201
SAC-5P-1,5-PVC/M12FR	1415686	202	SAC-5P-10,0-115/M 8FSB	1404474	200	SAC-5P-M 8MSB/10,0-115	1404464	200	SAC-5P-M12MS-M12FS/920/...	1538144	433
SAC-5P-1,5-PVC/M12FR-3L	1415690	202	SAC-5P-10,0-280/M12FRL FE	1414819	294	SAC-5P-M12FR SH/...	1697535	204	SAC-5P-M12MS/0,3-802/M12FR	1457283	203
SAC-5P-1,5-PVC/M12FRK PE	1414774	293	SAC-5P-10,0-280/M12FSL FE	1414823	294	SAC-5P-M12FR-3L/...	1697137	201	SAC-5P-M12MS/0,3-802/M12FR-3L	1457306	203
SAC-5P-1,5-PVC/M12FRK PE SH	1414775	293	SAC-5P-10,0-290/M12FRL FE	1424608	294	SAC-5P-M12FR/...	1697124	201	SAC-5P-M12MS/0,6-920/M12FS	1457267	203
SAC-5P-1,5-PVC/M12FS	1415683	202	SAC-5P-10,0-290/M12FSL FE	1424604	294	SAC-5P-M12FR/920/...	1431092	433	SAC-5P-M12MS/0,6-802/M12FR	1454516	203
SAC-5P-1,5-PVC/M12FSK PE	1414780	293	SAC-5P-10,0-500/M12FRL FE	1414827	295	SAC-5P-M12FRB/900/...	1430983	428	SAC-5P-M12MS/0,3-PUR/M12FR SH	1501003	204
SAC-5P-1,5-PVC/M12FSK PE SH	1414781	293	SAC-5P-10,0-500/M12FSL FE	1414831	295	SAC-5P-M12FS SH/...	1697522	204	SAC-5P-M12MS/0,3-PUR/M12FS SH	1500884	204
SAC-5P-1,5-PVC/M12FSB	1450717	428	SAC-5P-10,0-510/M12FRL FE	1424624	295	SAC-5P-M12FS/...	1697111	201	SAC-5P-M12MS/0,5-920/M12FS	1507531	433
SAC-5P-2,0-920/M 8FS	1575770	432	SAC-5P-10,0-510/M12FSL FE	1424620	295	SAC-5P-M12FS/920/...	1538128	433	SAC-5P-M12MS/0,6-802/M12FR	1454516	203
SAC-5P-2,0-920/M12FS	1507476	433	SAC-5P-10,0-802/M12FR	1457209	203	SAC-5P-M12FSB/900/...	1538005	428	SAC-5P-M12MS/0,6-802/M12FR-3L	1454464	203
SAC-5P-2,0-923/FR CAN SCO	1419034	431	SAC-5P-10,0-802/M12FR-3L	1454396	203	SAC-5P-M12MR SH/...	1697519	204	SAC-5P-M12MS/0,6-802/M12FS	1454561	203
SAC-5P-2,0-923/FR CAN SCO	1419081	431	SAC-5P-10,0-802/M12FS	1454448	203	SAC-5P-M12MR SH/...	1536159	204	SAC-5P-M12MS/0,6-PUR/M12FR SH	1501029	204
SAC-5P-3,0-115/M 8FRB	1404476	200	SAC-5P-10,0-900/M12FSB	1507133	428	SAC-5P-M12MR/12FR-3L/...	1552159	201	SAC-5P-M12MS/0,6-PUR/M12FS SH	1500897	204
SAC-5P-3,0-115/M 8FSB	1404471	200	SAC-5P-10,0-920/M 8FS	1575796	432	SAC-5P-M12MR/12FR/...	1529506	201	SAC-5P-M12MS/1,0-920/M12FS	1507544	433
SAC-5P-3,0-280/M12FRL FE	1414786	294	SAC-5P-10,0-920/M12FS	1507492	433	SAC-5P-M12MR SH/...	1431128	433	SAC-5P-M12MS/1,5-802	1457225	203
SAC-5P-3,0-280/M12FSL FE	1414790	294	SAC-5P-10,0-923/FR CAN SCO	1419036	431	SAC-5P-M12MR-M12FR SH/...	1536146	204	SAC-5P-M12MS/1,5-802/M12FR	1454532	203
SAC-5P-3,0-290/M12FRL FE	1424606	294	SAC-5P-10,0-923/FS CAN SCO	1419031	431	SAC-5P-M12MR-M12FS/...	1508734	201	SAC-5P-M12MS/1,5-802/M12FR-3L	1454480	203
SAC-5P-3,0-290/M12FSL FE	1424602	294	SAC-5P-10,0-PUR/AD-2L	1435111	240	SAC-5P-M12MR-M12FS/920/...	1431115	433	SAC-5P-M12MS/1,5-802/M12FR	1454587	203
SAC-5P-3,0-500/M12FRL FE	1414794	295	SAC-5P-10,0-PUR/M12FR	1694544	201	SAC-5P-M12MR/1,5-802	1457322	203	SAC-5P-M12MS/1,5-PUR SH	1682728	204
SAC-5P-3,0-500/M12FSL FE	1414798	295	SAC-5P-10,0-PUR/M12FR SH	1500761	204	SAC-5P-M12MR/1,5-PUR SH	1682757	204	SAC-5P-M12MS/1,5-PUR/M12FR SH	1501045	204
SAC-5P-3,0-510/M12FRL FE	1424622	295	SAC-5P-10,0-PUR/M12FR-3L	1694431	201	SAC-5P-M12MR/3,0-802	1457335	203	SAC-5P-M12MS/1,5-PUR/M12FS SH	1500907	204
SAC-5P-3,0-510/M12FSL FE	1424618	295	SAC-5P-10,0-PUR/M12FRK PE	1414817	292	SAC-5P-M12MR/3,0-PUR SH	1682760	204	SAC-5P-M12MS/2,0-920	1507421	433
SAC-5P-3,0-802/M12FR	1457186	203	SAC-5P-10,0-PUR/M12FRK PE SH	1414818	292	SAC-5P-M12MR/5,0-802	1457348	203	SAC-5P-M12MS/2,0-920/M12FS	1507557	433
SAC-5P-3,0-802/M12FR-3L	1457212	203	SAC-5P-10,0-PUR/M12FS	1683374	201	SAC-5P-M12MR/5,0-PUR SH	1682773	204	SAC-5P-M12MS/3,0-802	1457238	203
SAC-5P-3,0-802/M12FS	1457160	203	SAC-5P-10,0-PUR/M12FS SH	1500758	204	SAC-5P-M12MR/...	1697108	201	SAC-5P-M12MS/3,0-802/M12FR	1457296	203
SAC-5P-3,0-PUR/AD-2L	1435098	240	SAC-5P-10,0-PUR/M12FSK PE	1414821	292	SAC-5P-M12MR/1,5-PUR	1669796	201	SAC-5P-M12MS/3,0-802/M12FR-3L	1457319	203
SAC-5P-3,0-PUR/M12FR	1669864	201	SAC-5P-10,0-PUR/M12FSK PE SH	1414822	292	SAC-5P-M12MR/1,5-PVC	1415679	202	SAC-5P-M12MS/3,0-802/M12FS	1457270	203
SAC-5P-3,0-PUR/M12FR SH	1682977	204	SAC-5P-10,0-PVC/AD-2L	1438671	241	SAC-5P-M12MR/10,0-802	1457351	203	SAC-5P-M12MS/3,0-PUR SH	1682744	204
SAC-5P-3,0-PUR/M12FR-3L	1669893	201	SAC-5P-10,0-PVC/M12FR	1415689	202	SAC-5P-M12MR/10,0-PUR	1694460	201	SAC-5P-M12MS/3,0-PUR/M12FR SH	1501058	204
SAC-5P-3,0-PUR/M12FRK PE	1414784	292	SAC-5P-10,0-PVC/M12FR-3L	1415694	202	SAC-5P-M12MR/10,0-PUR SH	1500745	204	SAC-5P-M12MS/3,0-PUR/M12FS SH	1500910	204
SAC-5P-3,0-PUR/M12FRK PE SH	1414785	292	SAC-5P-10,0-PVC/M12FRK PE	1414825	293	SAC-5P-M12MR/10,0-PVC	1415682	202	SAC-5P-M12MS/5,0-802	1457241	203
SAC-5P-3,0-PUR/M12FS	1669835	201	SAC-5P-10,0-PVC/M12FRK PE SH	1414826	293	SAC-5P-M12MR/3,0-PUR	1669806	201	SAC-5P-M12MS/5,0-920	1507434	433
SAC-5P-3,0-PUR/M12FS SH	1682948	204	SAC-5P-10,0-PVC/M12FS	1415685	202	SAC-5P-M12MR/3,0-PVC	1415680	202	SAC-5P-M12MS/5,0-920/M12FS	1507560	433
SAC-5P-3,0-PUR/M12FSK PE	1414788	292	SAC-5P-10,0-PVC/M12FSK PE	1414829	293	SAC-5P-M12MR/3,0-PUR	1669819	201	SAC-5P-M12MS/5,0-PUR SH	1682731	204
SAC-5P-3,0-PUR/M12FSK PE SH	1414789	292	SAC-5P-10,0-PVC/M12FSK PE SH	1414830	293	SAC-5P-M12MR/5,0-PVC	1415681	202	SAC-5P-M12MS/...	1697098	201
SAC-5P-3,0-PVC/AD-2L	1415946	241	SAC-5P-100,0-534/0,75	1457445	304	SAC-5P-M12MR/920/...	1431089	433	SAC-5P-M12MS/0,3-PUR/M12FR	1681622	201
SAC-5P-3,0-PVC/M12FR	1415687	202	SAC-5P-100,0-PUR/0,34	1501676	302	SAC-5P-M12MRB-M12FRB/900/...	1431018	428	SAC-5P-M12MS/0,3-PUR/M12FR-3L	1694635	201
SAC-5P-3,0-PVC/M12FR-3L	1415691	202	SAC-5P-100,0-PUR/0,5	1457403	304	SAC-5P-M12MRB-M12FRB/900					

Type	Order No.	Page	Type	Order No.	Page	Type	Order No.	Page	Type	Order No.	Page
SAC-5P-M12MS/1,5-PVC/M12FR	1415701	202	SAC-5P-M12MSL/3,0-290/FSL FE	1425020	294	SAC-5PY-M2X10,0-920	1436107	434	SAC-6P-M 8MR/ 3,0-PUR SH	1522354	206
SAC-5P-M12MS/1,5-PVC/M12FR-3L	1415705	202	SAC-5P-M12MSL/3,0-500/FSL FE	1425016	295	SAC-5PY-M2X15,0-920	1436110	434	SAC-6P-M 8MR/ 5,0-PUR	1522163	205
SAC-5P-M12MS/1,5-PVC/M12FS	1415697	202	SAC-5P-M12MSL/3,0-510/FSL FE	1425024	295	SAC-5PY-M2XF VP SH	1419920	253	SAC-6P-M 8MR/ 5,0-PUR SH	1522367	206
SAC-5P-M12MS/10,0-802	1457254	203	SAC-5P-M12T2XM12 VP	1541186	253	SAC-5PY-MF-M VP SH	1438079	253	SAC-6P-M 8MR/.....	1522189	205
SAC-5P-M12MS/10,0-920	1507447	433	SAC-5P-M12Y/2XM12FS VP	1683468	253	SAC-6P- 1,5-PUR/DTFS	1415026	244	SAC-6P-M 8MR/10,0-PUR	1522176	205
SAC-5P-M12MS/10,0-920/M12FS	1507573	433	SAC-5P-M12Y/2XM12FS VP S21	1514029	253	SAC-6P- 1,5-PUR/M 8FR	1522244	205	SAC-6P-M 8MR/10,0-PUR SH	1522370	206
SAC-5P-M12MS/10,0-PUR	1683361	203	SAC-5P-MR/ 0,3-923/FR CAN SCO	1419073	431	SAC-6P- 1,5-PUR/M 8FR SH	1522448	206	SAC-6P-M 8MS SH/.....	1522338	206
SAC-5P-M12MS/10,0-PUR SH	1500732	204	SAC-5P-MR/ 0,3-923/FS CAN SCO	1419057	431	SAC-6P- 1,5-PUR/M 8FS	1522192	205	SAC-6P-M 8MS-M 8FR SH/.....	1525023	206
SAC-5P-M12MS/10,0-PVC	1415678	202	SAC-5P-MR/ 0,5-923/FR CAN SCO	1419074	431	SAC-6P- 1,5-PUR/M 8FS SH	1522396	206	SAC-6P-M 8MS-M 8FR/.....	1551930	205
SAC-5P-M12MS/15,0-920	1507450	433	SAC-5P-MR/ 0,5-923/FS CAN SCO	1419058	431	SAC-6P- 1,5-PUR/M12FRM PE SH	1414899	298	SAC-6P-M 8MS-M 8FS SH/.....	1552100	206
SAC-5P-M12MS/15,0-920/M12FS	1507586	433	SAC-5P-MR/ 1,0-923/FR CAN SCO	1419075	431	SAC-6P- 1,5-PUR/M12FRM PE SH	1414900	298	SAC-6P-M 8MS-M 8FS/.....	1551927	205
SAC-5P-M12MS/3,0-PUR	1669770	201	SAC-5P-MR/ 1,0-923/FS CAN SCO	1419059	431	SAC-6P- 1,5-PUR/M12FSM PE	1414901	298	SAC-6P-M 8MS/ 1,5-PUR	1522095	205
SAC-5P-M12MS/3,0-PUR/M12FR	1681651	201	SAC-5P-MR/ 2,0-923 CAN SCO	1419044	431	SAC-6P- 1,5-PUR/M12FSM PE SH	1414902	298	SAC-6P-M 8MS/ 1,5-PUR SH	1522299	206
SAC-5P-M12MS/3,0-PUR/M12FS	1681619	201	SAC-5P-MR/ 2,0-923/FR CAN SCO	1419076	431	SAC-6P- 1,5-PUR/M12FRM PE	1414903	299	SAC-6P-M 8MS/ 3,0-PUR	1522105	205
SAC-5P-M12MS/3,0-PVC	1415676	202	SAC-5P-MR/ 2,0-923/FS CAN SCO	1419060	431	SAC-6P- 1,5-PVC/M12FRM PE SH	1414904	299	SAC-6P-M 8MS/ 3,0-PUR SH	1522309	206
SAC-5P-M12MS/3,0-PVC/M12FR	1415702	202	SAC-5P-MR/ 5,0-923 CAN SCO	1419045	431	SAC-6P- 1,5-PVC/M12FSM PE	1414905	299	SAC-6P-M 8MS/ 5,0-PUR	1522118	205
SAC-5P-M12MS/3,0-PVC/M12FR-3L	1415706	202	SAC-5P-MR/ 5,0-923/FR CAN SCO	1419077	431	SAC-6P- 1,5-PVC/M12FSM PE SH	1414906	299	SAC-6P-M 8MS/ 5,0-PUR SH	1522312	206
SAC-5P-M12MS/3,0-PVC/M12FS	1415698	202	SAC-5P-MR/ 5,0-923/FS CAN SCO	1419061	431	SAC-6P- 3,0-PUR/DTFS	1415027	244	SAC-6P-M 8MR/ 5,0-PUR	1522134	205
SAC-5P-M12MS/5,0-PUR	1669783	201	SAC-5P-MR/10,0-923 CAN SCO	1419046	431	SAC-6P- 3,0-PUR/M 8FR	1522257	205	SAC-6P-M 8MS/10,0-PUR	1522121	205
SAC-5P-M12MS/5,0-PVC	1415677	202	SAC-5P-MR/10,0-923/FR CAN SCO	1419078	431	SAC-6P- 3,0-PUR/M 8FR SH	1522451	206	SAC-6P-M 8MS/10,0-PUR SH	1522325	206
SAC-5P-M12MS/920/...	1538102	423	SAC-5P-MR/10,0-923/FS CAN SCO	1419062	431	SAC-6P- 3,0-PUR/M 8FS	1522202	205	SAC-6P-M12FR-PURMC/	1520987	311
SAC-5P-M12MSB-M12FRB/900/...	1430996	428	SAC-5P-MR/15,0-923 CAN SCO	1419047	431	SAC-6P- 3,0-PUR/M 8FS SH	1522406	206	SAC-6P-M12MRM/ 1,5-PUR PE	1414932	298
SAC-5P-M12MSB-M12FSB/900/...	1538021	428	SAC-5P-MR/15,0-923/FR CAN SCO	1419079	431	SAC-6P- 3,0-PUR/M12FRM PE	1414907	298	SAC-6P-M12MRM/ 1,5-PUR PE SH	1414933	298
SAC-5P-M12MSB/ 0,3-900/M12FSB	1507162	428	SAC-5P-MR/15,0-923/FS CAN SCO	1419063	431	SAC-6P- 3,0-PUR/M12FRM PE SH	1414908	298	SAC-6P-M12MRM/ 1,5-PVC PE	1414934	299
SAC-5P-M12MSB/ 0,5-900/M12FSB	1507175	428	SAC-5P-MR/20,0-923 CAN SCO	1419048	431	SAC-6P- 3,0-PUR/M12FSM PE	1414910	298	SAC-6P-M12MRM/ 1,5-PUR PE SH	1414935	299
SAC-5P-M12MSB/ 1,0-900/M12FSB	1507188	428	SAC-5P-MR/20,0-923/FR CAN SCO	1419080	431	SAC-6P- 3,0-PUR/M12FSM PE SH	1414911	298	SAC-6P-M12MRM/ 3,0-PUR PE	1414936	298
SAC-5P-M12MSB/ 2,0-900	1507065	428	SAC-5P-MR/20,0-923/FS CAN SCO	1419064	431	SAC-6P- 3,0-PVC/M12FRM PE	1414912	299	SAC-6P-M12MRM/ 3,0-PUR PE SH	1414937	298
SAC-5P-M12MSB/ 2,0-900/M12FSB	1507191	428	SAC-5P-MR/AD-2L SCO	1458606	256	SAC-6P- 3,0-PVC/M12FRM PE SH	1414913	299	SAC-6P-M12MRM/ 3,0-PVC PE	1414939	299
SAC-5P-M12MSB/ 5,0-900	1507078	428	SAC-5P-MS-AD-2L SCO/.....	1435072	240	SAC-6P- 3,0-PVC/M12FSM PE	1414914	299	SAC-6P-M12MRM/ 3,0-PVC PE SH	1414940	299
SAC-5P-M12MSB/ 5,0-900/M12FSB	1507201	428	SAC-5P-MS/ 0,3-923/FR CAN SCO	1419065	431	SAC-6P- 3,0-PVC/M12FSM PE SH	1414915	299	SAC-6P-M12MRM/ 5,0-PUR PE	1414941	298
SAC-5P-M12MSB/10,0-900	1507081	428	SAC-5P-MS/ 0,3-923/FS CAN SCO	1419049	431	SAC-6P- 3,0-PUR/DTFS	1415028	244	SAC-6P-M12MRM/ 5,0-PUR PE SH	1414942	298
SAC-5P-M12MSB/10,0-900/M12FSB	1507214	428	SAC-5P-MS/ 0,3-PUR/AD-2L SCO	1435030	240	SAC-6P- 3,0-PUR/M 8FR	1522260	205	SAC-6P-M12MRM/ 5,0-PVC PE	1414943	299
SAC-5P-M12MSB/15,0-900	1507094	428	SAC-5P-MS/ 0,5-923/FR CAN SCO	1419066	431	SAC-6P- 5,0-PUR/M 8FR SH	1522464	206	SAC-6P-M12MRM/ 5,0-PVC PE SH	1414944	299
SAC-5P-M12MSB/15,0-900/M12FSB	1507227	428	SAC-5P-MS/ 0,5-923/FS CAN SCO	1419050	431	SAC-6P- 5,0-PUR/M 8FS	1522215	205	SAC-6P-M12MRM/10,0-PUR PE	1414945	298
SAC-5P-M12MSB/900/...	1537983	428	SAC-5P-MS/ 0,6-PUR/AD-2L SCO	1435043	240	SAC-6P- 5,0-PUR/M 8FS SH	1522419	206	SAC-6P-M12MRM/10,0-PUR PE SH	1414946	298
SAC-5P-M12MSK/ 1,5-PUR PE	1414866	292	SAC-5P-MS/ 1,0-923/FR CAN SCO	1419067	431	SAC-6P- 5,0-PUR/M12FRM PE	1414916	298	SAC-6P-M12MRM/10,0-PVC PE	1414947	299
SAC-5P-M12MSK/ 1,5-PUR PE SH	1414867	292	SAC-5P-MS/ 1,0-923/FS CAN SCO	1419051	431	SAC-6P- 5,0-PUR/M12FRM PE SH	1414917	298	SAC-6P-M12MRM/10,0-PVC PE SH	1414948	299
SAC-5P-M12MSK/ 1,5-PVC PE	1414868	293	SAC-5P-MS/ 1,5-PUR/AD-2L SCO	1435056	240	SAC-6P- 5,0-PUR/M12FSM PE	1414918	298	SAC-6P-M12MSM/ 1,5-PUR PE	1414949	298
SAC-5P-M12MSK/ 1,5-PVC PE SH	1414869	293	SAC-5P-MS/ 2,0-923 CAN SCO	1419039	431	SAC-6P- 5,0-PUR/M12FSM PE SH	1414919	298	SAC-6P-M12MSM/ 1,5-PUR PE SH	1414950	298
SAC-5P-M12MSK/ 3,0-PUR PE	1414870	292	SAC-5P-MS/ 2,0-923/FR CAN SCO	1419068	431	SAC-6P- 5,0-PUR/M12FRM PE	1407820	311	SAC-6P-M12MSM/ 1,5-PVC PE	1414951	299
SAC-5P-M12MSK/ 3,0-PUR PE SH	1414871	292	SAC-5P-MS/ 2,0-923/FS CAN SCO	1419052	431	SAC-6P- 5,0-PVC/M12FRM PE	1414920	299	SAC-6P-M12MSM/ 1,5-PVC PE SH	1414952	299
SAC-5P-M12MSK/ 3,0-PVC PE	1414872	293	SAC-5P-MS/ 3,0-PUR/AD-2L SCO	1435059	240	SAC-6P- 5,0-PVC/M12FRM PE SH	1414921	299	SAC-6P-M12MSM/ 3,0-PUR PE	1414953	298
SAC-5P-M12MSK/ 3,0-PVC PE SH	1414873	293	SAC-5P-MS/ 5,0-923 CAN SCO	1419040	431	SAC-6P- 5,0-PVC/M12FSM PE	1414922	299	SAC-6P-M12MSM/ 3,0-PUR PE SH	1414954	298
SAC-5P-M12MSK/ 5,0-PUR PE	1414875	292	SAC-5P-MS/ 5,0-923/FR CAN SCO	1419069	431	SAC-6P- 5,0-PVC/M12FSM PE SH	1414923	299	SAC-6P-M12MSM/ 3,0-PVC PE	1414955	299
SAC-5P-M12MSK/ 5,0-PUR PE SH	1414876	292	SAC-5P-MS/ 5,0-923/FS CAN SCO	1419053	431	SAC-6P-10,0-PUR/DTFS	1415029	244	SAC-6P-M12MSM/ 3,0-PVC PE SH	1414956	299
SAC-5P-M12MSK/ 5,0-PVC PE	1414877	293	SAC-5P-MS/10,0-923 CAN SCO	1419041	431	SAC-6P-10,0-PUR/M 8FR	1522273	205	SAC-6P-M12MSM/ 5,0-PUR PE	1414957	298
SAC-5P-M12MSK/ 5,0-PVC PE SH	1414878	293	SAC-5P-MS/10,0-923/FR CAN SCO	1419070	431	SAC-6P-10,0-PUR/M 8FR SH	1522477	206	SAC-6P-M12MSM/ 5,0-PUR PE SH	1414958	298
SAC-5P-M12MSK/10,0-PUR PE	1414879	292	SAC-5P-MS/10,0-923/FS CAN SCO	1419054	431	SAC-6P-10,0-PUR/M 8FS	1522228	205	SAC-6P-M12MSM/ 5,0-PVC PE	1414959	299
SAC-5P-M12MSK/10,0-PUR PE SH	1414880	292	SAC-5P-MS/15,0-923 CAN SCO	1419042	431	SAC-6P-10,0-PUR/M 8FS SH	1522422	206	SAC-6P-M12MSM/ 5,0-PVC PE SH	1414960	299
SAC-5P-M12MSK/10,0-PVC PE	1414881	293	SAC-5P-MS/15,0-923/FR CAN SCO	1419071	431	SAC-6P-10,0-PUR/M12FRM PE	1414924	298	SAC-6P-M12MSM/10,0-PUR PE	1414961	298
SAC-5P-M12MSK/10,0-PVC PE SH	1414882	293	SAC-5P-MS/15,0-923/FS CAN SCO	1419055	431	SAC-6P-10,0-PUR/M12FRM PE SH	1414925	298	SAC-6P-M12MSM/10,0-PUR PE SH	1414962	298
SAC-5P-M12MSL/ 1,5-280 FE	1414883	294	SAC-5P-MS/20,0-923 CAN SCO	1419043	431	SAC-6P-10,0-PUR/M12FSM PE	1414926	298	SAC-6P-M12MSM/10,0-PVC PE	1414963	299
SAC-5P-M12MSL/ 1,5-290 FE	1424593	294	SAC-5P-MS/20,0-923/FR CAN SCO	1419072	431	SAC-6P-10,0-PUR/M12FSM PE SH	1414927	298	SAC-6P-M12MSM/10,0-PVC PE SH	1414964	299
SAC-5P-M12MSL/ 1,5-500 FE	1414885	295	SAC-5P-MS/20,0-923/FS CAN SCO	1419056	431	SAC-6P-10,0-PUR/M12FRM PE	1407821	311	SAC-8P- 1,5-PUR/M 8FR	1404191	207
SAC-5P-M12MSL/ 1,5-510 FE	1424609	295	SAC-5P-MS/AD-2L SCO	1458596	256	SAC-6P-10,0-PVC/M12FRM PE	1414928	299	SAC-8P- 1,5-PUR/M 8FS	1404187	207
SAC-5P-M12MSL/ 3,0-280 FE	1414887	294	SAC-5P-PUR-0,34-SH/...	1408515	303	SAC-6P-10,0-PVC/M12FRM PE SH	1414929	299	SAC-8P- 1,5-PUR/M 8FS SH	1404147	210
SAC-5P-M12MSL/ 3,0-290 FE	1424594	294	SAC-5P-PUR-0,34/...	1408509	303	SAC-6P-10,0-PVC/M12FSM PE	1414930	299	SAC-8P- 1,5-PUR/M12FR	1522826	208
SAC-5P-M12MSL/ 3,0-500 FE	1414889	295	SAC-5P-PUR-0,5/...	1408530	304	SAC-6P-10,0-PVC/M12FSM PE SH	1414931	299	SAC-8P- 1,5-PUR/M12FR SH	1522914	211
SAC-5P-M12MSL/ 3,0-510 FE	1424610	295	SAC-5P-PVC-0,34-SH/...	1408527	303	SAC-6P-100,0-PUR/0,25	1550614	302	SAC-8P- 1,5-PUR/M12FS	1522590	208
SAC-5P-M12MSL/ 5,0-280 FE	1414891	294	SAC-5P-PVC-0,34/...	1408523	303	SAC-6P-100,0-PUR/SH-0,14	1550627	303	SAC-8P- 1,5-PUR/M12FS SH	1522862	211
SAC-5P-M12MSL/ 5,0-290 FE	1424595	294	SAC-5PY-2XFS VP SCO	1546068	253	SAC-6P-DTMS/ 0,3-PUR/DTFS	1415035	244	SAC-8P- 1,5-PVC/M12FR	1415732	209
SAC-5P-M12MSL/ 5,0-500 FE	1414893	295	SAC-5PH-M-FI2XF SH1 SCO	1417414	436	SAC-6P-DTMS/ 0,6-PUR/DTFS	1415036	244	SAC-8P- 3,0-PUR/M12FR	1415724	209
SAC-5P-M12MSL/ 5,0-510 FE	1424611	295	SAC-5PT-F/F-M VP	1424712	253	SAC-6P-DTMS/ 1,5-PUR	1415030	244	SAC-8P- 3,0-PUR/M 8FR	1404192	207
SAC-5P-M12MSL/3,0-280/FSL FE	1425009	294	SAC-5PT-FB/2XMB PBDP SH	1424711	436	SAC-6P-DTMS/ 1,5-PUR/DTFS	1415037	244	SAC-8P- 3,0-PUR/M 8FS	1404188	207
SAC-5P-M12MSL/3,0-290/FSL FE	1425017	294	SAC-5PT-FB/MB-MBF PBDP SH	1424713	436	SAC-6P-DTMS/ 3,0-PUR	1415031	244	SAC-8P- 3,0-PUR/M 8FS SH	1404148	210
SAC-5P-M1											

Index

Alphabetical

Type	Order No.	Page	Type	Order No.	Page	Type	Order No.	Page	Type	Order No.	Page
SAC-8P-5,0-PVC/M12FR	1415735	209	SAC-8P-M12MS/0,6-PVC/M12FS	1415738	209	SACB-6/3-C QO-0,34	1548367	266	SACB-4/ 8-L-C GG SCO P	1452877	263
SAC-8P-5,0-PVC/M12FS	1415726	209	SAC-8P-M12MS/1,5-PUR	1522493	208	SACB-6/3-L-5,0PUR-M8	1516030	260	SACB-4/ 8-L-C NPN SCO	1537103	264
SAC-8P-10,0-PUR/M 8FR	1404194	207	SAC-8P-M12MS/1,5-PUR SH	1522778	211	SACB-6/3-L-10,0PUR-M8	1516043	260	SACB-4/ 8-L-C SCO	1516797	264
SAC-8P-10,0-PUR/M 8FS	1404190	207	SAC-8P-M12MS/1,5-PUR/M12FR	1522749	208	SACB-6/3-L-C QO-0,34	1548338	266	SACB-4/ 8-L-C SCO P	1452819	263
SAC-8P-10,0-PUR/M 8FS SH	1404150	210	SAC-8P-M12MS/1,5-PUR/M12FR SH	1523036	211	SACB-6/3-L-C-M8	1503425	261	SACB-4/ 8-L-PT SCO P	1412058	262
SAC-8P-10,0-PUR/M12FR	1522655	208	SAC-8P-M12MS/1,5-PUR/M12FS	1522697	208	SACB-6/3-L-C-M8 GG	1516263	261	SACB-4/ 8-L-SC SCO P	1452990	262
SAC-8P-10,0-PUR/M12FR SH	1522943	211	SAC-8P-M12MS/1,5-PUR/M12FS SH	1522985	211	SACB-6/3-L-M12-M8	1516247	260	SACB-4/ 8-SC SCO P	1452932	262
SAC-8P-10,0-PUR/M12FS	1520372	208	SAC-8P-M12MS/1,5-PVC	1415716	209	SACB-6/3-L-M16-M8	1516195	261	SACB-4/T-L-8FUSE CT AXL	1413929	301
SAC-8P-10,0-PUR/M12FS SH	1522891	211	SAC-8P-M12MS/1,5-PVC/M12FR	1415747	209	SACB-6/3-L-SC-M8	1503399	261	SACB-4/T-L-8FUSE DIAG CT AXL	1411048	301
SAC-8P-10,0-PUR/M16FR	1693694	311	SAC-8P-M12MS/1,5-PVC/M12FS	1415739	209	SACB-6/4-C QO-0,34	1548222	266	SACB-4Q/4P-5,0PUR	1683662	267
SAC-8P-10,0-PUR/MC/M12FR	1407823	311	SAC-8P-M12MS/3,0-PUR	1522503	208	SACB-6/4-L-C QO-0,34	1548396	266	SACB-4Q/4P-10,0PUR	1683675	267
SAC-8P-10,0-PVC/M12FR	1415736	209	SAC-8P-M12MS/3,0-PUR SH	1522781	211	SACB-6X0,34/3X0,75-50,0 PUR	1503331	305	SACB-4Q/4P-L-5,0PUR	1695223	267
SAC-8P-10,0-PVC/M12FS	1415727	209	SAC-8P-M12MS/3,0-PUR/M12FR	1522752	208	SACB-6X0,34/2X0,75-50 PUR	1517589	305	SACB-4Q/4P-L-10,0PUR	1695236	267
SAC-8P-100,0-PUR/0,25	1550630	302	SAC-8P-M12MS/3,0-PUR/M12FR SH	1523049	211	SACB-8/3-C QO-0,34	1548370	266	SACB-4Q/4P-L-SC	1662939	267
SAC-8P-100,0-PUR/SH/0,25	1550643	303	SAC-8P-M12MS/3,0-PUR/M12FS	1522707	208	SACB-8/3-L-5,0PUR QO-0,34	1548480	266	SACB-4Q/4P-L-SC NPN	1680856	267
SAC-8P-100,0-PVC/0,25	1550698	302	SAC-8P-M12MS/3,0-PUR/M12FS SH	1522998	211	SACB-8/3-L-5,0PUR-M8	1516056	260	SACB-4Q/4P-SC	1683633	267
SAC-8P-100,0-PVC/SH/0,25	1550708	303	SAC-8P-M12MS/3,0-PVC	1415717	209	SACB-8/3-L-10,0PUR QO-0,34	1548493	266	SACB-6/ 6-5,0PUR SCO	1517000	264
SAC-8P-M 8MS/1,5-PUR	1404182	207	SAC-8P-M12MS/3,0-PVC/M12FR	1415748	209	SACB-8/3-L-10,0PUR-M8	1516069	260	SACB-6/ 6-5,0PUR SCO P	1452453	262
SAC-8P-M 8MR/3,0-PUR	1404186	207	SAC-8P-M12MS/3,0-PVC/M12FS	1415740	209	SACB-8/3-L-C QO-0,34	1548341	266	SACB-6/ 6-10,0PUR SCO	1517013	264
SAC-8P-M 8MR/5,0-PUR	1404185	207	SAC-8P-M12MS/5,0-PUR	1522516	211	SACB-8/3-L-C-M8	1511750	261	SACB-6/ 6-10,0PUR SCO P	1452466	262
SAC-8P-M 8MR/10,0-PUR	1404183	207	SAC-8P-M12MS/5,0-PUR SH	1526981	211	SACB-8/3-L-C-M8 GG	1516276	261	SACB-6/ 6-C SCO	1516865	264
SAC-8P-M 8MS/0,3-PUR/M 8FR	1404201	207	SAC-8P-M12MS/5,0-PVC	1415718	209	SACB-8/3-L-M12-M8	1434840	260	SACB-6/ 6-C SCO P	1452767	263
SAC-8P-M 8MS/0,3-PUR/M 8FS	1404196	207	SAC-8P-M12MS/...	1522532	208	SACB-8/3-L-M16-M8	1516205	261	SACB-6/ 6-L-5,0PUR SCO	1517123	264
SAC-8P-M 8MS/0,3-PUR/M 8FS SH	1404133	210	SAC-8P-M12MS/10,0-PUR	1522529	208	SACB-8/3-L-SC-M8	1511747	261	SACB-6/ 6-L-5,0PUR SCO P	1452631	262
SAC-8P-M 8MS/0,6-PUR/M 8FR	1404202	207	SAC-8P-M12MS/10,0-PUR SH	1522794	211	SACB-8/4-C QO-0,34	1548435	266	SACB-6/ 6-L-10,0PUR SCO	1517136	264
SAC-8P-M 8MS/0,6-PUR/M 8FS	1404198	207	SAC-8P-M12MS/10,0-PVC	1415719	209	SACB-8/4-L-5,0PUR QO-0,34	1548574	266	SACB-6/ 6-L-10,0PUR SCO P	1452644	262
SAC-8P-M 8MS/0,6-PUR/M 8FS SH	1404134	210	SAC-8P-PUR-0,25-SH/...	1408516	303	SACB-8/4-L-5,0PUR-M8	1516111	260	SACB-6/ 6-L-C GG SCO	1516742	265
SAC-8P-M 8MS/1,5-PUR	1404178	207	SAC-8P-PUR-0,25-...	1408510	303	SACB-8/4-L-10,0PUR QO-0,34	1548587	266	SACB-6/ 6-L-C GG SCO P	1452880	263
SAC-8P-M 8MS/1,5-PUR SH	1404137	210	SAC-8P-PVC-0,25-SH/...	1408528	303	SACB-8/4-L-10,0PUR-M8	1516124	260	SACB-6/ 6-L-C NPN SCO	1537080	264
SAC-8P-M 8MS/1,5-PUR/M 8FR	1404203	207	SAC-8P-PVC-0,25-...	1408524	303	SACB-8/4-L-C QO-0,34	1548406	266	SACB-6/ 6-L-C SCO	1516807	264
SAC-8P-M 8MS/1,5-PUR/M 8FS	1404199	207	SAC-8PY-M/2XF VP	1454972	253	SACB-8/4-L-C-M8	1503467	261	SACB-6/ 6-L-C SCO P	1452822	262
SAC-8P-M 8MS/1,5-PUR/M 8FS SH	1404135	210	SAC-8PY-M/2XF VP SH	1454969	253	SACB-8/4-L-SC-M8	1503454	261	SACB-6/ 6-L-SC SCO P	1453009	263
SAC-8P-M 8MS/3,0-PUR	1404180	207	SAC-8PY-MY/M-FD SH	1410630	436	SACB-8X0,34/3X0,75-50,0 PUR	1503344	305	SACB-6/ 6-SC SCO P	1452945	262
SAC-8P-M 8MS/3,0-PUR SH	1404140	207	SAC-ASI-JY-B-FFKDS	1407579	439	SACB-8X0,34/2X0,75-50 PUR	1517592	305	SACB-6/12-5,0HPUR SCO	1517220	264
SAC-8P-M 8MS/3,0-PUR/M 8FR	1404204	210	SAC-ASI-JY-B-M12FS	1405621	440	SACB-8X0,5/3X1,0-50,0 PUR	1503357	305	SACB-6/12-5,0PUR SCO	1517026	264
SAC-8P-M 8MS/3,0-PUR/M 8FS	1404200	207	SAC-ASI-JY-B-PUR-1,0-FR SCO	1407577	439	SACB-10/3-L-5,0PUR-M8	1516072	260	SACB-6/12-5,0PUR SCO P	1452482	262
SAC-8P-M 8MS/3,0-PUR/M 8FS SH	1404136	210	SAC-ASI-JY-B-PUR-1,0-FS SCO	1407575	439	SACB-10/3-L-10,0PUR-M8	1516085	260	SACB-6/12-10,0HPUR SCO	1517233	264
SAC-8P-M 8MS/5,0-PUR	1404181	207	SAC-ASI-JY-B-PUR-2,0-FR SCO	1407578	439	SACB-10/3-L-C-M8	1503438	261	SACB-6/12-10,0PUR SCO	1517039	264
SAC-8P-M 8MS/5,0-PUR SH	1404141	210	SAC-ASI-JY-B-PUR-2,0-FS SCO	1407576	439	SACB-10/3-L-C-M8 GG	1516289	261	SACB-6/12-10,0PUR SCO P	1452495	262
SAC-8P-M 8MS/10,0-PUR	1404179	207	SAC-ASI-JY-B-PUR-2,0-OE	1407581	439	SACB-10/3-L-M12-M8	1434853	260	SACB-6/12-C SCO	1516878	264
SAC-8P-M 8MS/10,0-PUR SH	1404138	210	SAC-ASI-JY-N-M12FS	1405619	440	SACB-10/3-L-M16-M8	1516218	261	SACB-6/12-C SCO P	1452770	263
SAC-8P-M12FR SH/...	1522956	211	SAC-ASI-JY-N-PUR-1,0-FS SCO	1407573	439	SACB-10/3-L-SC-M8	1503409	261	SACB-6/12-L-5,0HPUR SCO	1517288	264
SAC-8P-M12FR-PUR/MC/...	1520990	311	SAC-ASI-JY-N-PUR-2,0-FS SCO	1407574	439	SACB-10X0,34/2X0,75-50 PUR	1517602	305	SACB-6/12-L-5,0PUR SCO	1517149	264
SAC-8P-M12FR/...	1522668	208	SAC-ASI-JY-N-PUR-2,0-OE	1407580	439	SACB-12X0,5/3X1,0-50,0 PUR	1503360	305	SACB-6/12-L-5,0PUR SCO P	1452660	262
SAC-8P-M12FS SH/...	1522901	211	SAC-ASI-JY-Y-N	1405622	439	SACB-16X0,34/2X0,75-50 PUR	1539350	305	SACB-6/12-L-10,0HPUR SCO	1517291	264
SAC-8P-M12FS/...	1522613	208	SAC-MR/0,1-116/2XA-1L-Z SCO	1458130	258	SACB-16X0,5/3X1,0-200,0 PUR	1559983	305	SACB-6/12-L-10,0PUR SCO	1517152	264
SAC-8P-M12MR SH/...	1522859	211	SAC-MR/0,1-116/2XB-1L-Z SCO	1458318	259	SACB-16X0,5/3X1,0-50,0 80MC	1402304	305	SACB-6/12-L-10,0PUR SCO P	1452673	262
SAC-8P-M12MR-M12FR SH/...	1552007	211	SAC-MR/0,1-116/2XBI-1L-Z SCO	1458499	259	SACB-16X0,5/3X1,0-50,0 PUR	1503373	305	SACB-6/12-L-C GG SCO	1516755	265
SAC-8P-M12MR-M12FR/...	1551972	208	SAC-MR/0,15-116/2XA-1L-Z SCO	1458143	258	SACB-16X0,5/3X1,0-50,0 VPUR	1430938	305	SACB-6/12-L-C GG SCO P	1452893	263
SAC-8P-M12MR-M12FS SH/...	1551998	211	SAC-MR/0,15-116/2XB-1L-Z SCO	1458321	259	SACB-16X0,5/3X1,0-50 PUR SH	1539156	305	SACB-6/12-L-C NPN SCO	1537116	264
SAC-8P-M12MR-M12FS/...	1551969	208	SAC-MR/0,15-116/2XBI-1L-Z SCO	1458509	259	SACB-4/ 4-5,0PUR SCO	1516962	264	SACB-6/12-L-C SCO	1516810	264
SAC-8P-M12MR/1,5-PUR	1522545	208	SAC-MR/0,2-116/2XA-1L-Z SCO	1458156	258	SACB-4/ 4-5,0PUR SCO P	1452398	262	SACB-6/12-L-C SCO P	1452835	263
SAC-8P-M12MR/1,5-PUR SH	1522817	211	SAC-MR/0,2-116/2XB-1L-Z SCO	1458334	259	SACB-4/ 4-10,0PUR SCO	1516975	264	SACB-6/12-L-PT SCO P	1412059	262
SAC-8P-M12MR/1,5-PVC	1415720	209	SAC-MR/0,2-116/2XBI-1L-Z SCO	1458512	259	SACB-4/ 4-C SCO	1516849	264	SACB-6/12-L-SC SCO P	1453012	262
SAC-8P-M12MR/3,0-PUR	1522558	208	SAC-MS/0,1-116/2XA-1L-Z SCO	1458101	258	SACB-4/ 4-C SCO P	1452741	263	SACB-6/12-SC SCO P	1452958	262
SAC-8P-M12MR/3,0-PUR SH	1522820	211	SAC-MS/0,1-116/2XB-1L-Z SCO	1458282	259	SACB-4/ 4-L-5,0PUR SCO	1517084	264	SACB-6Q/4P-5,0PUR	1683688	267
SAC-8P-M12MR/3,0-PVC	1415721	209	SAC-MS/0,1-116/2XBI-1L-Z SCO	1458460	259	SACB-4/ 4-L-5,0PUR SCO P	1452576	262	SACB-6Q/4P-10,0PUR	1683691	267
SAC-8P-M12MR/5,0-PUR	1522561	208	SAC-MS/0,15-116/2XA-1L-Z SCO	1458114	258	SACB-4/ 4-L-10,0PUR SCO	1517097	264	SACB-6Q/4P-L-5,0PUR	1695252	267
SAC-8P-M12MR/5,0-PUR SH	1522833	211	SAC-MS/0,15-116/2XB-1L-Z SCO	1458295	259	SACB-4/ 4-L-10,0PUR SCO P	1452589	262	SACB-6Q/4P-L-10,0PUR	1695265	267
SAC-8P-M12MR/5,0-PVC	1415722	209	SAC-MS/0,15-116/2XBI-1L-Z SCO	1458473	259	SACB-4/ 4-L-C GG SCO	1516726	265	SACB-6Q/4P-L-SC	1662942	267
SAC-8P-M12MR/...	1522587	208	SAC-MS/0,2-116/2XA-1L-Z SCO	1458127	258	SACB-4/ 4-L-C GG SCO P	1452864	263	SACB-6Q/4P-L-SC NPN	1680869	267
SAC-8P-M12MR/10,0-PUR	1522574	208	SAC-MS/0,2-116/2XB-1L-Z SCO	1458305	259	SACB-4/ 4-L-C NPN SCO	1537077	264	SACB-6Q/4P-SC	1683646	267
SAC-8P-M12MR/10,0-PUR SH	1522846	211	SAC-MS/0,2-116/2XBI-1L-Z SCO	1458486	259	SACB-4/ 4-L-C SCO	1516784	264	SACB-8/ 8-5,0PUR SCO	1517042	264
SAC-8P-M12MR/10,0-PVC	1415723	209	SACB-4/3-C QO-0,34	1548354	266	SACB-4/ 4-L-C SCO P	1452806	263	SACB-8/ 8-5,0PUR SCO P	1452518	262
SAC-8P-M12MS SH/...	1522804	211	SACB-4/3-L-5,0PUR QO-0,34	1548448	266	SACB-4/ 4-L-SC SCO P	1452987	262	SACB-8/ 8-10,0PUR SCO	1517055	264
SAC-8P-M12MS-M12FR SH/...	1523052	211	SACB-4/3-L-5,0PUR-M8	1516014	260	SACB-4/ 4-SC SCO P	1452929	262	SACB-8/ 8-10,0PUR SCO P	1452521	262
SAC-8P-M12MS-M12FR/...	1522765	208	SACB-4/3-L-10,0PUR QO-0,34	1548451	266	SACB-4/ 8-5,0HPUR SCO	1517204	264	SACB-8/ 8-C SCO	1516881	264
SAC-8P-M12MS-M12FS SH/...	1523007	211	SACB-4/3-L-10,0PUR-M8	1516027	260	SACB-4/ 8-5,0PUR SCO	1516988	264	SACB-8/ 8-C SCO P	1452783	263
SAC-8P-M12MS-M12FS/...	1522710	208	SACB-4/3-L-C QO-0,34	1548325	261	SACB-4/ 8-5					

Type	Order No.	Page	Type	Order No.	Page	Type	Order No.	Page
SACB-8/ 8-L-SC SCO P	1453025	262	SACC-5P-DSH-M12MS/FS-M16	1551671	53	SACC-DSI-M12MST-4P-M16XL0,5	1411604	283
SACB-8/ 8-SC SCO P	1452961	262	SACC-5P-DSH-M12MSB/FSB-M16	1551684	53	SACC-DSI-M8FS-3CON-M10/0,5	1456080	34
SACB-8/16- 5,0HPUR SCO	1517246	264	SACC-8P-DSI-M12MS/FS-M16	1551697	53	SACC-DSI-M8FS-4CON-M10/0,5	1456093	34
SACB-8/16- 5,0PUR SCO	1517068	264	SACC-CC-2QO SH PB	1420426	423	SACC-DSI-M8FS-6CON-M10/0,5	1456103	34
SACB-8/16- 5,0PUR SCO P	1452547	262	SACC-CC-4QO SH ETH	1414415	343	SACC-DSI-M8FS-8CON-M10/0,5	1424229	34
SACB-8/16-L- 10,0PUR SCO	1517259	264	SACC-CC-4QO SH PN	1414416	343	SACC-DSI-M8MS-8CON-M8/0,5	1424230	34
SACB-8/16-L- 10,0HPUR SCO	1517071	264	SACC-CC-4QO-0,75 SH	1414418	21	SACC-DSI-MS-12CON-M12/0,5 SCO	1437122	47
SACB-8/16-L- 10,0PUR SCO P	1452550	262	SACC-CC-5QO-0,75 SH	1414417	21	SACC-DSI-MS-12CON-PG9/0,5 SCO	1430459	46
SACB-8/16-C SCO	1516894	264	SACC-CC-8QO SH ETH	1414412	342	SACC-DSI-MS-17CON-M12/0,5 SCO	1437135	47
SACB-8/16-C SCO P	1452796	263	SACC-CC-8QO-0,5 SH	1414612	21	SACC-DSI-MS-17CON-PG9/0,5 SCO	1430475	46
SACB-8/16-L- 5,0HPUR SCO	1517301	264	SACC-DSI-FS-12CON-PG9/0,5 SCO	1430446	46	SACC-DSI-MS-4CON-M12/0,5 SCO	1551875	47
SACB-8/16-L- 5,0PUR SCO	1517181	264	SACC-DSI-FS-17CON-PG9/0,5 SCO	1430462	46	SACC-DSI-MS-4CON-PG9/0,5 SCO	1556618	46
SACB-8/16-L- 5,0PUR SCO P	1452725	262	SACC-DSI-FS-4CON-PG9/0,5 SCO	1556621	46	SACC-DSI-MS-5CON-M12/0,5 SCO	1551888	47
SACB-8/16-L- 5,0PUR SCO P NPN	1405739	262	SACC-DSI-FS-5CON-M16/0,5 PP	1027666	48	SACC-DSI-MS-5CON-PG 9/0,5 SCO	1542703	46
SACB-8/16-L- 10,0HPUR SCO	1517314	264	SACC-DSI-FS-5CON-PG 9/0,5 SCO	1542729	46	SACC-DSI-MS-8CON-M12/0,5 SCO	1551914	47
SACB-8/16-L- 10,0PUR SCO	1517194	264	SACC-DSI-FS-8CON-PG 9/0,5 SCO	1542732	46	SACC-DSI-MS-8CON-PG 9/0,5 SCO	1542716	46
SACB-8/16-L- 10,0PUR SCO P	1452738	262	SACC-DSI-FSB-5CON-PG9/ 0,5 SCO	1543676	46	SACC-DSI-MSB-5CON-M12/0,5 SCO	1551891	47
SACB-8/16-L- 10,0PUR SCO P NPN	1405740	262	SACC-DSI-FSD-4CON-M16/0,5 PP	1027670	48	SACC-DSI-MSB-5CON-PG9/ 0,5 SCO	1543663	46
SACB-8/16-L-C GG SCO	1516771	265	SACC-DSI-FSD-4CON-PG9/0,5 SCO	1551529	46	SACC-DSI-MSD-4CON-M12/0,5 SCO	1551901	47
SACB-8/16-L-C GG SCO P	1452916	263	SACC-DSI-M 8FS-3CON-M12/0,5	1453449	34	SACC-DSI-MSD-4CON-PG9/0,5 SCO	1551532	46
SACB-8/16-L-C NPN SCO	1537129	264	SACC-DSI-M 8FS-4CON-M12/0,5	1453452	34	SACC-E-FS-12CON-M16/0,5 SCO	1556252	37
SACB-8/16-L-C SCO	1516836	264	SACC-DSI-M 8FS-6CON-M12/0,5	1453465	34	SACC-E-FS-17CON-M16/0,5 SCO	1556294	37
SACB-8/16-L-C SCO OTB	1437232	265	SACC-DSI-M 8MS-3CON-M 8/0,5	1453478	34	SACC-E-FS-4CON-M16/0,5 SCO	1523434	37
SACB-8/16-L-C SCO P	1452851	263	SACC-DSI-M 8MS-4CON-M 8/0,5	1453481	34	SACC-E-FS-5CON-M16/0,5 PP	1027683	36
SACB-8/16-L-PT SCO P	1412060	262	SACC-DSI-M 8MS-6CON-M 8/0,5	1453494	34	SACC-E-FS-5CON-M16/0,5 SCO	1520039	37
SACB-8/16-L-SC SCO P	1453038	262	SACC-DSI-M12FS-12CON-M16/0,5	1419713	49	SACC-E-FS-8CON-M16/0,5 SCO	1523476	37
SACB-8/16-SC SCO P	1452974	262	SACC-DSI-M12FS-12P-M16XL0,5	1411589	50	SACC-E-FSB-5CON-M16/0,5 SCO	1520000	37
SACB-8/16-L-PUR SCO FLK14/MCV3P	1547928	265	SACC-DSI-M12FS-17CON-M16/0,5	1419739	49	SACC-E-FSD-4CON-M16/0,5 PP	1027686	36
SACB-8Q/4P- 5,0PUR	1683701	267	SACC-DSI-M12FS-17P-M16XL0,5	1411590	50	SACC-E-FSD-4CON-M16/0,5 SCO	1535202	37
SACB-8Q/4P- 10,0PUR	1683714	267	SACC-DSI-M12FS-4CON-M16/0,5	1419632	49	SACC-E-M 8FS-3CON-M8/0,5	1500350	33
SACB-8Q/4P-L- 5,0PUR	1695281	267	SACC-DSI-M12FS-4P-M16XL0,5	1411584	50	SACC-E-M 8FS-4CON-M8/0,5	1500363	33
SACB-8Q/4P-L- 10,0PUR	1695294	267	SACC-DSI-M12FS-5CON-M16/0,5	1419658	49	SACC-E-M 8FS-6CON-M 8/0,5	1542677	33
SACB-8Q/4P-L-SC	1662955	267	SACC-DSI-M12FS-5CON-PG9/0,5 P	1436356	52	SACC-E-M 8MS-3CON-M8/0,5	1500334	33
SACB-8Q/4P-L-SC NPN	1680872	267	SACC-DSI-M12FS-5P-M16XL0,5	1411586	50	SACC-E-M 8MS-4CON-M8/0,5	1500347	33
SACB-8Q/4P-SC	1683659	267	SACC-DSI-M12FS-8CON-M16/0,5	1419690	49	SACC-E-M 8MS-6CON-M 8/0,5	1542664	33
SACB-8X0-5/3X1,0-5,0 PUR SH	1401240	305	SACC-DSI-M12FS-8CON-PG9/0,5 P	1436369	52	SACC-E-M12FS-12P-M16XL0,5	1411574	39
SACB-8X0,5/3X1,0-50,0 HPUR	1401690	305	SACC-DSI-M12FS-8P-M16XL0,5	1411588	50	SACC-E-M12FS-17P-M16XL0,5	1411576	39
SACB-C-H180 8/16 SCO	1516713	265	SACC-DSI-M12FSB-5CON-M16/0,5	1419674	49	SACC-E-M12FS-4CON-M20/0,5	1408436	40
SACB-C-H180 8/4 QO-0,34	1560235	315	SACC-DSI-M12FSB-5P-M16XL0,5	1411587	50	SACC-E-M12FS-4CON-PG9/0,5	1693788	35
SACB-C-H180 8/3- 5,0PUR-M8	1516292	261	SACC-DSI-M12FSD-4CON-M16/0,5	1419616	49	SACC-E-M12FS-4CON-PG9/0,5 FFVA	1431429	424
SACB-C-H180- 4/3-10,0PUR-M8	1516302	261	SACC-DSI-M12FSD-4P-M16XL0,5	1411585	50	SACC-E-M12FS-4P-M16XL0,5	1411568	39
SACB-C-H180- 4/3-M8	1521229	261	SACC-DSI-M12FSK-4PE-M16XL0,2	1415294	284	SACC-E-M12FS-5CON-M20/0,5	1408454	40
SACB-C-H180- 6/3- 5,0PUR-M8	1516315	261	SACC-DSI-M12FSK4PE-M16/0,2-1,5	1425638	284	SACC-E-M12FS-5CON-PG9/0,5	1671098	35
SACB-C-H180- 6/3-10,0PUR-M8	1516328	261	SACC-DSI-M12FSL-4CON-M16XL0,2	1425589	285	SACC-E-M12FS-5P-M16XL0,5	1411571	39
SACB-C-H180- 6/3-M8	1521216	261	SACC-DSI-M12FSL-4FE-M16XL0,2	1415299	286	SACC-E-M12FS-8CON-M20/0,5	1408453	40
SACB-C-H180- 8/3- 5,0PUR-M8	1516331	261	SACC-DSI-M12FSL4CONM16/0,2-1,5	1425634	285	SACC-E-M12FS-8CON-PG9/0,5	1513758	35
SACB-C-H180- 8/3-10,0PUR-M8	1516344	261	SACC-DSI-M12FSL4FE-M16XL0,2GR	1425585	286	SACC-E-M12FS-8P-M16XL0,5	1411573	39
SACB-C-H180- 8/3-M8	1516425	261	SACC-DSI-M12FSL4FEM16/0,2GR-1,5	1425630	286	SACC-E-M12FSB-5P-M16XL0,5	1411572	39
SACB-C-H180-10/3- 5,0PUR-M8	1516357	261	SACC-DSI-M12FSM-5PE-M16XL0,2	1415303	287	SACC-E-M12FSD-4P-M16XL0,5	1411569	39
SACB-C-H180-10/3-10,0PUR-M8	1516360	261	SACC-DSI-M12FSS-3P-M16/0,5 PE	1411652	281	SACC-E-M12FSK-4PE-M16XL0,2	1415292	284
SACB-C-H180-10/3-M8	1516412	261	SACC-DSI-M12FSS-4CON-M16/0,5	1419700	49	SACC-E-M12FSK4PE-M16XL0,2-1,5	1425636	284
SACB-C-H180-4/ 4- 5,0PUR SCO	1516353	265	SACC-DSI-M12FSS-4P-M16XL0,5PE	1411598	283	SACC-E-M12FSL-4CON-M16XL0,2	1425587	285
SACB-C-H180-4/ 4- 5,0PUR SCO P	1453054	263	SACC-DSI-M12FST-4CON-M16/0,5	1424134	282	SACC-E-M12FSL-4FE-M16XL0,2	1415296	286
SACB-C-H180-4/ 4-10,0PUR SCO	1516548	265	SACC-DSI-M12FST-4P-M16XL0,5	1411599	283	SACC-E-M12FSL-4FE-M16XL0,2 GR	1425583	286
SACB-C-H180-8/ 8- 5,0PUR SCO	1516593	265	SACC-DSI-M12MS-12CON-M16/0,5	1419700	49	SACC-E-M12FSL4CONM16XL0,2-1,5	1425632	285
SACB-C-H180-8/ 8- 5,0PUR SCO P	1453083	263	SACC-DSI-M12MS-12P-M16XL0,5	1411596	50	SACC-E-M12FSL4FEM16XL0,2GR-1,5	1425628	286
SACB-C-H180-4/ 8-10,0PUR SCO	1516603	265	SACC-DSI-M12MS-17CON-M16/0,5	1419726	49	SACC-E-M12FSM-5PE-M16XL0,2	1415301	287
SACB-C-H180-4/ 8-10,0PUR SCO P	1453096	263	SACC-DSI-M12MS-17P-M16XL0,5	1411597	50	SACC-E-M12FSS-3P-M16/0,5 PE	1411654	281
SACB-C-H180-6/ 6- 5,0PUR SCO	1516551	265	SACC-DSI-M12MS-4CON-M16/0,5	1419629	49	SACC-E-M12FSS-4CON-M16/0,5 PE	1424137	282
SACB-C-H180-6/ 6- 5,0PUR SCO P	1453119	263	SACC-DSI-M12MS-4P-M16XL0,5	1411591	50	SACC-E-M12FSS-4P-M16XL0,5 PE	1411605	283
SACB-C-H180-6/ 6-10,0PUR SCO	1516564	265	SACC-DSI-M12MS-5CON-M16/0,5	1419645	49	SACC-E-M12FST-4CON-M16/0,5	1424138	282
SACB-C-H180-6/ 8- 5,0PUR SCO	1453122	263	SACC-DSI-M12MS-5P-M16XL0,5	1411593	50	SACC-E-M12FST-4P-M16XL0,5	1411606	283
SACB-C-H180-6/12- 5,0PUR SCO	1516616	265	SACC-DSI-M12MS-8CON-M16/0,5	1419687	49	SACC-E-M12MS-12P-M16XL0,5	1411582	39
SACB-C-H180-6/12- 5,0PUR SCO P	1453148	263	SACC-DSI-M12MS-8P-M16XL0,5	1411595	50	SACC-E-M12MS-17P-M16XL0,5	1411583	39
SACB-C-H180-8/12-10,0PUR SCO	1516629	265	SACC-DSI-M12MSB-5CON-M16/0,5	1419661	49	SACC-E-M12MS-4CON-M20/0,5	1408451	40
SACB-C-H180-8/ 8- 5,0PUR SCO	1516577	265	SACC-DSI-M12MSB-5P-M16XL0,5	1411594	50	SACC-E-M12MS-4CON-PG9/0,5	1693762	35
SACB-C-H180-8/ 8- 5,0PUR SCO P	1453177	263	SACC-DSI-M12MSD-4CON-M16/0,5	1419603	49	SACC-E-M12MS-4CON-PG9/0,5 FFVA	1431432	424
SACB-C-H180-8/ 8-10,0PUR SCO	1516580	265	SACC-DSI-M12MSD-4P-M16XL0,5	1411592	50	SACC-E-M12MS-4P-M16XL0,5	1411577	39
SACB-C-H180-8/ 8-10,0PUR SCO P	1453180	263	SACC-DSI-M12MSK-4PE-M16XL0,2	1415293	284	SACC-E-M12MS-5CON-M20/0,5	1408446	40
SACB-C-H180-8/16- 5,0PUR SCO	1516632	265	SACC-DSI-M12MSK4PE-M16/0,2-1,5	1425587	284	SACC-E-M12MS-5CON-PG9/0,5	1671111	35
SACB-C-H180-8/16- 5,0PUR SCO P	1453203	263	SACC-DSI-M12MSL-4CON-M16XL0,2	1425588	285	SACC-E-M12MS-5P-M16XL0,5	1411579	39
SACB-C-H180-8/16- 5,0PUR SCO P	1453203	263	SACC-DSI-M12MSL-4FE-M16XL0,2	1415297	286	SACC-E-M12MS-8CON-M20/0,5	1408442	40
SACB-C-H180-8/16-10,0PUR SCO	1516645	265	SACC-DSI-M12MSL4CONM16/0,2-1,5	1425633	285	SACC-E-M12MS-8CON-PG9/0,5	1513774	35
SACB-C-H180-8/16-10,0PUR SCO P	1453216	263	SACC-DSI-M12MSL4FE-M16XL0,2GR	1425584	286	SACC-E-M12MS-8P-M16XL0,5	1411581	39
SACB-C-D PG 13,5 (4,0-6,5) YE	1680377	316	SACC-DSI-M12MSL4FEM16/0,2GR-1,5	1425629	286	SACC-E-M12MSB-5P-M16XL0,5	1411580	39
SACB-D PG 13,5 (6,5-9,5) BK	1680390	316	SACC-DSI-M12MSM-5PE-M16XL0,2	1415302	287	SACC-E-M12MSD-4P-M16XL0,5	1411578	39
SACB-D PG 13,5 (9,0-13,0) RD	1680393	316	SACC-DSI-M12MSS-3P-M16/0,5 PE	1411653	281	SACC-E-M12MSK-4PE-M16XL0,2	1415291	284
SACC BIT M12-D20	1208445	306	SACC-DSI-M12MSS-4CON-M16/0,5PE	1424132	282	SACC-E-M12MSK4PE-M16XL0,2-1,5	1425635	284
SACC BIT M8-D12	1208474	306	SACC-DSI-M12MSS-4P-M16XL0,5PE	1411603	283	SACC-E-M12MSL-4CON-M16XL0,2	1425586	285
SACC-4P-DSI-M12FSD/FSD-M16	1424326	53	SACC-DSI-M12MST-4CON-M16/0,5	1424136	282	SACC-E-M12MSL-4FE-M16XL0,2	1415295	286
SACC-E-M12MSL-4FE-M16XL0,2 GR	1425582	286	SACC-E-M12MST-4M-M16XL0,5	1411608	39	SACC-E-M12MST-4M-M16XL0,5	1411608	39
SACC-E-M12MSL4CONM16XL0,2-1,5	151425627	285	SACC-E-M5FS-3CON-M5/0,5	1530595	32	SACC-E-M5FS-3CON-M5/0,5	1530595	32
SACC-E-M12MST-4CON-M16/0,5	1424140	282	SACC-E-M5FS-4CON-M5/0,5	1530618	32	SACC-E-M5FS-4CON-M5/0,5	1530618	32
SACC-E-M12MST-4M-M16XL0,5	1411608	283	SACC-E-M5MS-3CON-M5/0,5	1530582	32	SACC-E-M5MS-3CON-M5/0,5	1530582	32
SACC-E-M12MST-4M-M16XL0,5	1411608	283	SACC-E-M5MS-4CON-M5/0,5	1530592	32	SACC-E-M5MS-4CON-M5/0,5	1530592	32
SACC-E-M12MSS-3P-M16/0,5 PE	1411655	281	SACC-E-M8MS-5CON-M10/0,5 DN	1424233	33	SACC-E-M8MS-5CON-M10/0,5 DN	1424233	33
SACC-E-M12MSS-4CON-M16/0,5 PE	1424139	282	SACC-E-M8MS-8CON-M10/0,5	1424231	33	SACC-E-M8		

Index

Alphabetical

Type	Order No.	Page	Type	Order No.	Page	Type	Order No.	Page	Type	Order No.	Page
SACC-M 8MR-4CON-M	1554209	18	SACC-M12FS-5CON-PG 9 SH AU	1508365	24	SACC-M12MS-4CON-PG 7-M SKIN	1556870	23	SACC-MS-400 SH PBPA SCO	1413933	423
SACC-M 8MR-4CON-M-SW	1407585	17	SACC-M12FS-5CON-PG 9-SH	1694318	24	SACC-M12MS-4CON-PG 7-SH	1693830	24	SACC-MS-400-0,75 SH SCO	1413993	423
SACC-M 8MR-4CON-SH	1436466	18	SACC-M12FS-5CON-PG 9-VA	1553271	23	SACC-M12MS-4CON-PG 7-VA	1553161	23	SACC-MS-500 SH DN SCO	1422759	21
SACC-M 8MS-3CON-M	1681156	18	SACC-M12FS-5CON-PG11-DUO	1694596	25	SACC-M12MS-4CON-PG 9-SH	1501540	24	SACC-MS-500-0,75 SH SCO	1413991	21
SACC-M 8MS-3CON-M-0,34-SH	1542884	17	SACC-M12FS-5CON-PG11-DUO VA	1403372	25	SACC-M12MS-4CON-PG 9-VA	1553174	23	SACC-MS-800 SH ETH SCO	1421679	343
SACC-M 8MS-3CON-M-SH	1506901	18	SACC-M12FS-5CON-PG11-M PWR	1404418	22	SACC-M12MS-4CON-PG11-DUO-M	1507052	25	SACC-MS-800-0,5 SH SCO	1414610	423
SACC-M 8MS-3CON-M-SW	1501252	17	SACC-M12FS-5CON-PG 7-M SKIN	1559000	23	SACC-M12MS-4CON-PG11-M PWR	1404415	22	SACC-MSB-200 SH PB SCO	1413931	21
SACC-M 8MS-300-0,25-M	1441008	16	SACC-M12FS-5CON-PG9	1500787	22	SACC-M12MS-4CON-PG9-M	1523230	22	SACC-MSD-400 SH ETH SCO	1411066	343
SACC-M 8MS-300-0,5-M	1441024	16	SACC-M12FS-5CON-PG9-M	1681486	22	SACC-M12MS-4PL	1424691	19	SACC-MSD-400 SH PN SCO	1411068	343
SACC-M 8MS-4CON-M	1681169	18	SACC-M12FS-5CON-PG9-M SKIN	1556838	23	SACC-M12MS-4PL M	1424657	19	SACC-P12MSX-25-3,2 SCO	1419959	44
SACC-M 8MS-4CON-M-0,34-SH	1542897	17	SACC-M12FS-5CT-CM SH	1422852	27	SACC-M12MS-4PL SH	1424666	19	SACC-MSQ-P-M12MS-25-2,7 SCO	1424131	280
SACC-M 8MS-4CON-M-SH	1506914	18	SACC-M12FS-5PL	1424689	19	SACC-M12MS-4PL SH CCL	1424699	423	SACC-MSX-800 SH ETH SCO	1411043	342
SACC-M 8MS-4CON-M-SW	1501265	17	SACC-M12FS-5PL M	1424652	19	SACC-M12MS-400-0,34	1641714	20	SACC-P12MR-5CT-CM SH	1021816	27
SACC-M 8MS-400-0,25-M	1440111	16	SACC-M12FS-5PL SH	1424660	19	SACC-M12MS-400-0,34-M	1641691	20	SACC-P12MRD-4CT-CM SH PN	1021831	27
SACC-M 8MS-400-0,5-M	1441037	16	SACC-M12FS-5PL SH DN	1424672	423	SACC-M12MS-400-0,34-VA	1440753	20	SACC-P12MRX-9CT-CL SH	1021784	27
SACC-M12-KD-NUT-SH	1440151	56	SACC-M12FS-6Q SH VARAN	1429143	343	SACC-M12MS-400-0,75	1641769	20	SACC-P12MS-5CT-CM SH	1021815	27
SACC-M12-SET/2,5-3,5	1436505	22	SACC-M12FS-8CON-PG 9-SH	1511860	24	SACC-M12MS-400-0,75-M	1641785	20	SACC-P12MSD-4CT-CM SH PN	1021830	27
SACC-M12FR-12SOL-PG 9-M	1404223	26	SACC-M12FS-8CON-PG11-M	1424664	22	SACC-M12MS-400-0,75-VA	1440779	20	SACC-P12MSX-8CT-CL SH	1021783	27
SACC-M12FR-12SOL-PG 9-M SH	1404413	26	SACC-M12FS-8CON-PG9-M	1513347	22	SACC-M12MS-5CON-DM 3-5 SH VA	1440012	24	SACC-PG9-KD-NUT-SH	1440177	56
SACC-M12FR-4CON-PG 7-VA	1553284	23	SACC-M12FSB-2PL SH PB	1424680	422	SACC-M12MS-5CON-DM 5-8 SH VA	1440025	24	SACC-PG9-SEAL CLM	1556320	56
SACC-M12FR-4CON-PG11-M PWR	1408991	22	SACC-M12FSB-5CON-PG9 SH AU	1507777	422	SACC-M12MS-5CON-PG 7	1662256	22	SACC-SQ-M12FS-12CON-20/0,5	1441710	42
SACC-M12FR-4CON-PG7	1681130	22	SACC-M12FSB-5PL SH	1424664	19	SACC-M12MS-5CON-PG 7-M	1663116	22	SACC-SQ-M12FS-12CON-25F/0,5	1441590	43
SACC-M12FR-4CON-PG7-M	1681143	22	SACC-M12FSB-5PL SH IB	1424676	422	SACC-M12MS-5CON-PG 7-SH	1693416	24	SACC-SQ-M12FS-17CON-20/0,5	1441736	42
SACC-M12FR-4PL	1424694	19	SACC-M12FSD-4CT-CM SH PN	1422848	27	SACC-M12MS-5CON-PG 7-VA	1553187	23	SACC-SQ-M12FS-17CON-25F/0,5	1441613	43
SACC-M12FR-4PL M	1424656	19	SACC-M12FSD-4PL SH PN	1424683	343	SACC-M12MS-5CON-PG 9	1500774	22	SACC-SQ-M12FS-4CON-20/0,5	1419797	42
SACC-M12FR-4PL SH	1424669	19	SACC-M12FSK-4PECON-PG13-M	1424708	279	SACC-M12MS-5CON-PG 9 SH AU	1508352	24	SACC-SQ-M12FS-4CON-25F/0,5	1420003	43
SACC-M12FR-5CON-PG 7	1662308	22	SACC-M12FSK-4PECT-CL SH	1027476	279	SACC-M12MS-5CON-PG 9-M	1681460	22	SACC-SQ-M12FS-5CON-20/0,5	1441655	42
SACC-M12FR-5CON-PG 7-M	1662984	22	SACC-M12FSL-4CT-CL SH	1027480	278	SACC-M12MS-5CON-PG 9-SH	1694266	24	SACC-SQ-M12FS-5CON-25F/0,5	1440986	43
SACC-M12FR-5CON-PG 7-VA	1553297	23	SACC-M12FSL-4FECT-CL SH	1027478	278	SACC-M12MS-5CON-PG 9-VA	1553190	23	SACC-SQ-M12FS-8CON-20/0,5	1441697	42
SACC-M12FR-5CON-PG 9-SH	1430433	24	SACC-M12FSL-5CON-PG13-M	1424710	278	SACC-M12MS-5CON-PG11-DUO	1662285	25	SACC-SQ-M12FS-8CON-25F/0,5	1441574	43
SACC-M12FR-5CON-PG 9-VA	1553307	23	SACC-M12FSS-2PECON-PG 9-M	1419640	279	SACC-M12MS-5CON-PG11-DUO VA	1403371	25	SACC-SQ-M12FSB-5CON-20/0,5	1441671	42
SACC-M12FR-5CON-PG11-M PWR	1408993	22	SACC-M12FSS-3PECON-PG11-M	1404642	279	SACC-M12MS-5CON-PG11-DUO VA	1662748	25	SACC-SQ-M12FSB-5CON-25F/0,5	1441558	43
SACC-M12FR-5CON-PG9	1500790	22	SACC-M12FSS-3PECT-CL SH	1027469	279	SACC-M12MS-5CON-PG11-M PWR	1404417	22	SACC-SQ-M12FSD-4CON-20/0,5	1441639	42
SACC-M12FR-5CON-PG9-M	1681499	22	SACC-M12FST-3PECON-PG11-M	1404644	278	SACC-M12MS-5CON-PG7-M SKIN	1456466	23	SACC-SQ-M12FSD-4CON-25F/0,5	1440960	42
SACC-M12FR-5CON-PG9-M SKIN	1556812	23	SACC-M12FST-4CT-CL SH	1027466	278	SACC-M12MS-5CON-PG9-M SKIN	1556825	23	SACC-SQ-M12MS-12CON-20/0,5	1441707	42
SACC-M12FR-5CT-CM SH	1422853	27	SACC-M12MR-12SOL-PG 9-M	1404421	26	SACC-M12MS-5CT-CM SH	1422850	27	SACC-SQ-M12MS-12CON-25F/0,5	1441587	43
SACC-M12FR-5PL	1424690	19	SACC-M12MR-12SOL-PG 9-M SH	1404412	26	SACC-M12MS-5PL	1424686	19	SACC-SQ-M12MS-17CON-20/0,5	1441723	42
SACC-M12FR-5PL M	1424653	19	SACC-M12MR-4CON-PG 7-SH	1694279	24	SACC-M12MS-5PL M	1424649	19	SACC-SQ-M12MS-17CON-25F/0,5	1441600	43
SACC-M12FR-5PL SH	1424661	19	SACC-M12MR-4CON-PG 7-VA	1553200	23	SACC-M12MS-5PL SH	1424658	19	SACC-SQ-M12MS-4CON-20/0,5	1419784	42
SACC-M12FR-5PL SH DN	1424673	423	SACC-M12MR-4CON-PG 9-VA	1553226	23	SACC-M12MS-5PL SH DN	1424670	423	SACC-SQ-M12MS-4CON-25F/0,5	1419991	43
SACC-M12FR-6Q SH VARAN	1429169	343	SACC-M12MR-4CON-PG11-M PWR	1408990	22	SACC-M12MS-6Q SH VARAN	1429130	343	SACC-SQ-M12MS-5CON-20/0,5	1441642	42
SACC-M12FR-8Q SH	1553666	343	SACC-M12MR-4CON-PG7	1681091	22	SACC-M12MS-8CON-PG 9-SH	1511857	24	SACC-SQ-M12MS-5CON-25F/0,5	1440973	43
SACC-M12FRB-2PL SH PB	1424681	422	SACC-M12MR-4CON-PG7-M	1681101	22	SACC-M12MS-8CON-PG11-M	1410666	22	SACC-SQ-M12MS-8CON-20/0,5	1441684	42
SACC-M12FRB-5CON-PG 9-SH	1430420	422	SACC-M12MR-4PL	1424692	19	SACC-M12MS-8CON-PG9-M	1513334	22	SACC-SQ-M12MS-8CON-25F/0,5	1441561	43
SACC-M12FRB-5PL SH	1424665	19	SACC-M12MR-4PL M	1424654	19	SACC-M12MSB-2PL SH PB	1424678	422	SACC-SQ-M12MSB-5CON-20/0,5	1441668	42
SACC-M12FRB-5PL SH IB	1424677	422	SACC-M12MR-4PL SH	1424667	19	SACC-M12MSB-5CON-PG9 SH AU	1507764	422	SACC-SQ-M12MSB-5CON-25F/0,5	1440999	43
SACC-M12FRD-4CT-CM SH PN	1422849	27	SACC-M12MR-5CON-PG 7	1662269	22	SACC-M12MSB-5PL SH	1424662	19	SACC-SQ-M12MSD-4CON-20/0,5	1441626	42
SACC-M12FRD-4PL SH PN	1424685	343	SACC-M12MR-5CON-PG 7-M	1663129	22	SACC-M12MSB-5PL SH IB	1424674	422	SACC-SQ-M12MSD-4CON-25F/0,5	1440957	43
SACC-M12FRD-4Q SH	1553637	343	SACC-M12MR-5CON-PG 7-SH	1693429	24	SACC-M12MSD-4CT-CM SH PN	1422846	27	SACC-V-3CON-M16/A-1L-S	1544714	29
SACC-M12FRD-4Q SH PN	1554542	343	SACC-M12MR-5CON-PG 7-VA	1553213	23	SACC-M12MSD-4PL SH PN	1424682	343	SACC-V-3CON-PG9/A-1L-S	1671137	29
SACC-M12FRS-2PECON-PG 9-M	1419642	279	SACC-M12MR-5CON-PG 9-SH	1694282	24	SACC-M12MSK-8CON-PG13-M	1424707	279	SACC-V-3CON-PG9/B-1L-S	1671153	30
SACC-M12FRS-3PECON-PG11-M	1408987	279	SACC-M12MR-5CON-PG 9-VA	1553239	23	SACC-M12MSK-4PECT-CL SH	1027474	279	SACC-V-3CON-PG9/BH-1L-S	1671140	30
SACC-M12FRT-4CON-PG11-M	1408989	278	SACC-M12MR-5CON-PG11-DUO	1531044	25	SACC-M12MSL-4CT-CL SH	1027479	278	SACC-VB-3CON-M12/C-1L-SV 24V	1452262	31
SACC-M12FS-12SOL-PG 9-M	1404420	26	SACC-M12MR-5CON-PG11-M PWR	1408992	22	SACC-M12MSL-4FECT-CL SH	1027477	278	SACC-VB-3CON-M12/C-1L-SV 110V	1452275	31
SACC-M12FS-4CON-PG 9-M SH	1404411	26	SACC-M12MR-5CON-PG9	1513431	22	SACC-M12MSL-5CON-PG13-M	1424709	278	SACC-VB-3CON-M12/C-1L-SV 230V	1452288	31
SACC-M12FS-4CON-PG 7-SH	1694295	24	SACC-M12MR-5CON-PG9-M	1681473	22	SACC-M12MSS-2PECON-PG 9-M	1419639	279	SACC-VB-3CON-M12/C1-1L-SV 24V	1452291	31
SACC-M12FS-4CON-PG 7-VA	1553242	23	SACC-M12MR-5CON-PG9-M SKINTOP	1561742	23	SACC-M12MSS-3PECON-PG11-M	1404641	279	SACC-VB-3CON-M12/C1-1L-SV 110V	1452301	31
SACC-M12FS-4CON-PG 9-M	1696439	24	SACC-M12MR-5CT-CM SH	1422851	27	SACC-M12MSS-3PECT-CL SH	1027467	279	SACC-VB-3CON-M12/C1-1L-SV 230V	1452314	31
SACC-M12FS-4CON-PG 9-SH	1515170	24	SACC-M12MR-5PL	1424688	19	SACC-M12MST-3PECON-PG11-M	1404643	278	SACC-VB-3CON-M16/A-1L-SV	1452123	28
SACC-M12FS-4CON-PG 9-VA	1553268	23	SACC-M12MR-5PL M	1424651	19	SACC-M12MST-4CT-CL SH	1027465	278	SACC-VB-3CON-M16/A-1L-SV 110V	1452152	28
SACC-M12FS-4CON-PG11-M PWR	1404416	22	SACC-M12MR-5PL SH	1424659	19	SACC-M12MSX-8CT-CL SH	1422844	27	SACC-VB-3CON-M16/A-1L-SV 230V	1452165	28
SACC-M12FS-4CON-PG7	1681114	22	SACC-M12MR-5PL SH DN	1424671	423	SACC-M16-KD-NUT-SH	1440164	56	SACC-VB-3CON-M16/A-1L-SV 24V	1452149	28
SACC-M12FS-4CON-PG7-M	1681127	22	SACC-M12MR-6Q SH VARAN	1429156	343	SACC-M16-SEAL CLM	1430394	56	SACC-VB-3CON-M16/A-GVL 110V	1452181	29
SACC-M12FS-4CON-PG7-M SKIN	1430381	23	SACC-M12MR-8Q SH	1553653	343	SACC-M16-SEALING PLUG SET	1453368	54	SACC-VB-3CON-M16/A-GVL 12/24V	1452178	29
SACC-M12FS-4PL	1424693	19	SACC-M12MRB-2PL SH PB	1424679	422	SACC-M16FR-14CON-M	1500253	311	SACC-VB-3CON-M16/A-GVL 230V	1452194	29
SACC-M12FS-4PL M	1424655	19	SACC-M12MRB-5CON-PG 9-SH	1430417	422	SACC-M16FR-14CON-M	1500554	311	SACC-VB-3CON-M16/B-1L-SV 110V	1452217	30
SACC-M12FS-4PL SH	1424668	19	SACC-M12MRB-5PL SH	1424663	19	SACC-MCH-M12MS-4CON	1440931	45	SACC-VB-3CON-M16/B-1L-SV 230V	1452220	30
SACC-M12FS-4PL SH CCL	1424700	423	SACC-M12MRB-5PL SH IB	1424675	422	SACC-MCH-M12MS-4CON/0,5	1440805	44	SACC-VB-3CON-M16/B-1L-SV 24V	1452204	30
SACC-M12FS-400-0,34	1641701	20	SACC-M12MRD-4CT-CM SH PN	1422847	27	SACC-MCH-M12MS-5CON	1419988	45	SACC-VB-3CON-M16/BI-1L-SV 24V	1452233	30
SACC-M12FS-400-0,34-M	1641688	20	SACC-M12MRD-4PL SH PN	1424684	343	SACC-MCH-M12MS-5CON/0,5	1440818	44	SACC-VB-3CON-M16/BI-1L-SV 110V	1452246	30
SACC-M12FS-400-0,34-VA	1440766	20	SACC-M12MRD-4Q SH	1553624	343	SACC-MCH-M12MS-8CON	1440928	45	SACC-VB-3CON-M16/BI-1L-SV 230V	1452259	30
SACC-M12FS-400-0,75	1641756	20	SACC-M12MRD-4Q SH PN	1554539	343	SACC-MCH-M12MS-8CON/0,5	1457827	44			

Type	Order No.	Page	Type	Order No.	Page	Type	Order No.	Page	Type	Order No.	Page
SACCBP-FS-5CON-M16/2,0-PUR SCO	1419331	51	SACCEC-M12MSB-2CON-M16/0,5-910	1525555	426	SB-8ESSD8A8L32S	1623686	126	SF-5ES1N8A8LB2S	1618199	154
SACCBP-FS-5CON-PG9/0,5-920SCO	1437520	427	SACCEC-M12MSB-2CON-M16/1,0-910	1525568	426	SB-8ESSD8A8L33S	1623687	126	SF-5ES1N8A8LB3	1605546	154
SACCBP-FS-5CONSCO	1437533	427	SACCEC-M12MSB-2CON-M16/2,0-910	1519561	426	SB-8ESSD8A8L34S	1623688	126	SF-5ES1N8A8LB3S	1618200	154
SACCBP-FS-5CON-PG9/2,0-920SCO	1437546	427	SACCEC-M12MSB-2CON-M16/5,0-910	1525571	426	SB-8ESSD8A9L32S	1623704	127	SF-5ES1N8A8LB4	1605548	154
SACCBP-FS-5CON-PG9/5,0-920SCO	1437559	427	SACCEC-M12MSB-5CON-M16/0,5-900	1529629	425	SB-8ESSD8A9L33S	1623705	127	SF-5ES1N8A8LB4S	1618201	154
SACCBP-FS-8CON-M16/1,0-PUR SCO	1419357	51	SACCEC-M12MSB-5CON-M16/1,0-900	1530223	425	SB-8ESSD8A9L34S	1623706	127	SF-5ES1N8A8LDL	1605549	154
SACCBP-FS-8CON-M16/2,0-PUR SCO	1419344	51	SACCEC-M12MSB-5CON-M16/2,0-900	1529726	425	SB-8ESSD8AA700S	1623720	128	SF-5ES1N8A8LDLS	1618202	154
SACCBP-FSB-2CON-PG9/0,5-910SCO	1437449	426	SACCEC-M12MSB-5CON-M16/5,0-900	1529739	425	SB-8ESSD8AWT00S	1623726	128	SF-5ES1N8AY000	1607082	157
SACCBP-FSB-2CON-PG9/1,0-910SCO	1437452	426	SB-10KP001	1623607	129	SB-Z0001	1623827	182	SF-5ES1N8AYW00	1607405	157
SACCBP-FSB-2CON-PG9/2,0-910SCO	1437465	426	SB-10KP002	1623611	129	SB-Z0002	1623828	182	SF-6AP2000	1605554	113
SACCBP-FSB-2CON-PG9/5,0-910SCO	1437478	426	SB-10KP003	1623612	129	SB-Z0016	1624515	177	SF-6AS2000	1605557	113
SACCBP-FSB-5CON-PG9/0,5-900SCO	1437601	425	SB-10KP004	1623613	129	SB-Z0026	1624618	177	SF-6CP2000	1605559	113
SACCBP-FSB-5CON-PG9/1,0-900SCO	1437614	425	SB-10KS001	1623603	129	SC-Z2319	1605456	182	SF-6CS2000	1605562	113
SACCBP-FSB-5CON-PG9/2,0-900SCO	1437627	425	SB-10KS002	1623604	129	SC-Z2320	1605457	182	SF-7EP1N8AS000	1605567	159
SACCBP-FSB-5CON-PG9/5,0-900SCO	1437630	425	SB-10KS003	1623605	129	SEALING PLUG 10X16 RD	1400284	480	SF-7EP1N8A90A1	1605568	155
SACCBP-FSD-4CON-PG9/1,0-933SCO	1437779	397	SB-10KS004	1623606	129	SEALING PLUG 12X22 RD	1400260	707	SF-7EP1N8A90A2	1605570	155
SACCBP-FSD-4CON-PG9/2,0-933SCO	1437782	397	SB-36KP002	1623383	129	SEALING PLUG 13X22 RD	1400265	707	SF-7EP1N8A90A3	1605571	155
SACCBP-FSD-4CON-PG9/5,0-933SCO	1437795	397	SB-36KP003	1623384	129	SEALING PLUG 14X22 RD	1400270	480	SF-7EP1N8A90DU	1605575	155
SACCBP-M12FS-5CON-M16/0,5-920	1534465	427	SB-36KP004	1623385	129	SEALING PLUG 17X17 RD	1421861	707	SF-7EP1N8A9LB1	1605578	155
SACCBP-M12FS-5CON-M16/1,0-920	1534478	427	SB-36KP005	1623386	129	SEALING PLUG 20X22 RD	1421862	707	SF-7EP1N8A9LB2	1605580	155
SACCBP-M12FS-5CON-M16/2,0-920	1534481	427	SB-36KS002	1623378	129	SEALING PLUG 25X30 RD	1421863	707	SF-7EP1N8A9LB3	1605581	155
SACCBP-M12FS-5CON-M16/5,0-920	1534494	427	SB-36KS003	1623379	129	SEALING PLUG 28X30 RD	1421864	707	SF-7EP1N8A9LB4	1605582	155
SACCBP-M12FSB-2CON-M16/0,5-910	1534384	426	SB-36KS004	1623380	129	SEALING PLUG 35X35 RD	1421865	707	SF-7EP1N8A9LDL	1605583	155
SACCBP-M12FSB-2CON-M16/1,0-910	1534397	426	SB-36KS005	1623381	129	SEALING PLUG 3X12 RD	1400238	707	SF-7EP1N8AA500	1602660	156
SACCBP-M12FSB-2CON-M16/2,0-910	1534407	426	SB-8EPC8A8L32S	1623332	126	SEALING PLUG 48X35 RD	1425357	707	SF-7EP1N8AA600	1620662	156
SACCBP-M12FSB-5CON-M16/0,5-900	1534410	426	SB-8EPC8A8L33S	1623333	126	SEALING PLUG 5X12 RD	1400253	707	SF-7EP1N8AC0A1	1607048	158
SACCBP-M12FSB-5CON-M16/0,5-900	1534546	425	SB-8EPC8A8L34S	1623334	126	SEALING PLUG 6X16 RD	1400254	707	SF-7EP1N8AC0A2	1607049	158
SACCBP-M12FSB-5CON-M16/1,0-920	1534559	425	SB-8EPC8A8L32S	1623356	127	SEALING PLUG 7X16 RD	1400255	480	SF-7EP1N8AC0A3	1607050	158
SACCBP-M12FSB-5CON-M16/2,0-900	1534562	425	SB-8EPC8A8L33S	1623357	127	SEALING PLUG 8X16 RD	1400257	707	SF-7EP1N8AC0DU	1607051	158
SACCBP-M12FSB-5CON-M16/5,0-900	1534575	425	SB-8EPC8A8L34S	1623358	127	SEALING PLUG 9X16 RD	1400259	707	SF-7EP1N8ACLB1	1607052	158
SACCBP-M12MS-5CON-M16/0,5-920	1534423	427	SB-8EPC8AA700S	1623368	128	SF-08KP010	1621574	121	SF-7EP1N8ACLB2	1607053	158
SACCBP-M12MS-5CON-M16/1,0-920	1534436	427	SB-8EPC8AAWT00S	1623374	128	SF-08KP020	1621575	121	SF-7EP1N8ACLB3	1607054	158
SACCBP-M12MS-5CON-M16/2,0-920	1534449	427	SB-8EPCD8A8L32S	1623692	126	SF-08KS010	1621571	121	SF-7EP1N8ACLB4	1607055	158
SACCBP-M12MS-5CON-M16/5,0-920	1534452	427	SB-8EPCD8A8L33S	1623693	126	SF-08KS020	1621573	121	SF-7EP1N8ACLDL	1607056	158
SACCBP-M12MSB-2CON-M16/0,5-910	1534342	426	SB-8EPCD8A8L34S	1623694	126	SF-10KP004	1607355	113	SF-7EP1N8AWA00	1605589	156
SACCBP-M12MSB-2CON-M16/1,0-910	1534355	426	SB-8EPCD8A9L32S	1623710	127	SF-10KS004	1607356	113	SF-7EP1N8AWA00	1620620	156
SACCBP-M12MSB-2CON-M16/2,0-910	1534368	426	SB-8EPCD8A9L33S	1623711	127	SF-20KP004	1607376	160	SF-7ES1N8A80A1	1605595	154
SACCBP-M12MSB-2CON-M16/5,0-910	1534371	426	SB-8EPCD8A9L34S	1623712	127	SF-20KP011	1050147	148	SF-7ES1N8A80A1S	1618204	154
SACCBP-M12MSB-5CON-M16/0,5-900	1534504	425	SB-8EPCD8AA700S	1623722	128	SF-20KP012	1050205	148	SF-7ES1N8A80A2	1605596	154
SACCBP-M12MSB-5CON-M16/1,0-900	1534517	425	SB-8EPCD8AWT00S	1623728	128	SF-20KP013	1050210	148	SF-7ES1N8A80A2S	1618205	154
SACCBP-M12MSB-5CON-M16/2,0-900	1534520	425	SB-8EPSA8A8L32S	1623335	126	SF-20KP021	1621579	121	SF-7ES1N8A80A3	1605597	154
SACCBP-M12MSB-5CON-M16/5,0-900	1534533	425	SB-8EPSA8A8L33S	1623336	126	SF-20KP022	1621580	121	SF-7ES1N8A80A3S	1618206	154
SACCBP-MS-12CON-M16/1,0-PVCSCO	1442227	51	SB-8EPSA8A8L34S	1623337	126	SF-20KP023	1621581	121	SF-7ES1N8A80A4	1605602	154
SACCBP-MS-12CON-M16/2,0-PVCSCO	1442230	51	SB-8EPSA8A8L32S	1623359	127	SF-20KS021	1621576	121	SF-7ES1N8A80DUS	1618207	154
SACCBP-MS-17CON-M16/1,0-PVCSCO	1442308	51	SB-8EPSA8A9L33S	1623360	127	SF-20KS022	1621577	121	SF-7ES1N8A8LB1	1605605	154
SACCBP-MS-17CON-M16/2,0-PVCSCO	1442311	51	SB-8EPSA8A9L34S	1623361	127	SF-20KS023	1621578	121	SF-7ES1N8A8LB1S	1618208	154
SACCBP-MS-4CON-M16/1,0-PUR SCO	1419399	51	SB-8EPSA8AA700S	1623369	128	SF-5EE1N8AS000	1605492	159	SF-7ES1N8A8LB2	1605607	154
SACCBP-MS-4CON-M16/2,0-PUR SCO	1419386	51	SB-8EPSA8AAWT00S	1623375	128	SF-5EP1N8A90A1	1605494	155	SF-7ES1N8A8LB2S	1618209	154
SACCBP-MS-5CON-M16/1,0-PUR SCO	1419409	51	SB-8EPSD8A8L32S	1623695	126	SF-5EP1N8A90A2	1605496	155	SF-7ES1N8A8LB3	1605610	154
SACCBP-MS-5CON-M16/2,0-PUR SCO	1419412	51	SB-8EPSD8A8L33S	1623696	126	SF-5EP1N8A90A3	1605498	155	SF-7ES1N8A8LB3S	1618210	154
SACCBP-MS-5CON-PG9/0,5-920SCO	1437562	427	SB-8EPSD8A8L34S	1623697	126	SF-5EP1N8A90DU	1605499	155	SF-7ES1N8A8LB4	1605614	154
SACCBP-MS-5CON-PG9/1,0-920SCO	1437575	427	SB-8EPSD8A9L32S	1623713	127	SF-5EP1N8A9LB1	1605505	155	SF-7ES1N8A8LB4S	1618211	154
SACCBP-MS-5CON-PG9/2,0-920SCO	1437588	427	SB-8EPSD8A9L33S	1623714	127	SF-5EP1N8A9LB2	1605507	155	SF-7ES1N8A8LDL	1605617	154
SACCBP-MS-5CON-PG9/5,0-920SCO	1437591	427	SB-8EPSD8A9L34S	1623715	127	SF-5EP1N8A9LB3	1605508	155	SF-7ES1N8A8LDLS	1618212	154
SACCBP-MS-8CON-M16/1,0-PUR SCO	1419425	51	SB-8EPSD8AA700S	1623723	128	SF-5EP1N8A9LB4	1605509	155	SF-7ES1N8AY000	1605622	157
SACCBP-MS-8CON-M16/2,0-PUR SCO	1419438	51	SB-8EPSD8AWT00S	1623729	128	SF-5EP1N8A9LDL	1605510	155	SF-7ES1N8AYW00	1607429	157
SACCBP-MSB-2CON-PG9/0,5-910SCO	1437481	426	SB-8ESCA8A8L32S	1623324	126	SF-5EP1N8AA500	1620657	156	SF-7MP2000	1605626	160
SACCBP-MSB-2CON-PG9/1,0-910SCO	1437494	426	SB-8ESCA8A8L33S	1623327	126	SF-5EP1N8AA600	1620661	156	SF-7MS2000	1605628	160
SACCBP-MSB-2CON-PG9/2,0-910SCO	1437504	426	SB-8ESCA8A8L34S	1623328	126	SF-5EP1N8AC0A1	1605516	158	SF-7MS2000	1605631	160
SACCBP-MSB-2CON-PG9/5,0-910SCO	1437517	426	SB-8ESCA8A9L32S	1623339	127	SF-5EP1N8AC0A2	1607037	158	SF-7PP2000	1605634	160
SACCBP-MSB-5CON-PG9/0,5-900SCO	1437643	425	SB-8ESCA8A9L33S	1623341	127	SF-5EP1N8AC0A3	1607038	158	SF-7PS2000	1605636	160
SACCBP-MSB-5CON-PG9/1,0-900SCO	1437656	425	SB-8ESCA8A9L34S	1623342	127	SF-5EP1N8AC0DU	1605517	158	SF-7QP2000	1605639	160
SACCBP-MSB-5CON-PG9/2,0-900SCO	1437669	425	SB-8ESCA8AA700S	1623365	128	SF-5EP1N8ACLB1	1607039	158	SF-7QS2000	1605643	160
SACCBP-MSB-5CON-PG9/5,0-900SCO	1437672	425	SB-8ESCA8AAWT00S	1623371	128	SF-5EP1N8ACLB2	1607040	158	SF-7RP2000	1605646	160
SACCEC-M12FS-5CON-M16/0,5-920	1525678	427	SB-8ESCD8A8L32S	1623683	126	SF-5EP1N8ACLB3	1607041	158	SF-BIT-BHX 3-50	1121247	685
SACCEC-M12FS-5CON-M16/1,0-920	1525681	427	SB-8ESCD8A8L33S	1623684	126	SF-5EP1N8ACLB4	1607042	158	SF-M BH	1121070	685
SACCEC-M12FS-5CON-M16/2,0-920	1525694	427	SB-8ESCD8A8L34S	1623685	126	SF-5EP1N8ACLDL	1605518	158	SF-Z0019	1607449	181
SACCEC-M12FS-5CON-M16/5,0-920	1525704	427	SB-8ESCD8A9L32S	1623701	127	SF-5EP1N8AWA00	1605520	156	SF-Z0025	1607452	177
SACCEC-M12FSB-2CON-M16/0,5-910	1525597	426	SB-8ESCD8A9L33S	1623702	127	SF-5EP1S8AWA00	1620619	156	SF-Z0026	1607454	177
SACCEC-M12FSB-2CON-M16/1,0-910	1525607	426	SB-8ESCD8A9L34S	1623703	127	SF-5ES1N8A80A1	1605524	154	SF-Z0027	1607455	176
SACCEC-M12FSB-2CON-M16/2,0-910	1519574	426	SB-8ESCD8AA700S	1623719	128	SF-5ES1N8A80A1S	1618194	154	SF-Z0028	160	

Index

Alphabetical

Type	Order No.	Page	Type	Order No.	Page	Type	Order No.	Page	Type	Order No.	Page
SH-8EPC58A8LB3	1622009	118	SI-FP-R1A-D1A	1404496	709	SM-7ES1N8A8L32S	1613434	166	ST-10KP010	1618255	70
SH-8EPC58A8LB3S	1621531	118	SI-FP-R1A-D1B-U1A/0,7	1404504	710	SM-7ES1N8A8L33S	1613435	166	ST-10KP020	1618256	70
SH-8EPC58A8LB4	1622008	118	SI-FP-R1A-D1E	1404500	709	SM-7ES1N8A8L34S	1613436	166	ST-10KP035	1618458	70
SH-8EPC58A8LB4S	1621530	118	SI-FP-R1A-U1A	1404499	711	SM-7ES1N8A8S22	1613528	166	ST-10KS010	1618239	70
SH-8EPC58A8LDL	1622007	118	SI-FP-R1A-U1A-D1A	1404497	710	SM-7ES1N8A8S23	1613529	166	ST-10KS020	1618251	70
SH-8EPC58A8LDLS	1621529	118	SI-FP-R1A-U1A/0,7	1404512	710	SM-7ES1N8A8S24	1613530	166	ST-10KS035	1618464	70
SH-8EPC58A9LB1S	1621553	119	SI-M1A	1404493	708	SM-7ES1N8AY000	1605865	167	ST-17P1N8A6100S	1613540	69
SH-8EPC58A9LB2S	1621552	119	SI-M1B	1404494	708	SM-7ES1N8AY000S	1613534	167	ST-17P1N8A8003	1607624	66
SH-8EPC58A9LB3S	1621551	119	SI-RND-R1A	1425186	720	SM-7ES1N8AYW00	1607543	167	ST-17P1N8A8003S	1607625	66
SH-8EPC58A9LB4S	1621550	119	SI-RND-U1A	1425185	720	SM-7ES1N8AYW00S	1613535	167	ST-17P1N8A8004	1607626	66
SH-8EPC58A9LDLS	1621549	119	SL-16KP010	1607909	175	SM-Z0001	1605866	181	ST-17P1N8A8004S	1607627	66
SH-8EPC58AAC00S	1621561	120	SL-16KS010	1607956	175	SM-Z0003	1607935	179	ST-17P1N8A8005	1624528	66
SH-8EPC58AAD00S	1621565	120	SL-1CKP010	1607911	175	SM-Z0004	1607937	179	ST-17P1N8A8005S	1624529	66
SH-8EPC58AH000S	1627205	120	SL-1CKP020	1607912	175	SM-Z0012	1614349	176	ST-17P1N8A8K02S	1618682	64
SH-8EPC58AWA00S	1621569	119	SL-1CKP030	1607913	175	SM-Z0025	1620558	180	ST-17P1N8A8K03S	1618683	64
SH-8EPS48A8LB1	1622016	118	SL-1CKP040	1607914	175	SM-Z0026	1620559	180	ST-17P1N8A8K04S	1618684	64
SH-8EPS48A8LB1S	1621538	118	SL-1CKP050	1607915	175	SM-Z0027	1620560	180	ST-17P1N8A9003S	1607630	67
SH-8EPS48A8LB2	1622015	118	SL-1CKS010	1607916	175	SM-Z0028	1620627	180	ST-17P1N8A9004S	1607631	67
SH-8EPS48A8LB2S	1621537	118	SL-1CKS020	1607917	175	SM-Z0029	1620628	180	ST-17P1N8A9005S	1624530	67
SH-8EPS48A8LB3	1622014	118	SL-1CKS030	1607918	175	SM-Z0030	1620629	180	ST-17P1N8A9K02S	1613497	64
SH-8EPS48A8LB3S	1621536	118	SL-1CKS040	1607919	175	SM-Z0031	1624199	181	ST-17P1N8A9K03S	1613896	64
SH-8EPS48A8LB4	1622013	118	SL-1CKS050	1607920	175	SM-Z0077	1627218	182	ST-17P1N8A9K04S	1614532	64
SH-8EPS48A8LB4S	1621535	118	SL-5EP1N8A9001	1607499	174	ST-06KP010	1607577	70	ST-17P1N8AA400S	1620441	68
SH-8EPS48A8LDL	1622012	118	SL-5EP1N8A9002	1607500	174	ST-06KP020	1607578	70	ST-17P1N8AA500S	1620458	68
SH-8EPS48A8LDLS	1621534	118	SL-5EPWN8AWA00	1615686	174	ST-06KP030	1607579	70	ST-17P1N8ACK02S	1617863	65
SH-8EPS48A9LB1S	1621558	119	SL-5ES1N8A8001	1607501	174	ST-06KS010	1607580	70	ST-17P1N8ACK03S	1617872	65
SH-8EPS48A9LB2S	1621557	119	SL-5ES1N8A8002	1607503	174	ST-06KS020	1607581	70	ST-17P1N8ACK04S	1617873	65
SH-8EPS48A9LB3S	1621556	119	SL-7EP1N8A9001	1607505	174	ST-06KS030	1607582	70	ST-17P1N8AH100S	1613541	69
SH-8EPS48A9LB4S	1621555	119	SL-7EP1N8A9002	1607506	174	ST-08P1N8A6100S	1618584	69	ST-17P1N8AW400S	1607634	65
SH-8EPS48A9LDLS	1621554	119	SL-7EPWN8AWA00	1615687	174	ST-08P1N8A8003	1618995	66	ST-17P1N8AW500S	1619225	67
SH-8EPS48AA000S	1621562	120	SL-7ES1N8A8001	1607507	174	ST-08P1N8A8003S	1618996	66	ST-17P1N8AWK00S	1619202	67
SH-8EPS48AA000S	1621566	120	SL-7ES1N8A8002	1607508	174	ST-08P1N8A8004	1618996	66	ST-17P1N8AWQ00S	1607636	65
SH-8EPS48AH000S	1627206	120	SL-Z0005	1607926	181	ST-08P1N8A8004S	1619000	66	ST-17S1N8A6100S	1613542	69
SH-8EPS48AWA00S	1621570	119	SL-Z0007	1613484	178	ST-08P1N8A8005	1618997	66	ST-17S1N8A8003	1607641	66
SH-8ESC58A8LB1	1622001	118	SL-Z0008	1613485	178	ST-08P1N8A8005S	1619001	66	ST-17S1N8A8003S	1607642	66
SH-8ESC58A8LB1S	1621523	118	SL-Z0010	1613487	178	ST-08P1N8A8K02S	1618641	64	ST-17S1N8A8004	1607643	66
SH-8ESC58A8LB2	1622000	118	SL-Z0011	1613488	178	ST-08P1N8A8K03S	1618648	64	ST-17S1N8A8004S	1607644	66
SH-8ESC58A8LB2S	1621522	118	SL-Z0012	1613489	178	ST-08P1N8A8K04S	1618649	64	ST-17S1N8A8005	1624531	66
SH-8ESC58A8LB3	1621999	118	SL-Z0013	1613490	178	ST-08P1N8A9003S	1619011	67	ST-17S1N8A8005S	1624532	66
SH-8ESC58A8LB3S	1621521	118	SL-Z0014	1613491	178	ST-08P1N8A9004S	1619012	67	ST-17S1N8A8K02S	1613288	64
SH-8ESC58A8LB4	1621998	118	SL-Z0015	1613492	178	ST-08P1N8A9005S	1619013	67	ST-17S1N8A8K03S	1613324	64
SH-8ESC58A8LB4S	1621520	118	SL-Z0016	1614348	176	ST-08P1N8A9K02S	1617799	64	ST-17S1N8A8K04S	1613325	64
SH-8ESC58A8LDL	1621997	118	SM-20KP005	1605736	169	ST-08P1N8A9K03S	1617813	64	ST-17S1N8A9003S	1607647	67
SH-8ESC58A8LDLS	1621517	118	SM-20KP006	1605738	169	ST-08P1N8A9K04S	1617830	64	ST-17S1N8A9004S	1607649	67
SH-8ESC58A9LB1S	1621543	119	SM-20KP007	1605739	169	ST-08P1N8AA400S	1620439	68	ST-17S1N8A9005S	1624533	67
SH-8ESC58A9LB2S	1621542	119	SM-20KP008	1605741	169	ST-08P1N8AA500S	1620456	68	ST-17S1N8A9K02S	1618756	64
SH-8ESC58A9LB3S	1621541	119	SM-36KP001	1605743	169	ST-08P1N8ACK02S	1617925	65	ST-17S1N8A9K03S	1618757	64
SH-8ESC58A9LB4S	1621540	119	SM-36KP003	1605745	169	ST-08P1N8ACK03S	1617929	65	ST-17S1N8A9K04S	1618758	64
SH-8ESC58A9LDLS	1621539	119	SM-36KP004	1605747	169	ST-08P1N8ACK04S	1617932	65	ST-17S1N8AA400S	1620442	68
SH-8ESC58AAC00S	1621559	120	SM-36KP005	1605749	169	ST-08P1N8AH100S	1619034	69	ST-17S1N8AA500S	1620457	68
SH-8ESC58AAD00S	1621563	120	SM-36KP006	1605750	169	ST-08P1N8AW400S	1619037	65	ST-17S1N8ACK02S	1618834	65
SH-8ESC58AH000S	1624344	120	SM-36KP007	1605752	169	ST-08P1N8AW500S	1619219	67	ST-17S1N8ACK03S	1618835	65
SH-8ESC58AWA00S	1621567	119	SM-36KP008	1605754	169	ST-08P1N8AWK00S	1619196	67	ST-17S1N8ACK04S	1618836	65
SH-8ESS48A8LB1	1622006	118	SM-36KP009	1607057	169	ST-08P1N8AWQ00S	1613286	65	ST-17S1N8AH100S	1613543	69
SH-8ESS48A8LB1S	1621528	118	SM-36KP016	1623970	169	ST-08S1N8A6100S	1619036	69	ST-17S1N8AW400S	1607653	65
SH-8ESS48A8LB2	1622005	118	SM-36KS001	1605756	169	ST-08S1N8A8003	1619003	66	ST-17S1N8AW500S	1619226	67
SH-8ESS48A8LB2S	1621527	118	SM-36KS002	1605758	169	ST-08S1N8A8003S	1619007	66	ST-17S1N8AWK00S	1619206	67
SH-8ESS48A8LB3	1622004	118	SM-36KS003	1605760	169	ST-08S1N8A8004	1619004	66	ST-17S1N8AWQ00S	1607654	65
SH-8ESS48A8LB3S	1621526	118	SM-36KS004	1605762	169	ST-08S1N8A8004S	1619008	66	ST-20KP010	1607655	140
SH-8ESS48A8LB4	1622003	118	SM-36KS016	1623972	169	ST-08S1N8A8005	1619005	66	ST-20KP020	1607656	140
SH-8ESS48A8LB4S	1621525	118	SM-5EP1N8A9L32S	1613425	166	ST-08S1N8A8005S	1619009	66	ST-20KS010	1607657	140
SH-8ESS48A8LDL	1622002	118	SM-5EP1N8A9L33S	1613426	166	ST-08S1N8A8K02S	1613370	64	ST-20KS020	1607658	140
SH-8ESS48A8LDLS	1621524	118	SM-5EP1N8A9L34S	1613427	166	ST-08S1N8A8K03S	1613371	64	ST-3EP1N8A6100S	1613544	139
SH-8ESS48A9LB1S	1621548	119	SM-5EPWN8AA700	1620663	168	ST-08S1N8A8K04S	1613372	64	ST-3EP1N8A8003	1607663	136
SH-8ESS48A9LB2S	1621547	119	SM-5EPWN8AWT00	1613517	166	ST-08S1N8A9003S	1619015	67	ST-3EP1N8A8003S	1607665	136
SH-8ESS48A9LB3S	1621546	119	SM-5ES1N8A8L32S	1613428	166	ST-08S1N8A9004S	1619016	67	ST-3EP1N8A8004	1607666	136
SH-8ESS48A9LB4S	1621545	119	SM-5ES1N8A8L33S	1613429	166	ST-08S1N8A9005S	1619017	67	ST-3EP1N8A8004S	1607667	136
SH-8ESS48A9LDLS	1621544	119	SM-5ES1N8A8L34S	1613430	166	ST-08S1N8A9K02S	1618724	64	ST-3EP1N8A8005	1624534	136
SH-8ESS48AAC00S	1621560	120	SM-5ES1N8A8S22	1613518	166	ST-08S1N8A9K03S	1618725	64	ST-3EP1N8A8005S	1624535	136
SH-8ESS48AAD00S	1621564	120	SM-5ES1N8A8S23	1613519	166	ST-08S1N8A9K04S	1618726	64	ST-3EP1N8A8K02S	1618602	134
SH-8ESS48AH000S	1627204	120	SM-5ES1N8A8S24	1613520	166	ST-08S1N8AA400S	1620440	68	ST-3EP1N8A8K03S	1618574	134
SH-8ESS48AWA00S	1621568	119	SM-5ES1N8AY000	1605823	167	ST-08S1N8AA500S	1620455	68	ST-3EP1N8A8K04S	1618575	134
SH-Z2007	1627226	182	SM-5ES1N8AY000S	1613524	167	ST-08S1N8ACK02S	1618801	65	ST-3EP1N8A9003S	1607670	137
SH-Z2300	1622141	182	SM-5ES1N8AYW00	1607532	167	ST-08S1N8ACK03S	1618802	65	ST-3EP1N8A9004S	1607671	137
SH-Z2301	1622140	182	SM-5ES1N8AYW00S	1613525	167	ST-08S1N8ACK04S	1618805	65	ST-3EP1N8A9005S	1624536	137
SH-Z2302	1622139	182	SM-7EP1N8A9L32S	161343							

Type	Order No.	Page	Type	Order No.	Page	Type	Order No.	Page	Type	Order No.	Page
ST-3EP1N8ACK02S	1618402	135	ST-5ES1N8ACK04S	1618774	135	ST-7EP1N8AW400S	1607746	135	ST-8ES1N8AWK00S	1620459	137
ST-3EP1N8ACK03S	1618407	135	ST-5ES1N8AH100S	1613551	139	ST-7EP1N8AW500S	1619217	137	ST-8ES1N8AWQ00S	1613631	135
ST-3EP1N8ACK04S	1618760	135	ST-5ES1N8AW400S	1607727	135	ST-7EP1N8AWK00S	1619194	137	ST-E2015151	1613831	69
ST-3EP1N8AH100S	1613545	139	ST-5ES1N8AW500S	1619214	137	ST-7EP1N8AWQ00S	1607747	135	ST-Z0001	1607770	179
ST-3EP1N8AW400S	1607674	135	ST-5ES1N8AWK00S	1619191	137	ST-7ES1N8A6100S	1613592	139	ST-Z0002	1607771	179
ST-3EP1N8AW500S	1619209	137	ST-5ES1N8AWQ00S	1607728	135	ST-7ES1N8A8003	1607755	136	ST-Z0003	1607772	179
ST-3EP1N8AWK00S	1619186	137	ST-6EP1N8A6100S	1613553	139	ST-7ES1N8A8003S	1607756	136	ST-Z0004	1607773	179
ST-3EP1N8AWQ00S	1607675	135	ST-6EP1N8A8003	1613558	136	ST-7ES1N8A8004	1607758	136	ST-Z0005	1607775	179
ST-3ES1N8A6100S	1613546	139	ST-6EP1N8A8003S	1613559	136	ST-7ES1N8A8004S	1607759	136	ST-Z0006	1607776	181
ST-3ES1N8A8003	1607682	136	ST-6EP1N8A8004	1613560	136	ST-7ES1N8A8005	1624555	136	ST-Z0007	1607777	181
ST-3ES1N8A8003S	1607683	136	ST-6EP1N8A8004S	1613561	136	ST-7ES1N8A8005S	1624556	136	ST-Z0012	1613667	176
ST-3ES1N8A8004	1607684	136	ST-6EP1N8A8005	1624546	136	ST-7ES1N8A8K02S	1618633	134	ST-Z0013	1616068	182
ST-3ES1N8A8004S	1607685	136	ST-6EP1N8A8005S	1624547	136	ST-7ES1N8A8K03S	1618634	134	ST-Z0014	1616099	182
ST-3ES1N8A8005	1624537	136	ST-6EP1N8A8K02S	1618622	134	ST-7ES1N8A8K04S	1618635	134	ST-Z0016	1617993	180
ST-3ES1N8A8005S	1624538	136	ST-6EP1N8A8K03S	1618623	134	ST-7ES1N8A9003S	1607764	137	ST-Z0017	1618049	180
ST-3ES1N8A8K02S	1618312	134	ST-6EP1N8A8K04S	1618624	134	ST-7ES1N8A9004S	1607765	137	ST-Z0018	1618050	180
ST-3ES1N8A8K03S	1618408	134	ST-6EP1N8A9003S	1613564	137	ST-7ES1N8A9005S	1624557	137	ST-Z0019	1620621	180
ST-3ES1N8A8K04S	1618603	134	ST-6EP1N8A9004S	1613565	137	ST-7ES1N8A9K02S	1618716	134	ST-Z0020	1620622	180
ST-3ES1N8A9003S	1607688	137	ST-6EP1N8A9005S	1624548	137	ST-7ES1N8A9K03S	1618717	134	ST-Z0021	1620623	180
ST-3ES1N8A9004S	1607689	137	ST-6EP1N8A9K02S	1618704	134	ST-7ES1N8A9K04S	1618718	134	ST-Z0023	1621049	181
ST-3ES1N8A9005S	1624539	137	ST-6EP1N8A9K03S	1618705	134	ST-7ES1N8AA400S	1620436	138	ST-Z0024	1621904	181
ST-3ES1N8A9K02S	1618695	134	ST-6EP1N8A9K04S	1618706	134	ST-7ES1N8AA500S	1620451	138	ST-Z0077	1627217	182
ST-3ES1N8A9K03S	1618694	134	ST-6EP1N8AA400S	1620433	138	ST-7ES1N8ACK02S	1618787	135	SZK PZ1 VDE	1206450	313
ST-3ES1N8A9K04S	1618693	134	ST-6EP1N8AA500S	1620450	138	ST-7ES1N8ACK03S	1618786	135	SZK PZ2 VDE	1206463	310
ST-3ES1N8AA400S	1620428	138	ST-6EP1N8ACK02S	1618776	135	ST-7ES1N8ACK04S	1618785	135	SZS 0,4X2,0	1205202	312
ST-3ES1N8AA500S	1620443	138	ST-6EP1N8ACK03S	1618777	135	ST-7ES1N8AH100S	1613593	139			
ST-3ES1N8ACK02S	1618762	135	ST-6EP1N8ACK04S	1618778	135	ST-7ES1N8AW400S	1607768	135			
ST-3ES1N8ACK03S	1618763	135	ST-6EP1N8AH100S	1613568	139	ST-7ES1N8AW500S	1619218	137			
ST-3ES1N8ACK04S	1618764	135	ST-6EP1N8AW400S	1613569	135	ST-7ES1N8AWK00S	1619195	137			
ST-3ES1N8AH100S	1613547	139	ST-6EP1N8AW500S	1619215	137	ST-7ES1N8AWQ00S	1607769	135			
ST-3ES1N8AW400S	1607692	135	ST-6EP1N8AWK00S	1619192	137	ST-8EP1N8A6100S	1613595	139			
ST-3ES1N8AW500S	1619212	137	ST-6EP1N8AWQ00S	1613570	135	ST-8EP1N8A8003	1613600	136			
ST-3ES1N8AWK00S	1619189	137	ST-6ES1N8A6100S	1613572	139	ST-8EP1N8A8003S	1613601	136	TF-SCRJ-POF KONF SET	1405246	384
ST-3ES1N8AWQ00S	1607694	135	ST-6ES1N8A8003	1613577	136	ST-8EP1N8A8004	1613602	136	TMT 5 R	0816430	373
ST-5EP1N8A6100S	1613548	139	ST-6ES1N8A8003S	1613578	136	ST-8EP1N8A8004S	1613603	136	TSD 02 SAC	1208487	306
ST-5EP1N8A8003	1607699	136	ST-6ES1N8A8004	1613579	136	ST-8EP1N8A8005	1624636	136	TSD 04 SAC	1208429	57
ST-5EP1N8A8003S	1607700	136	ST-6ES1N8A8004S	1613580	136	ST-8EP1N8A8005S	1624637	136	TSD 08 SAC	1212597	57
ST-5EP1N8A8004	1607701	136	ST-6ES1N8A8005	1624549	136	ST-8EP1N8A8K02S	1618681	134	TSD 20 SAC	1212020	315
ST-5EP1N8A8004S	1607702	136	ST-6ES1N8A8005S	1624550	136	ST-8EP1N8A8K03S	1618680	134	TSD 25 SAC	1212315	310
ST-5EP1N8A8005	1624540	136	ST-6ES1N8A8K02S	1618632	134	ST-8EP1N8A8K04S	1618679	134	TSD-M 1,2NM	1212224	57
ST-5EP1N8A8005S	1624541	136	ST-6ES1N8A8K03S	1618631	134	ST-8EP1N8A9003S	1613606	137	TSD-M 3NM	1212225	57
ST-5EP1N8A8K02S	1618614	134	ST-6ES1N8A8K04S	1618630	134	ST-8EP1N8A9004S	1613607	137	TSD-M 6NM	1212226	57
ST-5EP1N8A8K03S	1618615	134	ST-6ES1N8A9003S	1613583	137	ST-8EP1N8A9005S	1624653	137	TSD-M SAC-BIT ADAPTER	1212600	57
ST-5EP1N8A8K04S	1618616	134	ST-6ES1N8A9004S	1613584	137	ST-8EP1N8A9K02S	1618740	134			
ST-5EP1N8A9003S	1607706	137	ST-6ES1N8A9005S	1624551	137	ST-8EP1N8A9K03S	1618741	134	UC-EM (17,5X9)	0827490	312
ST-5EP1N8A9004S	1607707	137	ST-6ES1N8A9K02S	1618708	134	ST-8EP1N8A9K04S	1618742	134	UC-EM (17,5X9) CUS	0828238	312
ST-5EP1N8A9005S	1624542	137	ST-6ES1N8A9K03S	1618709	134	ST-8EP1N8AA400S	1620437	138	UC-EM (17,5X9) YE	0827494	312
ST-5EP1N8A9K02S	1618703	134	ST-6ES1N8A9K04S	1618710	134	ST-8EP1N8AA500S	1620454	138	UC-EM (17,5X9) YE CUS	0828239	312
ST-5EP1N8A9K03S	1618702	134	ST-6ES1N8AA400S	1620434	138	ST-8EP1N8ACK02S	1618818	135	UC-TMF 5	0818153	373
ST-5EP1N8A9K04S	1618701	134	ST-6ES1N8AA500S	1620449	138	ST-8EP1N8ACK03S	1618819	135	UC-TMF 8	0818137	714
ST-5EP1N8AA400S	1620431	138	ST-6ES1N8ACK02S	1618780	135	ST-8EP1N8ACK04S	1618820	135	UC-TMF 16	0827494	714
ST-5EP1N8AA500S	1620448	138	ST-6ES1N8ACK03S	1618781	135	ST-8EP1N8AH100S	1613610	139	UC-TMF 16YE	0819259	314
ST-5EP1N8ACK02S	1618767	135	ST-6ES1N8ACK04S	1618782	135	ST-8EP1N8AW400S	1613611	135	UCT-EM (7X10)	0830765	301
ST-5EP1N8ACK03S	1618768	135	ST-6ES1N8AH100S	1613587	139	ST-8EP1N8AW500S	1620462	137	UNIFOX MT-CK 1.6/2.5	1089092	669
ST-5EP1N8ACK04S	1618769	135	ST-6ES1N8AW400S	1613588	135	ST-8EP1N8AWK00S	1620460	137	UNIFOX RT-CK 1.6	1072069	670
ST-5EP1N8AH100S	1613549	139	ST-6ES1N8AW500S	1619216	137	ST-8EP1N8AWQ00S	1613612	135	UNIFOX RT-CK 2.5	1072067	670
ST-5EP1N8AW400S	1607710	135	ST-6ES1N8AWK00S	1619193	137	ST-8ES1N8A6100S	1613614	139	UNIFOX RT-CK 4.0	1072064	670
ST-5EP1N8AW500S	1619213	137	ST-6ES1N8AWQ00S	1613589	135	ST-8ES1N8A8003	1613619	136	UNIFOX-WP	1212365	659
ST-5EP1N8AWK00S	1619190	137	ST-7EP1N8A6100S	1613590	139	ST-8ES1N8A8003S	1613620	136	USS 4	1203149	708
ST-5EP1N8AWQ00S	1607711	135	ST-7EP1N8A8003	1607735	136	ST-8ES1N8A8004	1613621	136			
ST-5ES1N8A6100S	1613550	139	ST-7EP1N8A8003S	1607736	136	ST-8ES1N8A8004S	1613622	136			
ST-5ES1N8A8003	1607717	136	ST-7EP1N8A8004	1607737	136	ST-8ES1N8A8005	1624638	136			
ST-5ES1N8A8003S	1607718	136	ST-7EP1N8A8004S	1607738	136	ST-8ES1N8A8005S	1624639	136			
ST-5ES1N8A8004	1607719	136	ST-7EP1N8A8005	1624552	136	ST-8ES1N8A8K02S	1618674	134			
ST-5ES1N8A8004S	1607720	136	ST-7EP1N8A8005S	1624553	136	ST-8ES1N8A8K03S	1618675	134			
ST-5ES1N8A8005	1624543	136	ST-7EP1N8A8K02S	1618640	134	ST-8ES1N8A8K04S	1618676	134			
ST-5ES1N8A8005S	1624544	136	ST-7EP1N8A8K03S	1618639	134	ST-8ES1N8A9003S	1613625	137			
ST-5ES1N8A8K02S	1618621	134	ST-7EP1N8A8K04S	1618638	134	ST-8ES1N8A9004S	1613626	137			
ST-5ES1N8A8K03S	1618620	134	ST-7EP1N8A9003S	1607741	137	ST-8ES1N8A9005S	1624654	137	VS-04-2X2X26C7/7-67A/67B/2,0	1653870	452
ST-5ES1N8A8K04S	1618619	134	ST-7EP1N8A9004S	1607742	137	ST-8ES1N8A9K02S	1618748	134	VS-04-2X2X26C7/7-67A/67B/5,0	1653883	452
ST-5ES1N8A9003S	1607723	137	ST-7EP1N8A9005S	1624554	137	ST-8ES1N8A9K03S	1618749	134	VS-04-2X2X26C7/7-67A/OE/1,0	1655742	452
ST-5ES1N8A9004S	1607724	137	ST-7EP1N8A9K02S	1618712	134	ST-8ES1N8A9K04S	1618750	134	VS-04-2X2X26C7/7-67A/OE/2,0	1655755	452
ST-5ES1N8A9005S	1624545	137	ST-7EP1N8A9K03S	1618713	134	ST-8ES1N8AA400S	1620438	138	VS-04-2X2X26C7/7-67A/OE/5,0	1655768	452
ST-5ES1N8A9K02S	1618696	134	ST-7EP1N8A9K04S	1618714	134	ST-8ES1N8AA500S	1620453	138	VS-04-2X2X26C7/7-67A/SDB/2,0	1653896	452
ST-5ES1N8A9K03S	1618697	134	ST-7EP1N8AA400S	1620435	138	ST-8ES1N8ACK02S	1618825	135	VS-04-2X2X26C7/7-67A/SDB/5,0	1653906	452
ST-5ES1N8A9K04S	1618698	134	ST-7EP1N8AA500S	1620452	138	ST-8ES1N8ACK03S	1618824	135	VS-04-2X2X2		

Index

Alphabetical

Type	Order No.	Page	Type	Order No.	Page	Type	Order No.	Page	Type	Order No.	Page
VS-04-2X2X26C7/7-SDA/SDB/1,0	1654853	452	VS-FP-SD-GB-RJ456A-BUBU	1054544	713	VS-PPC-C1-RJ45-POBK-810G	1422205	358			
VS-04-2X2X26C7/7-SDA/SDB/2,0	1653935	452	VS-FSBPXS-OE-94F/0,5	1424135	403	VS-PPC-C1-RJ45-POBK-PG9-4Q5	1608126	358			
VS-04-2X2X26C7/7-SDA/SDB/5,0	1653948	452	VS-FSBPXS-OE-94F/1,0	1424148	403	VS-PPC-C1-RJ45-POBK-PG9-4Q5-OL	1404142	358			
VS-04-BUA-FK-F/1P67	1653854	453	VS-FSBPXS-OE-94F/2,0	1424151	403	VS-PPC-C1-RJ45-POBK-PG9-8Q5	1657834	358			
VS-04-BUB-FK-F/1P67	1653867	453	VS-FSBPXS-OE-94F/5,0	1424164	403	VS-PPC-F1-PC-POBK	1405316	358			
VS-04-C-SDA/PH/0,3	1405552	453	VS-FSBPYS-OE-94H/0,5 SCO	1407504	405	VS-PPC-F1-RJ45-MNNA-1C-F	1405222	360			
VS-04-C-SDA/SDB/1,8	1405578	453	VS-FSBPYS-OE-94H/1,0 SCO	1407505	405	VS-PPC-F1-RJ45-MNNA-1R-F	1405358	360			
VS-04-C-SDB/PH/0,3	1405565	453	VS-FSBPYS-OE-94H/2,0 SCO	1407506	405	VS-PPC-F1-SCRJ-MNNA-1C-F	1405235	369			
VS-08-A-RJ45/MOD-1-IP20	1689433	374	VS-FSBPYS-OE-94H/5,0 SCO	1407507	405	VS-PPC-F2-MSTB-MNNA-1C-SPSA5	1405248	364			
VS-08-A-RJ45/MOD-1-IP67	1689080	351	VS-FSDB-IP20SDA/981/1,0 SCO	1420168	452	VS-PPC-F2-MSTB-MNNA-1R-P	1608087	364			
VS-08-A-RJ45/MOD-1-IP67-BK	1658642	351	VS-FSDB-IP20SDA/981/2,0 SCO	1420171	452	VS-PPC-F2-MSTB-MNNA-1R-SPSA5	1608249	364			
VS-08-A-RJ45/MOD-1-R-IP67	1689844	351	VS-FSDB-IP20SDA/981/5,0 SCO	1420184	452	VS-PPC-F2-PC-POBK	1405329	364			
VS-08-A-RJ45-5-F/1P67 BK	1658053	351	VS-GC-RJ456A-BUBU	1055552	713	VS-PPC-J-1-SCRJ-MNBK	1405206	371			
VS-08-BU-RJ45-5-MPK	1652936	351	VS-GC-USBA3-A-BUBU	1055554	713	VS-PPC-J-1220-1227-1020-...	1405484	365			
VS-08-BU-RJ45-6-MOD/BU	1653155	351	VS-IET-DSUB-SIGNAL-HD	1658503	446	VS-PPC-J-1220-1227-1020-0,2	1404799	365			
VS-08-BU-RJ45/BU	1689064	351	VS-IET-DSUB-SIGNAL-STD	1658794	446	VS-PPC-J-4X-1227	1405387	365			
VS-08-KS-H/GN	1654756	372	VS-IP20-OE-93E-LI/1,0	1405633	398	VS-PPC-J-M	1405390	365			
VS-08-KS-H/GY	1654743	372	VS-IP20-OE-94B-LI/5,0	1407699	400	VS-PPC/ME-IP20-93B-LI/5,0	1416138	396			
VS-08-KU-IP67	1689268	353	VS-IP20/10G-IP20/10G-94F/1	1418866	402	VS-PPC/ME-IP20-93E-LI/5,0	1405992	398			
VS-08-KU-IP67-BK	1658684	353	VS-IP20/10G-IP20/10G-94F/5	1418879	402	VS-PPC/ME-IP20-94B-LI/5,0	1407990	400			
VS-08-M12MR-10G-P SCO	1417443	342	VS-IP67-IP20-93E-LI/2,0	1405921	398	VS-PPC/ME-OE-93E-LI/5,0	1405743	398			
VS-08-M12MS-10G-P SCO	1417430	342	VS-IP67-IP20-94B-LI/5,0	1407932	400	VS-PPC/ME-OE-94B-LI/5,0	1407783	400			
VS-08-RJ45-10G/C	1418853	350	VS-IP67-OE-93E-LI/2,0	1405675	398	VS-PPC/PL-IP20-93B-LI/5,0	1416141	397			
VS-08-RJ45-10G/Q	1419001	372	VS-IP67-OE-94B-LI/5,0	1407725	400	VS-PPC/PL-IP20-93E-LI/5,0	1406030	399			
VS-08-RJ45-5-Q/1P20	1656725	372	VS-M12FSBP-IP20-93E-LI/2,0	1406085	399	VS-PPC/PL-IP20-94B-LI/5,0	1412024	401			
VS-08-RJ45-5-Q/1P20 BK	1658008	372	VS-M12FSBP-IP20-94B-LI/5,0	1412082	401	VS-PPC/PL-OE-93E-LI/5,0	1405772	399			
VS-08-RJ45-5-Q/1P67	1656990	350	VS-M12FSBP-IP67-93E-LI/2,0	1406247	399	VS-PPC/PL-OE-94B-LI/5,0	1407819	401			
VS-08-RJ45-5-Q/1P67-BK	1658493	350	VS-M12FSBP-OE-93E-LI/2,0	1405866	399	VS-SCRJ-A-TC-IP67	1658545	354			
VS-08-RJ45-FOLIEN-SET	1417184	358	VS-M12FSBP-OE-94B-LI/5,0	1407877	401	VS-SCRJ-GOF-BU/BU	1652978	354			
VS-08-SD-F	1652606	453	VS-M12FSBP-PPC/ME-93E-LI/2,0	1406519	399	VS-SCRJ-GOF-KU	1654358	380			
VS-08-SD-F-BK	1658066	351	VS-M12FSBP-PPC/ME-94B-LI/5,0	1412503	401	VS-SCRJ-HCS-FA-IP20	1654866	376			
VS-08-ST-H11-RJ45	1652716	350	VS-M12FSBP-PPC/PL-93E-LI/2,0	1406603	399	VS-SCRJ-PC	1653757	354			
VS-08-ST-H21-RJ45	1652729	350	VS-M12FSBP-PPC/PL-94B-LI/5,0	1412590	401	VS-SCRJ-POF-FA-IP20	1654879	376			
VS-08-ST-H21P-RJ45	1404388	350	VS-MP-PPC/CG-10G	1403678	361	VS-SCRJ-POF-FA-IP67	1657009	354			
VS-08-T-H-RJ45/1P67	1652732	350	VS-MP-PPC/CG-F0	1404319	370	VS-SI-EB-EMV-1	1656482	708			
VS-08-T-H-RJ45/1P67-BK	1658671	350	VS-MP-PPC/CG-PO	1403681	361	VS-SI-EB-EMV-2	1656495	708			
VS-09-A	1688366	444	VS-MP-PPC/CG-PO/10G	1403682	361	VS-SI-FP-2DSUB15	1656592	712			
VS-09-A-EMV-S	1688463	444	VS-MP-PPC/CG-PO/F0	1404321	370	VS-SI-FP-2DSUB25	1656115	712			
VS-09-A-GC-BU/BU	1689695	445	VS-MP-PPC/PPC-1G	1403685	362	VS-SI-FP-2DSUB9	1656563	712			
VS-09-A-GC-ST/ST	1689705	445	VS-MP-PPC/PPC-PO	1403684	362	VS-SI-FP-2DSUB9-GC-BU/ST	1657708	710			
VS-09-BU-DSUB/9-MPT-0,5	1688395	445	VS-MP-PPC/PPC-PO/1G	1406395	361	VS-SI-FP-2RJ-MOD	1656631	709			
VS-09-CAN	1689307	444	VS-MSTBAH 2,5/ 5-GB-5,08-BK-A	1657915	364	VS-SI-FP-2RJ45-5-MOD-BU/BU	1657766	709			
VS-09-GC-BU/BU	1688722	712	VS-MSTBVA 2,5/ 5-GB-5,08-BK-A	1609565	364	VS-SI-FP-BP	1656657	711			
VS-09-IBS-BU	1689284	444	VS-OE-OE-937/...	1402887	392	VS-SI-FP-DSUB15-DSUB25	1656602	712			
VS-09-IBS-ST	1689271	444	VS-OE-OE-93A-100,0	1416392	392	VS-SI-FP-DSUB9-DSUB15	1656576	712			
VS-09-KU-BU/BU	1689637	445	VS-OE-OE-93B-100,0	1416389	392	VS-SI-FP-DSUB9-DSUB25	1656589	712			
VS-09-KU-ST/ST	1689640	445	VS-OE-OE-93B/...	1417362	392	VS-ST-LH-3,6/18/3,8	1655467	447			
VS-09-PROFIBUS-SC	1654549	444	VS-OE-OE-93C-100,0	1416376	392	VS-ST-LK-3,6/22,4/2,6	1688243	447			
VS-09-PROFIBUS-SP	1654345	444	VS-OE-OE-93C/...	1417491	392	VS-ST-LK-3,6/22,4/4,6	1688269	447			
VS-09-SET-EMV	1689158	444	VS-OE-OE-93E-100,0	1416295	393	VS-ST-SC-2,6	1655483	447			
VS-09-ST-DSUB/10-MPT-0,5	1688379	445	VS-OE-OE-93E/...	1417320	393	VS-TO-RO-MCBK-F1411/1411	1404281	363			
VS-15-GC-BU/BU	1652664	712	VS-OE-OE-93R-100,0	1416363	392	VS-TO-RO-MCBK-F1411/1413	1404333	363			
VS-25-GC-BU/BU	1652680	712	VS-OE-OE-93R/...	1417388	392	VS-TO-RO-MCBK-F1417/1413	1404346	371			
VS-93A/...	1416486	392	VS-OE-OE-94A-100,0	1416305	393	VS-TO-RO-MCBK-F1417/1417	1404320	371			
VS-94A/...	1416415	393	VS-OE-OE-94B-100,0	1416567	393	VS-TO-RO-MCBK-F1418/1418	1404278	352			
VS-94D/...	1416444	393	VS-OE-OE-94B/...	1417333	393	VS-TO-RO-MCBK-F1420/1420	1404317	355			
VS-94E/...	1416460	393	VS-OE-OE-94C-100,0	1416318	393	VS-TO-RO-MCBK-F1421/1421	1404294	349			
VS-A-F-IP67	1653744	351	VS-OE-OE-94C/...	1417346	393	VS-TO-RO-MCBK-F1422/1422	1404304	349			
VS-A-F-IP67-BK	1658668	351	VS-OE-OE-94D-100,0	1416334	393						
VS-ASI-FC-EPDM-BK 100M	1432415	438	VS-OE-OE-94E-100,0	1416350	393						
VS-ASI-FC-EPDM-YE 100M	1432402	438	VS-OE-OE-94F-100,0	1416347	393						
VS-ASI-FC-PUR-BK 100M	1404896	438	VS-OE-OE-94F/...	1417359	393						
VS-ASI-FC-PUR-YE 100M	1404883	438	VS-OE-PPC/ME-93B-LI/5,0	1416162	396						
VS-ASI-FC-PVC-UL-BK 100M	1404919	438	VS-OE-PPC/PL-93B-LI/5,0	1416168	397						
VS-ASI-FC-PVC-UL-YE 100M	1404906	438	VS-P1220-P1220-C1020/ 1,0	1609170	366						
VS-ASI-FC-TPE-UL-BK 100M	1404935	438	VS-P1220-P1220-C1020/ 2,0	1609183	366	WIREFOX-PN POF	1405249	384			
VS-ASI-FC-TPE-UL-YE 100M	1404922	438	VS-P1220-P1220-C1020/ 5,0	1609196	366						
VS-ASI-J-Y-N-M12FS-LC	1433155	440	VS-P1220-P1220-C1020/...	1609206	366						
VS-ASI-J-Y-N-SWA-LC	1433168	440	VS-PN-RJ45-5-Q/1P20	1658435	372						
VS-BH-M12FSX-10G-RJ45/180	1404549	348	VS-PNRJ45-PNRJ45R-93B-1,0	1418248	396						
VS-BH-M12FSX-10G-RJ45/90	1404548	348	VS-PNRJ45-PNRJ45R-93B-2,0	1418277	396						
VS-BU-LH-3,6/18/3,8	1655454	447	VS-PP-19-1HE-16-F	1652994	391						
VS-BU-LK-3,6/22,8/2,6	1688256	447	VS-PP-F-SCRJ	1658121	375	ZBF 16:UNPRINTED	0827464	714			
VS-BU-LK-3,6/22,8/4,6	1688272	447	VS-PPC-C1-MNNA-4Q5-EMC	1403366	359	ZBF 8:UNBEDRUCKT	0808781	441			
VS-BU-SC-2,6	1655470	447	VS-PPC-C1-MNNA-8Q5-EMC	1403367	359	ZBF10 CUS	0825031	310			
VS-CABLE-STRIP-VARIO	1657407	362	VS-PPC-C1-PC-ROBK-L	1405293	360	ZBF10:UNBEDRUCKT	0809997	310			
VS-CT-RJ45-H	1653265	350	VS-PPC-C1-RJ45-MNNA-PG9-4Q5	1608100	359	ZBN 18 CUS	0825059	314			
VS-ES-100-6	1055164	713	VS-PPC-C1-RJ45-MNNA-PG9-4Q5-B	1405141	359	ZBN 18 YE CUS	0825058	314			
VS-FP-SD-D-RJ456A-BUBU	1054542	713	VS-PPC-C1-RJ45-MNNA-PG9-8Q5	1608016	359	ZBN 18:UNBEDRUCKT	2809128	314			
VS-FP-SD-FR-RJ456A-BUBU	1054543	713	VS-PPC-C1-RJ45-MNNA-PG9-8Q5-OL	1404126	359						

W

Z

For up-to-date modifications or supplements
to the catalog contents, please visit:
phoenixcontact.net/webcode/#0132

